

6" PUSH PLATE

PBR SERIES



10PBR1 shown with optional surface mount box
(All mounting options are sold separately)

PREMIUM PUSH PLATE FOR KNOWING ACT APPLICATIONS

DESCRIPTION

The **PBR SERIES** is a standard 6 inch round push plate with a premium design for wall applications, as well as functional, aesthetically appealing and weather resistant.

Hard Wired & Wireless



EN

PBR Series



10PBR
Push To Open
Text Only



10PBRLL
Handicap
Logo Only



10PBR1
Push To Open
Text and Logo



10PBR10
Plain Face
No Graphic

Components View

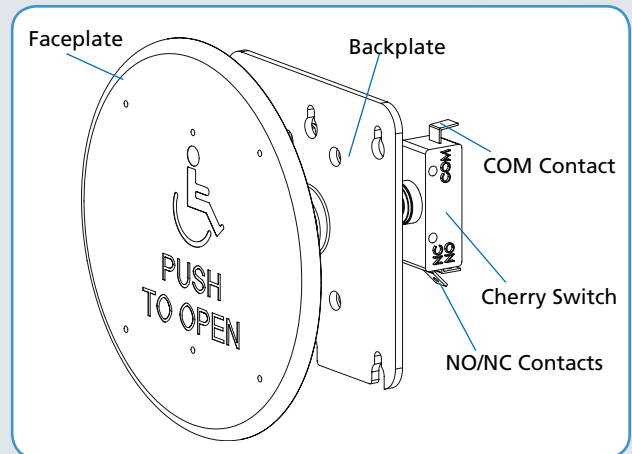

FEATURES

- Larger surface area for high visibility
- Beveled edges are less susceptible to damage by deflecting harsh impacts from any side
- Stainless steel finish is scratch/scuff resistant and will not deteriorate or rust from exposure to liquids and other cleaning agents
- Graphics are etched onto the faceplate for maximum durability
- Available in various styles to fit almost any application, hard wired or wireless

BEA

OPEN UP NEW HORIZONS

APPLICATIONS

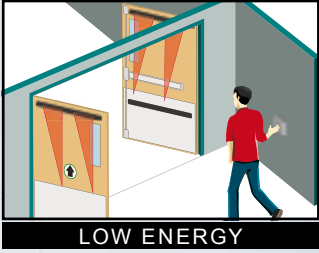

LOW ENERGY

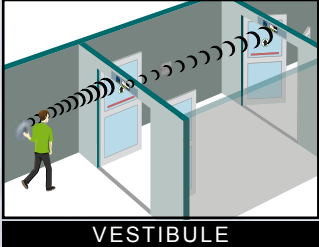

VESTIBULE



REQUEST TO EXIT

BENEFITS

- Grade 304 stainless steel maximizes corrosion resistance and prevents rusting
- Stainless steel materials are 100% recyclable and environmentally friendly
- Options include hard wired and wireless mounting
- Compatible wireless frequencies include 433, 390 or 300 MHz

MOUNTING ACCESSORIES



10BOX6RNDMSM
Surface Mount



10BOX6RNDFM
Flush Mount

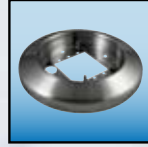

10ESCUTCHEON
Stainless Steel
Surface Mount



10WRRND6
6 inch
Weather Ring

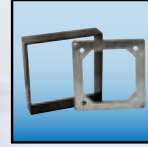

10PBBRACKET
Surface
Mount Kit

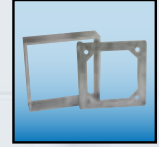

10PBBRACKETCA
Clear Anodized
Surface Mount

DIMENSION DETAILS

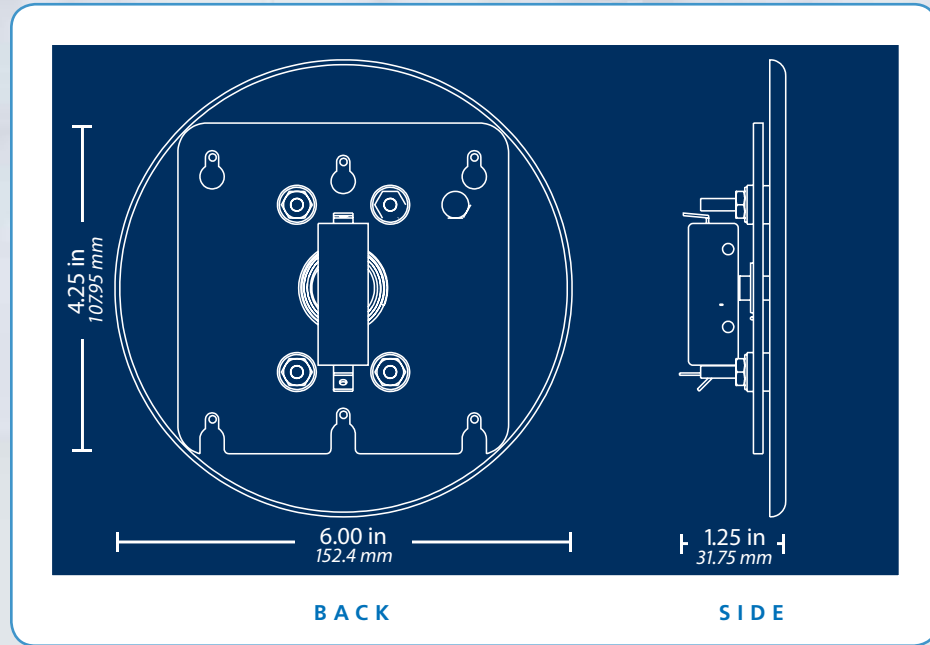

TECHNICAL SPECIFICATIONS

Materials	Faceplate: 16 gauge, 304 2B Stainless Steel
	Backplate: 1/8 inch thick, Aluminum
Cherry Switch	Single-pole, 15 A, COM/NO/NC
Compatible Wireless Frequencies	433, 390 or 300 MHz

Specifications are subject to change without prior notice.

DISCLAIMER This document as well as all other enclosed documents (quotation / specification / other) are provided "as is" without warranties of any kind, either expressed or implied, including but not limited to the implied warranties of merchantability, fitness for a particular purpose, or non-infringement. / Information is supplied upon the condition that the persons receiving it will make their own determination as to its suitability for their purposes prior to use. In no event will BEA be responsible for damages of any nature whatsoever resulting from the use of or reliance upon information from this document or the products to which the information refers. / BEA has the right without liability to change descriptions and specifications at any time. / Prices, shipping and availability are subject to change without prior notice.



WWW.BEASENSORS.COM

6" PUSH PLATE PBR SERIES

79.0074.03 20121101

A HALMA COMPANY

BEA Inc.
RIDC Park West
100 Enterprise Drive
Pittsburgh, PA 15275-1213

PHONE: 1 800.523.2462
FAX: 1 888.523.2462



Member
American Association of
Automatic Door Manufacturers

BEA
OPEN UP NEW HORIZONS