

Reference Dimensions

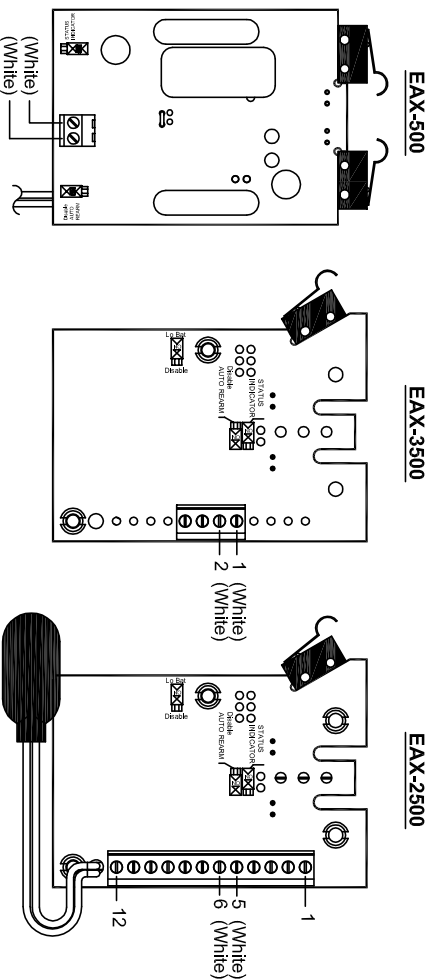

NOTE:
These MS products operate optimally with the recommended air gaps.
See opposite side for installation details.

Figure 1. Wiring Diagram for Detex products

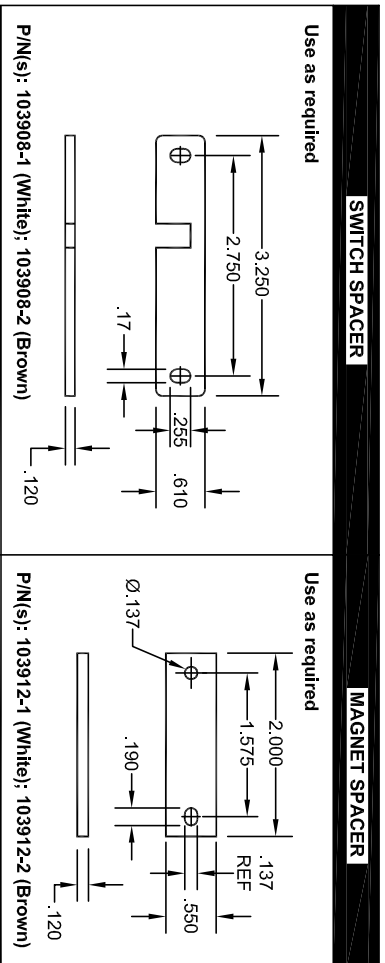
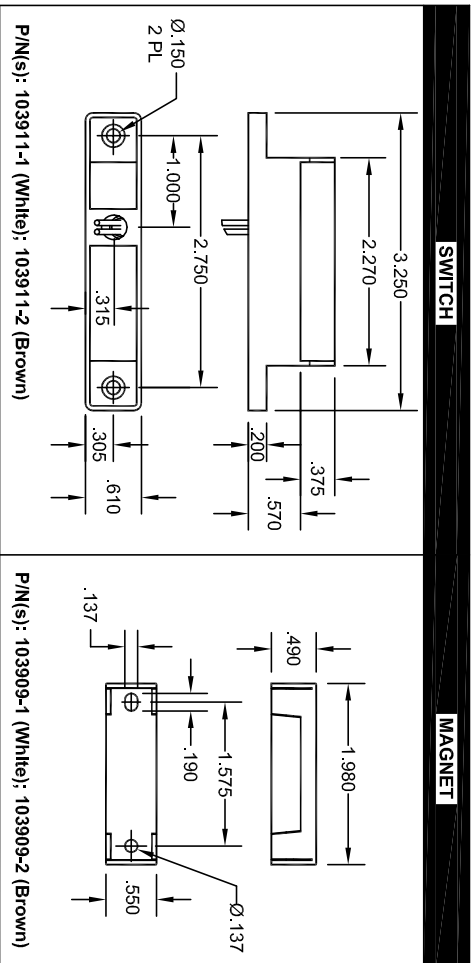
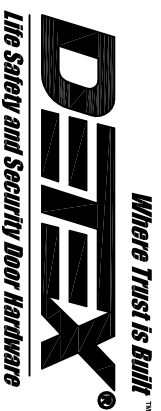

**High Security
Magnetic Switch**
(Uses Magnasphere technology)
MAGNASPHERE®

Hermetically Sealed Switches Contact Material Gold/Gold High Grade Magnets

1 Per
Assembly

- Anti-Tamper Design
- Polarity Selection is Non-Critical
- Mounting Screws Included
- Durable Magnet
- Simple Installation
- Multiple Colors
- Max. Contact Rating
30VDC @ 250mA

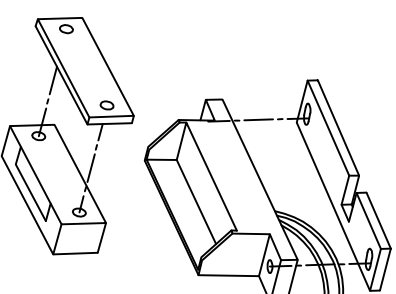

- Model MS-1039S**
White, Magnetic Switch,
Surface Mount,
Wire Leads
- Model MS-1059S**
Brown, Magnetic Switch,
Surface Mount,
Wire Leads

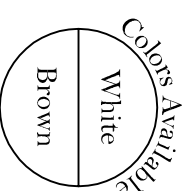

Detex Corporation

302 Detex Drive
New Braunfels, Texas 78130
(800) 729-3839 Fax: (830) 620-6711
www.detex.com
Instruction p/n: 103137, Rev: 6-11-15

TOP OF DOOR INSTALLATION RECOMMENDED

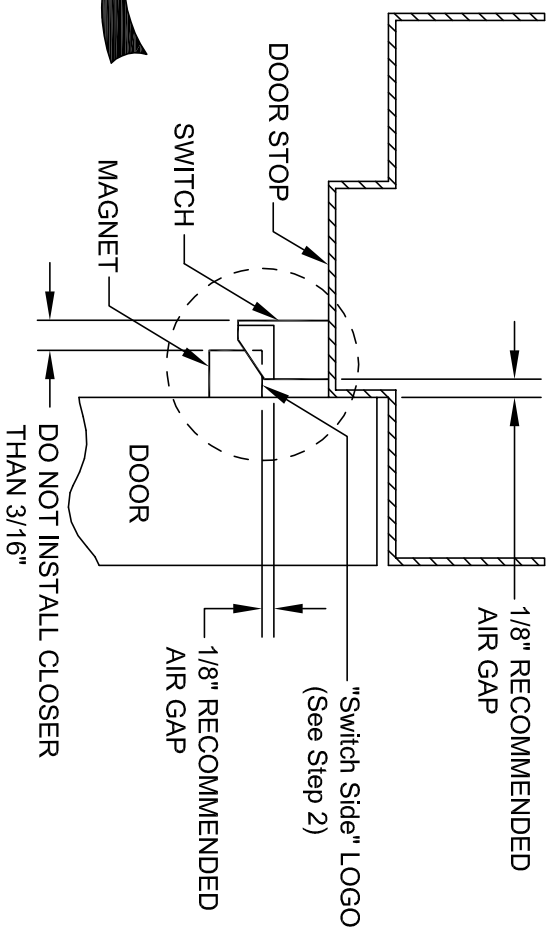
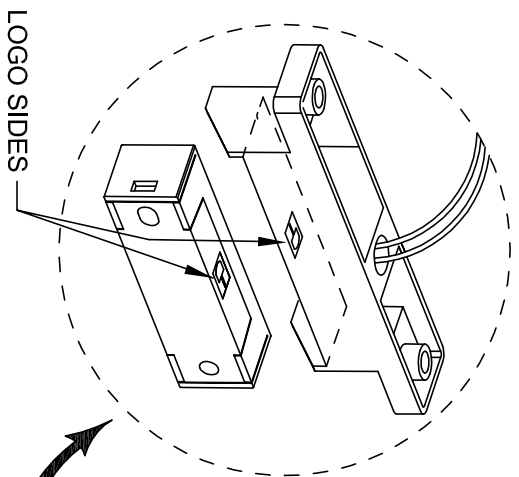

TEMPLATE

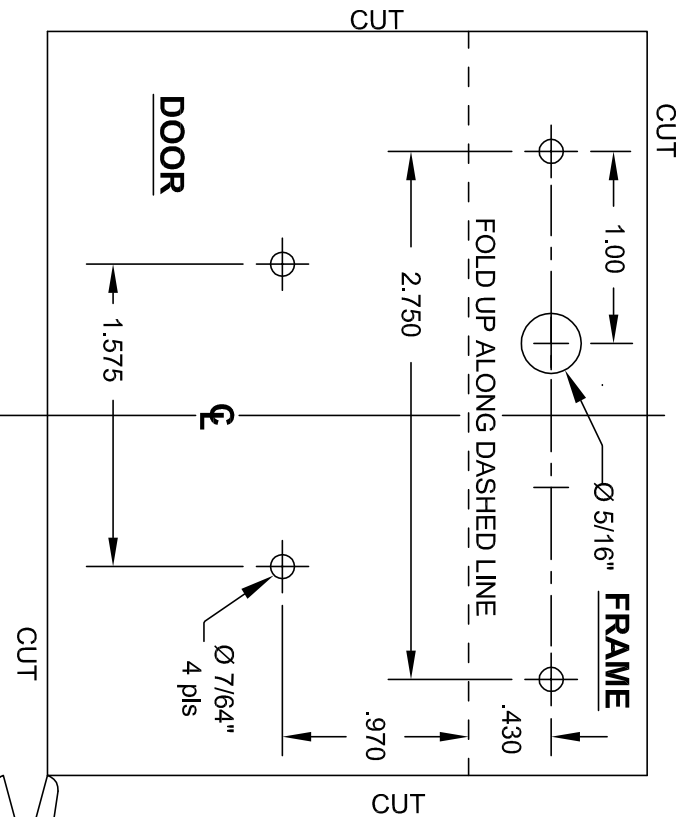

STEP 1: Fold template along dashed line. Place template against door and top of frame so that the centerline is located approximately 6 inches from frame stop. Mark and drill 2 mounting holes in the door and 2 mounting holes and wire routing hole (if required) in the frame as indicated on the template.

STEP 2: Remove magnet cover. Use the 2 provided screws and install magnet on the door. Snap cover back in place.

STEP 3: Install switch using 2 provided screws, route wires as required. Set air gap to 1/8" recommended. Use shims provided for the switch and/or magnet if necessary. Discard shims not used.

STEP 4: Complete wiring and test operation.