



**Corbin
Russwin**

ASSA ABLOY



2020 Price List

Number 34

USA & Canada Prices Effective March 16, 2020



Experience a safer
and more open world

SECTION	PAGE
---------	------

Service Center Business Hours, Holiday Schedule	5
Partner Services in Canada, Business Hours, Holiday Schedule	5
Order Forms	6
Key System Information Request Form	10
Keyed Order Lead Sheet	11
Tools and Rules	14
Terms and Conditions	18
Warranty	22
Finishes, Samples, Templates	24

KEY SYSTEMS

General Information	26
Policy	29
Construction Core	30
Keying, Stamping, Cut Keys	31
Bitting List	32
Key Wizard	33
Key Blanks	34
Access 3 AP Security Cylinders	36
Pyramid Cylinders	42
Conventional Cylinders	48
Interchangeable Core Cylinders	56
Security Cylinders	60
Master Ring Cylinders	66
Service Equipment	69

ACCESS CONTROL

Access 800® AC2	72
ML20800 AC2 Series /AC2 Museo Levers	73
CL33800 AC2 Series / AC2 Museo Levers	80
ED5000 x 9800 AC2 Series / AC2 Museo Levers	84
WM800 Reader/Controller	93
Wiring Diagram Services and Accessories	94

MORTISE LOCKSETS AND TRIM

MicroShield® How to Order	98
ML2000 Series / Museo Levers & Inspire Trim, Roses & Thumbturns, Escutcheons	99
Vineyard™ Collection	114
Vandal Resistant Trim	116
ML20900 Series & ML20600 NAC Series / Museo Levers	117
Cylinder and Keying Options	136
Miscellaneous Options	139

SPECIALTY HARDWARE

MicroShield® How to Order	142
BHSS Trim	143
BLSS Trim	144
HSS Trim	145
HPSK Trim	146
HP3000 Series Tubular Lock with Push/Pull Trim	147

CYLINDRICAL LOCKS

MicroShield® How to Order	150
TL3700 Series: Museo Levers & Inspire Trim, Levers & Roses, Options	152
CL3100 Series Grade 1 Vandal Resistant Cylindrical Lever Locksets	156
CL3300 Series Grade 1 Extra Heavy-Duty Cylindrical Lever Locksets	162
CL3500 Series Grade 1 Heavy-Duty Cylindrical Lever Locksets	168
CL3800 Series Grade 2 Standard-Duty Lever Locksets	174
CK4300 Series Grade 1 Heavy-Duty Cylindrical Knob Locksets	177
CK4400 Series Grade 2 Standard-Duty Cylindrical Knob Locksets	178

PRE-ASSEMBLED UNIT LOCKSETS	PAGE
UT5200 Series	186
AUXILIARY HARDWARE	
PL5000 Series Padlocks	191
DL2200 Series Cylindrical Deadlocks	193
DL3000 Series Cylindrical Deadlocks	196
DL3200 Series Cylindrical Deadlocks	199
DL4100 Series Mortise Deadlocks	202
MULTI-POINT LOCKS	
FE5400S	206
FE6600	221
FE6700	231
MP9800	235
EXIT DEVICES	
MicroShield® Technology	249
ED3000 Crossbar Series	250
ED4000 Narrow Stile Pushpad Series / Museo Levers with 800 Series Escutcheon	263
ED5000 Pushpad Series / Museo Levers with 900 Series Escutcheon	277
ED7000 Narrow Stile Crossbar Series	302
ED8000 Pushpad Series	313
DOOR CLOSERS	
DC3000 Series	324
DC5000 Series (Cam Action Door Closer)	326
DC6000 Series	328
DC8000 Series	332
DC46900 Series (Safeguard™)	337
DC62900 Series	338
PARTS	
Key Systems	
Plugs and Shells	340
Cylinder Parts	341 - 342
Standard Diameter Cylinder Collars	343
Master Ring Cylinder Collars	344
Tools	344
Mortise Locksets and Trim	
ML2000 Series – Mortise Locks	345 - 347
ML2000 Series – Mortise Trim	348 - 356
Vandal Resistant Cylindrical Lever Locksets	
CL3100 Series	357 - 359
Extra Heavy-Duty Cylindrical Lever Locksets	
CL3300 Series	360 - 362
Heavy-Duty Cylindrical Lever Locksets	
CL3500 Series	363 - 364
Grade 2 Key-In-Lever	
CL3700 Series	364
CL3800 Series	365 - 366
Heavy-Duty Cylindrical Knob Locksets	
CK4300 Series	367
Standard-Duty Cylindrical Knob Locksets	
CK4400 Series	368

Continued on next page.

PARTS	PAGE
Pre-Assembled Unit Locksets	
UT5200 Series	369 - 370
Padlocks, Deadlocks and Push-Pull Latches	
Padlocks	370
DL3000 Series Deadlocks	370
ED4000 and ED5000 Series	
Device Parts	371 - 373
Trim Parts	373 - 375
Crossbar Exit Devices and Trims	
ED7000 Series	376 - 380
Pushpad Exit Devices and Trims	
ED8000 Series	381 - 382
Door Closers	
DC3000 Series	383
DC5000 Series	384
DC8000 Series	385
Electronic Hardware Parts	
DC46900 Series	386
DC62900 Series	386
Access 800® AC2 Series	386
Parts Index	387

Service Center Business Hours

ASSA ABLOY Door Security Solutions®

Customer Service – Monroe 8:00 a.m. – 4:30 p.m. (Eastern)

1902 Airport Road

Monroe, NC 28110

Telephone Number: (800) 438-1951

Fax Number: (800) 338-0965

Technical Product Support 8:00 a.m. - 4:30 p.m. (Eastern)

225 Episcopal Road

Berlin, CT 06037

Telephone Number: (888) 607-5703

Electrified Technical Product Support 8:00 a.m. - 4:30 p.m. (Eastern)

Telephone Number: (800) 810-WIRE (9473)

Fax Number: (203) 603-5981

Holiday Schedule* These following entities will be CLOSED on these dates:

ASSA ABLOY Door Security Solutions® Customer Service – Monroe

- January 1, 2020
- February 17, 2020
- April 10, 2020
- May 25, 2020
- July 3, 2020
- September 7, 2020
- November 26-27, 2020
- December 24-25, 2020
- December 31, 2020

* Dates subject to change.

Technical Product Support

- January 1, 2020
- February 17, 2020
- April 10, 2020
- May 25, 2020
- July 3, 2020
- September 7, 2020
- November 26-27, 2020
- December 24-25, 2020
- December 31, 2020

Electrified Technical Product Support- New Haven CT

- January 1, 2020
- January 20, 2020
- February 17, 2020
- April 10, 2020
- May 25, 2020
- July 3, 2020
- September 7, 2020
- November 26-27, 2020
- December 24-25, 2020
- December 31, 2020

Partner Services In Canada

Business Hours: Customer Service Hours: 8:00 AM to 4:30 PM Eastern Standard Time.

Toll Free Telephone Number: 1-800-461-3007

Order Fax Number: 1-800.461.8989.

Order email: orders.dss.ca@assaabloy.ca

RGA email: rga.dss.ca@assaabloy.com

Technical Support email: techsupport.dss.ca@assaabloy.com

Customer Support: Ontario email: customerservice.dss.caontario@assaabloy.com

Customer Support: East email: customerservice.dss.caeast@assaabloy.com

Customer Support: West email: customerservicedss.cawest@assaabloy.com

2020 Canadian Calendar:

- Jan 01 New Year's Day
- Feb 17 Family Day
- Apr 10 Good Friday
- May 18 Victoria Day
- Jul 01 Canada Day
- Aug 03 Civic Holiday
- Sep 07 Labour Day
- Oct 12 Thanksgiving Day
- Dec 25 Christmas Day
- Dec 26 Boxing Day

For Terms & Conditions and Warranty information pertaining to product sales in Canada, please visit www.assaabloy.ca/terms.

Note that some products may not be available in Canada as well as some of the programs offered in this price book may differ between the USA and Canada. Please contact your sales representative for more information.



CUSTOMER ACCOUNT #	PLEASE CHECK	DATE REQUESTED		SOLD TO ADDRESS
	<input type="checkbox"/> PART SHIP	<input type="checkbox"/> SHIP COMPLETE		

CUSTOMER P.O. #	P.O. DATE
CONTACT PERSON	SHIP TO ADDRESS
PHONE #	
FAX #	

SHIP VIA	MARKS
	<small>If markings are required, purchase order will be entered to the factory. See Stock Condensed Order Form to include appropriate information.</small>
BUYING PROGRAM	<input type="checkbox"/>
OR	
CPQ NUMBER	<input type="checkbox"/>

QTY <i>Required</i>	PART # <i>Required</i>	CYLINDER <i>(2000X033)</i>	KEY BLANKS <i>(6 pin-10)</i>	SERIES & FUNCTION <i>Required</i>	TRIM, DR WIDTH & HEIGHT	HAND <i>R, L, RR, LR</i>	FINISH <i>Required</i>	KEYWAY/SECTION	QUICK CODE <i>M52, M54, M55, M94, KR Electrified Locks (Requires Voltage)</i>



ASSA ABLOY

Stock - Condensed Order Form

USA & Canada Prices Effective March 16, 2020

Sheet _____ of _____
 This Sheet Only

Customer Name				Purchase Order No.	
Qty.	Series and Function	Trim	Keyway	Finish	Quick Code Options
Special Notes:					

Item	Qty.	Key Symbol	Hand				Door Number (Up to 10 characters)	Heading (Up to 10 characters)
			RH	LH	RHR	LHR		



ASSA ABLOY

**Keyed Order - Condensed Form
(Cylinders Ordered Separately)**

USA & Canada Prices Effective March 16, 2020

Sheet _____ of _____

This Sheet Only

Customer Name				Purchase Order No.		
Qty.	Cylinder	Length	Pins	Keyway	Cam/Tailpiece	Finish
Special Notes:						

Item	Qty.	Key Symbol	Door Number (Up to 10 characters)	Heading (Up to 10 characters)	Keyed Function Used

**Keyed Order - Condensed Form
(Cylinders Ordered With Lockset/Device)**

USA & Canada Prices Effective March 16, 2020

Sheet _____ of _____
 This Sheet Only

Customer Name				Purchase Order No.	
Qty.	Series and Function	Trim	Keyway	Finish	Quick Code Options

Special Notes:

Item	Qty.	Key Symbol	Hand				Door Number (Up to 10 characters)	Heading (Up to 10 characters)
			RH	LH	RHR	LHR		



ASSA ABLOY

Date: _____

KEY SYSTEMS INFORMATION

*Registry Number: _____

*Job Name and Location: _____

*Keyway: _____ Top Master Key Bitting: _____

Any Other Known System Information:

Information Requested:

Requested By: _____

Phone: _____ Fax: _____ Email: _____

Agency/Distributor Name: _____

Key System Administration Response:

Please attach a Letter of Authorization from the end user if requesting bitting information.

***Required Information**

Sheet 1 of _____
Date: _____
Purchase Order No.: _____
Date Required: _____

SOLD TO:

SHIP TO:

1. JOB NAME AND ADDRESS

2. SYSTEM STATUS

New Existing Registry No. _____

Customer Bittings (Please attach and indicate How to Read) Bow to Tip Tip to Bow

Corbin Russwin Factory Order No. _____ Authorized Security Code* _____

* Not required if opt-out has been recorded on SID

3. HIGHEST LEVEL OF SYSTEM

1 - SKD 2 - MK 3 - GM 4 - GGM 5 - GGGM

4. SYSTEM TYPE

Security IC Master Ring Conventional Pyramid** Access 3 - AP** Access 3 - AS** Access 3 - AHS**

Other _____

**Required documentation must accompany each initial Pyramid or Access 3 order to avoid delay.

5. KEYS

Keyway Selection: Stock-L4 Standard Restricted* Patented* Protected

Specific Keyway _____

Number of Pins: 5 6 (Default) 7

* Requires PRIOR Key Systems Approval

Depth System: System 70 (Default) Pre-System 70 Access 3-AP Access 3-AS/AHS

Key Bow Style: _____

Pyramid & Access 3 have dedicated Bows: _____

Key Stamping:

<input type="checkbox"/> VKC0 - No Bitting or Key Set Stamping on Keys	<input type="checkbox"/> Bittings (Standard for Conventional Change Keys)
<input type="checkbox"/> VKC1 - Visual Key Control Keys Only	<input type="checkbox"/> DO NOT DUPLICATE
<input type="checkbox"/> VKC2 - Visual Key Control Keys and Cylinders	<input type="checkbox"/> US PROPERTY DO NOT DUPLICATE
<input type="checkbox"/> VKC3 - Visual Key Control Cylinders Only	<input type="checkbox"/> Special Stamping: _____
<input type="checkbox"/> CKC2 - Concealed Key Control Cylinders and VKC Keys	_____
<input type="checkbox"/> CKC3 - Concealed Key Control Cylinders Only	_____

Keyed Order - Lead Sheet (B)

(Use with Keyed Order - Condensed Form)

USA & Canada Prices Effective March 16, 2020

6. KEY QUANTITY

Master Level	Qty.	Special Function	Qty.
<input type="checkbox"/> GGGM _____	_____	<input type="checkbox"/> Control	_____
<input type="checkbox"/> GGM _____	_____	<input type="checkbox"/> CMK	_____
<input type="checkbox"/> GM _____	_____	<input type="checkbox"/> CMK Control	_____
<input type="checkbox"/> _____	_____	<input type="checkbox"/> Emergency	_____
<input type="checkbox"/> _____	_____	<input type="checkbox"/> SKD Control	_____
<input type="checkbox"/> MK / Group _____	_____	<input type="checkbox"/> SKD CMK	_____
<input type="checkbox"/> _____	_____	<input type="checkbox"/> SKD CMK Control	_____
<input type="checkbox"/> _____	_____	<input type="checkbox"/> Maintenance	_____
<input type="checkbox"/> Other _____	_____	<input type="checkbox"/> Housekeeping	_____
<input type="checkbox"/> _____	_____	<input type="checkbox"/> Mechanical	_____
<input type="checkbox"/> _____	_____	<input type="checkbox"/> Engineering	_____
<input type="checkbox"/> _____	_____	<input type="checkbox"/> Janitorial	_____
<input type="checkbox"/> _____	_____	<input type="checkbox"/> Other	_____
Change Keys*	Qty.		
Per cylinder _____	_____		
Per keyed alike group _____	_____		
Per keyed different cylinder _____	_____		

*Two cut change keys are standard per lockset/cylinder, keyblanks cannot be substituted for cut keys.

7. CROSS KEYING

Key Symbol:	To Be Operated By (OBY):

SOLD TO:

Sheet 2 of _____
Date: _____
Purchase Order No.: _____
Date Required: _____

8. CONSTRUCTION MASTER KEYING*

*This section Does NOT Refer To Temporary Construction Cores
This Order: Yes No Establish for future use only

Ship Construction Keys To: _____

Attention: _____

9. PRICING

Order subject to follow pricing:

- Price List Dated _____
- Special Job Quote _____
- Date Quoted _____
- Quote No. _____

- Discounts Quoted**
- Cylindrical Locks _____
 - Mortise Locks _____
 - Deadlocks _____
 - Cylinders Only _____

- Exit Devices _____
- Door Closers _____
- Electrical Options _____
- Other _____
- Other _____

10. PACKAGING AND MARKING

- Pack change keys with locks (Standard)
 - Pack change keys separately (Security, Pyramid and CMK jobs always)
- Label Boxes: Key symbol Door No. Heading

Ship Change Keys To: _____

Attention: _____

11. SHIPPING INSTRUCTIONS FOR MASTER KEYS

Ship Master Keys To: _____

Attention: _____

12. BITTING LIST

Provide Bitting List for This Order: Yes No
Letter of Authorization: Attached

Mail Bitting List To: _____

Attention: _____

13. CONTACT

Name of individual in your organization who is knowledgeable about this project, should any clarification be necessary. (Please print or type.)

Name _____

Phone _____ Fax _____

This form has been completed by: (please print)

Name: _____

ADDITIONAL INFORMATION (attach)

System Expansion Requirements, Special Remarks, etc.

Ordering Tips

- Please submit **Quick Ship Program Orders** and **Plant Product Orders** on separate order forms.
- Please use **Quick Ship Program Forms** for all **Quick Ship Product Orders** and include **Quick Ship Part Numbers**.
- **Order Forms** are included in the Price Book and at www.corbinrusswin.com.
- We recommend using the **Order Form** included with this Price Book when placing purchase orders for Corbin Russwin products. The **Order Form** is available for copying prior to placing your order.
- Please include **Job Name and Registry Number** for all contract orders.
- Be sure to include **Voltage** on all Electrified Hardware orders.
- A **Letter of Authorization** is required for all Protected and Pyramid Keyways.
- **Keyed Lead Sheets A and B** are *recommended* for contract orders that are keyed to existing Master Key systems.
- Remember to include **Keysets** on all contract orders.
- Be sure to include **Handing** for all unit locks, mortise locks and exit devices.
- If you have a **Quote**, please include it with the purchase order. Orders without this information may be delayed.

Ordering Tip — Administrative Documentation

When submitting purchase orders to ASSA ABLOY Door Security Solutions® Consultants for processing, please remember that certain cylinder types and/or keyways require additional administrative documentation before the order can be entered.

Purchase orders will be held and questioned if the following keyway/cylinder types do not have the proper administrative documentation submitted with each purchase order:

- Protected and Pyramid keyway products
- Security cylinders and keys
- High security cylinders and keys

All of the above product types must be accompanied by additional administrative documents unless they are shipping direct to the end user facility. These administrative documents include, but may not be limited to, the following:

- Letter of Authorization – must be submitted on the end user facility letterhead, dated and signed by an authorized individual from the facility. Letter must be quantity specific for certain product types. ASSA ABLOY Door Security Solutions Consultants does not keep letters of authorization on file.
- Registration Certificate – only required for Pyramid systems.

Ordering Checklist

Before placing your order, check for the following:

- ✓ Purchase Order on company letterhead
- ✓ Purchase Order is legible
- ✓ Purchase Order Number
- ✓ Account Number
- ✓ Ship To Address
- ✓ Contact Person for additional information requirements
- ✓ Pricing Requirements – Buying Program or CPQ (please attach)
- ✓ Quick Ship Order (Quick Ship Order Form or Quick Ship part numbers included)
- ✓ Contract Order (Keyed Lead Sheets attached)
- ✓ Handing (if applicable)
- ✓ Design (if applicable)
- ✓ Backset & Strike (if applicable)
- ✓ Finish (if applicable)

Website

Corbin Russwin’s website at www.corbinrusswin.com is the place to go for all your Corbin Russwin product information needs. Easy-to-navigate menus and intuitive icons allow simple and fast access to the latest on new products, as well as the most up-to-date catalogs, templates and installation instructions.

Another great benefit of the Corbin Russwin website is the ability to become an eBusiness member. Access gives additional information for Corbin Russwin account customers only.

eBusiness

Visit www.corbinrusswin.com to sign up for ASSA ABLOY Door Security Solutions eBusiness access.

ASSA ABLOY Door Security Solutions Consultants provides sales, marketing and support for Corbin Russwin.

To sign up for eBusiness, follow the simple instructions listed below. Register today and start enjoying the many benefits!

eBusiness offers anytime access to:

- Order Status
- Stock Status Check
- Key Systems
- Newsletters
- Contact Webmaster
- Fax Order Acknowledgment
- Extended Literature (Price Books, Order Forms, Keyed Lead Sheets)
- Order Check by P.O.
- Cross Reference Guide
- Key Wizard® Order Forms
- ASSA ABLOY Door Security Solutions Online Store
- Fax Program Sign Up
- Fax Invoice

How to sign up for eBusiness access:

- Step 1: Visit our website at www.corbinrusswin.com
- Step 2: Double-click eBusiness icon (top right corner)
- Step 3: Complete ASSA ABLOY Door Security Solutions eBusiness sign up form



ONLINE ORDER ENTRY

Would you like to reduce the time to get your orders entered to the factory and eliminate errors associated with manual order entry?

Then try our on-line order entry system. Our convenient web-based order forms can help you submit your orders directly to the factory in minutes.

Contact your customer service representative who will be able to issue your user name and password as well as set up appropriate training sessions for you and your staff.

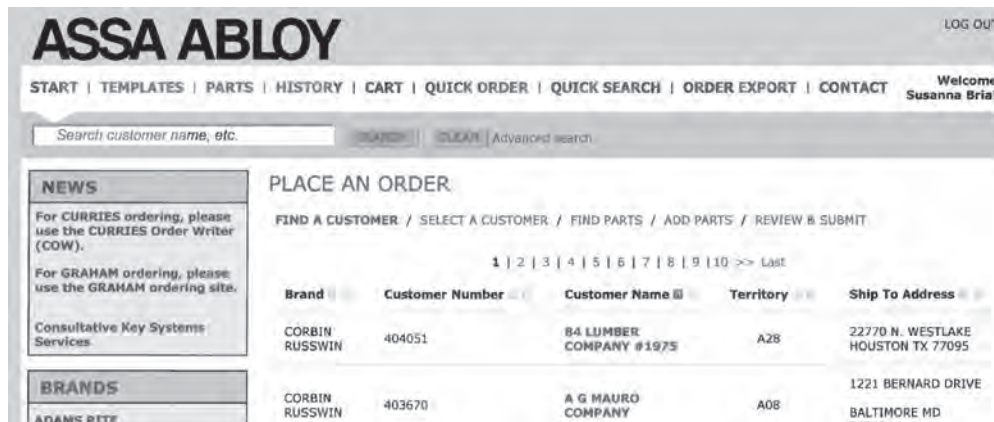

FAX PROGRAM

Would you like to receive your acknowledgments and invoices, invoices and Return good Authorizations quickly and efficiently?

If so, ASSA ABLOY Door Security Solutions offers the Order Acknowledgment and Invoice, invoices and Return good Authorizations Fax Program. Please see the simple steps below to get signed up today!

Requirement: Valid eBusiness User ID and Password. (If you do not have an eBusiness User ID and Password, please refer to eBusiness Sign Up Section included in this Price Book.)

Step 1: Log into eBusiness.

Step 2: Double-click on "Sign Up for ASSA ABLOY Door Security Solutions's Fax Program Now!"

Step 3: Fill in appropriate information and send.

Fax Program Signup

If your distributor would like to receive their CORBIN RUSSWIN, NORTON, RIXSON and YALE order acknowledgements, invoices, and return goods authorizations by fax, please complete the form below to sign them up today!

Yes - Fax Invoices to Fax #: _____

Yes - Fax Order Acknowledgements to Fax #: _____

Yes - Fax Return Goods Authorizations to Fax #: _____

Enter the distributor's Account Number in the input box below and click [Add] to add it to your Account Number list. Repeat for each distributor Account Number that you have.

Enter Account Number:

Account Number List:

Terms and Conditions

ACCEPTANCE

Corbin Russwin reserves the right to decline an order, in whole or in part, when the type or quantity of goods or credit worthiness of the Purchaser is not satisfactory to us in our sole and absolute discretion.

Purchase Orders, Quote Requests, Acknowledgements or the like issued by the Purchaser that have contrary standard terms and conditions are not binding on Corbin Russwin, unless such terms and conditions are approved in a separate written agreement by Corbin Russwin's authorized representatives. In the event of an acceptance of Purchaser's Purchase Order by Corbin Russwin, the Purchaser agrees that such acceptance is solely conditioned on Purchaser's acceptance of the terms and conditions set forth in this instrument, regardless of the terms and conditions specified in Purchaser's Purchase Order. The terms and conditions in Purchaser's Purchase Order which conflict with the terms and conditions of this instrument shall be disregarded and are hereby rejected, and this instrument shall constitute the entire agreement between Corbin Russwin and the Purchaser.

In the event that Corbin Russwin does not enforce or require strict performance of any term or condition hereof, or of any other document, instrument or other agreement relating to goods sold, such lack of enforcement or requirement of strict performance will not waive, affect or diminish any right of Corbin Russwin to enforce or require strict performance of such term or condition in the future.

PRICES

All prices are subject to change without notice and are not guaranteed. All shipments will be made at prices in effect at the time of shipment.

Possession of this price list does not constitute an agreement to sell.

We reserve the right to correct clerical, stenographic and other obvious errors at any time.

TERMS

Invoices dated the 1st through the 15th will be due for 2% discount on the *10th of the following month. Invoices dated the 16th through the 31st will be due for 2% discount on the *25th of the following month. *Net immediately thereafter. (Corbin Russwin retains the right to sell or to decline to sell to any Customer for any reason whatsoever when in its judgment is deemed sufficient.)

It is understood that Corbin Russwin may impose and charge a finance charge which is the lesser of one and one-half percent (1-1/2%) per month or the highest rate allowed by law on any amount which becomes past due and delinquent. Additionally the Customer shall be responsible for all collection costs, court costs and reasonable attorney's fees (where allowed by law) in connection with the recovery of any delinquent amount.

FREIGHT

All orders are shipped FOB factory/warehouse, except as expressly provided below. When delivered to the Transportation Company, the Purchaser assumes the risk of loss or damage in transit.

Customer orders with net product value in excess of \$12,000.00 will be shipped prepaid by Corbin Russwin's carrier of choice to a single destination point in the United States.

Customer orders with net product value less than \$12,000.00 will be shipped prepaid by Corbin Russwin's carrier of choice and freight and handling charges will be added to the customer's invoice.

A minimum freight and handling charge of \$15.00 will be charged on orders with net product value of \$400.00 or less. The minimum freight and handling charge will not apply to orders for only Cut (bitted) keys of any type, Master Keys, Master keyed cylinders or padlocks and factory generated bitting lists that do not have any other product types included on the order. Freight on these orders will be charged as the percentage of invoice value.

For orders with net product value greater than \$400.00 and less than \$12,000.00, freight charges will be calculated as a percentage of the net invoice value and will be added to Customer's invoice. The percentage is based on the National U.S. Average On Highway Diesel Fuel Prices as reported by the US Department of Energy in effect at the beginning of each quarter. On the first Monday of each quarter, the new rate will be published on the Corbin Russwin and Door Security Solutions extranet and will go into effect on the 2nd Monday of the quarter. Please refer to the extranet for the rate chart and information on the current freight charge percentage. The percentage in effect at the time of shipment of the order will be charged.

Great Grand Master keys, Grand Master keys, Master keys, Construction Master keys, Control Keys, Lot Day Keys which are shipped separate from customer order for security reasons, on orders with total net product value in excess of \$12,000.00 will be shipped prepaid by Corbin Russwin's carrier of choice. If the total order value is less than \$12,000.00, the shipping charges will be added to Customer's invoice.

If a customer provides their own freight account # for the freight charges, Corbin Russwin will apply a handling fee of \$25.00 to the invoice.

Quick Ship Orders – All 1-Week Quick Ship orders are guaranteed to ship from Corbin Russwin 5 working days after receipt of all information necessary to process order or Corbin Russwin will pay freight costs. If Quick Ship is held for credit reasons Corbin Russwin will not be responsible for freight costs.

Expedited shipping options – If the customer requests an expedited method of shipment such as "Next Day Air" the charges will be prepaid by Corbin Russwin and the full rate for the service, as published by the carrier, will be added to the customer's invoice.

Terms and Conditions continued

Packing – Corbin Russwin will pack, mark and ship the products according to its standard procedures for shipment, unless the parties agree, in writing, that Corbin Russwin will comply with any special instructions provided by the customer. Special instructions must be submitted, in writing, at time of order placement. Compliance with special instructions may result in an increased price.

MINIMUM ORDER

Minimum order value for complete product is \$250.00 net product value. The minimum order value for parts orders is \$100.00 net product value. In the event that the net product value does not meet the required net minimum, Corbin Russwin may, at its sole discretion (a) apply a minimum order charge, (b) reject the order or (c) waive the minimum requirement provided that the waiver of the requirement for one order shall not constitute a waiver of the requirement for any future orders.

The following products are exempt from this policy: Cut (bitted) Keys of any type, Master Keyed Cylinders, Master Keyed Padlocks and Factory Generated Bitting Lists.

QUOTATIONS

If Corbin Russwin elects to offer a quote, such quote will be valid until the expiration date on that quote. Complete shipment of the order must be accepted by Purchaser within standard manufacturing lead times. The quote number must be referenced on the order. Any invoiced order that has the incorrect discount applied to it and did not have the quote number written on the order will have a service fee of \$100.00 net DEDUCTED from any sales credit issued for the difference in discount. The quote is null and void if the Purchase Order does not include ALL product lines listed on the quote or if the quantities for any item covered by the quote deviate by 10% or more. With the issuance and acceptance of a quote for the purchase of products, the Purchaser agrees that products so purchased will not be resold or transferred to any Distributor not authorized by Corbin Russwin to sell its products. This would be inclusive of branches of the quoted Distributor. Failure to abide by this restriction may result in the Distributor's ineligibility for Quotations, or other actions in Corbin Russwin's discretion. Corbin Russwin and its sales representatives reserve the right, in their sole discretion and for any reason, to refuse a Distributor's request to quote a price other than Corbin Russwin's standard list price and regardless of whether Corbin Russwin or its sales representatives have previously quoted discounted prices to the Distributor on some or all of its orders.

NON-CATALOGED PRODUCTS

Products not cataloged or listed in this price book will be considered as special products, and will not be manufactured without prior written approval from Corbin Russwin. A minimum special handling charge of \$50.00 will be added for non-cataloged product. Any additional labor or material required will be charged accordingly. Special products require special handling, and therefore standard lead times may not apply. Please consult with your Sales Representative for further details.

CHANGES/CANCELLATION OF ORDERS

Changes or cancellations to an order will result in a charge of costs for material and labor expenses that have been incurred prior to notification from Customer. If products have already been made and/or are located in the shipping room, the 45% change/cancellation fee will apply. Handling charges are billed on Customer's original order. All Non-Cataloged Goods and Corbin Russwin Quick Ship Orders may not be changed or cancelled.

ADD-ON ORDERS TO QUOTE

Any new order requesting special pricing to match an existing quote number, which has already been ordered, will be accepted up to sixty (60) days after the acknowledgment of the original order. All add-on orders must reference the original factory order number, and the corresponding quote number to receive the quoted pricing discount. Add-on orders for stock will not be accepted.

PACKAGING

Many items are defined as to Case Lot Packaging or Minimum Order. The Case Lot policy does not apply to hardware to be used on a specific hardware project.

DELIVERY

Orders will be acknowledged and given a scheduled delivery date based on estimated manufacturing lead times. Complete information is required to process all orders. Orders with insufficient information for processing (i.e. keying information, door sizes, handing, etc.) may be subject to extended lead times which are relative to the time required in obtaining the necessary information for order processing. Manufacturing lead time will begin once all information is received to process an order. Corbin Russwin will use reasonable efforts to deliver products as estimated, but makes no guarantees as to delivery dates. Corbin Russwin will not be liable for back charges incurred based on availability of product or as a result of delays in delivery caused by insufficient information required to process an order. Corbin Russwin will not be held responsible for delays in delivery caused by strikes, fires, floods or any other causes beyond our control, including the delivery of material to us. Under no circumstances shall Corbin Russwin be liable or accountable for consequential damages due to failure of delivery.

CLAIMS

In the event of Company or Customer error, claims for shortages, pricing errors and/or incorrectly filled orders must be submitted in writing to Customer Service within thirty (30) days from receipt of material. Any claims for shortages or damage by the Carrier must be made by the Customer directly to the Carrier.

Terms and Conditions continued**INVOICE DEDUCTION**

A Corbin Russwin Sales Representative or Customer Service Representative must be notified of any disputed invoices within sixty (60) days from the date of invoice. Deductions should only be taken for the disputed amount and the balance of the invoice is due and payable within standard payment terms.

RETURNED GOODS

It is the policy of Corbin Russwin to not accept returns of any materials that are correctly furnished as per the Distributor's Purchase Order. Return of product due to customer order error or accommodation must be pre-arranged with Corbin Russwin and approved in writing by Sales Management.

All products returned as "Goodwill" must meet the following criteria to be considered a return:

- Be in original, unmarked and undamaged cartons.
- Be valued in excess of \$250.00 net.
- Shipped and invoiced within the previous one hundred twenty (120) days.
- Custom, non-cataloged goods, master-keyed or Corbin Russwin Quick Ship product is not returnable.

A MINIMUM reprocessing fee of 45% will be charged. Upon receipt and verification by Corbin Russwin that the returned merchandise meets the foregoing conditions, a credit will be issued for the original invoice amount less the MINIMUM 45% reprocessing fee.

Defective goods and "Goodwill" products that meet the foregoing criteria may be returned by fulfilling the following conditions:

- Send an RGA request in writing to the Corbin Russwin Sales Representative serving the Purchaser's area.
- Ensure the RGA labels that are sent to Purchaser by Corbin Russwin are visible on return goods shipment.
- Ensure that the RGA number appears on the return shipment label and is legible.
- Return the authorized merchandise within sixty (60) days from the date of RGA issuance date.
- Return shipments must be freight prepaid to the location specified on the RGA.
- Corbin Russwin is not liable for damages to product during shipping.

No credit may be taken or issued prior to RGA approval and receipt of product.

All defective goods within the terms of our limited warranty may be returned for credit or replacement.

RETURNED GOODS – ELECTROMECHANICAL

All defective replacement requests for electromechanical products/components must be authorized by contacting the Electromechanical Applications Team at 1-800-810-WIRE to obtain a case number. In order to receive credit for the replacement of an electromechanical product the following criteria needs to be met:

- Defective product return must be under warranty
- Defective product/component return must arrive at factory within 60 days of the Returned Goods Authorization issuance
- Returned product must be found defective or nonfunctional upon test at factory
- Returned product must not have been damaged during installation process

TAXES

Prices do not include any present or future Federal, State, or Local property, license, privilege, sales, use, excise, gross receipts or other like taxes or assessments, which may result from transactions or any services performed in connection herewith.

GOVERNING LAW

The rights and obligations of the parties shall be governed by the laws of the State of North Carolina, excluding any conflicts of law provisions. The United Nations Convention on Contracts for the International Sale of Goods shall not apply to this Agreement.

LIMITED WARRANTY

The Terms and Conditions outlined above are subject to Corbin Russwin's Limited Warranty, which is included in this Price List and incorporated herein by reference.

PRODUCT MODIFICATIONS

Corbin Russwin products are not designed or intended for aftermarket modification. The warranty on Corbin Russwin products becomes void if the product is modified in any way, regardless of whether the modification causes or contributes to any alleged defect. Warranty voiding modifications include, but are not limited to, third-party electrification of non-electric products and/or the installation of non-approved or non-Corbin Russwin components.

If a Corbin Russwin product is modified it no longer meets industry certification and quality control standards applicable to the original product and is no longer a genuine Corbin Russwin product. A modified product may not be sold as a Corbin Russwin product and the Corbin Russwin and Design® trademark or certification marks based on the original Corbin Russwin product, such as U.L. or ANSI/BHMA marks, may not appear anywhere on the modified product or on any packaging, literature, or instructions sold with the modified product.

All original Corbin Russwin packaging and literature carries the Corbin Russwin and Design® trademark and must be destroyed if the original Corbin Russwin product is modified. Portions of the product that carry the Corbin Russwin and Design® trademark or certification mark must be discarded and/or replaced by the party making the modification. U.L. and other certification testing and marking are also the responsibility of the party making modification. The use of the Corbin Russwin and Design® trademark on modified products constitutes trademark infringement.

Terms and Conditions continued**FIRE RATED OPENINGS**

Any retrofit or other field modification to a fire rated opening can potentially impact the fire rating of the opening, and Corbin Russwin, Inc. makes no representations or warranties concerning what such impact may be in any specific situation. When retrofitting any portion of an existing fire-rated opening, or specifying and installing a new fire-rated opening, please consult with a code specialist or local code official (Authority Having Jurisdiction) to ensure compliance with all applicable codes and ratings.

The following policy ("Policy") of ASSA ABLOY Americas ("ASSA ABLOY"), and all of its affiliated group companies (collectively, the "Group Companies"), applies to the use of certain intellectual property of all such Group Companies, including all trademarks, names, logos, product images, and related information (the "ASSA ABLOY Marks"). ASSA ABLOY Marks are proprietary and critical to the success of ASSA ABLOY and the Group Companies, and may only be used in strict compliance with this Policy.

This Policy covers any person or entity reselling any product of any Group Company with the consent of such Group Company (each, an "Approved Reseller"). Each Approved Reseller has a non-exclusive right to use certain of the ASSA ABLOY Marks relating to any of the Group Companies for which it is an Approved Reseller, subject to the following conditions:

- (1) Approved Reseller's use of ASSA ABLOY Marks must be truthful, fair, and not misleading;
- (2) Approved Reseller's advertising must clearly indicate that it is advertising of the Approved Reseller, and is not advertising of ASSA ABLOY;
- (3) Approved Reseller may not use any ASSA ABLOY Marks as part of or in connection with a domain name;
- (4) Approved Reseller's advertising must not imply or suggest an association between the Approved Reseller and ASSA ABLOY other than that of buyer and seller;
- (5) Approved Reseller's use of ASSA ABLOY Marks must be a positive representation of ASSA ABLOY, the Group Companies, and their products;
- (6) Approved Reseller's trade name must be more predominant on Approved Reseller's advertising than the ASSA ABLOY Marks;
- (7) Approved Reseller's use of ASSA ABLOY Marks must include the trademark symbol ® or ™, as appropriate, along with the following trademark legend printed in legible text on the Web page or document containing ASSA ABLOY Marks: "[describe ASSA ABLOY Marks] are trademarks or registered trademarks of ASSA ABLOY, Inc. or one of its affiliates in the United States and other countries.";
- (8) Approved Reseller must not make modifications of any ASSA ABLOY Marks; and
- (9) Approved Reseller may use only ASSA ABLOY Marks associated with the Group Companies for which it is an Approved Reseller (e.g., an Approved Reseller that sells Group Company X products but not Group Company Y products may use Group Company X trademarks in connection with its sale of Group Company X products, but may not use Group Company Y trademarks).

ASSA ABLOY reserves the right to review Approved Reseller's usage of ASSA ABLOY Marks at any time and may:

- (a) require changes to the use of ASSA ABLOY Marks at any time in its sole discretion, which changes must be implemented within 30 days of written notice to Approved Reseller;
- (b) condition the use of ASSA ABLOY Marks on ASSA ABLOY's prior approval of such use, which approval may be withheld in its sole discretion;
- (c) revoke permission to use ASSA ABLOY Marks at any time for any or no reason upon 30 days prior written notice to Approved Reseller; and
- (d) revoke permission to use ASSA ABLOY Marks immediately upon notice to Approved Reseller in the event Approved Reseller is in violation of this Policy, or of any other agreement with ASSA ABLOY or any Group Company.

Approved Reseller's right to use ASSA ABLOY Marks in no way conveys to Approved Reseller any proprietary or economic interest in any ASSA ABLOY Marks.

Use of ASSA ABLOY Marks in violation of this Policy may result in severe civil and criminal liabilities. ASSA ABLOY will vigorously enforce this Policy by seeking all appropriate legal remedies, including, but not limited to, pecuniary damages and injunctive relief.

If there are any questions on this policy, please contact Linda Dean at ldean@assaabloyusa.com or 203-498-5596.

TECHNICAL INFORMATION AND ADVICE

(a) All designs, data, and specifications provided by Company are proprietary and will not be disclosed or reused by Customer without the prior written consent of Company; (b) Company assumes no obligation or liability for any advice given by Company, the results obtained, or damages incurred, and all such advice is given and accepted at Customer's risk.

Limited Warranty

Corbin Russwin, Inc. (Company) warrants that its products sold under the Corbin Russwin and Design® trade name in the United States of America are free from defects in workmanship and materials under normal use and service. This warranty does not cover defects or damage arising from improper installation, lack of or improper maintenance, improper storage, shipping and handling, corrosion, erosion, ordinary wear and tear, misuse, abuse, accident, unauthorized service, or use with unauthorized non-Corbin Russwin products or parts. This warranty is void if any modification is made to the warranty product, regardless of whether the modification causes or contributes to the alleged defect. All modifications are made at the risk of the party making the modification.

The only liability of the Company in tort or contract whether under this warranty or otherwise shall be limited to the repair or replacement of any product or component part which shall prove defective as covered by this warranty, within the stated time frame listed below, after delivery to the original purchaser.

Access 3 Cylinders	1 year
Pyramid Cylinders	5 years
CL3100 Series Cylindrical Locksets	10 years
CL3300 Series Cylindrical Locksets	7 years
CL3500 Series Cylindrical Locksets	7 years
CL3800 Series Cylindrical Locksets	5 years
CK4300 Series Cylindrical Locksets	3 years
ML2000 Series Mortise Locksets	10 years
Electrified Locksets	2 years
ED3000, ED7000, ED8000 Series Exit Devices & Trim	1 year
ED4000, ED5000 Series Exit Devices & 900 Series Trim	5 years
All Other Exit Device Trim	1 year
Motorized Electric Latch Retraction (MELR)	5 years
Electrified Exit Devices	2 years
FE5400S	7 years
FE6600	7 years
FE6700	7 years
Access 800® CL33800 x TCAC2 Cylindrical	7 years (mechanical), 2 years (electrical)
Access 800® ML20800 x TCAC2 Mortise Locks	10 years (mechanical), 2 years (electrical)
Access 800® ED5000 x 9800 x TCAC2 Exit Devices	5 years (mechanical), 2 years (electrical)
DC3000 Series Closers	15 years
DC5000 Series Closers	10 years
DC6000 Series Closers	25 years
DC8000 Series Closers	25 years
All Other Corbin Russwin Products	1 year
MicroShield® Finish	1 year

Finishes:

Corbin Russwin finishes are covered by a limited warranty period of one year after invoice date.

Warranty Requirements for Cylinders Factory or Field Combined:

Cylinders are lubricated at the factory with a petroleum based lubricant (Medeco KeyLube). Cylinders should be lubricated periodically depending upon environmental conditions. Petroleum based lubricant is recommended. Never mix petroleum based lubricants with dry lubricants. Corbin Russwin cylinder and/or core warranty will be voided if used in non-Corbin Russwin locking devices.

Warranty Requirements for Cylinders Field Combined:

1. Keys shall be cut to the Corbin Russwin key biting specifications required for the particular keyway and depth system.
2. All pin lengths shall be selected according to prevailing factory standards.
3. Original Corbin Russwin cylinders and cylinder components, including pin tumblers and key blanks, shall be used. We reserve the right to void the warranty if we deem that a malfunction is a result of non-original components which do not conform to Corbin Russwin standards.

Keying Systems:

All bittings shall be originated or authorized by the Corbin Russwin Key Systems Department to be compatible with one another in a specific type of cylinder (Pyramid, conventional, security, master ring, interchangeable core) and within a particular keying system.

All components of electromagnetic products are covered by a limited warranty period of one year after invoice date thereof of the original purchaser from us. Product repair or replacement, or associated charges, will not be accepted under this warranty unless prior authorization from Corbin Russwin has been given. Upon receipt of products returned for repair or replacement, we will determine whether products qualify for repair or replacement under this warranty. If they do not, we will obtain authorization prior to proceeding.

We have no liability to pay any costs of repair performed by anyone other than qualified personnel authorized by Corbin Russwin prior to the work being done.

Terms and Conditions continued

The Company will not pay for the cost of repair performed other than in accordance with this warranty. Written notice of a product or component part believed to be defective as covered by this warranty should be sent to Corbin Russwin, Inc. 225 Episcopal Road, Berlin, CT 06037, and should include your name and address, an identification of the product or component part and a brief description of the defect. Upon receipt of such notice, the Company will inform you where to ship such product or component part, shipping charges prepaid, for examination and, in the event such examination reveals defect covered by this warranty, the product will be repaired or replaced. The Company reserves the right to replace discontinued product with an equivalent product as deemed by the Company.

THIS WARRANTY IS IN LIEU OF ALL OTHER EXPRESS WARRANTIES. TO THE EXTENT PERMITTED BY LAW, ALL IMPLIED WARRANTIES ARE LIMITED TO THE DURATION OF THIS WARRANTY. CORBIN RUSSWIN, INC. SHALL NOT BE LIABLE FOR ANY INCIDENTAL OR CONSEQUENTIAL DAMAGES. NO AGENT, SALES REPRESENTATIVE OR DEALER HAS THE AUTHORITY TO INCREASE OR ALTER THE OBLIGATIONS OF THIS WARRANTY. SOME STATES DO NOT ALLOW LIMITATIONS ON HOW LONG AN IMPLIED WARRANTY LASTS OR THE EXCLUSION OR LIMITATION OF INCIDENTAL OR CONSEQUENTIAL DAMAGES, SO THE ABOVE LIMITATION OR EXCLUSIONS MAY NOT APPLY TO YOU. THIS WARRANTY GIVES YOU SPECIFIC LEGAL RIGHTS, AND YOU MAY ALSO HAVE OTHER RIGHTS WHICH VARY FROM STATE TO STATE.

Finishes

ANSI/BHMA Designation	Finish/Description
600	Primed for Painting (USP)
605	Bright Brass (US3)
606	Satin Brass (US4)
611	Bright Bronze (US9)
612	Satin Bronze (US10)
613	Dark Oxidized Satin Bronze, Oil Rubbed (US10B)
613E	Dark Oxidized Satin Bronze - Equivalent
613L	Dark Oxidized Satin Bronze, Clear Coated
618	Bright Nickel Plated (US14)
619	Satin Nickel Plated (US15)
622	Flat Black Coated (US19)
625	Bright Chromium Plated (US26)
626	Satin Chromium Plated (US26D)
628	Satin Aluminum, Clear Anodized (808 Mullion)
629*	Bright Stainless Steel (US32)
630*	Satin Stainless Steel (US32D)
689	Silver Aluminum Painted (SBL)
690	Dark Bronze Painted (LBL)
691	Light Bronze Painted (DBL)
693	Black Painted (FBL)
695	Dark Bronze Painted or Anodized (808 Mullion)
696	Satin Brass Painted (GBL)
722	Black oxidized bronze, oil rubbed
BSP	Black Suede Powder Coat
WSP	White Suede Powder Coat

*629 and 630 finish options are Not available for the following Muséo levers: 101, 104, 105,111, 112, 113, 114, 115, 116, 117, 119, 121, 122, 126, 127,130, 131, 132

Samples

Display Mounts (Base Hardware not included). Price covers mount only.

For Product Series	Specify	Price
CL3100, CK4400	SM-CL-NTB	\$178.00
CL3300, CL3500, CL3800	SM-CL-TB	\$178.00
ML2000 x Sectional Trim (Lever, Knob, BLSS, HSS, HPSK)	SM-ML-L	\$166.00
ML2000 x BHSS trim	SM-ML-WAVE-CYL x TP	\$260.00
ML2000 x Roseless	SM-ML-RL	\$178.00
UT5200	SM-UT	\$178.00
HP3000	SM-CL-HP3000	\$217.00
Access 800® CL33800	SM-CL-A800	\$205.00
Access 800® ML20800	SM-ML-A800	\$286.00
Access 800® ED5000 x 9800	SM-ED-A800	\$310.00

Pyramid Sample Display Case

Specify	Price
PS-20-DC	\$310.00

Finish folder with cylinder scalps.

Specify	Price
FP	\$160.00

Corbin Russwin Templates

Templates of Corbin Russwin products that are most commonly used are available through our website <http://www.corbinrusswin.com/en/site/corbin-russwin/Library/Product-Templates/>

General Information:

Standard Features: Keying, Keys, Pins	26
Keyway Availability	27
General Information	28
Policy	29
Construction Core Program	30
Keying, Stamping, Cut Keys	31
Bitting List	32
Key Wizard	33

Key Blanks:

Stamping, Standard, Pyramid, Access 3	34
Security Bow, Large Bow, Emergency Blanks, Emergency Master Key	35

Access 3 AP Security Cylinders

AP Fixed Core (Mortise/Rim), AP LFIC (Mortise/Rim)	36
AP LFIC, Fixed Core Component Cylinder, Deadlock Cylinder	37
AS Fixed Core (Mortise/Rim), AS LFIC (Mortise/Rim)	38
AS LFIC Core, AS Fixed Core Component Cylinder, AS Fixed Core Deadlock Cylinder	39
AHS Fixed Core (Mortise/Rim), AHS LFIC (Mortise/Rim)	40
AHS LFIC Core, AHS Fixed Core, Deadlock Cylinder, UL LFIC 6-Pin Housing (Mortise/Rim)	41

Pyramid Cylinders:

Fixed Core (Mortise/Rim)	42
Key-In-Lever/Knob High Security UL437 Listed	43
Interchangeable Core (Mortise/Rim)	44
Fixed Core (Mortise/Rim)	45
Key-In-Lever/Knob	46
Interchangeable Core (Mortise/Rim)	47

Conventional Cylinders:

Standard Mortise	48
Flexible Head Mortise, Concealed Shell Mortise	49
Special Function Mortise, Hotel Function Mortise	50
Non-Keyed Mortise, Thumbturn, Dummy, Rim Thumbturn Cylinders	51
Rim (.552 diameter Plug)	52
Key-In-Lever/Knob (.509 Plug), DL2200, DL3200 Series Cylindrical Deadlock	53
Key-In-Lever/Knob UT5200, CK4200, CK4400, G10, PL5000	54
Key-In-Lever/Knob (.552 dia Plug), Adams Rite 4025 Pull	55

Interchangeable Core Cylinders:

IC Mortise, Hotel Function IC Mortise	56
IC Rim, Core Only	57
LFIC Mortise Housing Only, LFIC Rim Housing Only	58
SFIC Mortise Housing Only, SFIC Rim Housing Only	59

Security Cylinders:

Standard Security Mortise	60
Special Function Security Mortise, Hotel	61
Security Rim	62
Security Key-In-Lever/Knob (.552 Plug)	63
Security Interchangeable Cylinders: IC Mortise, Hotel Function	64
Security Interchangeable Cylinders: IC Rim, Security Core	65

Master Ring Cylinders:

Standard Master Ring Cylinder	66
Flexible Head Master Ring Mortise	67
Master Ring Rim, CK4200 & UT5200 Series, Special Applications	68
Service Equipment	69
Blank Page	70

**Standard Features
Keying**

0-bitted except high security; random keying option offered at no charge

Keys

Two nickel silver keys

Pins

5-pin for 252, 752, 852 and A Class; all others furnished 6-pin

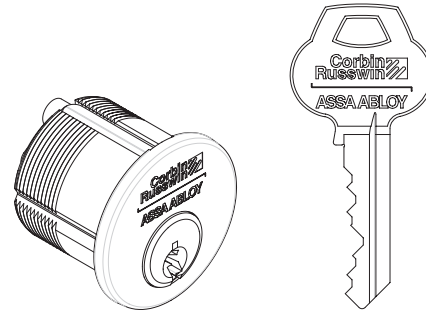

Ordering Examples

Stock Order - Conventional Cylinder

Quantity	Cylinder	Finish
25	CR1000	626

Contract/Detailed Order - Conventional Cylinder

Quantity	Keyset	Cylinder	Finish	Option
25	AA1	CR1000-138-A02-7	626	CKC2

Stock Order - IC Cylinder

Quantity	Cylinder	Finish
20	CR1080	626

Contract/Detailed Order - IC Cylinder

Quantity	Keyset	Cylinder	Finish	Misc.Option
4	AF3	CR1080-112-A04-7	606	CKC2

Keyway Availability

Corbin Russwin keyways are separated into categories known as **Key Classes**, based on blade width and bitting dimensions. **Certain key blanks and cylinders are not available for certain key classes**, and notes to that effect appear in the catalog and price book. If you find a keyway exclusion notice and do not know the class of the keyway you need, refer to the list below.

Some keyways listed here are *inactive*. They remain available to support existing systems, but no *new systems* are generated on them.

Keyway	Remarks
26	Discontinued
27 Series	X Class (28 and 29 are inactive)
57 Series	X Class
59 Series	Z Class
60	Z Class
67 Series	X Class (68 and 69 are inactive)
70	Z Class
77 Series	X Class (77 and 78 are inactive)
97 and 99	X Class
252	852 Class (inactive)
752	752 Class (inactive)
852	852 Class (inactive)
981, 982, 983	981 Class (inactive)
A1 thru A24	A Class (inactive)
Access 3	Access 3
AR, BR, BL	X Class
D1 thru D4	DH Class
G	852 Class (inactive)
H1 thru H8	DH Class
L1 thru L4	Z Class (L2 formerly CCL)
N1 thru N28	N Class (inactive)
Pyramid	Pyramid
Protected	DH or Z Class
Restricted	DH or Z Class

Keyway Name Changes

All Multiplex Keyways using letters with numbers are now standardized to have the letter first and number last. Also, keyway designation will no longer include the number of pins. K and Z designations are being replaced by the more common N and A Series, respectively. 960 and 970 Series are replaced by the more common 980 Series. Only the following Russwin® older keyways are affected:

Old Designation	Pins	New Designation
1N thru 28N	6	N1 thru N28
1K thru 28K	5 or 7	N1 thru N28
1A thru 24A	5	A1 thru A24
1Z thru 24Z	6	A1 thru A24
961, 962, 963	6	981, 982, 983
971, 972, 973	7	981, 982, 983

Category	Description	Price
Stock L4	Keyway used for stock orders and limited keying systems.	No Charge
Standard (see list at left)	Keyways in general use for keying systems.	No Charge
Restricted (not published)	Selective keyways for use in new and existing keying systems.	No Charge
Protected	Notice of Acceptance showing facilities name, address and contact information must be submitted to key records before orders can be processed. Key system administration approval required prior to processing of order.	No Charge
Pyramid	One of Corbin Russwin's line of high security cylinders	See Pyramid pages 42-47
Security	Old Emhart®/Security cylinders.	For existing systems only
Access 3	Corbin Russwin's highest level of key control.	See pages 36-41

Key Systems Security Policy

The purpose of this security policy is to enforce our policies Access 3, Pyramid, Security, Protected & Restricted keyway product, including key system information.

No master key system information or security related product is to be given or sold to anyone other than the facility owner through written correspondence. Verification must be submitted (fax copy will be acceptable) to Key Systems Administration. The verification must be on the facility's letterhead and signed by a facility authorized systems administrator. Key Systems Administration does not maintain "Letters of Authorization" on file. Each order must be accompanied by proper authorization. Only after the authorization has been verified will the order be processed for production.

Also includes:

- Bitting information (even one bitting, absolutely no top-level master keys)
- Bitting lists (all formats; i.e., hard copy, disc)
- Key blanks and systems components for Access 3, Pyramid, protected and security cylinder systems.

Please note:

- No orders are to be processed through Key Systems Administration without proper authorization.
- Only orders with appropriate authorization attached will be given priority.
- Requests for systems information without proper authorization from the owner will be denied.
- Requests for information regarding the purchase of any systems support products as listed above will be referred to the local authorized sales agency.
- Refer to the current price lists for additional policies and procedures as they relate to this security policy.

Remember:

The purpose for the establishment of any security system is to provide an increased level of protection for the Facility owner.

Construction Core Program

How To Order

Use Quick Code CT6 for 6-PIN, CT7 for 7-PIN, and CTP for Access 3, Pyramid IC products. Use a separate purchase order or line item to order the permanent systems' core.

Cut Keys

Specify the required number of change keys and control keys on the order. Two control keys are provided at no charge. Two change keys are provided at no charge for the first 20 units ordered. One additional change key is provided for every 10 additional units at no charge.

Examples: 25 units provide 2 operating keys; 30 units provide 3; 100 units provide 10. Additional keys will be invoiced at the prevailing cut key price.

How To Return Cores

Contact your Customer Service Representative for a Returned Goods Authorization.

Provide the factory order number and year of the original order. Credit is issued for all cores returned in good operating condition, based on the price of a standard 6- or 7-pin core at the time of the original order. Applicable discounts to the original unit are applied to the returned core.

Current pricing is as follows:	Price
6-PIN CONSTRUCTION CORE: (e.g. 8000-CT6) returned for credit	\$80.00
7-PIN CONSTRUCTION CORE: (e.g. 8000-CT7) returned for credit	\$82.00

How To Price

Use Quick Code charts in lockset and exit device price sections.

1 ea. Lockset	ML2051 NSA 626	\$941.00	List Price
x Construction Core	CTP	\$74.00	List Price
		\$1,015.00	Subtotal
	Less 50/25% discount	\$380.63	Subtotal Net Price
1 ea. Pyramid Permanent Core	CR8027 x 626	\$129.00	List Price
	Less 50% discount	\$64.50	Net Price
		\$445.13	Subtotal Net Price
Return Construction Core	8000 Construction Core	\$74.00	List Price
	Less 50/25% discount	\$27.75	(Credit - RGA from factory)
		\$417.38	Your Total Cost

Cylinders for Competitor Products:

CORBIN RUSSWIN cylinders or cores for use in non-CORBIN RUSSWIN manufactured locking devices for which CORBIN RUSSWIN has an equivalent, will be assessed an additional Cylinder Service Fee. This fee applies to masterkeyed cylinder only orders, 1 bitted high security cylinders and zero or 1 bitted restricted cylinder orders.

Keying

Description	Specify Quick Code	Add or Deduct
Keyed random ³	KR	No Charge
Masterkey Service Fee. Applies to cylinders not being installed in Assa Abloy products		Consult Factory
Master keyed (all cylinders except CR8000, CR8020, CR8027 IC Core CR8500, CR8600, CR8700 core)	specify keyset	Add \$16.00 per cylinder
Master keyed Pyramid (except CR8020, CR8027 IC Core)	specify keyset	Add \$16.00 per cylinder
Master keyed Access 3 (except CR8500, CR8600, CR8700 IC Core)	specify keyset	Add \$16.00 per cylinder
Master keyed Security (including IC cylinder and core)	specify keyset	Add \$16.00 per cylinder
Master keyed (CR8000, CR8020, CR8027 IC Core CR8500, CR8600, CR8700)	specify keyset	No Charge
Master keyed to customer bittings or sample key	specify keyset	Add \$16.00 per cylinder
Construction master keyed ^{1,2}	CMK	Add \$16.00 per cylinder
Temporary Construction core, 6-pin (Red, Blue or Green) including Access 3 AP & AS	CT6R, CT6B, CT6G	No Charge
Temporary Construction core, 7-pin (Red, Blue or Green)	CT7R, CT7B, CT7G	No Charge
Temporary Construction core, 6-pin (Red, Blue or Green) Access 3 AHS	CT6AHR, CT6AHB, CT6AHG	No Charge
Temporary Construction core, Access 3 Pyramid	CTP	No Charge
Temporary Disposable core ⁶	CT6D, CT7D, CTPD	No Charge
Small Format Temporary Disposable Cores ⁶	CTSD	No Charge
Uncombined (Access 3, Pyramid, Security fixed and IC core) ⁷	UC	Deduct \$8.00
Uncombined (conventional CR8000 IC core) ⁷	UC	Deduct \$2.00
Bump-Resistant Cylinder; Standard on Access 3 except LFIC	BRP	Add \$23.00 per cylinder
More than 2 keys per lock	KY# (e.g., KY6)	See Cut Keys Section Below

Stamping

Visual key control (VKC)		
- No stamping	VKC0	\$4.50
- Keys only	VKC1	No Charge
- Cylinders and Keys ⁴	VKC2	\$8.00
- Cylinders only ⁴	VKC3	\$8.00
Concealed key control (CKC)		
- CKC cylinders with VKC keys	CKC2	\$8.00
- CKC cylinders only ⁴	CKC3	\$8.00
DO NOT DUPLICATE	Order by number	see pages 69-74
End user custom die stamps* for key bows		\$4.00
Other stamping on keys or cylinders (Up to 7 characters on cylinders)		\$3.00 per character

* For development of custom key stamp add one-time charge of \$840.00. Dies property of Corbin Russwin.

Cut Keys

	Conventional Keyway ⁵ Restricted Keyway		Protected Keyway		Security Keys	Pyramid Keys	Access 3		
	10 Series Bow	50 Series Bow	10 Series Bow	50 Series Bow	KB90 or KB92	KB28	AP	AS	AHS
Extra cut change keys with lockset/cylinder	\$5.30	\$5.80	\$6.30	\$6.70	\$19.50	\$10.30	\$5.20	\$10.30	\$10.30
Cut change keys without lockset/cylinder	\$11.00	\$11.50	\$12.00	\$12.40	\$19.50	\$15.00	\$11.00	\$16.10	\$16.10
Cut master keys (all levels) and control keys with or without lockset/cylinder	\$11.00	\$11.50	\$12.00	\$12.40	\$19.50	\$15.00	\$11.00	\$16.10	\$16.10
Cut construction master keys with or without lockset/cylinder	\$11.00	\$11.50	\$12.00	\$12.40	N/A	N/A	\$11.00	\$16.10	NA

Note: Two (2) cut change keys are provided per lockset or cylinder at no charge. Keyblanks cannot be substituted for cut keys. For keys with bows other than 10 and 90, specify "KB" + number as Quick Code, e.g. KB12. KB92 cannot be furnished with VKC or other markings. Cylinders pinned directly to GMK or MK level keys do not include cut keys. Please order GMK and MK keys separately.

Notes:

1. CMK Construction master keying charge is in addition to master keying charge.
2. CMK Construction master keying is not available in interchangeable core, Access 3, Pyramid, or Security series.
3. Access 3 and Pyramid series is not available keyed random or 0-bit. All LFIC cylinders unavailable keyed random.
4. VKC2, VKC3 is not available in Access 3, Pyramid or Security series.
5. Conventional cut change keys are furnished standard with key section, system type and biting number.
6. Disposable cores ordered separately - \$43.00 per set. Sold in multiples of 10 sets.
7. Keys, springs, and spring covers not included.

Presentation Keys		Price
Specify:	Key Symbol; Plating (nickel is standard); Stamping; Bow, if available for key class	
Standard Bow:	51 for all except below	
	90 for Security series	Nickel Plated \$112.00
	10 for 6PIN 852 & A Class keys	Gold Plated \$215.00

Bitting Lists

A letter of authorization from the end user is required to release a copy of the bitting lists for a factory established system. To protect the security of keying systems, bitting lists will only be sent to the end user or his designated agent, via Certified Mail Return Receipt Requested or UPS AOD. Copies will not be transmitted via fax. The complete name and address where the bitting list is to be sent must be indicated on the letter of authorization and on the purchase order.

Master key system bitting lists will not be created by Corbin Russwin Key Systems Administration unless the request is accompanied by an order for factory keyed product. Corbin Russwin releases all liabilities for cylinders not pinned to factory master key systems.

Number of Bittings	Price
1-50	\$203.00
51-200	\$311.00
201-1000	\$415.00
1001-3000	\$523.00
3001-6000*	\$612.00
6001-9000*	\$908.00
Over 9000*	Consult Key Systems Administration

*Lead times may vary; consult Key Systems Administration

NOTE: Bitting Lists requested for keysets ordered with factory keyed product for either a new or existing system will be provided at no charge, except when KeyWizard® software requested. For existing system pricing above will apply. For new system see page 50.

- Additional Bittings or P.O.'s for Bitting Lists Only – **EXISTING MASTER KEY GROUPS**
Up to 10 **total** for keysets tied to **existing** master key groups will be provided at no charge
11 or more bittings will be charged per above chart
- Additional Bittings or P.O.'s for Bitting Lists Only – **NEW MASTER KEY GROUPS**
Regardless of the quantity being requested, will be charged per above chart

These prices are for a hierarchical Master Key system with no cross-keying of selected keys.
For special requirements or for systems prior to 1999, consult Key Systems Administration for a quote.

Corbin Russwin releases all liabilities for cylinders not pinned to factory master key systems.

Cylinders for Competitor Products:

CORBIN RUSSWIN cylinders or cores for use in non-CORBIN RUSSWIN manufactured locking devices for which CORBIN RUSSWIN has an equivalent, will be assessed an additional Cylinder Service Fee. This fee applies to masterkeyed cylinder only orders, 1 bitted high security cylinders and zero or 1 bitted restricted cylinder orders.

Key Management Software		Price
Key Wizard® – Special online ordering procedures accessible via the ASSA ABLOY Door Security Solutions Extranet (www.assaabloydss.com) - contact customer service for more information.		
Single Version – Order part number 68092		\$1,290.00
Network Version – Order part number 68093		\$1,516.00
Upgrade from Single Version to Network Version - Order part number 68095		\$779.00
Corbin Russwin factory key system formatted for importing to KeyWizard®. For existing systems, see Bitting Lists pricing on page 65. Note: Not available for key systems established prior to 1999. May not be available for systems since 1999. Consult Key Systems Administration for eligibility of system.		\$597.00
Key Systems Administration		Price
Customer bittings and sample keys 1,2,3,4,5		Add \$16.00 per cylinder
<p>Notes:</p> <ol style="list-style-type: none"> 1. This charge is for keying to customer supplied bittings only. 2. All cylinders requested to be keyed to combinations not supplied by Corbin Russwin will be subject to this charge. 3. Corbin Russwin releases all liabilities, including key interchange, to systems generated by customer-supplied bittings and/or sample keys that are supplied by others. 4. Purchase orders with customer-supplied bittings or sample keys not meeting Corbin Russwin's specifications will be processed 0-bitted in the specified keyway and exempt from upcharge. 5. Master keying or CMK charges not included. <p>Disclaimer Corbin Russwin reserves the right to release total liability of any factory generated master key system which incorporates cross keying, both controlled and uncontrolled. A master key system incorporating cross keying yields less security and jeopardizes system expansion.</p> <p>Controlled Cross Keying: A condition in which two or more different keys of the same level of keying and under the same higher level</p>		
Cross Keying		No Charge
<p>key(s) operate one cylinder by design; e.g., XAA1 operated by AA2.</p> <p>Uncontrolled Cross Keying: A condition in which two or more different keys under different higher-level keys operate one cylinder by design; e.g., XAA1 operated by AB, AB1.</p>		

Stamping Key Section on Key Blanks

Key blanks are furnished standard with no key section ID. When so specified, key blanks can be stamped with the key section at no charge.
The minimum quantity for this service is a box of 50 key blanks

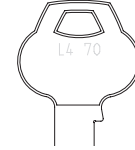
Standard Bow, Nickel Silver (Order in multiples of 50)

Coined Logo	Plain Both Sides	DO NOT DUPLICATE	US PROPERTY DO NOT DUPLICATE	RESTRICTED DO NOT DUPLICATE	Price Each		
					Standard Single Section	Restricted Single Section	Standard and Restricted Multi-Section**
(X1, Z1, R)*	(X4, Z4, P)*	(X5, Z5, P5)*	(X6, Z6, P6)*				
xx-5PIN-10	xx-5PIN-11	xx-5PIN-12	xx-5PIN-13	xx-5PIN-19	\$2.20	\$2.35	\$2.50
xx-6PIN-10	xx-6PIN-11	xx-6PIN-12	xx-6PIN-13	xx-6PIN-19			
xx-7PIN-10	xx-7PIN-11	xx-7PIN-12	xx-7PIN-13	xx-7PIN-19	\$2.27	\$2.42	\$2.52

*(Old Reference)

**Multi-section keys enter more than one keyway; eg. D12, H41, 2852, 9812, 59A, 57AD, 067, etc.

¹ Protected keyway keys will be stamped "Restricted"

Pyramid (Available in quantities of 10, 25, 50 and multiples of 50)

Standard bow furnished for all Pyramid Keys.



Key Blank Number	Description	Price Each
XX-7PIN-28	Single section	\$7.40
	Multi-section	\$14.00

Access 3

Key Blank Number	Description	Price Each
6PIN-38-AP	Standard key blanks for AP cylinders	\$3.90
6PIN-38-AS	Standard key blanks for AS & AHS cylinders	\$7.40

Security Bow No other shape for security keys. (Order in multiples of 50)

Not Available for 252, 752, 852, A, N, or X Class keys.
Inactive, for existing systems only.



Coined Logo	Plain Both Sides	DO NOT DUPLICATE	US PROPERTY DO NOT DUPLICATE	RESTRICTED DO NOT DUPLICATE	Price Each
xx-6PIN-90	xx-6PIN-91	xx-6PIN-92	xx-6PIN-93	xx-6PIN-99	\$7.40
xx-7PIN-90 for hotel EMK					\$9.60

Large Bows (Order in multiples of 50)

Large Not Available for 252, 752, 852 or A Class keys.



Plain Both Sides	DO NOT DUPLICATE	US PROPERTY DO NOT DUPLICATE	RESTRICTED DO NOT DUPLICATE	Price Each	PROTECTED DO NOT DUPLICATE	Price Each
(Y4 and S)	(Y5 and S5)	(Y6 and S6)				
xx-5PIN-51	xx-5PIN-52	xx-5PIN-53	xx-5PIN-59	\$3.50	xx-5PIN-59	\$5.30
xx-6PIN-51	xx-6PIN-52	xx-6PIN-53	xx-6PIN-59		xx-6PIN-59	
xx-7PIN-51	xx-7PIN-52	xx-7PIN-53	xx-7PIN-59		xx-7PIN-59	

Emergency Key Blanks for Hotel Function Access 3 Cylinder

Description	Key Number	Price Each
Emergency key for mortise AP cylinders	6PIN-38-E2-AP	\$5.40
Emergency key for mortise AS & AHS cylinders	6PIN-38-E2-AS	\$7.60
Emergency key for key-in lever AP cylinders	6PIN-38-E6-AP	\$5.40
Emergency key for key-in lever AS & AHS cylinders	6PIN-38-E2-AS	\$7.60

Emergency Master Key Blanks for Hotel Function Cylinder (Order in multiples of 10)
 Non-IC mortise cylinder use 7PIN blanks, as already listed: xx-7PIN-51 & xx-7PIN-90. (Order in multiples of 50)

Not Available for 252, 752, 852 or A Class keys.



Lockset	EMK Blank	Price Each
IC Mortise	xx-6PIN-51-E1	\$5.40
IC Mortise, Security	xx-6PIN-90-E1	\$7.60
CK4229, including IC; CK4429	xx-6PIN-51-E4	\$5.40
CK4229 Security, Including IC	xx-6PIN-90-E4	\$7.60
CL3329, CL3429, CL3629 6PIN, Including IC	xx-6PIN-51-E8	\$5.40
CL3329, CL3429, CL3629 7PIN, Including IC	xx-7PIN-51-E8	\$5.40
1400/4300 and 5600/3300 Series	xx-6PIN-51-E5	\$6.40

Mortise Cylinder

Cylinder Number	Description	605, 606, 611, 612, 613, 613E, 618, 619, 622, 625, 626, 629, 630, 722, BSP, WSP
CR1500-114	ML2000 Series mortise locks (including electrified and EAC devices)	\$93.00
CR1500-114	DL3000 and DL4100 deadlocks	
CR1500-112	ED5600, ED6600 and ED7600 exit devices	
CR1500-134	All ED5000 cylinder dogging, alarm units, delayed egress cylinders	
CR1501-114-A01	AP Hotel Mortise Cylinder	\$129.00

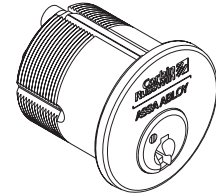

Rim Cylinder

Cylinder Number	Description	605, 606, 611, 612, 613, 613E, 618, 619, 622, 625, 626, 629, 630, 722, BSP, WSP
CR3500-058	5/8" tailpiece	\$93.00
CR3500-138	1-3/8" M61 & M62 option for ED8200 and obsolete ED9200 exit device alarms; ED5202(A) inside cylinder	
CR3500-200	2" tailpiece	
CR3500-200N	2" ED4000/ED5000 night latch function	
CR3500-200V	2" vertical tailpiece	\$95.00
CR3500-312	3-1/2" tailpiece	
CR3500-312V	3-1/2" vertical tailpiece	

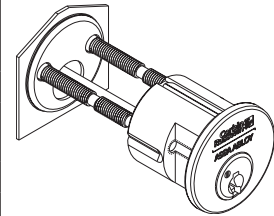

AP LFIC - Mortise Cylinder

Cylinder Number	Description	605, 606, 611, 612, 613, 613E, 618, 619, 622, 625, 626, 629, 630, 722, BSP, WSP
CR1580-114	ML2000 Series mortise locks (including electrified and EAC devices)	\$173.00
CR1580-138	DL3000 and DL4100 deadlocks	\$176.00
CR1580-112	ED5600, ED6600 and ED7600 exit devices	
CR1580-134	All ED5000 cylinder dogging, alarm units, delayed egress cylinders	

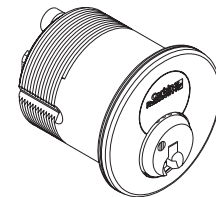

AP LFIC - Rim Cylinder

Cylinder Number	Description	605, 606, 611, 612, 613, 613E, 618, 619, 622, 625, 626, 629, 630, 722, BSP, WSP
CR3580-058	5/8" tailpiece	\$173.00
CR3580-114	1-1/4" M61 & M62 option for ED8200 and ED9200 exit device alarms	
CR3580-178	1-7/8" tailpiece	
CR3580-178V	1-7/8" vertical tailpiece	
CR3580-318	3-1/8" tailpiece	\$175.00

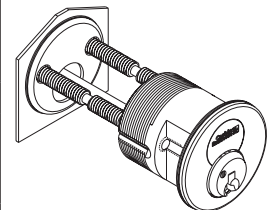

AP LFIC Core

Cylinder Number	Description	605, 606, 611, 612, 613, 613E, 618, 619, 622, 625, 626, 629, 630, 722, BSP, WSP
CR8500	All Corbin Russwin LFIC cylinders	\$80.00

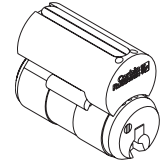

AP Fixed Core Component Cylinder

Cylinder Number	Description	Finish: 606, 626
CR2500-031	CL3100 Series Vandal Resistant, CK4300 Knob	\$86.00
CR2500-033	CL3300, CL3500, CL3600 (June 2000 and after), CL3800, Lever Trim - A6/N6/PR6	
CR2500-033H	G10 Exit Device Knob Trim	
CR2500-037	CL3700 Lever, CK4700 Knob	
CR2500-039	CL3900	
CR2500-039L	CL3900 Lever (2" and 2-1/4" Thick Door)	
CR2500-044	CK4400	
CR2500-052	CK4200/UT5200	

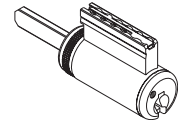

AP Fixed Core Deadlock Cylinder

Cylinder Number	Description	Finish: 606, 626
CR4500-134-A51	DL2200/DL3200 Series	\$86.00
CR4500-134-A52		
CR4500-214-A52		

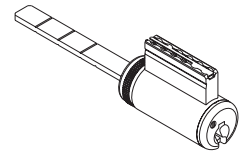

AP Fixed Core Hotel Cylinder

Cylinder Number	Description	Finish: 606, 626
CR2501-031	CL3100 Series Vandal Resistant	\$100.00
CR2501-034	CL3300	

AS Fixed Core - Mortise Cylinder

Cylinder Number	Description	605, 606, 611, 612, 613, 613E, 618, 619, 622, 625, 626, 629, 630, 722, BSP, WSP
CR1600-114	ML2000 Series mortise locks (including electrified and EAC devices)	\$142.00
CR1600-138	DL3000 and DL4100 deadlocks	
CR1600-112	ED5600, ED6600 and ED7600 exit devices	\$152.00
CR1600-134	All ED5000 cylinder dogging, alarm units, delayed egress cylinders	

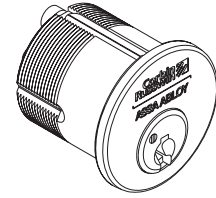

AS Fixed Core - Rim Cylinder

Cylinder Number	Description	605, 606, 611, 612, 613, 613E, 618, 619, 622, 625, 626, 629, 630, 722, BSP, WSP
CR3600-058	5/8" tailpiece	\$142.00
CR3600-138	1-3/8" M61 & M62 option for ED8200 and obsolete ED9200 exit device alarms; ED5202(A) inside cylinder	
CR3600-200	2" tailpiece	
CR3600-200N	2" night latch function	
CR3600-200V	2" vertical tailpiece	
CR3600-312	3-1/2" tailpiece	\$144.00
CR3600-312V	3-1/2" vertical tailpiece	

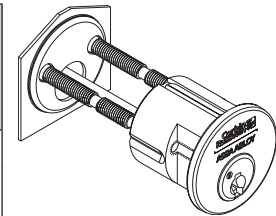

AS LFIC - Mortise Cylinder

Cylinder Number	Description	605, 606, 611, 612, 613, 613E, 618, 619, 622, 625, 626, 629, 630, 722, BSP, WSP
CR1680-114	ML2000 Series mortise locks (including electrified and EAC devices)	\$222.00
CR1680-138	DL3000 and DL4100 deadlocks	\$225.00
CR1680-112	ED5600, ED6600 and ED7600 exit devices	
CR1680-134	All ED5000 cylinder dogging, alarm units, delayed egress cylinders	\$233.00

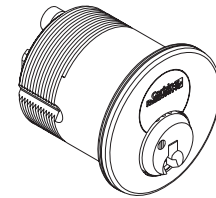

AS LFIC - Rim Cylinder

Cylinder Number	Description	605, 606, 611, 612, 613, 613E, 618, 619, 622, 625, 626, 629, 630, 722, BSP, WSP
CR3680-058	5/8" tailpiece	\$222.00
CR3680-114	1-1/4" M61 & M62 option for ED8200 and ED9200 exit device alarms	
CR3680-178	1-7/8" tailpiece	
CR3680-178V	1-7/8" vertical tailpiece	
CR3680-318	3-1/8" tailpiece	

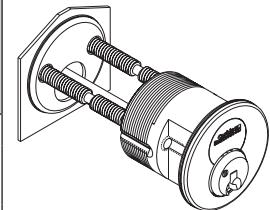

AS LFIC Core

Cylinder Number	Description	605, 606, 611, 612, 613, 613E, 618, 619, 622, 625, 626, 629, 630, 722, BSP, WSP
CR8600	All Corbin Russwin LFIC Cylinders	\$129.00

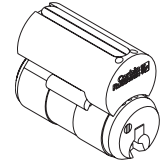

AS Fixed Core Component Cylinder

Cylinder Number	Description	Finish: 606, 626
CR2600-031	CL3100 Series Vandal Resistant, CK4300 Knob	\$135.00
CR2600-033	CL3300, CL3500, CL3600 (June 2000 and after), CL3800, Lever Trim - A6/N6/PR6	
CR2600-033H	G10 Exit Device Knob Trim	
CR2600-037	CL3700 Lever, CK4700 Knob	
CR2600-039	CL3900	
CR2600-039L	CL3900 Lever (2" and 2-1/4" Thick Door)	
CR2600-044	CK4400	
CR2600-052	CK4200/UT5200	

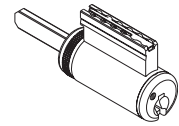

AS Fixed Core Deadlock Cylinder

Cylinder Number	Description	Finish: 606, 626
CR4600-134-A51	DL2200/DL3200 Series	\$135.00
CR4600-134-A52		
CR4600-214-A52		

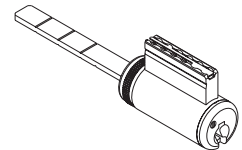

AS Fixed Core Hotel Cylinder

Cylinder Number	Description	Finish: 606, 626
CR2601-031	CL3100 Series Vandal Resistant	\$149.00
CR2601-034	CL3300	

AHS Fixed Core - Mortise Cylinder

Cylinder Number	Description	605, 606, 611, 612, 613, 613E, 618, 619, 622, 625, 626, 629, 630, 722, BSP, WSP
CR1700-114	ML2000 Series mortise locks (including electrified and EAC devices)	\$162.00
CR1700-138	DL3000 and DL4100 deadlocks	
CR1700-112	ED5600, ED6600 and ED7600 exit devices	\$172.00
CR1700-134	All ED5000 cylinder dogging, alarm units, delayed egress cylinders	

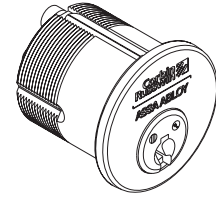

AHS Fixed Core - Rim Cylinder

Cylinder Number	Description	605, 606, 611, 612, 613, 613E, 618, 619, 622, 625, 626, 629, 630, 722, BSP, WSP
CR3700-058	5/8" tailpiece	\$162.00
CR3700-138	1-3/8" M61 & M62 option for ED8200 and obsolete ED9200 exit device alarms; ED5202(A) inside cylinder	
CR3700-200	2" tailpiece	
CR3700-200N	2" night latch function	
CR3700-200V	2" vertical tailpiece	\$164.00
CR3700-312	3-1/2" tailpiece	
CR3700-312V	3-1/2" vertical tailpiece	

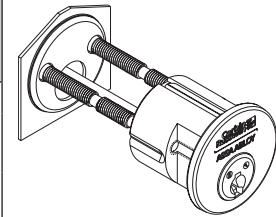

AHS LFIC - Mortise Cylinder

Cylinder Number	Description	605, 606, 611, 612, 613, 613E, 618, 619, 622, 625, 626, 629, 630, 722, BSP, WSP
CR1788-114	ML2000 Series mortise locks (including electrified and EAC devices)	\$242.00
CR1788-138	DL3000 and DL4100 deadlocks	\$245.00
CR1788-112	ED5600, ED6600 and ED7600 exit devices	
CR1788-134	All ED5000 cylinder dogging, alarm units, delayed egress cylinders	\$253.00

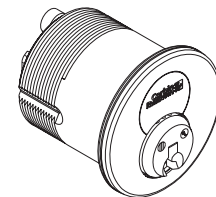

AHS LFIC - Rim Cylinder

Cylinder Number	Description	605, 606, 611, 612, 613, 613E, 618, 619, 622, 625, 626, 629, 630, 722, BSP, WSP
CR3788-058	5/8" tailpiece	\$242.00
CR3788-114	1-1/4" M61 & M62 option for ED8200 and ED9200 exit device alarms	
CR3788-178	1-7/8" tailpiece	\$244.00
CR3788-178V	1-7/8" vertical tailpiece	
CR3788-318	3-1/8" tailpiece	

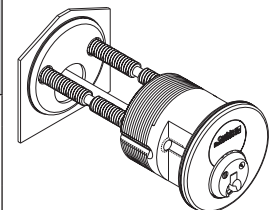

AHS LFIC Core

Cylinder Number	Description	605, 606, 611, 612, 613, 613E, 618, 619, 622, 625, 626, 629, 630, 722, BSP, WSP
CR8700	All Corbin Russwin LFIC cylinders	\$149.00

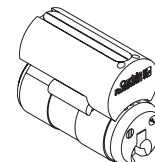

AHS Fixed Core Component Cylinder

Cylinder Number	Description	Finish: 606, 626
CR2700-031	CL3100 Series Vandal Resistant, CK4300 Knob	\$155.00
CR2700-033	CL3300, CL3500, CL3600 (June 2000 and after), CL3800, Lever Trim - A6/N6/PR6	
CR2700-033H	G10 Exit Device Knob Trim	
CR2700-037	CL3700 Lever, CK4700 Knob	
CR2700-039	CL3900	
CR2700-039L	CL3900 Lever (2" and 2-1/4" Thick Door)	
CR2700-044	CK4400	
CR2700-052	CK4200/UT5200	

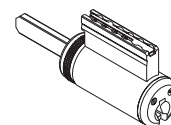

AHS Fixed Core Hotel Cylinder

Cylinder Number	Description	Finish: 606, 626
CR2701-031	CL3100 Series Vandal Resistant	\$169.00
CR2701-034	CL3300	

AHS Fixed Core Deadlock Cylinder

Cylinder Number	Description	Finish: 606, 626
CR4700-134-A51	DL2200/3200 Series	\$155.00
CR4700-134-A52		
CR4700-214-A52		

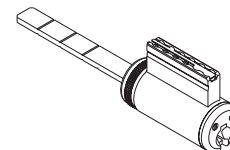

UL LFIC 6-Pin Mortise Housing

Cylinder Number	Description	605, 606, 611, 612, 613, 613E, 618, 619, 622, 625, 626, 629, 630, 722, BSP, WSP
CR1078-114	ML2000 Series mortise locks (including electrified and EAC devices)	\$93.00
CR1078-138	DL3000 and DL4100 deadlocks	\$96.00
CR1078-112	ED5600, ED6600 and ED7600 exit devices	
CR1078-134	All ED5000 cylinder dogging, alarm units, delayed egress cylinders	\$104.00

UL LFIC 6-Pin Rim Housing

Cylinder Number	Description	605, 606, 611, 612, 613, 613E, 618, 619, 622, 625, 626, 629, 630, 722, BSP, WSP
CR3078-058	5/8" tailpiece	\$93.00
CR3078-114	1-1/4" M61 & M62 option for ED8200 and ED9200 exit device alarms	
CR3078-178	1-7/8" tailpiece	
CR3078-178V	1-7/8" vertical tailpiece	
CR3078-318	3-1/8" tailpiece	\$95.00

Fixed Core Mortise

7-Pin - No Cross Keying - Furnished standard with 610502 solid recessed collar unless otherwise indicated.
High Security UL437 Listed.

Cylinder Number Example

To simplify ordering, options designated "standard" may be omitted from the ordering sequence.

CR1020 - 114 - A01 - 626



Length		Cam	Finish	
114	(1-1/4")	A01	605	622
		A02	606	625
112	(1-1/2")	A03	611	626
		A04	612	629
		A05	613	630
		A06 ²	613E	722
		A07	618	BSP
		A62	619	
		A92		
		A93 ¹		
Cylinder No.			Price	
CR1020-114			\$189.00	

- Notes: 1. Add \$2.00 per cylinder for A93 cam
- 2. Add \$5.00 per cylinder for A06 cam

Fixed Core Rim

7-Pin - No Cross Keying - Furnished standard with 422F88 surface mount collar unless otherwise indicated.
High Security UL437 Listed.

Cylinder Number Example

CR3020 - 200 - 626

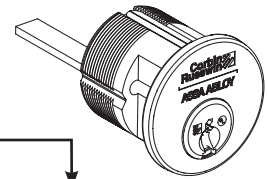

Tailpiece Length	Finish	
058 - 5/8"	605	622
138 - 1-3/8" M61 & M62 option for ED8200 and obsolete ED9200 exit device alarms	606	625
200 - 2"	611	626
200N - 2" ED4000/ED5000 Night Latch Function	612	629
200V - 2" vertical	613	630
312 - 3-1/2"	613E	722
312V - 3-1/2" vertical	618	BSP
	619	
Cylinder Number	Price	
CR3020 - _____	\$189.00	

Key-In-Lever/Knob

7-Pin - No Cross Keying

High Security UL437 Listed

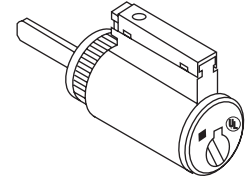

Cylinder Number	Used for	Finish: 606, 626
CR2020-031	CL3100 Lever, CK4300 Knob	\$180.00
CR2020-033	CL3300, CL3500, CL3800 [CL3600 (June 2000 and after)], A6, N6, PR6 Exit device trim	
CR2020-033H	G10 Exit device trim	
CR2020-034	CL3400, [CL3600 (prior to June 2000)], A5, N5 obsolete ED8000 trims	
CR2020-037	CL3700 Lever, CK4700 Knob	
CR2020-038	CL3800 Lever	
CR2020-039	CL3900 Lever	
CR2020-039L	CL3900 Lever (2"- 2-1/4" door)	
CR2020-051	G3 Exit Device Knob Trim	
CR2020-052	CK4200 Knob, UT5200 Knob and Lever	
CR4420-134-A51	DL2200, DL3200 Cylindrical Deadlock	
CR4420-134-A52	DL2200, DL3200 Cylindrical Deadlock	
CR4420-214-A52	DL2200, DL3200 Cylindrical Deadlock	

Key-In-Lever/Knob

For Other Manufacturers' Products

High Security UL437 Listed

Cylinder Number	Used for	Finish: 606, 626
CR2220-001-P21	Alarm Lock DL2500 Series	\$182.00
	Arrow® H Series Knobs and Levers	
	Arrow Q Series Levers	
	Sargent® 10 line*	
	Schlage® D Series Levers	
CR2220-002-P21	Schlage D Series Knobs	
CR2220-001-P22	Schlage AL and ND Series Levers	
CR2220-002-P22	Schlage A Series Knobs (PLY, etc.)	
CR2220-002-P23	Schlage A Series Knob (ORB only)	

* When ordered with a 30- prefix, this cylinder is accepted without modification to the lever.

IC Mortise

7-Pin - No Cross Keying - Furnished standard with 610F02 solid recessed collar unless otherwise indicated.

Cylinder Number Example

To simplify ordering, options designated "standard" may be omitted from the ordering sequence.

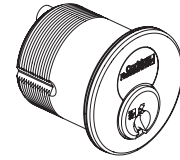

Length		Cam		Finish	
114	1-1/4"	A01	Cloverleaf (standard)	605	622
138	1-3/8"	A02	Straight	606	625
112	1-1/2"	A03	Adams Rite® MS & DL3000	611	626
134	1-3/4"	A04	DL4000 Deadlock	612	629
		A05	Adams Rite® 4070	613	630
		A06 ²	Schlage® L9000	613E	722
		A07	DL4100 Series Deadlock	618	BSP
		A62	Straight	619	
		A92	Exit Grip 01, 02		
		A93 ¹	For Obsolete Corbin® 610 Series and Russwin® 1403 Series Deadlock		
Cylinder Number				Price	
CR1030-114				\$264.00	

Notes: 1. Add \$2.00 per cylinder for A93 cam.
2. Add \$5.00 per cylinder for A06 cam.

IC Rim

7-Pin - No Cross Keying - Furnished standard with 422F88 surface mount collar unless indicated.

Cylinder Number Example

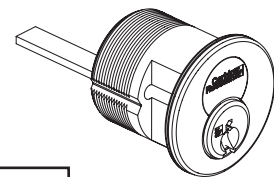

Tailpiece Length	Finish	
058 - 5/8"	605	622
	606	625
114 - 1-1/4" M61 & M62 option for ED8200 and ED9200 exit device alarms	611	626
	612	629
178 - 1-7/8"	613	630
	613E	722
178V - 1-7/8" vertical	618	BSP
318 - 3-1/8"	619	
Cylinder Number		Price
CR3030-_____		\$264.00

Pyramid Core Only

Cylinder Number	Price
CR8020	\$171.00

Note: For mortise and rim housing only, see page 93.

Fixed Core Mortise

7-Pin - No Cross Keying - Furnished standard with 605F43 spring collar unless otherwise indicated.

Cylinder Number Example

To simplify ordering, options designated "standard" may be omitted from the ordering sequence.

CR1027 - 114 - A01 - 626



Length	Cam	Finish	
114 (1-1/4")	A01 Cloverleaf (standard)	605	622
112 (1-1/2")	A02 Straight	606	625
	A03 Adams Rite® MS	611	626
	A04 DL4000 Deadlock	612	629
	A05 Adams Rite 4070	613	630
	A06 ² Schlage® L9000	613E	722
	A07 DL4100 Series Deadlock	618	BSP
	A62 Straight	619	
	A92 Exit Grip O1, O2		
	A93 ¹ For Obsolete Corbin® 610 Series and Russwin® 1403 Series Deadlock		

Cylinder Number	Price
CR1027-114	\$157.00

- Notes: 1. Add \$2.00 per cylinder for A93 cam.
2. Add \$5.00 per cylinder for A06 cam.

Fixed Core Rim

7-Pin - No Cross Keying - Furnished standard with 422F88 surface mount collar unless otherwise indicated.

Cylinder Number Example

CR3027 - 200 - 626

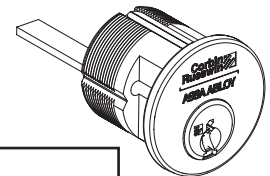

Tailpiece Length	Finish	
058 - 5/8"	605	622
138 - 1-3/8" M61 & M62 option for ED8200 and obsolete ED9200 exit device alarms	606	625
200 - 2"	611	626
200N - 2" ED4000/ED5000 Night Latch Function	612	629
200V - 2" (vertical)	613	630
312 - 3-1/2"	613E	722
312V - 3-1/2" (vertical)	618	BSP
	619	

Cylinder Number	Price
CR3027-_____	\$157.00

Key-In-Lever/Knob

7-Pin - No Cross Keying.

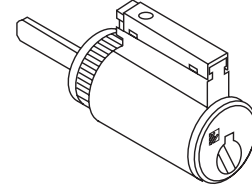

Cylinder Number	Used for	Finish: 606, 626
CR2027-031	CL3100 Lever, CK4300 Knob	\$150.00
CR2027-033	CL3300, CL3500, CL3800 [CL3600 (June 2000 and after)], A6, N6, PR6 Exit Device Trim	
CR2027-033H	G10 Exit device trim	
CR2027-034	CL3400, [CL3600 (before June 2000)], A5, N5 obsolete ED8000 trims	
CR2027-037	CL3700 Lever, CK4700 Knob	
CR2027-038	CL3800 Lever	
CR2027-039	CL3900 Lever	
CR2027-039L	CL3900 Lever (2" - 2-1/4" door)	
CR2027-051	G3 Exit Device Knob Trim	
CR2027-052	CK4200 knob, UT5200 Knob and Lever	
CR4427-134-A51	DL2200, DL3200 Cylindrical Deadlock	
CR4427-134-A52	DL2200, DL3200 Cylindrical Deadlock	
CR4427-214-A52	DL2200, DL3200 Cylindrical Deadlock	

Key-In-Lever/Knob

For Other Manufacturer's Products

Cylinder Number	Used for	Finish: 606, 626
CR2227-001-P21	Alarm Lock DL2500 Series	\$152.00
	Arrow® H Series Knobs and Levers	
	Arrow Q Series Levers	
	Sargent® 10 line (Enlarge Lever Hole)	
	Schlage® D Series Levers	
CR2227-002-P21	Schlage D Series Knobs	
CR2227-001-P22	Schlage AL and ND Series Levers	
CR2227-002-P22	Schlage A Series Knobs (PLY, etc.)	
CR2227-002-P23	Schlage A Series Knob (ORB only)	

IC Mortise

7-Pin - No Cross Keying - Furnished standard with 605F43 spring collar unless otherwise indicated.

Cylinder Number Example

To simplify ordering, options designated "standard" may be omitted from the ordering sequence.

CR1037 - 114 - A01 - 626

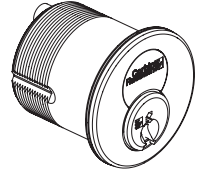

Length	Cam	Finish	
114 1-1/4"	A01 Cloverleaf (standard)	605	622
138 1-3/8"	A02 Straight	606	625
112 1-1/2"	A03 Adams Rite® MS & DL3000	611	626
134 1-3/4"	A04 DL4000 Deadlock	612	629
	A05 Adams Rite® 4070	613	630
	A06 ² Schlage® L9000	613E	722
	A07 DL4100 Series Deadlock	618	BSP
	A62 Straight	619	
	A92 Exit Grip 01, 02		
	A93 ¹ For Obsolete Corbin® 610 Series and Russwin® 1403 Series Deadlock		
Cylinder Number		Price	
CR1037-114		\$233.00	

- Notes: 1. Add \$2.00 per cylinder for A93 cam.
2. Add \$5.00 per cylinder for A06 cam.

IC Rim

7-Pin - No Cross Keying - Furnished standard with 422F88 surface mount collar unless otherwise indicated.

Cylinder Number Example

CR3037 - 178 - 626

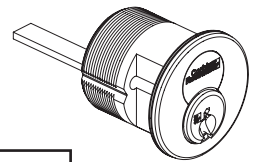

Tailpiece Length	Finish	
058 - 5/8"	605	622
114 - 1-1/4" M61 & M62 option for ED8200 and ED9200 exit device alarms	606	625
178 - 1-7/8"	611	626
	612	629
	613	630
178V - 1-7/8" vertical	613E	722
318 - 3-1/8"	618	BSP
	619	

Cylinder Number	Price
CR3037-_____	\$233.00

Pyramid Core Only

Cylinder Number	Price
CR8027	\$140.00

Note: For mortise and rim housing only, see page 93.

Standard Mortise

Cylinder Number Example

To simplify ordering, options designated "standard" may be omitted from the ordering sequence.



CR1000 - 118 - A01 - 6 - L4



Length	Cam	Pins	Keyway
100 1" (5-pin only)	A01 Cloverleaf (standard)	5	L4
118 1-1/8" (standard)	A02 Straight	6 (standard)	(standard)
114 1-1/4"	A03 Adams Rite® MS	7	
138 1-3/8"	A04 DL4000 Deadlock		
112 1-1/2"	A05 Adams Rite 4070		
134 1-3/4"	A06 ² Schlage® L9000		
200 2"	A07 DL4100 Series Deadlock		
	A62 Straight		
214 2-1/4"	A92 Exit Grip O1, O2		
212 2-1/2"	A93 ¹ For Obsolete		
234 2-3/4"	Corbin® 610 Series and Russwin® 1403 Series Deadlock		
300 3"			
314 3-1/4"			
312 3-1/2"			
334 3-3/4"			

Cylinder Number	Finish: 605, 606, 611, 612, 613, 613E, 618, 619, 622, 625, 626, 629, 630, 722, BSP, WSP	
	5- OR 6-PIN	7-PIN
CR1000-100-__- 5 - Keyway	\$93.00	Not Available
CR1000-118-__- - Keyway		
CR1000-114-__- - Keyway	\$93.00	\$95.00
CR1000-138-__- - Keyway		
CR1000-112-__- - Keyway	\$103.00	\$105.00
CR1000-134-__- - Keyway		
CR1000-200-__- - Keyway	\$113.00	\$115.00
CR1000-214-__- - Keyway		
CR1000-212-__- - Keyway	\$123.00	Not Available
CR1000-234-__- - Keyway		
CR1000-300-__- - Keyway		
CR1000-314-__- - Keyway		
CR1000-312-__- - Keyway		
CR1000-334-__- - Keyway		

- Notes:
 1. Add \$2.00 per cylinder for A93 cam.
 2. Add \$5.00 per cylinder for A06 cam.

Flexible Head Mortise

Cylinder Number Example

To simplify ordering, options designated "standard" may be omitted from the ordering sequence.

CR1100 - 118 - A01 - 6 - L4



Length	Cam	Pins	Keyway
100 1" (6-pin standard)	A01 Cloverleaf (standard)	5	L4
118 1-1/8"	A02 Straight	6 (standard)	(standard)
114 1-1/4"		7	

Cylinder Number	Finish: 605, 606, 611, 612, 613, 613E, 618, 619, 622, 625, 626, 722, BSP, WSP	
	5- OR 6-PIN	7-PIN
CR1100-100-__ - __ - Keyway	\$176.00	Not Available
CR1100-118-__ - __ - Keyway		\$178.00
CR1100-114-__ - __ - Keyway		\$180.00

Concealed Shell Mortise

Cylinder Number Example

To simplify ordering, options designated "standard" may be omitted from the ordering sequence.

CR1200 - 118 - A01 - 6 - L4



Length	Cam	Pins	Keyways
100 1" (5-pin standard)	A01 Cloverleaf (standard)	5	L4
118 1-1/8" (6-pin standard)	A02 Straight	6 (standard)	(standard)
114 1-1/4"		7	
138 1-3/8"			
112 1-1/2"			

Cylinder Number	Finish: 606, 626	
	5- OR 6-PIN	7-PIN
CR1200-100-__ - 5 - Keyway	\$140.00	\$142.00
CR1200-118-__ - __ - Keyway		
CR1200-114-__ - __ - Keyway		
CR1200-138-__ - __ - Keyway		\$142.00
CR1200-112-__ - __ - Keyway		

Special Function Mortise

Hotel Function* Cylinders

To simplify ordering, you may specify only the first 4 digits (1001, 1101, 1201).

Cylinder Number	Description	605, 606, 611, 612, 613, 613E, 618, 619, 622, 625, 626, 629, 630, 722, BSP, WSP
CR1001-114-A01	Standard	\$136.00
CR1101-118-A01	Flex Head	\$160.00
CR1201-114-A01	Concealed Shell	\$150.00

* Not available with D1, D2, L1, L2, 752, 852 or A class keyways.

Cylinder for Discontinued Exit Device

Inside of Corbin® 3726-1/2, 3727-1/2 and Russwin® 736-1/2, 737-1/2

Cylinder Number	605, 606, 611, 612, 613, 613E, 618, 619, 622, 625, 626, 629, 630, 722, BSP, WSP
CR1006-118-A02	\$114.00

Non-Keyed Mortise

Thumbturn Cylinders

Cylinder Number	Description	605, 606, 611, 612, 613, 613E, 618, 619, 622, 625, 626, 629, 630, 722, BSP, WSP
CR1300-100-A02	Standard*	\$93.00
CR1300-118-A02		
CR1300-114-A02	Standard*	\$97.00
CR1300-138-A02		
CR1300-100-A03	Standard*	\$93.00
CR1300-118-A03		
CR1300-114-A03	Standard*	\$97.00
CR1300-138-A03		
CR1300-118-A93	Standard*	\$95.00
CR1303-100-A03	Classroom*	
CR1303-118-A03		
CR1303-114-A03	Classroom*	\$99.00
CR1303-138-A03		

Dummy Cylinders

Cylinder Number	605, 606, 611, 612, 613, 613E, 618, 619, 625, 626, 629, 630, 722, BSP, WSP
CR1400-118	\$79.00
CR1400-114	\$83.00
CR1400-138	\$87.00

Rim Thumbturn Cylinders

Cylinder Number	605, 606, 611, 612, 613, 613E, 618, 619, 625, 626, 629, 630, 722, BSP, WSP
CR3300 -138	\$87.00
CR3300-138-M34	\$102.00
CR3300-200	\$87.00
CR3300-200-M34	\$102.00

* All CR1300 and CR1303 are available with M34 Ergonomic Thumbturn.

Rim (.552 dia. Plug)

Cylinder Number Example

To simplify ordering, options designated "standard" may be omitted from the ordering sequence.

CR3000 - 200 - 6 - L4

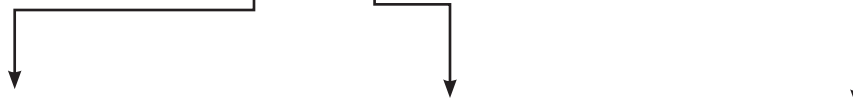
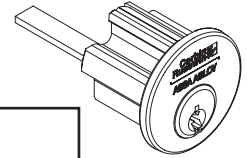

Tailpiece Length	Pins	Keyway
058 5/8"	5	L4 (Standard)
138 1-3/8" M61 & M62 option for ED8200 and obsolete ED9200 Exit Device Alarms	6 (Standard)	See page 61 for pricing of options.
200 2" (Standard)	7	
200N 2" ED4000/ED5000 Night Latch Function		
200V 2" Vertical		
312 3-1/2" (Thick door)		
312 3-1/2" (Thick door) Vertical		

Cylinder No.	605, 606, 611, 612, 613, 613E, 618, 619, 622, 625, 626, 629, 630, 722, BSP, WSP	
	5- OR 6-PIN	7-PIN
CR3000-058 ___ - Keyway	\$93.00	\$95.00
CR3000-138 ___ - Keyway		
CR3000-200- ___ - Keyway		
CR3000-200N- ___ - Keyway		
CR3000-200V- ___ - Keyway		
CR3000-312- ___ - Keyway	\$95.00	\$97.00
CR3000-312V- ___ - Keyway		

Key-In-Lever/Knob (.509" plug)

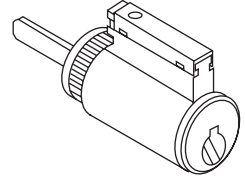

Cylinder Number		Finish: 606, 626		
		Series	6-PIN	7-PIN ⁴
CR2000-031	Standard	CL3100, CK4300	\$86.00	\$88.00
CR2001-031 ¹	Hotel	CL3100	\$100.00	\$102.00
CR2400-031-C ²	Schlage® C Keyway	CL3100	\$86.00	Not Available
CR2400-031-LA ³	Sargent® LA Keyway	CL3100		
CR2000-033	Standard	CL3300, CL3500, CL3600, CL3800 ^B		\$88.00
CR2000-038	Standard	CL3800 ^A		
CR2001-034 ¹	Hotel	CL3300		\$100.00
CR2400-033-C ²	Schlage® C keyway	CL3300, CL3500, CL3600, CL3800 ^B	\$86.00	Not Available
CR2400-033-LA ³	Sargent® LA keyway			
CR2000-037	Standard			
CR2400-037-C ²	Schlage® C keyway	CL3700, CK4700		
CR2400-037-LA	Sargent® LA keyway			
CR2000-039	Standard	CL3900	\$86.00	Not Available
CR2000-039L	2" to 2-1/4" Door			
CR2400-039-C ²	Schlage® C keyway			
CR2400-039-LA ³	Sargent® LA keyway			
CR2000-034	Standard	CL3400, CL3600 (Prior to June 2000)		
CR2001-034 ¹	Hotel		\$100.00	\$102.00
CR2400-034-C ²	Schlage® C keyway		\$86.00	Not Available
CR2400-034-LA ³	Sargent® LA keyway			

Notes:

1. Not available in 752, 852 or A Class keyways.
 2. Available 0-bitted & keyed random only.
 3. Available 0-bitted only.
 4. For 7-pin version suffix "-7" to number. Not available in 752, 852 or A Class keyways.
- A. CL3800 manf. 1993-1997
 B. CL3800 manf. 2006 -

Cylindrical Deadlocks DL2200, DL3200 Series

Cylinder Number	Door Thickness	Function	Finish: 606, 626 Price
CR4400-134-A51	6-Pin Conventional	All	\$86.00
CR4400-134-A52	6-Pin Conventional	1-3/8" to 1-3/4"	
CR4400-214-A52	6-Pin Conventional	2" to 2-1/4"	
CR4400-134-A51-7	7-Pin Conventional	All	\$88.00
CR4400-134-A52-7	7-Pin Conventional	1-3/8" to 1-3/4"	
CR4400-214-A52-7	7-Pin Conventional	2" to 2-1/4"	

Key-In-Lever/Knob

For UT5200 & CK4200 Series Locksets (.552" dia plug)

Cylinder Number	Description	Finish: 606, 626
CR2000-052	Standard	\$86.00
CR2001-052*	Hotel with Indicator	\$100.00
CR2100-052**	Discontinued Ronde & Continental Knob	\$100.00

For CK4400 Series Locksets (.509" dia plug)

Cylinder Number	Description	Finish: 606, 626
CR2000-044	All except below	\$86.00
CR2003-044	CK4455 & CK4482 before 8/93	
CR2001-044*	CK4429 with Indicator Pin New Style Straight Tailpiece	\$100.00
CR2001-066*	CK4429 with Indicator Pin Old Style Twisted Tailpiece	

For G10 Exit Device Knob Trim

Cylinder Number	Description	Finish: 606, 626
CR2000-033H	Standard	\$86.00

* Not available with 752, 852 or A Class keyways.

** Also available in 605, 611, 612, 613, 625 finishes. Not available with X Class keyways.

For PL5000 Series Rekeyable Fixed Core Padlocks

Cylinder Number	Description	Finish: 606, 626
CR2300	Standard 6-pin	\$86.00

For B2, G2, G3 Exit Device Trim

Cylinder Number	Description	Finish: 606, 626
CR2000-051	Standard 6-pin	\$86.00

Key-In-Lever/Knob (.552 dia Plug)

For Other Manufacturers' Products

Cylinder Number	Description	Finish: 606, 626
CR2200-001-A21	Alarm Lock DL2500 Series	\$90.00
	Arrow® H Series Knobs and Levers	
	Arrow Q Series Levers	
	Sargent® 10 line*	
	Schlage® D Series Levers	
CR2200-001-A22	Schlage AL and ND Series Levers	
CR2200-002-A21	Schlage D Series Knobs	
CR2200-002-A23	Schlage A Series Knobs (ORB only)	
CR2200-002-A22	Schlage A Series Knobs (PLY, etc.)	
CR2200-003-A24	Lockwood® H Series Knobs (Enlarge Knob Hole)	
CR2200-008	Sargent 7, 8, 9 Line (Enlarge Knob Hole)	
CR2200-054	Yale® 5400, 6200 Knobs Only (Enlarge Knob Hole)	
CR2200-076	Sargent 7600 Integrallock	\$96.00

* When ordered with a 30- prefix, this cylinder is accepted without modification to the lever.

For Adams Rite® 4025 Pull (.552" dia. Plug)

Cylinder Number	Description	Finish: 606, 626
CR4200-003-A47	Cylinder & Housing	\$146.00
CR4200-002-A47	Cylinder Only	\$86.00

IC Mortise

For Construction Core Program, see page 63.
For housing only, see page 93.

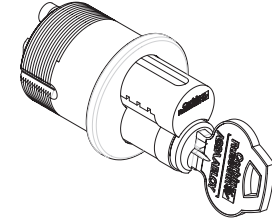

Cylinder Number Example

To simplify ordering, options designated "standard" may be omitted from the ordering sequence.

CR1080 - 114 - A01 - 6 - L4

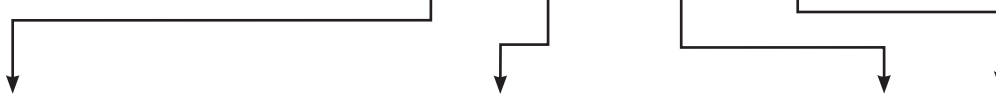

Length	Cam	Pins	Keyway
114 1-1/4" (6-pin standard)	A01 Cloverleaf (standard)	6 (standard)	L4 (standard)
138 1-3/8"	A02 Straight	7**	See page 61 for pricing of options.
112 1-1/2"	A03 Adams Rite® MS & DL300		
134 1-3/4"	A04 DL4000 Deadlock		
200 2"	A05 Adams Rite 4070		
214 2-1/4"	A06 ² Schlage® L9000		
212 2-1/2"	A07 DL4100 Series Deadlock		
234 2-3/4"	A62 Straight		
	A92 Exit Group 01, 02		
	A93 ¹ For obsolete Corbin® 610 Series and Russwin® 1403 Series Deadlocks		

Cylinder Number	605, 606, 611, 612, 613, 613E, 618, 619, 622, 625, 626, 629, 630, 722, BSP, WSP	
	6- PIN	7-PIN
CR1080-114-	\$173.00	Not Available
CR1080-138-	\$176.00	Not Available
CR1080-112-__-	\$176.00	\$180.00
CR1080-134-__-	\$184.00	\$188.00
CR1080-200-	\$184.00	\$188.00
CR1080-214-	\$190.00	\$194.00
CR1080-212-	\$196.00	\$200.00
CR1080-234-	\$200.00	\$204.00

- Notes:
1. Add \$2.00 per cylinder for A93 Cam.
2. Add \$5.00 per cylinder for A06 Cam.

Hotel Function IC Mortise

To simplify ordering, options designated "standard" may be omitted from the ordering sequence.

Cylinder Number	605, 606, 611, 612, 613, 613E, 618, 619, 622, 625, 626, 629, 630, 722, BSP, WSP	
	6-PIN	7-PIN
CR1081-138-A01-6** (Hotel function uses E1-suffix EMK blank)	\$187.00	Not Available

- ** Not available with 752, 852 or A Class keyways.
** Only available in 1-1/2" and 1-3/4" length.

IC Rim

For Construction Core Program, see page 63.
For housing only, see page 93.

Cylinder Number Example

To simplify ordering, options designated "standard" may be omitted from the ordering sequence.



CR3080 - 178 - 6 - L4



Tailpiece Length		Pins	Keyway
058	5/8" Tailpiece	6 Pin (standard)	L4 (standard)
178	1-7/8" (standard)	7 Pin	See page 61 for pricing of options
178V	1-7/8" Vertical		
318	3-1/8" (Thick door)		
114	1-1/4" M61 & M62 option for ED8200 and obsolete ED9200 exit device alarms		

Cylinder Number	605, 606, 611, 612, 613, 613E, 618, 619, 622, 625, 626, 629, 630, 722, BSP, WSP	
	6 PIN	7 PIN
CR3080-058-		
CR3080-178-__	\$173.00	\$177.00
CR3080-178V-__		
CR3080-318-__	\$175.00	\$179.00
CR3080-114-__ (no back plate or screw)	\$175.00	\$179.00

Core Only



Cylinder Number (specify keyway)	Finish: 626, 606
CR8000 6-Pin Standard	\$80.00
CR8000EMK* 6-Pin Standard set to hotel mortise EMK	
CR8000-7 7-Pin	\$82.00
CR8001-034* 6-Pin for CL3329, hotel indicator pin	\$96.00
CR8001-034-7* 7-Pin for CL3329, hotel indicator pin	\$98.00
CR8001-042* 6-Pin for CK4229, hotel indicator pin	\$96.00

* Not available with 752, 852 or A Class keyways.

Note: For uncombined cores suffix "UC". See page 48 for deduct.

LFIC Mortise Housing Only

Housing Number Example

To simplify ordering, options designated "standard" may be omitted from the ordering sequence.

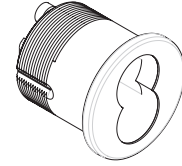

CR1070 - 114 - A01 - 6

Length	Cam		Pins
114 1-1/4" (6-pin standard)	A01	Cloverleaf (standard)	6 (standard)
138 1-3/8"	A02	Straight	7
112 1-1/2"	A03	Adams Rite® MS	
134 1-3/4"	A04	DL4000 Deadlock	
214 2-1/4"	A05	Adams Rite® 4070	
	A06 ²	Schlage® L9000	
	A07	DL4100 Series Deadlock	
	A62	Straight	
	A92	Exit Group 01, 02	
	A93 ¹	For obsolete Corbin® 610 Series and Russwin® 1403 Series Deadlocks	

Cylinder Number	605, 606, 611, 612, 613, 613E, 618, 619, 622, 625, 626, 629, 630, 722, BSP, WSP	
	6 PIN	7 PIN
CR1070-114-	\$93.00	Not Available
CR1070-138-	\$96.00	
CR1070-112-__-	\$96.00	\$98.00
CR1070-134-__-	\$104.00	\$106.00
CR1070-214-	\$110.00	Not Available
CR1071-138-A01 (Hotel function uses -E1 suffix EMK blank)	\$193.00	

Notes:

To simplify ordering, you may specify only "1071" since no length or cam variations exists.

1. Add \$2.00 per cylinder for A93 Cam.
2. Add \$5.00 per cylinder for A06 Cam.

LFIC Rim Housing Only

CR3070 - 058 - 626

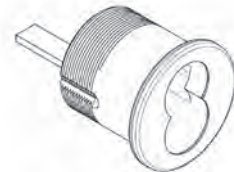

Cylinder Number	605, 606, 611, 612, 613, 613E, 618, 619, 622, 625, 626, 629, 630, 722, BSP, WSP	
	6 PIN	7 PIN
CR3070-058- 5/8" tailpiece	\$93.00	\$95.00
CR3070-178-__ 1-7/8" tailpiece (standard)		
CR3070-178V-__ 1-7/8" vertical		
CR3070-318-__ 3-1/8" tailpiece (thick door)	\$95.00	\$97.00
CR3070-114-__ 1-1/4" tailpiece for M61, M62 exit alarm options. No back plate or screws.		

SFIC Mortise Housing Only

Cylinder Number Example

CR1040 - 114 - A01 - 6

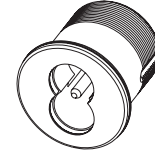

Length	Cam	Pins
114 1-1/4" (6-pin standard)	A01 Cloverleaf (standard)	6 (standard)
	A02 Straight	
	A03 Adams Rite® MS	
	A04 DL4000 Series Deadlock	
	A05 Adams Rite 4070	
	A06 Schlage® L9000	
	A07 DL4100 Series	
	A62 MR Straight	
	A93 Obsolete Deadlocks Corbin® 610 Series and Russwin® 1403 Series	
138 1-3/8" (7-pin standard) 112 1-1/2" (7-pin standard) 134 1-3/4" (7-pin standard)	A01 Cloverleaf (standard)	7
	A02 Straight	
	A03 Adams Rite® MS	
	A04 DL4000 Series Deadlock	
	A05 Adams Rite 4070	
	A06 Schlage® L9000	
	A07 DL4100 Series	
	A62 MR Straight	
	A93 Obsolete Deadlocks Corbin® 610 Series and Russwin® 1403 Series	

Cylinder Number	605, 606, 611, 612, 613, 613E, 618, 619, 622, 625, 626, 629, 630, 722, BSP, WSP	
	6 PIN	7 PIN
CR1040-114-__	\$93.00	Not Available
CR1040-138-__	\$96.00	\$98.00
CR1040-112-__	\$96.00	\$98.00
CR1040-134-__	\$104.00	\$106.00

SFIC Rim Housing Only

CR3040 - 058 - 626

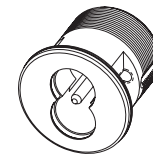

Cylinder Number		605, 606, 611, 612, 613, 613E, 618, 619, 622, 625, 626, 629, 630, 722, BSP, WSP	
		6 PIN	7 PIN
CR3040-058-	5/8" tailpiece	\$93.00	\$95.00
CR3040-178-__	1-7/8" tailpiece	\$93.00	\$95.00
CR3040-318-__	3-1/8" tailpiece	\$95.00	\$97.00

Standard Security Mortise

For Existing Systems Only.*
For uncombined cylinders, suffix "UC".
See page 48 for deduct.

6-Pin Only - No Cross Keying - Available in Z and DH Class Keyways only.
Available UC or master keyed only.
Not available KR or 0-bitted.

* L4, D1 and 60 keyway sections may be ordered Keyed Random only, without prior Key Systems Administration approval

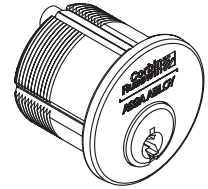

Cylinder Number Example

To simplify ordering, options designated "standard" may be omitted from the ordering sequence.

CR1010 - 118 - A01 - L4

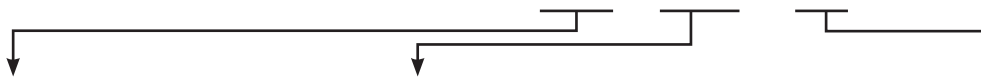

Length		Cam		Keyway
118	1-1/8" (standard)	A01	Cloverleaf (standard)	L4 (standard)
114	1-1/4"	A02	Straight	Available only with Z and DH Class keyways. See page 61 for pricing of options.
138	1-3/8"	A03	Adams Rite® MS & DL3000	
112	1-1/2"	A04	DL4000 Deadlock	
134	1-3/4"	A05	Adams Rite 4070	
200	2"	A06 ²	Schlage® L9000	
214	2-1/4"	A07	DL4100 Series Deadlock	
		A62	Straight	
		A92	Exit Grip 01, 02	
212	2-1/2"	A93 ¹	For obsolete Corbin® 610 Series and Russwin® 1403 Series Deadlocks	
234	2-3/4"			

Cylinder Number	605, 606, 611, 612, 613, 613E, 618, 619, 622, 625, 626, 629, 630, 722, BSP, WSP
CR1010-118-__	\$214.00
CR1010-114-__	
CR1010-138-__	\$222.00
CR1010-112-__	\$244.00
CR1010-134-__	\$254.00
CR1010-200-__	\$260.00
CR1010-214-__	\$266.00
CR1010-212-__	\$274.00
CR1010-234-__	\$278.00

- Notes:
1. Add \$2.00 per cylinder for A93 Cam.
 2. Add \$5.00 per cylinder for A06 Cam.

Special Function Security Mortise

For Existing Systems Only.*
 6-Pin Only - No Cross Keying - Available in Z and DH Class Keyways only.
 Available UC or master keyed only.
 Not available KR or O-bitted.
 * L4, D1 and 60 keyway sections may be ordered Keyed Random only, without prior Key Systems Administration approval

Hotel Function Cylinders

Cylinder Number	Description	605, 606, 611, 612, 613, 613E, 618, 619, 622, 625, 626, 629, 630, 722, BSP, WSP
CR1011-114-A01	1-1/4" Cloverleaf cam only	\$232.00

To simplify ordering, you may specify only "1011" since no length or cam variations exist.
 For uncombined cylinders, suffix "UC". See page 48 for deduct.
 Not available in D1, D2, L1 or L2 keyways.

Security Rim

For Existing Systems Only.*

6-Pin Only - No Cross Keying - Available in Z and DH Class Keyways Only.
Available UC or master keyed only. Not available KR or 0-bitted.

* L4, D1 and 60 keyway sections may be ordered Keyed Random only, without prior Key Systems Administration approval

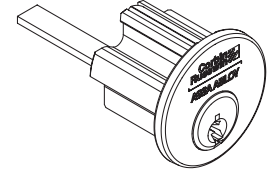

Cylinder Number Example

To simplify ordering, options designated "standard" may be omitted from the ordering sequence.

CR3010 - 200 - L4

Function	Tailpiece Length	Keyway
For 3010 Only:	For 3010 Only:	L4 (standard) Available only with Z and DH Class keyways. See page 61 for pricing of options.
0 (standard)	200 2" (standard)	
	200V 2" vertical	
	312 3-1/2" (thick door)	
	312V 3-1/2" (thick door) vertical	
	058 5/8" Tailpiece	
	138 1-3/8" M61 and M62 option for ED8200 and obsolete ED9200 exit device alarms	
	For 3012 Only:	
	178 1-7/8" (standard)	
	178V 1-7/8" vertical	
	318 3-1/8" (thick door)	
	318V 3-1/8" (thick door) vertical	

Cylinder Number	605, 606, 611, 612, 613, 613E, 618, 619, 622, 625, 626, 629, 630, 722, BSP, WSP
CR3010-058-__	\$214.00
CR3010-200-__	
CR3010-200V-__	
CR3010-312-__	\$216.00
CR3010-312V-__	
CR3010-138-__ No back plate or screws	\$214.00
CR3012-178-__	\$222.00
CR3012-178V-__	
CR3012-318-__	\$224.00
CR3012-318V-__	

Security Key-In-Lever/Knob

For Existing Systems Only.*
6-Pin Only - No Cross Keying - Available in Z and DH Class Keyways Only.
Available UC or master keyed only. Not available KR or 0-bitted.

* L4, D1 and 60 keyway sections may be ordered Keyed Random only, without prior Key Systems Administration approval

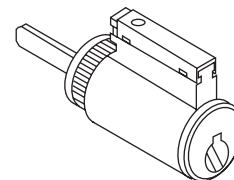

For Key-In-Lever/Knob Trim (.552" plug)

Cylinder Number	Series	Finish: 606, 626
2010-031	CL3100, CK4300	\$205.00
2010-033	CL3300, CL3500, CL3800 ^a , [CL3600 (June 2000 and after)]	
2010-034	CL3400, [CL3600 (prior to June 2000)]	
2010-038	CL3800 ^a	
2010-039	CL3900	
2010-039L	CL3900 (2 - 2-1/4" door)	
2010-052	CK4200, UT5200	
2011-042	CK4229 Hotel Function*	\$219.00
2010-051	B2, G2 Exit Device Knob Trim	\$205.00
4410-134-A51	DL2200, DL3200 Cylindrical Deadlock	\$205.00
4410-134-A52	DL2200, DL3200 Cylindrical Deadlock	\$205.00
4410-214-A52	DL2200, DL3200 Cylindrical Deadlock	\$205.00

For uncombined cylinders suffix "UC" - See page 48 for deduct.

*Not available with 752, 852, or A Class Keyways.

Notes: A CL3800 manf. 1993-1997

B CL3800 manf. 2006 -

For Other Manufacturers' Products (.552" plug)

Cylinder Number	Series	Finish: 606, 626
2210-001-A21	Alarm Lock DL2500 Series	\$209.00
	Arrow® H Series Knobs and Levers	
	Arrow Q Series Levers	
	Sargent® 10 line*	
	Schlage® D Series Levers	
2210-001-A22	Schlage AL and ND Series Levers	
2210-002-A21	Schlage D Series Knobs	
2210-002-A23	Schlage A Series Knobs (ORB, only)	
2210-002-A22	Schlage A Series Knobs (PLY, ect)	
2210-003-A24	Lockwood® H Series Knobs (enlarge knob hole)	
2210-008	Sargent 7, 8, 9 Line (enlarge knob hole)	
2210-054	Yale® 5400, 6200 Knobs only (enlarge knob hole)	

* When ordered with a 30- prefix, this cylinder is accepted without modification to the lever.

IC Mortise

For Existing Systems Only.*
For Construction Core Program, see page 63. For housing only, see page 93.

6-Pin Only - No Cross Keying - Available in Z and DH Class Keyways Only.
Available UC or master keyed only. Not available KR or 0-bitted.

* L4, D1 and 60 keyway sections may be ordered Keyed Random only, without prior Key Systems Administration approval

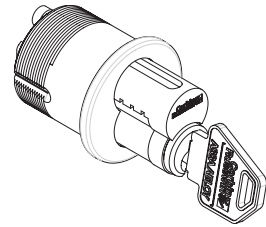

Cylinder Number Example

To simplify ordering, options designated "standard" may be omitted from the ordering sequence.

CR1090 - 114 - A01- L4

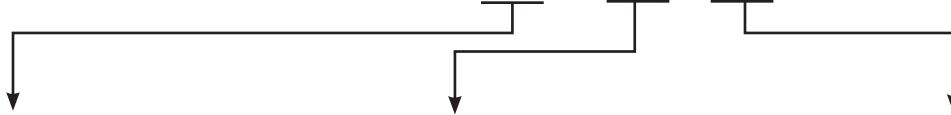

Length	Cam	Keyway
114 1-1/4" (standard)	A01 Cloverleaf (standard)	L4 (standard) Available only with Z and DH Class keyways. See page 61 for pricing of options.
138 1-3/8"	A02 Straight	
112 1-3/8"	A03 Adams Rite® MS & DL3000	
134 1-3/4"	A04 DL4000 Deadlock	
	A05 Adams Rite 4070	
	A06 ² Schlage® L9000	
	A07 DL4100 Series Deadlock	
	A62 Straight	
	A92 Exit Grip 01, 02	
	A93 ¹ For obsolete Corbin® 610 Series and Russwin® 1403 Series Deadlocks	

Cylinder Number	605, 606, 611, 612, 613, 613E, 618, 619, 622, 625, 626, 629, 630, 722, BSP, WSP
CR1090-114-	\$292.00
CR1090-138-	\$295.00
CR1090-112-	
CR1090-134-	\$303.00

- Notes:
1. Add \$2.00 per cylinder for A93 Cam.
2. Add \$5.00 per cylinder for A06 Cam.

Hotel Function IC Mortise

Cylinder Number	605, 606, 611, 612, 613, 613E, 618, 619, 622, 625, 626, 629, 630, 722, BSP, WSP
CR1091-138-A01 Hotel function uses - E1 suffix EMK blank	\$306.00

To simplify ordering, you may specify only "1091" since no length or cam variations exist.

IC Rim

For Existing Systems Only.*
 For Construction Core Program, see page 63.
 For housing only, see page 93.
 6-Pin Only - No Cross Keying - Available in Z and DH Class Keyways Only. Available UC or master keyed only. Not available 0-bitted.
 * L4, D1 and 60 keyway sections may be ordered Keyed Random only, without prior Key Systems Administration approval

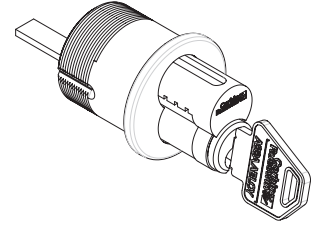

Cylinder Number Example

To simplify ordering, options designated "standard" may be omitted from the ordering sequence.

CR3090 - 178 - L4

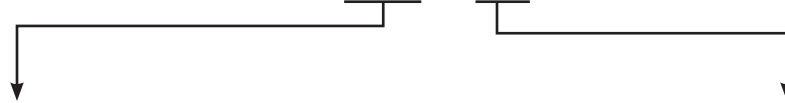

Tailpiece Length		Keyway
058	5/8" Tailpiece	L4 (standard). Available only with Z and DH Class keyways. See page 61 for pricing of options.
178	1-7/8" (standard)	
178V	1-7/8"(standard) vertical	
318	3-1/8" (thick door)	
114	1-1/4" for M61 and M62 option alarmed exit devices	

Cylinder Number	605, 606, 611, 612, 613, 613E, 618, 619, 622, 625, 626, 629, 630, 722, BSP, WSP
CR3090-058	\$292.00
CR3090-178	
CR3090-178V	
CR3090-318	\$294.00
CR3090-114 No back plate or screws	\$294.00

Security Core Only

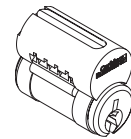

Cylinder Number	605, 606, 611, 612, 613, 613E, 618, 619, 622, 625, 626, 722, BSP, WSP
CR8010 6-pin standard	\$199.00
CR8010EMK 6-pin standard set to hotel mortise EMK	
CR8011-042 6-pin for CK4229, hotel indicator pin	\$213.00

For uncombined cores, suffix "UC," see page 48 for deduct.

Standard Master Ring Mortise

Cylinder Number Example

To simplify ordering, options designated "standard" may be omitted from the ordering sequence.

CR1060 - 118 - A61 - 6 - L4

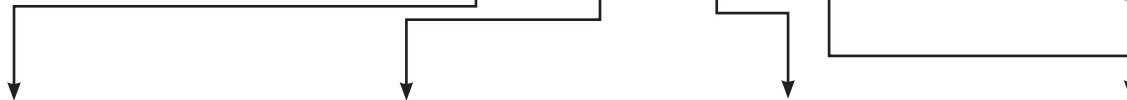

Length	Cam	Pins	Keyway
100 1" (5-pin only)	A61 New Cloverleaf (standard) (for locks made after 5/93; requires thumbturn hub 562F41-2)	5	L4 (standard) See page 61 for pricing of options.
118 1-1/8" (std)	A62 Straight	6 (standard)	
114 1-1/4"	A63* Large Short	7 (optional for 1-3/8" only)	
138 1-3/8"	A64* Large Long		
134 1-3/4"	A65* Old Cloverleaf (formerly 11A)		
112 1-1/2"			
200 2"			
214 2-1/4"			
212 2-1/2"			
234 2-3/4"			
300 3"			

Cylinder Number	605, 606, 611, 612, 613, 613E, 618, 619, 622, 625, 626, 722, BSP, WSP
CR1060-100-__-5	
CR1060-118-__-__	\$144.00
CR1060-114-__-__	
CR1060-138-__-__	
CR1060-112-__-__	\$154.00
CR1060-134-__-__	
CR1060-200-__-__	
CR1060-214-__-__	\$164.00
CR1060-212-__-__	
CR1060-234-__-__	
CR1060-300-__-__	\$164.00

*Add \$2.00 per cylinder for A63, A64 and A65 Cam.

Flexible Head Master Ring Mortise

Cylinder Number Example

To simplify ordering, options designated "standard" may be omitted from the ordering sequence.

CR1160 - 118 - A61 - 6 - L4

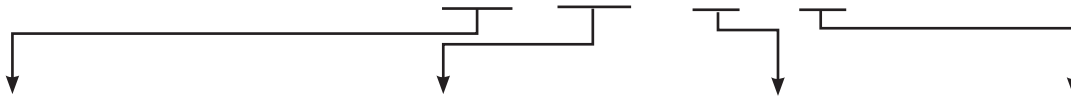

Length	Cam	Pins	Keyway
100 1" (6-pin std)	A61 New Cloverleaf (standard) (for locks made after 5/93; requires thumbturn hub 562F41-2)	5	L4 (standard) See page 61 for pricing of options.
118 1-1/8"		6 (standard)	
114 1-1/4"			
	A62 Straight		
	A63* Large Short		
	A64* Large Long		
	A65* Old Cloverleaf (formerly 11A)		

Cylinder Number	605, 606, 611, 612, 613, 613E, 618, 619, 622, 625, 626, 722, BSP, WSP
CR1160-100-__-__	\$182.00
CR1160-118-__-__	
CR1160-114-__-__	

* Add \$2.00 per cylinder for A63, A64 or A65 Cam.

Dummy Master Ring Mortise Cylinders

Cylinder Number	605, 606, 611, 612, 613, 613E, 618, 619, 622, 625, 626, 722, BSP, WSP
CR1460-118	\$136.00
CR1460-114	
CR1460-138	
CR1460-112	

Master Ring Rim

Cylinder Number (Specify Keyway)	F605, 606, 611, 612, 613, 613E, 618, 619, 622, 625, 626, 722, BSP, WSP
CR3060-200 Standard horizontal tailpiece	\$144.00
CR3060-312 Thick door, horizontal tailpiece	
CR3060-200V Vertical tailpiece	
CR3060-312V Thick door, vertical tailpiece	

For CK4200 & UT5200 Series Locksets (.552" dia. plug)

Cylinder Number	Finish: 606, 626
CR2060-052 Standard	\$121.00
CR2061-042* CK4229 Hotel with indicator pin	\$147.00
CR2160-052** Discontinued Ronde and Continental Knob	\$131.00

* Not Available with 752, 852 or A Class keyways.
 ** Also Available in 605, 611, 612, 613, 625 finishes.
 Not Available with X Class and certain restricted keyways.

Master Ring Special Applications For Exit Device Operators (.552" plug)

Cylinder Number	Finish: 606, 626
CR4266-001-A02 ED6800 x B5 or B6 trim	\$135.00
ED7400 x 03 or 04 trim	
CR4266-001-A92 ED6800 x 01 or 02 trim	

Pin Kits

Description	Catalog Number	Part Number	Price
Corbin Russwin System 70 and Pre-System 70, 752, 852 and A Class keyways Not for System 70 Security	PK-1070	610F538	\$980.00
Corbin® Z Class and Russwin® DH Class keyways System 70, all cylinders except Security	PK-70-ZDH	602F129	\$653.00
Russwin N Class System, all cylinders	PK-70-N	602F119	\$510.00
Corbin X Class, all cylinders	PK-70-X	602F109	\$498.00
Pyramid High Security cylinders	PK-20-HS	694F968	\$1,344.00
Pyramid Security cylinders	PK-20-PS	715F968	\$993.00
Security cylinders, including interchangeable core, blackout and Brink	PK-70-HS	610F529	\$1,852.00
Access 3 Key System AP only	PK-30-AP	763F088	\$955.00
Access 3 Key System - AP, AS, AHS	PK-30-MASTER	763F098	\$1,391.00

Tools

Description	Catalog Number	Part Number	Price
Tool kit - contains 1 each: CT-4, CT-11, CT-19, CT-21, CT-22, CT-23, CT-54	CT-93	612F588	\$319.00
Plug follower, .509" brass	CT-4	073F992	\$31.00
Pin chamber reamer	CT-5	239F758	\$88.00
Pin chamber burring tool	CT-7	382F188	\$233.00
Loading tool for .509" shell	CT-10	577F499	\$88.00
Key gauge, all Corbin® key classes	CT-11	239F377	\$31.00
Tweezers (was CT-6)	CT-19	239F368	\$37.00
Plug follower, .496	CT-20	694F972	\$14 (order in mult.of 10)
Key gauge, Pyramid	CT-20K	698F367	\$31.00
Key gauge, Access 3	CT-30K		
Key gauge, Russwin® N	CT-21	603F277	
Key gauge, Russwin® D & H	CT-22	604F197	
Key gauge, Russwin® 981/852	CT-23	604F187	
Plug follower, .552" brass	CT-54	073F982	\$38.00
IC mortise cylinder installation wrench	CT-80	363F612	\$54.00
Follower, disposable, .509" plug		484F729	\$1.00 (order in mult. Of 50)
Follower, disposable, .552" plug		484F739	\$0.50 (order in mult. Of 100)

Blank Page

Access 800® AC2 Microshield®	72
ML20800 Series:	
ML20800 Standard Features & Ordering Examples	73
ML20800 AC2 Museo Mortise Lockset Series:	
ML20800 AC2 Series: Museo Georgia, Pablo, Jackson, Salvador, Marc, Josef Levers	74
ML20800 AC2 Series: Museo Georges Levers	75
ML20800 AC2 Series: Museo Piet Levers	76
ML20800 Lever Designs Series:	
ML20800 Lever Designs & Options	77
ML20800 Cylinder & Keying Options	78
ML20800 Door Thickness, Strike Options, Miscellaneous Options	79
CL33800 Series:	
CL33800 Standard Features & Ordering Examples	80
CL33800 Lever Designs & Options	81
CL33800 Cylinder & Keying Options	82
CL33800 Door Thickness, Strike Options, Miscellaneous Options	83
ED5000 Series:	
ED5000 Standard Features & Ordering Examples	84
EDS000 Museo Series:	
ED5000 Series: Museo Georgia, Pablo, Jackson, Salvador, Marc, Josef Levers with 900 Series Escutcheon	85
ED5000 Series: Museo Georges Levers with 900 Series Escutcheon	86
ED5000 Series: Museo Piet Levers with 900 Series Escutcheon	87
ED5000 Lever Designs Series:	
ED5200 Series Lever Designs & Options	88
ED5633 & ED5634 Series Lever Designs & Options	89
ED5000 Series Cylinder & Keying Options	90
ED5000 Series Strike, Door Thickness, Width, Miscellaneous Options	91
ED5000 Series Electrified Options, Delayed Egress Options, Accessories	92
WM800 Reader/Controller	93
Wiring Diagram Services & Accessories:	
Custom Wiring, Keypads, Controllers, Software	94
Credentials, Hardware, Gaskets, Accessories	95
Blank Page	96



Look for the 
MicroShield icon.

MicroShield®

As part of their promise to provide innovative solutions to their customers, certain ASSA ABLOY Group brands offer the MicroShield® technology, a silver-based antimicrobial coating designed to inhibit the growth of bacteria.

MicroShield® is a registered trademark of Yale Security Inc., an ASSA ABLOY Group company.

Product	Series	MicroShield® Coated Components
Access 800®	All	Levers* and escutcheons

AVAILABLE FINISHES

- MicroShield® is available on 626 and 630. Other finishes available by Special Product Application Request Form only.
- Specify 626C (satin chrome plated) or 630C (satin stainless steel) when ordering.
- MicroShield® coating will be applied over 626 and 630 finishes.
All components will match 626.

Note: MicroShield® coating will only be applied to "high touch" components.

Description	Add
Mortise Locks	Add \$69.00
Cylindrical Locks	Add \$69.00
Exit Devices & Outside Trims (ordered together)	Add \$86.00 (when ordered together)
Exit Devices & Trims (ordered separately)	Add \$69.00

**ML20800 Mortise
Standard Features**

Handing

Handed; quick reversible

Door Thickness

1-3/4"

Backset

2-3/4" Standard

Strike

ANSI straight lip
4-7/8" x 1-1/4" x 1-1/8"

Cylinder

1000-138-A01, 6-pin, L4, keyed random,
finished standard for 1-3/4" door

Keys

Two nickel silver standard

Weight 11 lbs

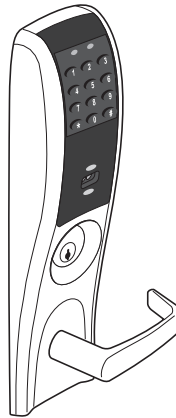

ML20800 Mortise Lock Ordering Examples

Stock Order

Quantity	Series/Function	Technology Code	Trim	Finish	Hand	Credential Quick Code
24	ML20834	TCAC2	LSZ	626	RHR	M803

Split Trim/Finish Order

Quantity	Series/Function	Technology Code	Trim		Finish		Hand	Credential Quick Code
			Outside	Inside	Outside	Inside		
24	ML20834	TCAC2	LSZ	CSZ	626	606	RHR	M803

Contract/Detailed Order

Quantity	Keypad	Series/Function	Technology Code	Trim	Finish	Hand	Door Thickness	Optional Strike	Credential Quick Code	Optional Cylinder	Keying
24	AA1	ML20834	TCAC2	LSZ	626	RHR	D214	SA200	M803	C7	VKC3

Access 800® AC2 Mortise Locksets

ML20800 Series: Muséo Levers

USA & Canada Prices Effective March 16, 2020



contemporary levers to complement the interior design of your next project

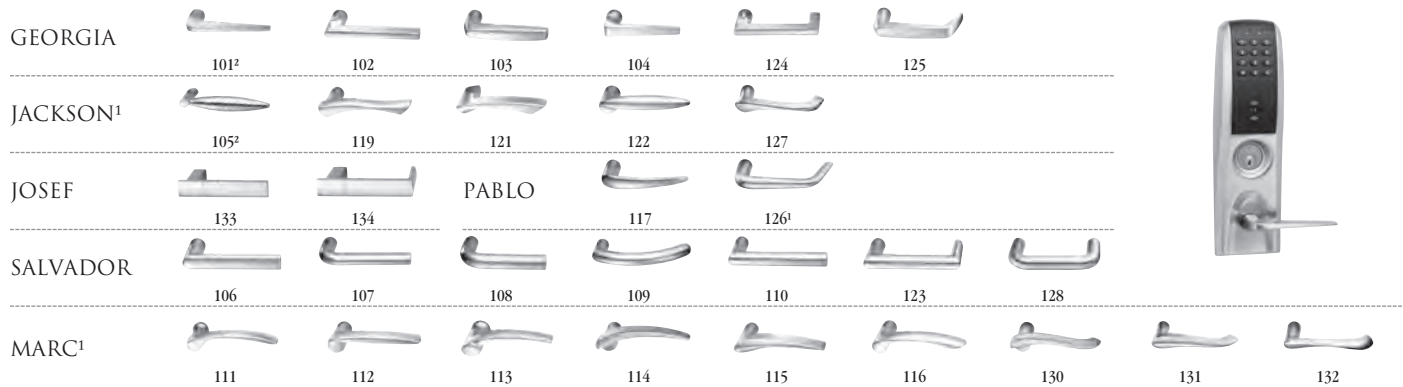

1. Handed: specify hand when ordering.
2. Contact factory for current lead time.

*629 and *630 finish options are Not available for all Muséo levers. Please refer to page 20 for availability.

613E	Dark Oxidized Satin Bronze - Equivalent	605	Bright Brass, Clear Coated	618	Bright Nickel Plated
626	Satin Chromium Plated	606	Satin Brass, Clear Coated	619	Satin Nickel Plated
BSP	Black Suede Powder Coat	611	Bright Bronze, Clear Coated	625	Bright Chromium Plated
WSP	White Suede Powder Coat	612	Satin Bronze, Clear Coated	629*	Bright Stainless Steel
		613	Dark Oxidized Satin Bronze, Oil Rubbed	630*	Satin Stainless Steel
		613L	Dark Oxidized Satin Bronze, Clear Coated	722	Black Oxidized Bronze, Oil Rubbed

Function	Description		
Levers: Georgia, Pablo, Jackson, Salvador, Marc			
ML20833	Without key override x M800	\$1,292.00	\$1,394.00
ML20834	With key override x M800	\$1,385.00	\$1,487.00
ML20835	Deadbolt without key override x M800	\$1,306.00	\$1,408.00
ML20836	Deadbolt with key override x M800	\$1,399.00	\$1,501.00
ML20837*	Dormitory Entry with Deadbolt and inside lever switch x M802	\$1,986.00	\$2,088.00
	Dormitory Entry with Deadbolt and inside lever switch x M803	\$2,051.00	\$2,153.00

*ML20837 only compatible with proximity readers, M802 and M803

Access 800® Options			
Description	Specify Quick Code	Add	
100 User, keypad only	M800	No Charge	
2000 User, keypad only	M801	\$155.00	
2000 User, proximity only	M802	\$587.00	
2000 User, keypad and proximity	M803	\$652.00	
2000 User, keypad and RF actuation	M804	\$369.00	
2000 User, proximity and RF actuation	M805	\$801.00	
2000 User, keypad, proximity and RF actuation	M806	\$865.00	
Gasket	M99	No Charge	



ASSA ABLOY

BHMA CERTIFIED ML20800

Ordering Example Details →

ML20834	Key Override
114	Marc Family Lever
619	Finish
RHR	Handing

Stock Order							
Quantity	Series/Function	Technology Code	Trim	Finish	Hand	Option	
24	ML20834	TCAC2	114Z	619	RHR	M801	

Access 800® AC2 Mortise Locksets

ML20800 Series: Muséo Levers

USA & Canada Prices Effective March 16, 2020



contemporary levers to complement the interior design of your next project

GEORGES



1. Handed: specify hand when ordering
2. Contact factory for current lead time

613E	Dark Oxidized Satin Bronze - Equivalent
626	Satin Chromium Plated
BSP	Black Suede Powder Coat

605	Bright Brass, Clear Coated	618	Bright Nickel Plated
606	Satin Brass, Clear Coated	619	Satin Nickel Plated
611	Bright Bronze, Clear Coated	625	Bright Chromium Plated
612	Satin Bronze, Clear Coated	629	Bright Stainless Steel
613	Dark Oxidized Satin Bronze, Oil Rubbed	630	Satin Stainless Steel
613L	Dark Oxidized Satin Bronze, Clear Coated	722	Black Oxidized Bronze, Oil Rubbed

Function	Description		
Levers: Georgia, Pablo, Jackson, Salvador, Marc			
ML20833	Without key override x M800	\$1,370.00	\$1,394.00
ML20834	With key override x M800	\$1,463.00	\$1,487.00
ML20835	Deadbolt without key override x M800	\$1,384.00	\$1,408.00
ML20836	Deadbolt with key override x M800	\$1,477.00	\$1,501.00
ML20837*	Dormitory Entry with Deadbolt and inside lever switch x M802	\$2,064.00	\$2,088.00
	Dormitory Entry with Deadbolt and inside lever switch x M803	\$2,129.00	\$2,153.00

*ML20837 only compatible with proximity readers, M802 and M803

Access 800® Options

Description	Specify Quick Code	Add
100 User, keypad only	M800	No Charge
2000 User, keypad only	M801	\$155.00
2000 User, proximity only	M802	\$587.00
2000 User, keypad and proximity	M803	\$652.00
2000 User, keypad and RF actuation	M804	\$369.00
2000 User, proximity and RF actuation	M805	\$801.00
2000 User, keypad, proximity and RF actuation	M806	\$865.00
Gasket	M99	No Charge



Ordering Example Details

ML20800	ML20834	Key Override
	133	Josef Family Lever
	619	Finish
	RHR	Handing

Stock Order							
Quantity	Series/Function	Technology Code	Trim	Finish	Hand	Option	
24	ML20834	TCAC2	133Z	619	RHR	M801	

Experience a safer and more open world

Access 800® AC2 Mortise Locksets

ML20800 Series: Muséo Levers

USA & Canada Prices Effective March 16, 2020

contemporary levers to complement the interior design of your next project

MUSÉO®

PIET



*613E, BSP, WSP finishes are not available with 21M levers.



613E	Dark Oxidized Satin Bronze – Equivalent
629	Bright Stainless Steel
630	Satin Stainless Steel
BSP	Black Suede Powder Coat
WSP	White Suede Powder Coat

Function Description

Levers: Piet

ML20833	Without key override x M800	\$1,394.00
ML20834	With key override x M800	\$1,487.00
ML20835	Deadbolt without key override x M800	\$1,408.00
ML20836	Deadbolt with key override x M800	\$1,501.00
ML20837 ¹	Dormitory Entry with Deadbolt and inside lever switch x M802	\$2,088.00
	Dormitory Entry with Deadbolt and inside lever switch x M803	\$2,153.00

Access 800® Options

Description	Specify Quick Code	Add
100 User, keypad only	M800	No Charge
2000 User, keypad only	M801	\$155.00
2000 User, proximity only	M802	\$587.00
2000 User, keypad and proximity	M803	\$652.00
2000 User, keypad and RF actuation	M804	\$369.00
2000 User, proximity and RF actuation	M805	\$801.00
2000 User, keypad, proximity and RF actuation	M806	\$865.00



Ordering Example Details

ML20800

ML20834	Key Override
21MZ	Piet Family Lever - Polished with Satin Insert
293029	Lever Finish
	Polished with satin stainless steel insert (630), polished stainless steel (629) shank and polished stainless steel (629) grip
625	Lock Finish
RHR	Handing

Stock Order

Quantity	Series/Function	Technology Code	Trim	Lever Finish	Lock ² Finish	Hand	Option
2	ML20834	TCAC2	21MZ	293029	625	RHR	M801

¹ML20837 only compatible with proximity readers, M802 and M803

²Escutcheons (lock finish) are plated to match satin stainless steel (630) and polished stainless steel (629) finishes.



Experience a safer and more open world

Lever Design: ASZ, CSZ, DSZ, ESZ, LSZ, NSZ, PSZ, RSZ

Lever: Cast **Escutcheon:** Zinc Die Cast

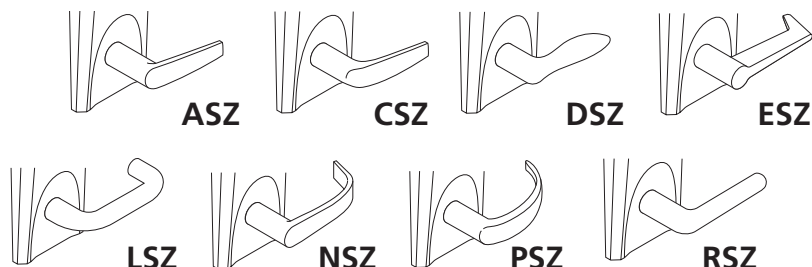

Lever Design: FSZ, MSZ, ZSZ

Lever: Cast **Escutcheon:** Zinc Die Cast



Function	Description	ASZ, CSZ, DSZ, ESZ, LSZ, NSZ, PSZ, RSZ		FSZ, MSZ, ZSZ	
		Finish: 613E, 626, BSP, WSP	Finish: 605, 606, 611, 612, 613, 613L, 618, 619, 625, 630, 722	Finish: 613E, 626, BSP, WSP	Finish: 605, 606, 611, 612, 613, 613L, 618, 619, 625, 722
ML20833	Without key override x M800	\$1,292.00	\$1,394.00	\$1,292.00	\$1,394.00
ML20834	With key override x M800	\$1,385.00	\$1,487.00	\$1,385.00	\$1,487.00
ML20835	Deadbolt without key override x M800	\$1,306.00	\$1,408.00	\$1,306.00	\$1,408.00
ML20836	Deadbolt with key override x M800	\$1,399.00	\$1,501.00	\$1,399.00	\$1,501.00
ML20837*	Dormitory Entry with Deadbolt and inside leverswitch x M802	\$1,986.00	\$2,088.00	\$1,986.00	\$2,088.00
	Dormitory Entry with Deadbolt and inside leverswitch x M803	\$2,051.00	\$2,153.00	\$2,051.00	\$2,153.00

Access 800® Options

Description	Specify	Add
100 User, keypad only	M800	No Charge
2000 User, keypad only	M801	\$155.00
2000 User, proximity only	M802	\$587.00
2000 User, keypad and proximity	M803	\$652.00
2000 User, keypad and RF actuation**	M804	\$369.00
2000 User, proximity and RF actuation**	M805	\$801.00
2000 User, keypad, proximity and RF actuation**	M806	\$865.00

* ML20837 only compatible with proximity readers, M802 and M803

** Note: RF Fob must be ordered separately. See page 104.

Mortise Lockset ML20800 Series Cylinder Options

For Key Override function only

Description	Specify	Add or Deduct
Conventional 6-pin	(standard)	No Charge
Conventional 7-pin	7P	Add \$2.00 per cylinder
Less Standard Cylinder	LC	Deduct \$93.00 per cylinder
Access 3 Patented	AP	No Charge
Access 3 Security	AS	Add \$61.00 per cylinder
Access 3 High Security, UL 437	AHS	Add \$86.00 per cylinder
Access 3 IC Patented	ACP	Add \$80.00 per cylinder
Access 3 IC Security	ACS	Add \$132.00 per cylinder
Access 3 IC High Security, UL 437	ACHS	Add \$153.00 per cylinder
Pyramid Security Fixed Core	PS	Add \$64.00 per cylinder
Pyramid Security IC	PCS	Add \$140.00 per cylinder
Pyramid High Security Fixed Core	PHS	Add \$96.00 per cylinder
Pyramid High Security IC	PCHS	Add \$171.00 per cylinder
Pyramid IC with Temporary Construction Core	CTP	Add \$80.00 per cylinder
Pyramid IC with Temporary Disposable Core	CTPD	No Charge
Pyramid IC Less Core	CLP	No Charge
Security	HS	Add \$121.00 per cylinder
Security IC	CHS	Add \$199.00 per cylinder
IC 6-pin	C6	Add \$80.00 per cylinder
IC 6-pin with Temporary Construction Core (Red)	CT6R	Add \$80.00 per cylinder
IC 6-pin with Temporary Construction Core (Blue)	CT6B	Add \$80.00 per cylinder
IC 6-pin with Temporary Construction Core (Green)	CT6G	Add \$80.00 per cylinder
IC 6-pin with Temporary Disposable Core	CT6D	No Charge
IC 6-pin Less Core	CL6	No Charge
SFIC 6-pin with Less Core	CLS6	No Charge
IC 6-pin with SFIC disposable temporary core	CT6SD	No Charge
IC 7-pin	C7	Add \$82.00 per cylinder
IC 7-pin with Temporary Construction Core (Red)	CT7R	Add \$82.00 per cylinder
IC 7-pin with Temporary Construction Core (Blue)	CT7B	Add \$82.00 per cylinder
IC 7-pin with Temporary Construction Core (Green)	CT7G	Add \$82.00 per cylinder
IC 7-pin with Temporary Disposable Core	CT7D	Add \$2.00 per cylinder
IC 7-pin Less Core	CL7	Add \$2.00 per cylinder
SFIC 7-pin with Less Core	CLS7	Add \$2.00 per cylinder
IC 7-pin with SFIC disposable temporary core	CT7SD	Add \$2.00 per cylinder

Keying Options*

Description	Specify	Add or Deduct
0-Bitted with 2 blank keys	(standard)	No Charge
Keyed random	KR	No Charge
Construction master keyed ^{1,2}	CMK	Add \$16.00 per cylinder
Visual key control (VKC)		
- No Stamping	VKC0	\$4.50
- Keys only	VKC1	No Charge
- Cylinders and Keys ³	VKC2	\$8.00
- Cylinders only ³	VKC3	\$8.00
Concealed key control (CKC)		
- CKC cylinders with VKC keys	CKC2	\$8.00
- CKC cylinders only ³	CKC3	\$8.00
More than 2 keys per lock	KY# (e.g., KY6)	See page 31 - Cut Keys Section

*For key bows other than 10 and 90, specify "KB" + bow number as Quick Code, e.g. KB12.

- Notes:
1. CMK Construction master keying charge is in addition to master keying charge.
 2. CMK Construction master keying is not available in interchangeable core, Access 3, Pyramid, or Security series.
 3. VKC2, VKC3, CKC3 are not available in Pyramid or Security series.

Door Thickness

Description	Specify	Add or Deduct
1-3/4"	(standard)	No Charge
2"	D200	
2-1/4"	D214	

Strike Options*

(To purchase strike separately, see catalog or parts manual for part no.)

Lip Length	ANSI Straight Lip - Specify	ANSI Curved Lip - Specify	Add or Deduct
7/8"	SS078	N/A	No Charge
1-1/8"	(standard)	N/A	
1-1/4"	SS114	SA114	
1-3/8"	SS138	SA138	
1-1/2"	SS112	SA112	
1-3/4"	SS134	SA134	Add \$17.00 per lockset
2"	SS200	SA200	
2-1/4"	SS214	SA214	
2-1/2"	SS212	SA212	
2-3/4"	SS234	SS234	
3"	SS300	SA300	

Description	Door Thickness	Specify	Add or Deduct
Open Back Strike	1-3/4"	SB134	Add \$86.00 per lockset
Open Back Strike	2"	SB200	Add \$130.00 per lockset
Open Back Strike	2-1/4"	SB214	
Rabbeted front and strike		SR118	Add \$90.00 per lockset

* If door thickness is standard or has been specified and no special door or frame condition exists, then only the first two characters of the optional strike Quick Code must be specified (e.g. "SA").

The correct lip length will be determined by our order entry system based on the standard or specified door thickness.

Miscellaneous Options

Description	Specify	Add or Deduct
Torx® head screws	M04	Add \$26.00 per lockset
ANSI wrought strike box	M17	No Charge
Knurling outside and inside ¹	M20	Add \$148.00 per lockset
Knurling outside only ¹	M21	Add \$75.00 per lockset
Knurling inside only	M22	Add \$75.00 per lockset
Abrasive coat outside and inside ¹	M23	Add \$92.00 per lockset
Abrasive coat inside only ¹	M24	Add \$47.00 per lockset
Abrasive coat outside only	M25	Add \$47.00 per lockset
Power/Remote Unlocking Harness	M35	Add \$52.00 per lockset
Forced/Propped Door ²	M861	Add \$13.50 per lockset

Notes:

1. Not available with Vineyard™ or Muséo® levers.
2. Not compatible with M800

**CL33800 Cylindrical
Standard Features**

Handing

Non-handed

Door Thickness

1-3/4" - 2"

Backset

2-3/4" Standard

Strike

ANSI curved lip

4-7/8" x 1-1/4" x 1-1/4"

Cylinder

6-pin, L4, keyed random,
0-bitted standard

Keys

Two nickel silver standard

Weight

9.5 lbs

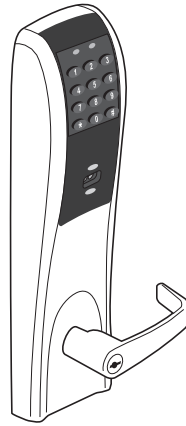

CL33800 Cylindrical Lock Ordering Examples

Stock Order

Quantity	Series/ Function	Technology Code	Trim	Finish	Hand	Credential Quick Code
100	CL33834	TCAC2	NZZ	626	RHR	M803

Split Trim/Finish Order

Quantity	Series/ Function	Technology Code	Trim		Finish		Hand	Credential Quick Code
			Outside	Inside	Outside	Inside		
12	CL33834	TCAC2	NZZ	AZZ	626	625	LH	M803

Contract/Detailed Order

Quantity	Keypad	Series/ Function	Technology Code	Trim	Finish	Hand	Door Thickness	Backset	Optional Strike	Credential Quick Code	Optional Cylinder	Keying
24	AA1	CL33834	TCAC2	NZZ	626	RHR	D214	B334	SC114	M802	C6	VKC3

Lever Design: AZZ, NZZ, PZZ

Lever: Zinc Die Cast

Escutcheon: Zinc Die Cast

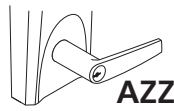

AZZ

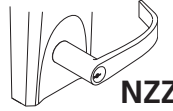

NZZ



PZZ



FZZ

Function	Description	AZZ, NZZ, PZZ, FZZ	
		Finish: 613E, 626, BSP	Finish: 611, 605, 606, 612, 613, 613L, 618, 619, 625, 722
CL33834	With key override x M800	\$1,248.00	\$1,343.00

Access 800® Options

Description	Specify	Add
100 User, keypad only	M800	No Charge
2000 User, keypad only	M801	\$155.00
2000 User, proximity only	M802	\$587.00
2000 User, keypad and proximity	M803	\$652.00
2000 User, keypad and RF actuation*	M804	\$369.00
2000 User, proximity and RF actuation*	M805	\$801.00
2000 User, keypad, proximity and RF actuation*	M806	\$865.00

* Note: RF Fob must be ordered separately. See page 104.

Cylindrical Lockset CL33800 Series Cylinder Options

Description	Specify	Add or Deduct
Conventional 6-pin	(standard)	No Charge
Conventional 7-pin	7P	Add \$2.00 per cylinder
Less Standard Cylinder	LC	Deduct \$93.00 per cylinder
Access 3 Patented	AP	No Charge
Access 3 Security	AS	Add \$61.00 per cylinder
Access 3 High Security, UL 437	AHS	Add \$86.00 per cylinder
Access 3 IC Patented	ACP	Add \$80.00 per cylinder
Access 3 IC Security	ACS	Add \$132.00 per cylinder
Access 3 IC High Security, UL 437	ACHS	Add \$153.00 per cylinder
Pyramid Security Fixed Core	PS	Add \$64.00 per cylinder
Pyramid Security IC	PCS	Add \$140.00 per cylinder
Pyramid High Security Fixed Core	PHS	Add \$94.00 per cylinder
Pyramid High Security IC	PCHS	Add \$171.00 per cylinder
Pyramid IC Less Core	CLP	No Charge
Security	HS	Add \$119.00 per cylinder
Security IC	CHS	Add \$199.00 per cylinder
IC 6-pin	C6	Add \$80.00 per cylinder
IC 6-pin with Temporary Construction Core (Red)	CT6R	Add \$80.00 per cylinder
IC 6-pin with Temporary Construction Core (Blue)	CT6B	Add \$80.00 per cylinder
IC 6-pin with Temporary Construction Core (Green)	CT6G	Add \$80.00 per cylinder
IC 6-pin with Temporary Disposable Core	CT6D	No Charge
IC 6-pin Small Format Disposable Core	CTSD	No Charge
IC 6-pin Less Core	CL6	No Charge
IC 7-pin	C7	Add \$82.00 per cylinder
IC 7-pin with Temporary Construction Core (Red)	CT7R	Add \$82.00 per cylinder
IC 7-pin with Temporary Construction Core (Blue)	CT7B	Add \$82.00 per cylinder
IC 7-pin with Temporary Construction Core (Green)	CT7G	Add \$82.00 per cylinder
IC 7-pin with Temporary Disposable Core	CT7D	No Charge
IC 7-pin Less Core	CL7	No Charge
Lockset furnished in Schlage® C Keyway ¹	C	No Charge
Lockset furnished in SARGENT® LA Keyway ²	LA	No Charge

Keying Options*

Description	Specify	Add or Deduct
0-Bitted with 2 blank keys	(standard)	No Charge
Keyed random	KR	No Charge
Construction master keyed ^{1, 2}	CMK	Add \$16.00 per cylinder
Visual key control (VKC)		
- No Stamping	VKC0	\$4.50
- Keys only	VKC1	No Charge
- Cylinders and Keys ³	VKC2	\$8.00
- Cylinders only ³	VKC3	\$8.00
Concealed key control (CKC)		
- CKC cylinders with VKC keys	CKC2	\$8.00
- CKC cylinders only ³	CKC3	\$8.00
More than 2 keys per lock	KY# (e.g., KY6)	See page 31 - Cut Keys Section

*For key bows other than 10 and 90, specify "KB" + bow number as Quick Code, e.g. KB12.

Notes:

1. CMK Construction master keying charge is in addition to master keying charge.
2. CMK Construction master keying is not available in interchangeable core, Access 3, Pyramid, or Security series.
3. VKC2, VKC3, CKC3 are not available in Pyramid or Security series.

Door Thickness Options

Description	Specify	Add or Deduct
1-3/4"	(standard)	
2"	D214	Add \$7.50 per lockset

Backset Options

Description	Specify	Add or Deduct
2-3/4"	(standard)	No Charge
3-3/4"	B334	Add \$15.00 to lockset
5"	B500	Add \$24.00 to lockset

Strike Options*

(To purchase strike separately, see catalog or parts manual for part no.)

Lip Length	ANSI Straight Lip - Specify	ANSI Curved Lip - Specify	Add or Deduct
1"	SA100	SC100	No Charge
1-1/8"	SA118	SC118	
1-1/4"	(standard)	SC114	
1-3/8"	SA138	SC138	
1-1/2"	SA112	SC112	
1-3/4"	SA134	SC134	Add \$17.00 per lockset
2"	SA200	SC200	
2-1/4"	SA214	SC214	
2-1/2"	SA212	SC212	
2-3/4"	SA234	SC234	
3"	SA300	SC300	Add \$90.00 per lockset
Rabbeted front and strike		SR118	

*If door thickness is standard or has been specified and no special door or frame condition exists, then only the first two characters of the optional strike Quick Code must be specified (e.g. "SC").

The correct lip length will be determined by our order entry system based on the standard or specified door thickness.

Miscellaneous Options

Description	Specify	Add or Deduct
Torx® head screws	M04	Add \$26.00 per lockset
Less cylinder, with tailpiece for Schlage® cylinder	M06	No Charge
Lever to accept Best® type core (NZZ & PZZ designs only)	M08	No Charge
Lever to accept Sargent® cylinder (NZZ & PZZ design only)	M09	No Charge
Rounded corners on latch front	M13	Add \$2.50 per latch
3/4" (19mm) throw fire latch	M16	Add \$100.00 per lockset
ANSI wrought strike box	M17	No Charge
Knurling outside and inside	M20	Add \$148.00 per lockset
Knurling outside only	M21	Add \$75.00 per lockset
Knurling inside only	M22	Add \$75.00 per lockset
Abrasive coat outside and inside	M23	Add \$92.00 per lockset
Abrasive coat inside only	M24	Add \$47.00 per lockset
Abrasive coat outside only	M25	Add \$47.00 per lockset
Power/Remote Unlocking Harness	M35	Add \$52.00 per lockset
Lever to accept Schlage® interchangeable core (NZZ & PZZ design only)	M69	No Charge
Forced door/propped door ²	M861	Add \$13.50 per lockset

Notes: 2. Not compatible with M800

ED5000 Exit Devices

Standard Features

Handing

Device non-handed; lever trim is handed

Door Thickness

1-3/4" Standard

Stile

4-1/2" Minimum width

Strike

Rim Device: Surface mounted 3/8" diameter roller strike

Mortise Device: ANSI curved lip strike

Projection

3-1/4" active, 2-3/4" dogged

Trim

Cylinder is not included. See page 117 for Cylinder options.

Weight

8.5 lbs



ED5000 Series Exit Devices Ordering Examples

Exit Device Only

Quantity	Series/Function	Finish	Hand	Misc. Options
24	ED5200S	626	RHR	M51-M54

Trim Only

Quantity	Trim/Function	Technology Code	Finish	Hand	Credential Quick Code
24	N9M833ET	TCAC2	625	RHR	M800

Exit Device with Trim

Quantity	Exit Device	Trim/Function	Technology Code	Finish	Hand	Cylinder Option	Door Thickness	Optional Strike	Door Width	Misc. Options	Credential Quick Code
65	ED5634L	N9M834ET	TCAC2	605	LHR	6P	D200	SB134	W048	M51-M54 & M800	M800

Contract/Detailed Order - Rim Exit Device with Trim

Quantity	Keyset	Exit Device	Trim/Function	Technology Code	Finish	Hand	Door Width	Credential Quick Code	Cylinder Option
36	AA1	ED5200	C9M834ET	TCAC2	626	LHR	W048	M804	79

Removable Mullion

Quantity	Mullion	Misc. Options
24	CR908A	M57

Mortise Exit Only

Trim Type	Function	Panic	Fire
Lever	Entry without key override	ED5600L	ED5600AL
Lever	Entry with key override	ED5634L	ED5634AL

Access 800® AC2 Exit Devices

ED5000 Series: Muséo Levers

USA & Canada Prices Effective March 16, 2020



contemporary levers to complement the interior design of your next project

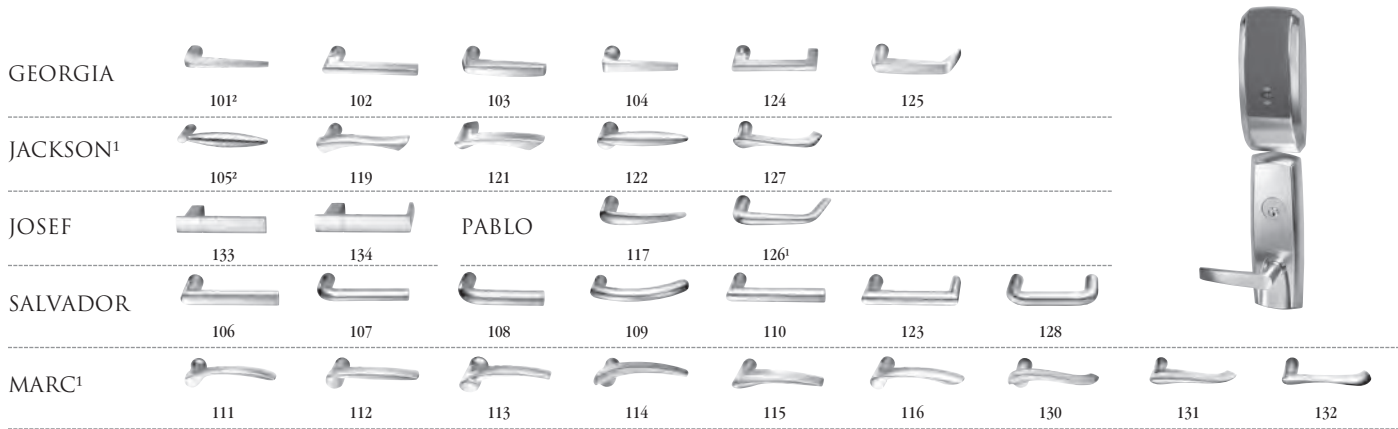

1. Handed: specify hand when ordering.
2. Contact factory for current lead time.

*629 and *630 finish options are Not available for all Muséo levers. Please refer to page 20 for availability.

Levers: Georgia, Pablo, Jackson, Salvador, Marc

Function	Description
Use with ED5200(S)(A) Rim/SecureBolt® Device	

605	Bright Brass, Clear Coated	613L	Dark Oxidized Satin Bronze, Clear Coated	WSP	White Suede Powder Coat
606	Satin Brass, Clear Coated	618	Bright Nickel Plated	722	Black Oxidized Bronze, Oil Rubbed
611	Bright Bronze, Clear Coated	619	Satin Nickel Plated		
612	Satin Bronze, Clear Coated	625	Bright Chromium Plated		
613	Dark Oxidized Satin Bronze, Oil Rubbed	629*	Bright Stainless Steel		
613E	Dark Oxidized Satin Bronze - Equivalent	630*	Satin Stainless Steel		
		BSP	Black Suede Powder Coat		

9833	Without key override x M800	\$1,392.00	Note: For key override, add Cylinder Quick Code Option and price. *When specifying function, prefix with lever design. Refer to page 224 for mechanical push bar pricing.
9834	With key override x M800		
Use with ED5633(A)L & ED5634(A)L Mortise Device			Note: For key override, add Cylinder Quick Code Option and price. See page 93. *When specifying function, prefix with lever design. Refer to page 224 for mechanical push bar pricing.
9M833	Without key override x M800	\$1,344.00	
9M834	With key override x M800		

Note: 9M833 and 9M834 cannot be retrofitted to an existing ED5000 Series mortise device. When ordered as "Trim Only" 9M833 and 9M834 will be furnished with the appropriate mortise lock (refer to Parts Price List for mortise lock body pricing). If a "Trim Only" order is intended for retrofitting and exit device with an M91 Bolt Monitor or an M93 Trim Monitor function, that function must be specified with the trim order to ensure the correct lock is furnished.

Access 800® Options

Description	Specify Quick Code	Add
100 User, keypad only	M800	No Charge
2000 User, keypad only	M801	\$155.00
2000 User, proximity only	M802	\$587.00
2000 User, keypad and proximity	M803	\$652.00
2000 User, keypad and RF actuation	M804	\$369.00
2000 User, proximity and RF actuation	M805	\$801.00
2000 User, keypad, proximity and RF actuation	M806	\$865.00
Gasket	M99	No Charge

- Notes:
1. Available 0-bitted and Key Random (KR) only.
 2. Available 0-bitted only.



Ordering Example Details
ED5000 Series

112
9M833 Marc Family Lever Mortise without key override function

Trim Only					
Quantity	Trim/Function	Technology Code	Finish	Hand	Options
24	1129M833	TCAC2	625	RHR	M800



Experience a safer and more open world

Access 800® AC2 Exit Devices

ED5000 Series: Muséo Levers

USA & Canada Prices Effective March 16, 2020

contemporary levers to complement the interior design of your next project



GEORGES



1. Handed: specify hand when ordering
2. Contact factory for current lead time

Levers: Georgia, Pablo, Jackson, Salvador, Marc

605	Bright Brass, Clear Coated	613L	Dark Oxidized Satin Bronze, Clear Coated	WSP	White Suede Powder Coat
606	Satin Brass, Clear Coated	618	Bright Nickel Plated	722	Black Oxidized Bronze, Oil Rubbed
611	Bright Bronze, Clear Coated	619	Satin Nickel Plated		
612	Satin Bronze, Clear Coated	625	Bright Chromium Plated		
613	Dark Oxidized Satin Bronze, Oil Rubbed	629*	Bright Stainless Steel		
613E	Dark Oxidized Satin Bronze - Equivalent	630*	Satin Stainless Steel		
		BSP	Black Suede Powder Coat		

Function	Description		
Use with ED5200(S)(A) Rim/SecureBolt® Device			
9833	Without key override x M800	\$1,422.00	Note: For key override, add Cylinder Quick Code Option and price. *When specifying function, prefix with lever design. Refer to page 224 for mechanical push bar pricing.
9834	With key override x M800		
Use with ED5633(A)L & ED5634(A)L Mortise Device			
9M833	Without key override x M800	\$1,374.00	Note: For key override, add Cylinder Quick Code Option and price. See page 93. *When specifying function, prefix with lever design. Refer to page 224 for mechanical push bar pricing.
9M834	With key override x M800		

Note: 9M833 and 9M834 cannot be retrofitted to an existing ED5000 Series mortise device. When ordered as "Trim Only" 9M833 and 9M834 will be furnished with the appropriate mortise lock (refer to Parts Price List for mortise lock body pricing). If a "Trim Only" order is intended for retrofitting and exit device with an M91 Bolt Monitor or an M93 Trim Monitor function, that function must be specified with the trim order to ensure the correct lock is furnished.

Access 800® Options

Description	Specify Quick Code	Add
100 User, keypad only	M800	No Charge
2000 User, keypad only	M801	\$155.00
2000 User, proximity only	M802	\$587.00
2000 User, keypad and proximity	M803	\$652.00
2000 User, keypad and RF actuation	M804	\$369.00
2000 User, proximity and RF actuation	M805	\$801.00
2000 User, keypad, proximity and RF actuation	M806	\$865.00
Gasket	M99	No Charge

Notes:

1. Available 0-bitted and Key Random (KR) only.
2. Available 0-bitted only.



Ordering Example Details

ED5000 Series

133
9M833

Josef Family Lever
Mortise without key
override function

Trim Only

Quantity	Trim/Function	Technology Code	Finish	Hand	Options
24	1339M833	TCAC2	625	RHR	M800



Experience a safer
and more open world

Access 800® AC2 Exit Devices

ED5000 Series: Muséo Levers

USA & Canada Prices Effective March 16, 2020

contemporary levers to complement the interior design of your next project



PIET



*613E, BSP, WSP finishes are not available with 21M levers.



Function Description

Use with ED5200(S)(A) Rim/SecureBolt® Device

9833	Without key override x M800
9834	With key override x M800

613E	Dark Oxidized Satin Bronze – Equivalent
629	Bright Stainless Steel
630	Satin Stainless Steel
BSP	Black Suede Powder Coat
WSP	White Suede Powder Coat

Use with ED5633(A)L & ED5634(A)L Mortise Device

9M833	Without key override x M800
9M834	With key override x M800

		\$1,422.00
		\$1,374.00

Note: 9M833 and 9M834 cannot be retrofitted to an existing ED5000 Series mortise device. When ordered as "Trim Only" 9M833 and 9M834 will be furnished with the appropriate mortise lock (refer to Parts Price List for mortise lock body pricing). If a "Trim Only" order is intended for retrofitting and exit device with an M91 Bolt Monitor or an M93 Trim Monitor function, that function must be specified with the trim order to ensure the correct lock is furnished.

Access 800® Options

Description	Specify Quick Code	Add
100 User, keypad only	M800	No Charge
2000 User, keypad only	M801	\$155.00
2000 User, proximity only	M802	\$587.00
2000 User, keypad and proximity	M803	\$652.00
2000 User, keypad and RF actuation	M804	\$369.00
2000 User, proximity and RF actuation	M805	\$801.00
2000 User, keypad, proximity and RF actuation	M806	\$865.00
Gasket	M99	No Charge

- Notes:
1. Available 0-bitted and Key Random (KR) only.
 2. Available 0-bitted only.



Ordering Example Details

ED5000 Series

23M	Piet Family Lever - Wood Insert
9M833	Mortise without key override function
29BH29	Lever Finish Wood insert with polished stainless steel (629) shank and polished stainless steel (629) grip
625	Lock Finish
RHR	Handing

Trim Only						
Quantity	Trim/Function	Technology Code	Lever Finish	Lock ² Finish	Hand	Option
2	23M	TCAC2	29BH29	625	RHR	M800

²Escutcheons (lock finish) are plated to match satin stainless steel (630) and polished stainless steel (629) finishes.



Experience a safer and more open world

ED5200(S)(A) Rim/SecureBolt® Device
Lever Design: A, C, D, E, L, N, PR, R

Lever: Cast **Keypad/Controller Escutcheon:** Zinc Die Cast
Trim Escutcheon: Forged

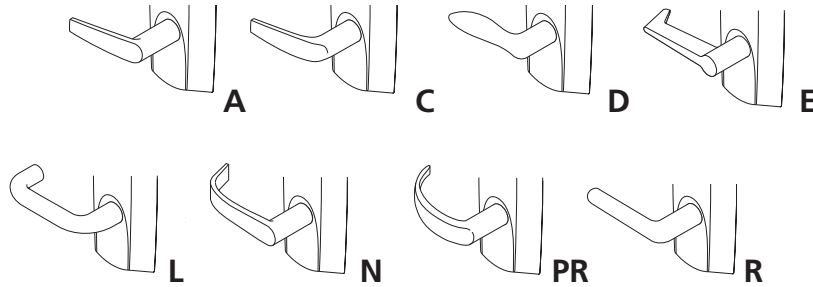

Lever Design: FR, M, Z

Lever: Cast **Keypad/Controller Escutcheon:** Zinc Die Cast
Trim Escutcheon: Forged

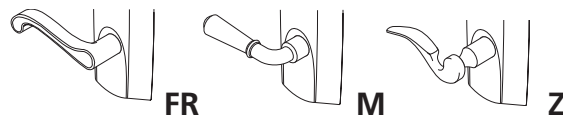

Use with ED5200(S)(A) Rim/SecureBolt® Device

Note: Exit Device ordered separately, starting on page 201.

Function*	Description	A, C, D, E, FR, L, M, N, R, PR, Z
		Finish: 605, 606, 611, 612, 613, 613E, 618, 619, 625, 626, 629, 630, 722, BSP, WSP
9833ET	Without key override x M800	\$1,392.00
9834ET	With key override x M800	

Note: For key override add Cylinder Quick Code Option and price.
*When specifying function, prefix with lever design.
Refer to ED7000 sections for mechanical push bar pricing.
Refer to the ED5000 section push pad exit device for order info.

Access 800® Options

Description	Specify	Add
100 User, keypad only	M800	No Charge
2000 User, keypad only	M801	\$155.00
2000 User, proximity only	M802	\$587.00
2000 User, keypad and proximity	M803	\$652.00
2000 User, keypad and RF actuation*	M804	\$369.00
2000 User, proximity and RF actuation*	M805	\$801.00
2000 User, keypad, proximity and RF actuation*	M806	\$865.00

* Note: RF Fob must be ordered separately. See page 104.

ED5633(A)L & ED5634(A)L Mortise Device

Lever Design: A, C, D, E, L, N, PR, R

Lever: Cast

Keypad/Controller Escutcheon: Zinc Die Cast

Trim Escutcheon: Forged

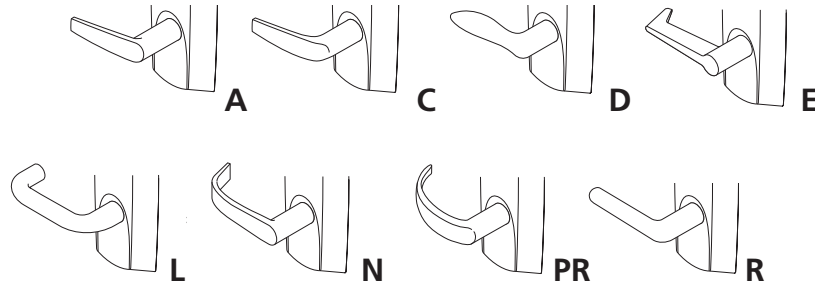

Lever Design: FR, M, Z

Lever: Cast

Keypad/Controller Escutcheon: Zinc Die Cast

Trim Escutcheon: Forged

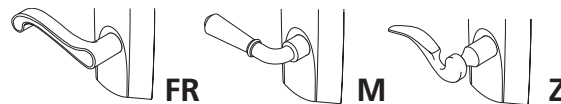

Use with ED5633(A)L & ED5634(A)L Mortise Device

Note: Exit Device ordered separately, starting on page 201.

Function*	Description	A, C, D, E, FR, L, M, N, R, PR, Z
		Finish: 605, 606, 611, 612, 613, 613E, 618, 619, 625, 626, 629, 630, 722, BSP, WSP
9M833ET	Without key override x M800	\$1,344.00
9M834ET	With key override x M800	

Note: 9M833ET and 9M834ET cannot be retrofitted to an existing ED5600 Series mortise device. When ordered as "Trim Only", 9M833ET and 9M834ET will be furnished with the appropriate mortise lock (refer to Parts Price List for mortise lock body pricing). If a "Trim Only" order is intended for retrofitting and exit device with an M91 Bolt Monitor or an M93 Trim Monitor function, that function must be specified with the trim order to ensure the correct lock is furnished.

Note: For key override, add Cylinder Quick Code Option and price. See page 117.

*When specifying function, prefix with lever design.

Refer to ED7000 sections for mechanical push bar pricing.

Refer to the ED5000 section push pad exit device for order info.

Access 800® Options

Description	Specify	Add
100 User, keypad only	M800	No Charge
2000 User, keypad only	M801	\$155.00
2000 User, proximity only	M802	\$587.00
2000 User, keypad and proximity	M803	\$652.00
2000 User, keypad and RF actuation*	M804	\$369.00
2000 User, proximity and RF actuation*	M805	\$801.00
2000 User, keypad, proximity and RF actuation*	M806	\$865.00
Gasket	M99	No Charge

Notes: 1. Available 0-bitted and Key Random (KR) only.

2. Available 0-bitted only.

* Note: RF Fob must be ordered separately. See page 104.

Exit Device ED5000 Series Cylinder Options*

Description	Specify	Add or Deduct
Conventional 6-pin	6P**	Add \$93.00 per cylinder
Conventional 7-pin	7P	Add \$95.00 per cylinder
Access 3 Patented	AP	Add \$93.00 per cylinder
Access 3 Security	AS	Add \$142.00 per cylinder
Access 3 High Security, UL 437	AHS	Add \$162.00 per cylinder
Access 3 IC Patented	ACP	Add \$173.00 per cylinder
Access 3 IC Security	ACS	Add \$222.00 per cylinder
Access 3 IC High Security, UL 437	ACHS	Add \$242.00 per cylinder
Pyramid Security Fixed Core	PS	Add \$157.00 per cylinder
Pyramid Security IC	PCS	Add \$233.00 per cylinder
Pyramid High Security Fixed Core	PHS	Add \$189.00 per cylinder
Pyramid High Security IC	PCHS	Add \$264.00 per cylinder
Pyramid IC with Temporary Construction Core	CTP	Add \$173.00 per cylinder
Pyramid IC with Temporary Disposable Core	CTPD	Add \$93.00 per cylinder
Pyramid IC Less Core	CLP	Add \$93.00 per cylinder
Security	HS	Add \$214.00 per cylinder
Security IC	CHS	Add \$292.00 per cylinder
IC 6-pin	C6	Add \$173.00 per cylinder
IC 6-pin with Temporary Construction Core (Red)	CT6R	Add \$173.00 per cylinder
IC 6-pin with Temporary Construction Core (Blue)	CT6B	Add \$173.00 per cylinder
IC 6-pin with Temporary Construction Core (Green)	CT6G	Add \$173.00 per cylinder
IC 6-pin with Temporary Disposable Core	CT6D	Add \$93.00 per cylinder
IC 6-pin less core	CL6	Add \$93.00 per cylinder
SFIC 6-pin with Less Core	CLS6	Add \$93.00 per cylinder
IC 6-pin with SFIC disposable temporary core	CT6SD	Add \$93.00 per cylinder
IC 7-pin	C7	Add \$177.00 per cylinder
IC 7-pin with Temporary Construction Core (Red)	CT7R	Add \$177.00 per cylinder
IC 7-pin with Temporary Construction Core (Blue)	CT7B	Add \$177.00 per cylinder
IC 7-pin with Temporary Construction Core (Green)	CT7G	Add \$177.00 per cylinder
IC 7-pin with Temporary Disposable Core	CT7D	Add \$95.00 per cylinder
IC 7-pin less core	CL7	Add \$95.00 per cylinder
SFIC 7-pin with Less Core	CLS7	Add \$95.00 per cylinder
IC 7-pin with SFIC disposable temporary core	CT7SD	Add \$95.00 per cylinder

*Optional dogging cylinder will be furnished with the same mechanism and keyed alike with the trim cylinder, unless otherwise specified. If different keying or cylinder type is required, specify outside (trim) first, then inside (dogging) cylinder.

**6P cylinder option is supplied in 6-pin, L4 keyway, 0-bitted with two nickel silver keys.

Keying Options*

Description	Specify	Add or Deduct
0-Bitted with 2 blank keys	(standard)	No Charge
Keyed random	KR	No Charge
Construction master keyed ^{1,2}	CMK	Add \$16.00 per cylinder
Visual key control (VKC)		
- No stamping	VKC0	\$4.50
- Keys only	VKC1	No Charge
- Cylinders and keys ³	VKC2	\$8.00
- Cylinders only ³	VKC3	\$8.00
Concealed key control (CKC)		
- CKC cylinders with VKC keys	CKC2	\$8.00
- CKC cylinders only ³	CKC3	\$8.00
More than 2 keys per lock	KY# (e.g., KY6)	See page 31 - Cut Keys Section

*For key bows other than 10 and 90, specify "KB" + bow number as Quick Code, e.g. KB12.

Notes:

1. CMK Construction master keying charge is in addition to master keying charge.
2. CMK Construction master keying is not available in interchangeable core, Access 3, Pyramid, or Security series.
3. VKC2, VKC3, CKC3 are not available in Pyramid or Security series.

Strike Options*

Description	Specify	Add or Deduct
Mortise Device		
-ANSI strike for pair of doors w/astragal (7/8" L to C)	SS078	No Charge
-Open back strike for 1-3/4" door	SB134	Add \$87.00 per device
-Open back strike for 2-1/4" door	SB214	\$140.00

*(To purchase strike separately, see catalog or parts manual for part no.)

Door Thickness Options

Description	Specify	Add or Deduct
1-3/4"	(standard)	No Charge
2"	D200	No Charge
2-1/4"	D214	No Charge

Door Width Options

Description	Specify	Add or Deduct
24"	W024	Add \$305.00 per device
36"	(standard)	No Charge
48"	W048	Add \$37.00 per device

Miscellaneous Options

Description	Specify	Add or Deduct
Torx® Head Screws	M04	Add \$48.00 per device
ANSI wrought strike box (mortise)	M17	No Charge
Knurling outside & inside (embossed touchbar - device side) ¹	M20	Add \$153.00 per device
Knurling outside only (trim side) ¹	M21	Add \$72.00 per device
Knurling inside only (embossed touchbar - device side)	M22	Add \$81.00 per device
Abrasive coat outside and inside (trim and device) ¹	M23	Add \$97.00 per device
Abrasive coat inside only (device side)	M24	Add \$51.00 per device
Abrasive coat outside only (trim side) ¹	M25	Add \$46.00 per device
Power/Remote Unlocking Harness	M35	Add \$52.00 per lockset
Less dogging	M51	No Charge
Cylinder dogging	M52	Add \$82.00 per device
Sex nuts and bolts (SNBs)	M54	No Charge
Shim kit (for vision light)	M58	Add \$100.00 per device
Wood screws for use on fire-rated solid wood or wood core doors	M64	No Charge
Forced/Propped Door ²	M861	Add \$13.50 per lockset

Notes: 1. Not available with Vineyard™ or Muséo® levers.
 2. Not compatible with M800

Electrified Options

Description	Specify	Add or Deduct
Exit Alarm Device (cylinder not included)	M61	\$770.00
Bolt Position Monitoring	M91	Add \$227.00
Touchbar Monitoring or Signaling	M92*	Add \$213.00
Outside Monitoring or Signaling	M93	Add \$213.00
Motor Latch Retraction	MELR	Add \$852.00
Electric Dogging	M97	Add \$435.00

*M92 is included with M861 option.

Delayed Egress Options

Description	Specify	Add or Deduct
Delayed Egress (15-second delay)	D	Add \$1672.00
30-second delay (may be accepted by local jurisdiction)	M88	\$116.00
BOCA 15-second delay	M89	\$116.00
BOCA 30-second delay	M90	\$116.00

Electrified Accessories

Description	Specify	Add or Deduct
Power Supply 9VDC Output	784	\$495.00
Power Supply 1.0 Amp @ 24 VDC Output	BPS-24-1	\$355.00
Power Supply 2 Amp @ 24 VDC Output	BPS-24-2	\$722.00
SPDT Maintained Switch (includes LED)	MKA	\$134.00
SPDT Maintained Switch (includes LED)	MKAN	\$214.00
SPDT Momentary Switch (includes LED)	MK	\$214.00
SPDT Momentary Switch (illuminated)	PB3	\$159.00
SPDT Maintained (Alt. Action) Switch	PB3EA	\$125.00
Sonalert 90lbs. @ 2ft. 12-24VDC mounted on one gang stainless steel plate	PZ1	\$106.00
Alarm Kit (cylinder is not included)**	ED50AK	\$875.00
Concealed transfer for over 120° swing doors	EPTL	\$140.00

**Alarm Kit cannot be installed in the field to surface vertical rod device.
 Any attempt to do so voids all warranties

WM800



Function	Description	Finish: Dark Gray
WM800	Reader/Controller	\$1,230.00

Includes weather gasket and glass mounting kit

Custom Wiring Diagram Services:

Part Number	Description	Price
WD-BASIC	Basic riser / elevation diagrams	Contact 800-810-WIRE (9473) for pricing
WD-SPEC	Specification package	
WD-P2P	Point to Point package	
WD-SYSPK	System Package	
WD-SWP	Special Wiring Package	

Keypad Versions (w/Ribbon Cable)

Part Number	Description	Price
708F809	M800 (100 user, keypad only)	\$224.00
708F089	M801, M803, M804, M806 (2000 user keypad and keypad + prox)	\$526.00
708F099	M802, M805 (2000 user prox only)	\$428.00

100 User Controllers – Contact 800-810-WIRE (9473) for pricing

Part Number	Description	Price
708F819	M800 (100 user, keypad only) - Cylindrical	\$463.00
708F829	M800 (100 user, keypad only) - Mortise/Exits	

2000 User Cylindrical Controllers

Part Number	Description	Price
712F009	M801 (2000 user, keypad)	\$770.00
712F019	M802 or M803 (2000 user prox only or keypad + prox)	\$1,134.00
712F029	M804 (2000 user keypad + RF*)	\$1,026.00
712F039	M805 or M806 (prox + RF* or keypad + prox + RF*)	\$1,453.00

2000 User Mortise & Exit Controllers

Part Number	Description	Price
712F049	M801 (2000 user, keypad)	\$770.00
712F059	M802 or M803 (2000 user prox only or keypad + prox)	\$1,134.00
712F069	M804 (2000 user keypad + RF*)	\$1,026.00
712F079	M805 or M806 (prox + RF* or keypad + prox + RF*)	\$1,453.00

Software

Part Number	Description	Price
790F139	SoloPlus™ Software	\$376.00

* Note: RF Fob must be ordered separately. See page 104.

Credentials

Part Number	Description	Order Multiples*	Order Minimums	Price (Each)
767F479	C/R 26 bit iCLASS 210 blank	Order 25-	100	\$13.00
767F489	HID 26 bit iCLASS 210 blank	Order 25-	100	
794F329	C/R 26 bit ISO Prox II blank	Order 25-	100	
794F359	HID® 26 bit ISO Prox II with logo	Order 25-	100	
794F369	HID 26 bit ISO Prox II without logo	Order 25-	100	
794F429	C/R MicroProx® tag	Order 10-	100	\$10.00
794F449	HID MicroProx tag with customer site code	Order 10-	100	
708F999	RF FOB	Order 1	1	\$112.00

*Sold only in multiples of the number indicated.

Note: For HID credentials, site/facility code and card sequence numbers must be specified.

Hardware

Part Number	Description	Price
708F979	Conduit	\$16.00
793F039	784 Remote power supply (includes Plug-in Wall Transformer, 12 feet of shielded wire)	\$511.00
793F049	Plug in wall transformer	\$66.00
793F059	Cable assembly - power supply	\$63.00
793F069	Power/remote unlocking harness	\$68.00
793F199	Battery, Alkaline (AA) (single battery)	\$3.00
793F029	Ribbon Cable	\$38.00
712F089	New Enrollment Station	\$809.00
712F119	Forced/Propped Door Harness; when ordered separately	\$28.00
M861	Forced/Propped Door Function ordered with device	Add \$13.50 per lockset
M35	Power/Remote Unlocking Harness; ordered with device	Add \$52.00 per lockset
711F989	Power/Remote Unlocking Harness; when ordered separately	\$66.00

Gaskets

Part Number	Description	Price
794F509	Exit device - Keypad	\$12.00
794F519	Exit device trim	\$12.00
794F529	Cylindrical lock	\$16.00
794F539	Mortise lock	\$16.00

Accessories

Part Number	Description	Price
790F109	Data Transfer Device (DTD)	\$867.00

Notes: 1. Data Transfer Device (DTD) package includes: Handheld DTD, SoloPlus software CD, USB cable, four (4) AA batteries, instructions and a lanyard.

Blank Page

ML2000 Series:

MicroShield®	98
ML2000 Series	99

ML2000 Museo Series:

ML2000 Series: Museo Georgia, Pablo, Jackson, Salvador, Marc Levers, Inspire Trim	100
ML2000 Series: Museo Georgia, Pablo, Jackson, Salvador, Marc, Josef Levers, Roses & Thumbturns	101
ML2000 Series: Museo Josef, Georges Levers, Roses & Thumbturns	102
ML2000 Series: Museo Piet Levers, Roses & Thumbturns	103
ML2000 Series: Museo Piet Levers, Roses & Thumbturns	104
ML2000 Series: Museo Georgia, Pablo, Jackson, Salvador, Marc, Josef Levers & Escutcheons	105
ML2000 Series: Museo Josef, Georges Levers & Escutcheons	106
ML2000 Series: Museo Piet Levers & Escutcheons	107
ML2000 Series: Museo Piet Levers & Escutcheons	108

ML2000 Series:

ML2000 Series: LWA, RWA, LWN, LWM, LWP, LWR, LWVN	109
ML2000 Series: LSA, LSN, LSM, LSP, LSR, LSVN	110
ML2000 Series: ASA, CSA, NSA, PSA, RSA, NSM, NSN, NSP, NSR, NSVN	111
ML2000 Series: DSA, ESA, DSM, DSN, DSP, DSR, DSVN	112
ML2000 Series: GZA, GZB, GZF, GZH, YZA, YZB, YZF, YZH, GZM, GZP, GZR, GZVN	113
ML2000 Series Vineyard Collection: FSG, MSG, ZSG, FSL, MSL, ZSL, FSVN, MSVN, ZSVN	114
ML2000 Series: Deadbolts: M, N, P, L, R, VN	115
Vandal Resistant Trim: CSV, NSV	116

ML20900 Museo Series:

ML20900 Series: Museo Georgia, Pablo, Jackson, Salvador, Marc Levers & Roses	117
ML20900 Series: Museo Georgia, Pablo, Jackson, Salvador, Marc, Josef Levers, Escutcheons, Roses and Thumbturns	118
ML20900 Series: Museo Piet Levers, Escutcheons, Roses and Thumbturns	119
ML20900 Series: Museo Piet Levers, Escutcheons, Roses and Thumbturns	120
ML20900 Series: Museo Josef, Georges Levers, Escutcheons, Roses and Thumbturns	121

ML20900 Series:

ML20900 Series: LWA, RWA, LWM, LWN, LWR, ASA, CSA, LSA, NSA, PSA, RSA, NSM, NSN, NSR	122
ML20900 Series: DSA, ESA, DSM, DSN, DSR, CSV, NSV	123
ML20900 Series Vineyard Collection: FSG, MSG, ZSG, FSL, MSL, ZSL	124
ML20900 Series: GZA, GZB, GZF, GZH, YZA, YZB, YZF, YZH, GZM, GZP, GZR	125

ML20600 NAC Museo Series:

ML20600 NAC Series: Museo Georgia, Pablo, Jackson, Salvador, Marc Levers with High Security Monitoring	126
ML20600 NAC Series: Museo Georgia, Pablo, Jackson, Salvador, Marc, Josef Levers & Roses with High Security Monitoring	127
ML20600 NAC Series: Museo Piet Levers & Roses with High Security Monitoring	128
ML20600 NAC Series: Museo Piet Levers & Roses with High Security Monitoring	129
ML20600 NAC Series: Museo Josef, Georges Levers & Roses	130

ML20600 NAC Series:

ML20600 Series NAC: LWA, RWA, LWM, LWN, LWR, LWVN, ASA, CSA, LSA, NSA, PSA, RSA, NSM, NSN, NSR, NSVN	131
ML20600 Series NAC: DSA, ESA, DSM, DSN, DSR, DSVN, CSV, NSV	132
ML20600 Series NAC: Electrified Mortise with High Security Options: FSG, MSG, ZSG, FSL, MSL, ZSL, FSVN, MSVN, ZSVN	133

ML2000/20900 Series:

ML20600 NAC Series Lever Designs	134
ML2000 & ML20900 Series Ordering Options	135
ML2000 & ML20900 Series Cylinder & Keying Options	136
ML2000 & ML20900 Series Cylinder & Keying Options (Continued), ML2000/20900 Strike Options	137
ML2000 & ML20900 Series Door Thickness with Locksets Mortised on Center, Panel Applications	138
ML2000 & ML20900 Series Miscellaneous Options, Thumbturn Options	139
ML2000 & ML20900 Series Indicator Options, Sectional Trim Retrofit Kits for V Series Indicators, Ordering Examples	140



Look for the  *MicroShield* icon.

MicroShield®

As part of their promise to provide innovative solutions to their customers, certain ASSA ABLOY Group brands offer the MicroShield® technology, a silver-based antimicrobial coating designed to inhibit the growth of bacteria.

MicroShield® is a registered trademark of Yale Security Inc., an ASSA ABLOY Group company.

Product	Series	MicroShield® Coated Components
Mortise Locks	ML2000 Series	Knobs/Levers, roses and/or escutcheons

AVAILABLE FINISHES

- MicroShield® is available on 626 and 630. Other finishes available by Special Product Application Request Form only.
- Specify 626C (satin chrome plated) or 630C (satin stainless steel) when ordering.
- MicroShield® coating will be applied over 626 and 630 finishes. All components will match 626.

Note: MicroShield® coating will only be applied to "high touch" components.

HOW TO ORDER

Product	How to Order
Mortise Locks	ML2055 x LWA x 626C x RHR

Description	Add
Mortise Locks	Add \$69.00

**Standard Features
Handing**

Field reversible

Door Thickness

1-3/4"

Backset

2-3/4"

Warranty

10 Years

Strike

ANSI straight lip
4-7/8" x 1-1/4" x 1-1/8" lip to center

Cylinder

Brass, 6-pin, L4 keyway, 0-bitted

Keys

Two nickel silver keys

Case Quantity

6

Case Weight

Variable

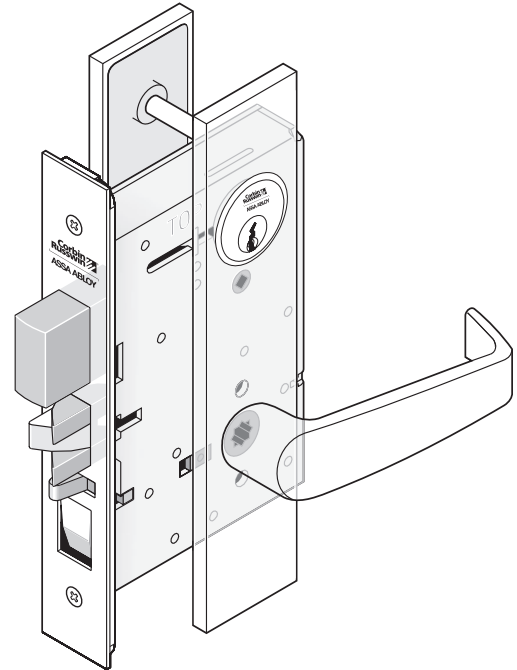

Please refer to the ML2000 Series catalog for more information.

Ordering Example:

Stock Order

Quantity	Series/Function	Trim	Finish	Hand
100	ML2055	LSB	626	RHR

Split Trim/Split Finish

Quantity	Series/Function	Trim		Finish		Hand
		Outside	Inside	Outside	Inside	
12	ML2055	LSB	GRC	626	625	RHR

Split trim is not available mixing escutcheon with sectional trim or with a different escutcheon

Contract/Detailed Order

Quantity	Keyset	Series/Function	Trim	Finish	Hand	Strike	Misc. Options	Cylinder and Keying
24	AA1	ML2055	LSB	626	RHR	SA200	M17-M26	C7-VKC3

Working Trim Only

Quantity	Function only	Trim	Finish	Hand	Door Thickness	Misc. Options
6	ML2055	LWA	626	RHR	D214	M31

(includes grip and spindle, rose or escutcheon, thumbturn, adapters and screws)

High Security Monitoring Option Order

Quantity	Series/Function	Technology Code	Trim	Finish	Hand	Fail Safe/ Fail Secure	High Security Monitoring Options
24	ML20608	NAC	ASA	626	RHR	SEC	PHRR01

Mortise Locksets

ML2000 Series: Muséo Levers and Inspire™ Roseless Trim

USA & Canada Prices Effective March 16, 2020

contemporary trim to complement the interior design of your next project

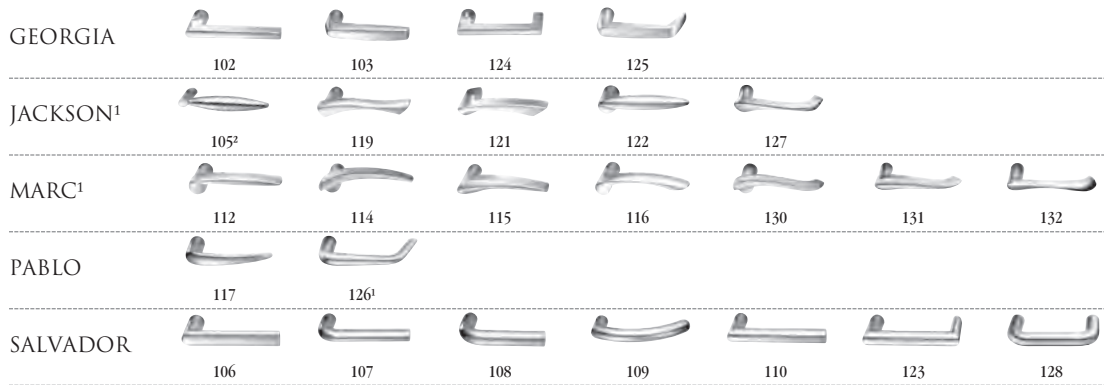

J Collar

¹Handed: specify hand when ordering.
²Contact factory for current lead time.

*629 and *630 finish options are Not available for all Muséo levers.
 Please refer to page 24 for availability.

613E	Dark Oxidized Satin Bronze - Equivalent	605	Bright Brass, Clear Coated	618	Bright Nickel Plated
626	Satin Chromium Plated	606	Satin Brass, Clear Coated	619	Satin Nickel Plated
BSP	Black Suede Powder Coat	611	Bright Bronze, Clear Coated	625	Bright Chromium Plated
WSP	White Suede Powder Coat	612	Satin Bronze, Clear Coated	629*	Bright Stainless Steel
		613	Dark Oxidized Satin Bronze, Oil Rubbed	630*	Satin Stainless Steel
		613L	Dark Oxidized Satin Bronze, Clear Coated	722	Black Oxidized Bronze, Oil Rubbed

Function

Function	Model	Description	Price	Price
Non-Keyed	ML2010	Passage	\$985.00	\$1,009.00
	ML2020	Privacy	\$1,084.00	\$1,108.00
	ML2030	Privacy		
	ML2060	Privacy	\$1,055.00	\$1,079.00
	ML2050	Half Dummy	\$375.00	\$387.00
	ML2070	Full Dummy	\$750.00	\$774.00
	ML2080	Half Active Dummy Trim	\$643.00	\$655.00
	ML2090	Full Active Dummy Trim	\$1,018.00	\$1,042.00
Single Cylinder	ML2003	Classroom		
	ML2051	Office		
	ML2055	Classroom	\$1,141.00	\$1,165.00
	ML2056	Classroom Holdback		
	ML2057	Storeroom		
	ML2069	Institution Privacy		
	ML2053	Entrance		
	ML2054	Entrance	\$1,154.00	\$1,178.00
Single Cylinder with Deadbolt	ML2024	Entrance		
	ML2048	Entrance		
	ML2049	Storeroom Deadbolt		
	ML2059	Security Storeroom	\$1,177.00	\$1,201.00
	ML2065	Dormitory		
	ML2067	Apartment		
	ML2073	Classroom Security		
	ML2075	Entrance/Office		
Double Cylinder	ML2029	Hotel	\$1,232.00	\$1,256.00
	ML2002	Classroom Intruder		
	ML2032	Institution		
	ML2042	Entrance	\$1,234.00	\$1,258.00
	ML2052	Classroom Intruder		
Double Cylinder with Deadbolt	ML2087	Security Vestibule		
	ML2022	Store Door		
	ML2062	Intruder Deadbolt		
	ML2072	Classroom Security Intruder	\$1,270.00	\$1,294.00
	ML2082	Dormitory		
ML2092	Security Institution			
Full Working Trim (Quick Code M31) No cylinder; includes thumbturn lever			\$790.00	\$814.00

Ordering Example Details

ML2000	ML2051	Office Function
Sectional Trim	102	Georgia Family Lever
(rose)	J	Collar
	625	Finish
	RHR	Handing

Stock Order

Quantity	Series/Function	Trim	Finish	Hand
24	ML2051	102J	625	RHR



Experience a safer and more open world

Copyright © 2002-2020 Corbin Russwin, Inc., an ASSA ABLOY Group company. All rights reserved. Reproduction in whole or in part without the express written permission of Corbin Russwin, Inc., is prohibited.

Contact us at: 800-543-3658 or visit www.corbinrusswin.com. In Canada contact us at: 800-461-3007 or visit www.assaabloydss.ca

Mortise Locksets

ML2000 Series: Muséo Levers, Roses and Thumbturns

USA & Canada Prices Effective March 16, 2020

contemporary levers to complement the interior design of your next project

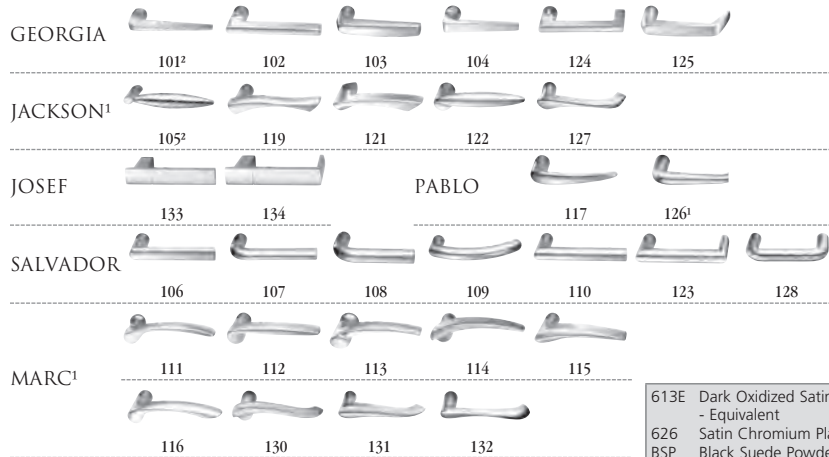

- 613E Dark Oxidized Satin Bronze - Equivalent
- 626 Satin Chromium Plated
- BSP Black Suede Powder Coat
- WSP White Suede Powder Coat

ROSES



THUMBTURN³



1. Handed: specify hand when ordering
2. Contact factory for current lead time
3. Specify thumbturn as quick code. Thumbturn backplate will match shape of rose chosen (i.e. round or square)

*629 and *630 finish options are Not available for all Muséo levers. Please refer to page 24 for availability.

Function

Non-Keypad	ML2010	Passage	\$895.00	\$919.00
	ML2020	Privacy	\$994.00	\$1,018.00
	ML2030	Privacy	\$970.00	\$994.00
	ML2060	Half Dummy	\$401.00	\$425.00
	ML2070	Full Dummy	\$802.00	\$826.00
	ML2080	Half Active Dummy Trim	\$533.00	\$557.00
	ML2090	Full Active Dummy Trim	\$934.00	\$958.00
Single Cylinder	ML2003	Classroom	\$1,051.00	\$1,075.00
	ML2051	Office		
	ML2055	Classroom		
	ML2056	Classroom Holdback		
	ML2057	Storeroom		
	ML2069	Institution Privacy		
	ML2053	Entrance		
ML2054	Entrance			
ML2058	Entrance Holdback			
ML2068	Privacy or Classroom			
Single Cylinder with Deadbolt	ML2024	Entrance	\$1,087.00	\$1,111.00
	ML2048	Entrance		
	ML2049	Storeroom Deadbolt		
	ML2059	Security Storeroom		
	ML2065	Dormitory		
	ML2067	Apartment		
	ML2073	Classroom Security		
ML2075	Entrance/Office			
ML2029	Hotel	\$1,142.00	\$1,166.00	
Double Cylinder	ML2002	Classroom Intruder	\$1,144.00	\$1,168.00
	ML2032	Institution		
	ML2042	Entrance		
	ML2052	Classroom Intruder		
ML2087	Security Vestibule			
Double Cylinder with Deadbolt	ML2022	Store Door	\$1,180.00	\$1,204.00
	ML2062	Intruder Deadbolt		
	ML2072	Classroom Security Intruder		
	ML2082	Dormitory		
ML2092	Security Institution			
Full Working Trim (Quick Code M31) No cylinder; includes thumbturn lever			\$705.00	\$729.00

Ordering Example Details

ML2000
Sectional Trim
(rose)

ML2051 Office Function
111 Marc Family Lever
W Rose
625 Finish
RHR Handing



Stock Order

Quantity	Series/Function	Trim	Finish	Hand
24	ML2051	111W	625	RHR



Experience a safer and more open world

Copyright © 2002-2020 Corbin Russwin, Inc., an ASSA ABLOY Group company. All rights reserved. Reproduction in whole or in part without the express written permission of Corbin Russwin, Inc. is prohibited. Contact us at: 800-543-3658 or visit www.corbinrusswin.com. In Canada contact us at: 800-461-3007 or visit www.assaabloydss.ca

Mortise Locksets

ML2000 Series: Muséo Levers, Roses and Thumbturns

USA & Canada Prices Effective March 16, 2020

contemporary levers to complement the interior design of your next project



JOSEF



GEORGES



ROSES

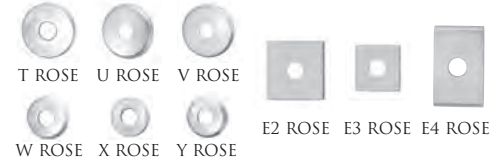

THUMBTURNS³



1. Handed: specify hand when ordering
2. Contact factory for current lead time
3. Specify thumbturn as quick code. Thumbturn backplate will match shape of rose chosen (i.e. round or square)

613E	Dark Oxidized Satin Bronze - Equivalent	605	Bright Brass, Clear Coated	618	Bright Nickel Plated
626	Satin Chromium Plated	606	Satin Brass, Clear Coated	619	Satin Nickel Plated
BSP	Black Suede Powder Coat	611	Bright Bronze, Clear Coated	625	Bright Chromium Plated
WSP	White Suede Powder Coat	612	Satin Bronze, Clear Coated	629	Bright Stainless Steel
		613	Dark Oxidized Satin Bronze, Oil Rubbed	630	Satin Stainless Steel
		613L	Dark Oxidized Satin Bronze, Clear Coated	722	Black Oxidized Bronze, Oil Rubbed

Function

Function	Model	Description	Price	Price
Non-Keyed	ML2010	Passage	\$1,129.00	\$1,153.00
	ML2020	Privacy		
	ML2030	Privacy	\$1,184.00	\$1,208.00
	ML2060	Privacy	\$1,155.00	\$1,179.00
	ML2050	Half Dummy	\$432.00	\$456.00
	ML2070	Full Dummy	\$888.00	\$912.00
	ML2080	Half Active Dummy Trim	\$668.00	\$692.00
	ML2090	Full Active Dummy Trim	\$1,124.00	\$1,148.00
Single Cylinder	ML2003	Classroom Office Classroom Classroom Holdback Storeroom Institution Privacy	\$1,241.00	\$1,265.00
	ML2051			
	ML2055			
	ML2056			
	ML2057	Entrance Entrance Entrance Holdback Privacy or Classroom	\$1,254.00	\$1,278.00
	ML2054			
	ML2058			
ML2068				
Single Cylinder with Deadbolt	ML2024	Entrance Entrance Storeroom Deadbolt Security Storeroom Dormitory Apartment Classroom Security Entrance/Office	\$1,277.00	\$1,301.00
	ML2048			
	ML2049			
	ML2059			
	ML2065			
	ML2067			
	ML2073			
	ML2075			
ML2029	Hotel	\$1,332.00	\$1,356.00	
Double Cylinder	ML2002	Classroom Intruder Institution Entrance Classroom Intruder Security Vestibule	\$1,334.00	\$1,358.00
	ML2032			
	ML2042			
	ML2052			
	ML2087			
Double Cylinder with Deadbolt	ML2022	Store Door Intruder Deadbolt Classroom Security Intruder Dormitory Security Institution	\$1,370.00	\$1,394.00
	ML2062			
	ML2072			
	ML2082			
	ML2092			
Full Working Trim (Quick Code M31) No cylinder; includes thumbturn lever			\$891.00	\$915.00

Ordering Example Details

ML2000	Sectional Trim (rose)	ML2051	Office Function
	135		Josef Family Lever
	E4		Rose
	625		Finish
	RHR		Handing



Stock Order

Quantity	Series/Function	Trim	Finish	Hand
24	ML2051	135E4	625	RHR



Experience a safer and more open world

Copyright © 2002-2020 Corbin Russwin, Inc., an ASSA ABLOY Group company. All rights reserved. Reproduction in whole or in part without the express written permission of Corbin Russwin, Inc., is prohibited. Contact us at: 800-543-3658 or visit www.corbinrusswin.com. In Canada contact us at: 800-461-3007 or visit www.assaabloydss.ca

Mortise Locksets

ML2000 Series: Muséo Levers, Roses and Thumbturns

USA & Canada Prices Effective March 16, 2020



contemporary trim to complement the interior design of your next project



*613E, BSP, WSP finishes are not available with 21M levers



613E	Dark Oxidized Satin Bronze – Equivalent
629	Bright Stainless Steel
630	Satin Stainless Steel
BSP	Black Suede Powder Coat
WSP	White Suede Powder Coat

Function

Non-Keyed	ML2010	Passage	\$1,068.00
	ML2020	Privacy	
	ML2030	Privacy	\$1,123.00
	ML2060	Privacy	\$1,099.00
	ML2050	Half Dummy	\$421.00
	ML2070	Full Dummy	\$842.00
	ML2080	Half Active Dummy Trim	\$647.00
	ML2090	Full Active Dummy Trim	\$1,068.00
Single Cylinder	ML2003	Classroom	
	ML2051	Office	
	ML2055	Classroom	
	ML2056	Classroom Holdback	\$1,180.00
	ML2057	Storeroom	
	ML2069	Institution Privacy	
	ML2053	Entrance	
	ML2054	Entrance	
Single Cylinder with Deadbolt	ML2058	Entrance Holdback	\$1,193.00
	ML2068	Privacy or Classroom	
	ML2024	Entrance	
	ML2048	Entrance	
	ML2049	Storeroom Deadbolt	
	ML2059	Security Storeroom	\$1,216.00
	ML2065	Dormitory	
	ML2067	Apartment	
Double Cylinder	ML2073	Classroom Security	
	ML2075	Entrance/Office	
	ML2029	Hotel	\$1,271.00
	ML2002	Classroom Intruder	
	ML2032	Institution	
	ML2042	Entrance	\$1,273.00
	ML2052	Classroom Intruder	
	ML2087	Security Vestibule	
Double Cylinder with Deadbolt	ML2022	Store Door	
	ML2062	Intruder Deadbolt	
	ML2072	Classroom Security Intruder	\$1,309.00
	ML2082	Dormitory	
	ML2092	Security Institution	
Full Working Trim (Quick Code M31) No cylinder; includes thumbturn lever			\$832.00

Ordering Example Details

ML2000 Sectional Trim (rose)	ML2051	Office Function
	21M	Piet Family Lever - Polished with Satin Insert
	V	Rose
	293029	Lever Finish
		Polished with satin stainless steel insert (630), polished stainless steel (629) shank and polished stainless steel (629) grip
629	Lock Finish	
RHR	Handing	

Stock Order					
Quantity	Series/Function	Trim	Lever Finish	Lock Finish	Hand
2	ML2051	21MV	293029	629	RHR



Experience a safer and more open world

Mortise Locksets

ML2000 Series: Muséo Levers, Roses and Thumbturns

USA & Canada Prices Effective March 16, 2020

contemporary levers to complement the interior design of your next project



PIET



ROSES



THUMBTURNS



Specify thumbturn as quick code. Thumbturn backplate will match shape of rose chosen (i.e. round or square)

613E	Dark Oxidized Satin Bronze – Equivalent
629	Bright Stainless Steel
630	Satin Stainless Steel
BSP	Black Suede Powder Coat
WSP	White Suede Powder Coat

Function

Function	Model	Description	Price
Non-Keyed	ML2010	Passage	\$1,153.00
	ML2020	Privacy	\$1,208.00
	ML2030	Privacy	\$1,179.00
	ML2060	Privacy	\$456.00
	ML2050	Half Dummy	\$912.00
	ML2070	Full Dummy	\$692.00
	ML2080	Half Active Dummy Trim	\$1,148.00
Single Cylinder	ML2090	Full Active Dummy Trim	\$1,265.00
	ML2003	Classroom	\$1,265.00
	ML2051	Office	
	ML2055	Classroom	
	ML2056	Classroom Holdback	
	ML2057	Storeroom	
	ML2069	Institution Privacy	\$1,278.00
	ML2053	Entrance	
ML2054	Entrance		
ML2058	Entrance Holdback		
ML2068	Privacy or Classroom	\$1,301.00	
Single Cylinder with Deadbolt	ML2024		Entrance
	ML2048		Entrance
	ML2049		Storeroom Deadbolt
	ML2059		Security Storeroom
	ML2065		Dormitory
	ML2067		Apartment
	ML2073		Classroom Security
	ML2075	Entrance/Office	
ML2029	Hotel	\$1,356.00	
Double Cylinder	ML2002	Classroom Intruder	\$1,358.00
	ML2032	Institution	
	ML2042	Entrance	
	ML2052	Classroom Intruder	
	ML2087	Security Vestibule	
Double Cylinder with Deadbolt	ML2022	Store Door	\$1,394.00
	ML2062	Intruder Deadbolt	
	ML2072	Classroom Security Intruder	
	ML2082	Dormitory	
	ML2092	Security Institution	
Full Working Trim (Quick Code M31) No cylinder; includes thumbturn lever			\$915.00

Ordering Example Details

ML2000	ML2051	Office Function
Sectional Trim	23M	Piet Family Lever - Wood Insert
(rose)	U	Rose
	29BH29	Lever Finish, Wood insert with polished stainless steel (629) shank and polished stainless steel (629) grip
	629	Lock Finish
	RHR	Handing

Stock Order

Quantity	Series/Function	Trim	Lever Finish	Lock Finish	Hand
2	ML2051	23MU	29BH29	629	RHR



Experience a safer and more open world

Copyright © 2002-2020 Corbin Russwin, Inc., an ASSA ABLOY Group company. All rights reserved. Reproduction in whole or in part without the express written permission of Corbin Russwin, Inc., is prohibited. Contact us at: 800-543-3658 or visit www.corbinrusswin.com. In Canada contact us at: 800-461-3007 or visit www.assaabloydss.ca

Mortise Locksets

ML2000 Series: Muséo Levers and Escutcheons

USA & Canada Prices Effective March 16, 2020



contemporary levers to complement the interior design of your next project

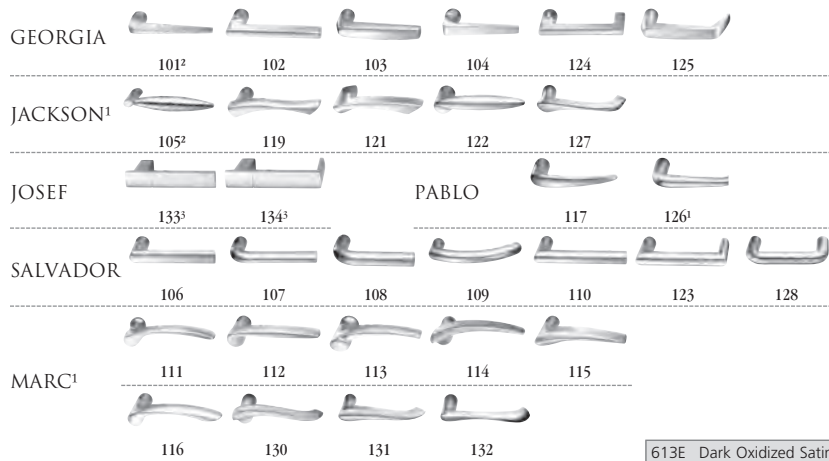

1. Handed: specify hand when ordering.
2. Contact factory for current lead time.
3. Not available with VN escutcheon.
4. VN escutcheon available only with indicators. Must be ordered with "V" indicator options. See page 140 for available functions. Option add also applies. Not available with 629 or 630 finish.

*629 and 630 finish options are Not available for all Muséo levers. Please refer to page 24 for availability.

613E	Dark Oxidized Satin Bronze - Equivalent	605	Bright Brass, Clear Coated	618	Bright Nickel Plated
626	Satin Chromium Plated	606	Satin Brass, Clear Coated	619	Satin Nickel Plated
BSP	Black Suede Powder Coat	611	Bright Bronze, Clear Coated	625	Bright Chromium Plated
WSP	White Suede Powder Coat	612	Satin Bronze, Clear Coated	629*	Bright Stainless Steel
		613	Dark Oxidized Satin Bronze, Oil Rubbed	630*	Satin Stainless Steel
		613L	Dark Oxidized Satin Bronze, Clear Coated	722	Black Oxidized Bronze, Oil Rubbed

Function

Function	Model	Description	Price (USA)	Price (Canada)
Non-Keyed	ML2010	Passage	\$949.00	\$973.00
	ML2020	Privacy	\$1,048.00	\$1,072.00
	ML2030	Privacy		
	ML2060	Privacy	\$1,024.00	\$1,048.00
	ML2050	Half Dummy	\$428.00	\$452.00
	ML2070	Full Dummy	\$856.00	\$880.00
	ML2080	Half Active Dummy Trim	\$560.00	\$584.00
	ML2090	Full Active Dummy Trim	\$988.00	\$1,012.00
Single Cylinder	ML2003	Classroom		
	ML2051	Office		
	ML2055	Classroom		
	ML2056	Classroom Holdback	\$1,105.00	\$1,129.00
	ML2057	Storeroom		
	ML2069	Institution Privacy		
	ML2053	Entrance		
ML2054	Entrance			
Single Cylinder with Deadbolt	ML2058	Entrance Holdback	\$1,118.00	\$1,142.00
	ML2068	Privacy or Classroom		
	ML2024	Entrance		
	ML2048	Entrance		
	ML2049	Storeroom Deadbolt		
	ML2059	Security Storeroom	\$1,141.00	\$1,165.00
	ML2065	Dormitory		
ML2067	Apartment			
Double Cylinder	ML2073	Classroom Security		
	ML2075	Entrance/Office		
	ML2029	Hotel	\$1,196.00	\$1,220.00
	ML2002	Classroom Intruder		
	ML2032	Institution	\$1,198.00	\$1,222.00
	ML2042	Entrance		
	ML2052	Classroom Intruder		
Double Cylinder with Deadbolt	ML2022	Store Door		
	ML2062	Intruder Deadbolt		
	ML2072	Classroom Security Intruder	\$1,234.00	\$1,258.00
	ML2082	Dormitory		
	ML2092	Security Institution		
Full Working Trim (Quick Code M31) No cylinder; includes thumbturn lever			\$759.00	\$783.00

Ordering Example Details

ML2000 Escutcheon Trim
 ML2051 Office Function
 111 Marc Family Lever
 L Escutcheon
 619 Finish
 RHR Handing

Stock Order

Quantity	Series/Function	Trim	Finish	Hand
24	ML2051	111L	619	RHR



Experience a safer and more open world

Mortise Locksets

ML2000 Series: Muséo Levers and Escutcheons

USA & Canada Prices Effective March 16, 2020

contemporary levers to complement the interior design of your next project



JOSEF



135 136 137 138

GEORGES



139 140 141 142 143



L ESCUTCHEON



R ESCUTCHEON

1. Handed: specify hand when ordering.
2. Contact factory for current lead time.
3. Not available with escutcheon indicators.

613E	Dark Oxidized Satin Bronze - Equivalent	605	Bright Brass, Clear Coated	618	Bright Nickel Plated
626	Satin Chromium Plated	606	Satin Brass, Clear Coated	619	Satin Nickel Plated
BSP	Black Suede Powder Coat	611	Bright Bronze, Clear Coated	625	Bright Chromium Plated
WSP	White Suede Powder Coat	612	Satin Bronze, Clear Coated	629	Bright Stainless Steel
		613	Dark Oxidized Satin Bronze, Oil Rubbed	630	Satin Stainless Steel
		613L	Dark Oxidized Satin Bronze, Clear Coated	722	Black Oxidized Bronze, Oil Rubbed

Function

Function	Model	Description	Price	Price
Non-Keyed	ML2010	Passage	\$1,202.00	\$1,226.00
	ML2020	Privacy		
	ML2030	Privacy	\$1,257.00	\$1,281.00
	ML2060	Privacy	\$1,228.00	\$1,252.00
	ML2050	Half Dummy	\$468.50	\$492.50
	ML2070	Full Dummy	\$961.00	\$985.00
	ML2080	Half Active Dummy Trim	\$704.50	\$728.50
	ML2090	Full Active Dummy Trim	\$1,197.00	\$1,221.00
Single Cylinder	ML2003	Classroom		
	ML2051	Office		
	ML2055	Classroom	\$1,314.00	\$1,338.00
	ML2056	Classroom Holdback		
	ML2057	Storeroom		
	ML2069	Institution Privacy		
	ML2053	Entrance		
ML2054	Entrance	\$1,327.00	\$1,351.00	
	ML2058	Entrance Holdback		
	ML2068	Privacy or Classroom		
Single Cylinder with Deadbolt	ML2024	Entrance		
	ML2048	Entrance		
	ML2049	Storeroom Deadbolt		
	ML2059	Security Storeroom	\$1,350.00	\$1,374.00
	ML2065	Dormitory		
	ML2067	Apartment		
	ML2073	Classroom Security		
ML2075	Entrance/Office			
	ML2029	Hotel	\$1,405.00	\$1,429.00
Double Cylinder	ML2002	Classroom Intruder		
	ML2032	Institution	\$1,407.00	\$1,431.00
	ML2042	Entrance		
	ML2052	Classroom Intruder		
Double Cylinder with Deadbolt	ML2022	Store Door		
	ML2062	Intruder Deadbolt		
	ML2072	Classroom Security Intruder	\$1,443.00	\$1,467.00
	ML2082	Dormitory		
	ML2092	Security Institution		
Full Working Trim (Quick Code M31) No cylinder; includes thumb-turn lever			\$964.00	\$988.00



Ordering Example Details

ML2000 Escutcheon Trim

ML2051 Office Function
 135 Josef Family Lever
 L Escutcheon
 619 Finish
 RHR Handing

Stock Order

Quantity	Series/Function	Trim	Finish	Hand
24	ML2051	135L	619	RHR



Experience a safer and more open world

Mortise Locksets

ML2000 Series: Muséo Levers and Escutcheons

USA & Canada Prices Effective March 16, 2020

contemporary levers to complement the interior design of your next project



PIET



*613E, BSP, WSP finishes are not available with 21M levers.

1. VN escutcheon available only with indicators.
Must be ordered with "V" indicator options.
See page 140 for available functions.
Option add also applies.
Not available with 629 or 630 finish.



(See Note 4)

613E	Dark Oxidized Satin Bronze – Equivalent
629	Bright Stainless Steel
630	Satin Stainless Steel
BSP	Black Suede Powder Coat
WSP	White Suede Powder Coat

Function

Non-Keypad	ML2010	Passage	\$1,141.00
	ML2020	Privacy	
	ML2030	Privacy	\$1,196.00
	ML2060	Privacy	\$1,172.00
	ML2050	Half Dummy	\$457.50
	ML2070	Full Dummy	\$915.00
	ML2080	Half Active Dummy Trim	\$683.50
	ML2090	Full Active Dummy Trim	\$1,141.00
Single Cylinder	ML2003	Classroom	
	ML2051	Office	
	ML2055	Classroom	
	ML2056	Classroom Holdback	\$1,253.00
	ML2057	Storeroom	
	ML2069	Institution Privacy	
		ML2053	Entrance
	ML2054	Entrance	
	ML2058	Entrance Holdback	\$1,266.00
	ML2068	Privacy or Classroom	
Single Cylinder with Deadbolt	ML2024	Entrance	
	ML2048	Entrance	
	ML2049	Storeroom Deadbolt	
	ML2059	Security Storeroom	\$1,289.00
	ML2065	Dormitory	
	ML2067	Apartment	
	ML2073	Classroom Security	
	ML2075	Entrance/Office	
	ML2029	Hotel	\$1,344.00
Double Cylinder	ML2002	Classroom Intruder	
	ML2032	Institution	
	ML2042	Entrance	\$1,346.00
	ML2052	Classroom Intruder	
Double Cylinder with Deadbolt	ML2022	Store Door	
	ML2062	Intruder Deadbolt	
	ML2072	Classroom Security Intruder	\$1,382.00
	ML2082	Dormitory	
	ML2092	Security Institution	
Full Working Trim (Quick Code M31) No cylinder; includes thumbturn lever			\$905.00



Ordering Example Details

ML2000
Escutcheon
Trim

ML2051 Office Function
21M Piet Family Lever - Polished with Satin Insert
L Escutcheon
293029 Lever Finish
Polished with satin stainless steel insert (630),
polished stainless steel (629) shank and
polished stainless steel (629) grip
629 Lock Finish
RHR Handing

Stock Order

Quantity	Series/Function	Trim	Lever Finish	Lock Finish	Hand
2	ML2051	21ML	293029	629	RHR



ASSA ABLOY

Experience a safer
and more open world

Copyright © 2002-2020 Corbin Russwin, Inc., an ASSA ABLOY Group company. All rights reserved.
Reproduction in whole or in part without the express written permission of Corbin Russwin, Inc., is prohibited.
Contact us at: 800-543-3658 or visit www.corbinrusswin.com. In Canada contact us at: 800-461-3007 or visit www.assaabloydss.ca

Mortise Locksets

ML2000 Series: Muséo Levers and Escutcheons

USA & Canada Prices Effective March 16, 2020

contemporary levers to complement the interior design of your next project



PIET



L ESCUTCHEON

R ESCUTCHEON

VN ESCUTCHEON

(See Note 4)

- 1. VN escutcheon available only with indicators. Must be ordered with "V" indicator options. See page 140 for available functions. Option add also applies. Not available with 629 or 630 finish.

613E	Dark Oxidized Satin Bronze – Equivalent
629	Bright Stainless Steel
630	Satin Stainless Steel
BSP	Black Suede Powder Coat
WSP	White Suede Powder Coat

Function

Category	Model	Function	Price
Non-Keyed	ML2010	Passage	\$1,226.00
	ML2020	Privacy	\$1,281.00
	ML2030	Privacy	
	ML2060	Privacy	\$1,252.00
	ML2050	Half Dummy	\$492.50
	ML2070	Full Dummy	\$985.00
	ML2080	Half Active Dummy Trim	\$728.50
	ML2090	Full Active Dummy Trim	\$1,221.00
Single Cylinder	ML2003	Classroom	\$1,338.00
	ML2051	Office	
	ML2055	Classroom	
	ML2056	Classroom Holdback	
	ML2057	Storeroom	
	ML2069	Institution Privacy	
Single Cylinder	ML2053	Entrance	\$1,351.00
	ML2054	Entrance	
	ML2058	Entrance Holdback	
	ML2068	Privacy or Classroom	
Single Cylinder with Deadbolt	ML2024	Entrance	\$1,374.00
	ML2048	Entrance	
	ML2049	Storeroom Deadbolt	
	ML2059	Security Storeroom	
	ML2065	Dormitory	
	ML2067	Apartment	
	ML2073	Classroom Security	
	ML2075	Entrance/Office	
ML2029	Hotel	\$1,429.00	
Double Cylinder	ML2002	Classroom Intruder	\$1,431.00
	ML2032	Institution	
	ML2042	Entrance	
	ML2052	Classroom Intruder	
Double Cylinder with Deadbolt	ML2022	Store Door	\$1,467.00
	ML2062	Intruder Deadbolt	
	ML2072	Classroom Security Intruder	
	ML2082	Dormitory	
	ML2092	Security Institution	
Full Working Trim (Quick Code M31) No cylinder; includes thumbturn lever			\$988.00



Ordering Example Details

ML2000	ML2051	Office Function
Escutcheon	23M	Piet Family Lever - Wood Insert
Trim	L	Escutcheon
	29BH29	Lever Finish
		Wood insert with polished stainless steel (629) shank and polished stainless steel (629) grip
	629	Lock Finish
	RHR	Handing

Stock Order

Quantity	Series/Function	Trim	Lever Finish	Lock Finish	Hand
2	ML2051	23M	29BH29	629	RHR



Experience a safer and more open world



LWA



RWA

Lever: Wrought
Rose: Wrought

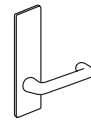

LWM

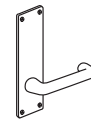

LWN

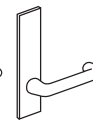

LWP

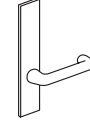

LWR

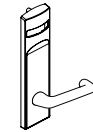

LWVN

Lever: Wrought
Escutcheon: Wrought

Lever: Wrought
Esc: Solid Stainless
Steel or Forged Brass

Lever: Wrought
Escutcheon:
Forged Brass

Levers: LW, RW	
Roses: A	
Roses: B, F (see note 1)	
613E, 626, BSP, WSP	605, 606, 611, 612, 613, 618, 619, 625, 629, 630, 722

Levers: LW, RW	
Escutcheons: M, N, P	
613E, 626, BSP, WSP	605, 606, 611, 612, 613, 618, 619, 625, 629, 630, 722

Levers: LW, RW	
Escutcheons: R (see note 2)	
VN (see note 3)	
613E, 626, BSP, WSP	605, 606, 611, 612, 613, 618, 619, 625, 629, 630, 722

Function	Model	Description	613E, 626, BSP, WSP	605, 606, 611, 612, 613, 618, 619, 625, 629, 630, 722	613E, 626, BSP, WSP	605, 606, 611, 612, 613, 618, 619, 625, 629, 630, 722	613E, 626, BSP, WSP	605, 606, 611, 612, 613, 618, 619, 625, 629, 630, 722
Non-Keyed	ML2010	Passage	\$707.00	\$731.00	\$727.00	\$751.00	\$781.00	\$805.00
	ML2020	Privacy						
	ML2030	Privacy	\$826.00	\$850.00	\$846.00	\$870.00	\$900.00	\$924.00
	ML2060	Privacy	\$763.00	\$787.00	\$783.00	\$807.00	\$837.00	\$861.00
	ML2050	Half Dummy	\$417.00	\$429.00	\$427.00	\$451.00	\$454.00	\$478.00
	ML2070	Full Dummy	\$834.00	\$858.00	\$854.00	\$878.00	\$908.00	\$932.00
	ML2080	Half Active Dummy Trim	\$303.00	\$315.00	\$323.00	\$347.00	\$377.00	\$401.00
	ML2090	Full Active Dummy Trim	\$720.00	\$744.00	\$740.00	\$764.00	\$794.00	\$818.00
Single Cylinder	ML2003	Classroom						
	ML2051	Office						
	ML2055	Classroom	\$837.00	\$861.00	\$857.00	\$881.00	\$911.00	\$935.00
	ML2056	Classroom						
	ML2057	Storeroom						
	ML2069	Institution Privacy						
	ML2053	Entrance						
	ML2054	Entrance	\$850.00	\$874.00	\$870.00	\$894.00	\$924.00	\$948.00
ML2058	Entrance Holdback							
ML2068	Privacy or Apartment							
Single Cylinder with Deadbolt	ML2024	Entrance						
	ML2048	Entrance						
	ML2049	Storeroom Deadbolt						
	ML2065	Dormitory	\$873.00	\$897.00	\$893.00	\$917.00	\$947.00	\$971.00
	ML2059	Security Storeroom						
	ML2067	Apartment						
	ML2073	Classroom Security						
	ML2075	Entrance/Office						
ML2029	Hotel	\$928.00	\$952.00	\$948.00	\$972.00	\$1,002.00	\$1,026.00	
Double Cylinder	ML2002	Classroom Intruder						
	ML2032	Institution						
	ML2042	Entrance	\$930.00	\$954.00	\$950.00	\$974.00	\$1,004.00	\$1,028.00
	ML2052	Classroom Intruder						
	ML2087	Security Vestibule					N/A	N/A
Double Cylinder with Deadbolt	ML2022	Store Door						
	ML2062	Intruder Deadbolt						
	ML2072	Classroom Security	\$966.00	\$990.00	\$986.00	\$1,010.00	\$1,040.00	\$1,064.00
	ML2082	Intruder						
	ML2092	Dormitory Security Institution						
Full Working Trim (Quick Code M31) No cylinder; includes thumbturn lever			\$610.00	\$634.00	\$630.00	\$654.00	\$684.00	\$708.00

NOTES: 1. Rose substitutions for LWA, RWA: 2-1/4" cast rose in place of 2-1/4" wrought rose, substitute letter "B" in place of "A" (e.g. LWB). **Add \$38.00 per lockset.**
2-7/8" cast rose in place of 2-1/4" wrought rose, substitute letter "F" in place of "A" (e.g. RWF). **Add \$52.00 per lockset.**

2. "R" Escutcheon trims are available for 1 3/8", 1 3/4", 2", or 2 1/4" door thickness only.

3. VN escutcheon available only with indicators. Must be ordered with "V" indicator options. See page 140 for available functions. Option add also applies. Not available with 629 or 630 finish.

LSA

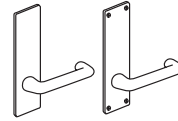
 Lever: Cast
Rose: Wrought

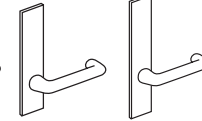
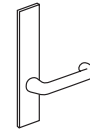
LSM LSN

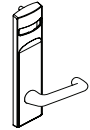
 Lever: Cast
Escutcheon: Wrought

LSP

LSR

 Lever: Cast
Esc: Solid Stainless
Steel or Forged Brass

LSVN

 Lever: Cast
Escutcheon:
Forged Brass

**Levers: LS
Roses: A
Roses: B, F (see note 1)**

613E, 626, BSP, WSP	605, 606, 611, 612, 613, 618, 619, 625, 629, 630, 722
---------------------------	-------------------------------------------------------------

**Levers: LS
Escutcheons: M, N, P**

613E, 626, BSP, WSP	605, 606, 611, 612, 613, 618, 619, 625, 629, 630, 722
---------------------------	-------------------------------------------------------------

**Levers: LS
Escutcheons: R (see note 2)
VN (see note 3)**

613E, 626, BSP, WSP	605, 606, 611, 612, 613, 618, 619, 625, 629, 630, 722
---------------------------	-------------------------------------------------------------

Function

Function	Model	Description	613E, 626, BSP, WSP	605, 606, 611, 612, 613, 618, 619, 625, 629, 630, 722	613E, 626, BSP, WSP	605, 606, 611, 612, 613, 618, 619, 625, 629, 630, 722	613E, 626, BSP, WSP	605, 606, 611, 612, 613, 618, 619, 625, 629, 630, 722
Non-Keyed	ML2010	Passage	\$733.00	\$823.00	\$887.00	\$911.00	\$921.00	\$945.00
	ML2020	Privacy	\$832.00	\$922.00	\$986.00	\$1,010.00	\$1,020.00	\$1,044.00
	ML2030	Privacy						
	ML2060	Privacy	\$808.00	\$898.00	\$962.00	\$986.00	\$996.00	\$1,020.00
	ML2050	Half Dummy	\$273.00	\$363.00	\$528.00	\$552.00	\$545.00	\$569.00
	ML2070	Full Dummy	\$546.00	\$636.00	\$1,056.00	\$1,080.00	\$1,090.00	\$1,114.00
	ML2080	Half Active Dummy Trim	\$499.00	\$589.00	\$398.00	\$422.00	\$442.00	\$466.00
	ML2090	Full Active Dummy Trim	\$772.00	\$862.00	\$926.00	\$950.00	\$960.00	\$984.00
Single Cylinder	ML2003	Classroom Office	\$889.00	\$979.00	\$1,043.00	\$1,067.00	\$1,077.00	\$1,101.00
	ML2051							
	ML2055							
	ML2056	Classroom						
	ML2057	Storeroom						
	ML2069	Institution Privacy						
	ML2053	Entrance	\$902.00	\$992.00	\$1,056.00	\$1,080.00	\$1,090.00	\$1,114.00
ML2054	Entrance							
ML2058	Entrance Holdback							
ML2068	Privacy or Apartment							
Single Cylinder with Deadbolt	ML2024	Entrance	\$925.00	\$1,015.00	\$1,079.00	\$1,103.00	\$1,113.00	\$1,137.00
	ML2048							
	ML2049	Storeroom Deadbolt						
	ML2065	Dormitory						
	ML2059	Security Storeroom						
	ML2067	Apartment						
	ML2073	Classroom Security						
ML2075	Entrance/Office							
ML2029	Hotel	\$980.00	\$1,070.00	\$1,134.00	\$1,158.00	\$1,168.00	\$1,192.00	
Double Cylinder	ML2002	Classroom Intruder Institution	\$982.00	\$1,072.00	\$1,136.00	\$1,160.00	\$1,170.00	\$1,194.00
	ML2032							
	ML2042	Entrance						
	ML2052	Classroom Intruder						
ML2087	Security Vestibule					N/A	N/A	
Double Cylinder with Deadbolt	ML2022	Store Door	\$1,018.00	\$1,108.00	\$1,172.00	\$1,196.00	\$1,206.00	\$1,230.00
	ML2062	Intruder Deadbolt						
	ML2072	Classroom Security Intruder						
	ML2082	Dormitory						
ML2092	Security Institution							
Full Working Trim (Quick Code M31) No cylinder; includes thumbturn lever			\$585.00	\$675.00	\$959.00	\$983.00	\$993.00	\$1,017.00

 NOTES: 1. Rose substitutions for LSA: 2-1/4" cast rose in place of 2-1/4" wrought rose, substitute letter "B" in place of "A" (e.g. LSB). **Add \$38.00 per lockset.**

 2-7/8" cast rose in place of 2-1/4" wrought rose, substitute letter "F" in place of "A" (e.g. LSF). **Add \$52.00 per lockset.**

2. "R" Escutcheon trims are available for 1 3/8", 1 3/4", or 2 1/4" door thickness only

3. VN escutcheon available only with indicators. Must be ordered with "V" indicator options. See page 140 for available functions. Option add also applies. Not available with 629 or 630 finish.

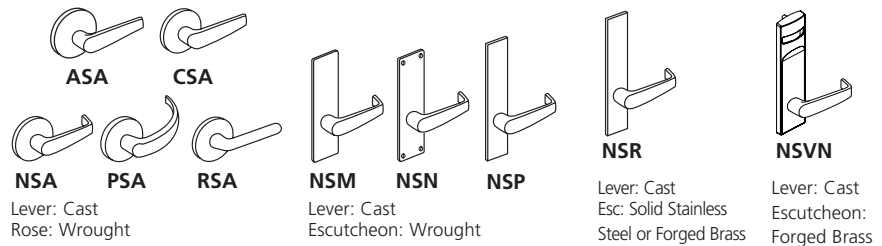

Levers: AS, CS, NS PS, RS	
Roses: A	
Roses: B, F (see note 1)	
613E, 626, BSP, WSP	605, 606, 611, 612, 613, 618, 619, 625, 629, 630, 722

Levers: AS, CS, NS, PS, RS	
Escutcheons: M, N, P	
613E, 626, BSP, WSP	605, 606, 611, 612, 613, 618, 619, 625, 629, 630, 722

Levers: AS, CS, NS, PS, RS	
Escutcheons: R (see note 2)	
VN (see note 3)	
613E, 626, BSP, WSP	605, 606, 611, 612, 613, 618, 619, 625, 629, 630, 722

Function			613E, 626, BSP, WSP	605, 606, 611, 612, 613, 618, 619, 625, 629, 630, 722	613E, 626, BSP, WSP	605, 606, 611, 612, 613, 618, 619, 625, 629, 630, 722	613E, 626, BSP, WSP	605, 606, 611, 612, 613, 618, 619, 625, 629, 630, 722
Non-Keyed	ML2010	Passage	\$867.00	\$891.00	\$887.00	\$911.00	\$921.00	\$945.00
	ML2020	Privacy						
	ML2030	Privacy	\$966.00	\$990.00	\$986.00	\$1,010.00	\$1,020.00	\$1,044.00
	ML2060	Privacy	\$942.00	\$966.00	\$962.00	\$986.00	\$996.00	\$1,020.00
	ML2050	Half Dummy	\$518.00	\$530.00	\$528.00	\$552.00	\$545.00	\$569.00
	ML2070	Full Dummy	\$1,036.00	\$1,060.00	\$1,056.00	\$1,080.00	\$1,090.00	\$1,114.00
	ML2080	Half Active Dummy Trim	\$388.00	\$400.00	\$398.00	\$422.00	\$442.00	\$466.00
	ML2090	Full Active Dummy Trim	\$906.00	\$930.00	\$926.00	\$950.00	\$960.00	\$984.00
Single Cylinder	ML2003	Classroom						
	ML2051	Office						
	ML2055	Classroom	\$1,023.00	\$1,047.00	\$1,043.00	\$1,067.00	\$1,077.00	\$1,101.00
	ML2056	Classroom						
	ML2057	Storeroom						
	ML2069	Institution Privacy						
	ML2053	Entrance						
	ML2054	Entrance	\$1,036.00	\$1,060.00	\$1,056.00	\$1,080.00	\$1,090.00	\$1,114.00
	ML2058	Entrance Holdback						
	ML2068	Privacy or Apartment						
Single Cylinder with Deadbolt	ML2024	Entrance						
	ML2048	Entrance						
	ML2049	Storeroom Deadbolt						
	ML2065	Dormitory	\$1,059.00	\$1,083.00	\$1,079.00	\$1,103.00	\$1,113.00	\$1,137.00
	ML2059	Security Storeroom						
	ML2067	Apartment						
	ML2073	Classroom Security						
	ML2075	Entrance/Office						
	ML2029	Hotel	\$1,114.00	\$1,138.00	\$1,134.00	\$1,158.00	\$1,168.00	\$1,192.00
Double Cylinder	ML2002	Classroom Intruder						
	ML2032	Institution						
	ML2042	Entrance	\$1,116.00	\$1,140.00	\$1,136.00	\$1,160.00	\$1,170.00	\$1,194.00
	ML2052	Classroom Intruder						
	ML2087	Security Vestibule					N/A	N/A
Double Cylinder with Deadbolt	ML2022	Store Door						
	ML2062	Intruder Deadbolt						
	ML2072	Classroom Security	\$1,152.00	\$1,176.00	\$1,172.00	\$1,196.00	\$1,206.00	\$1,230.00
	ML2082	Intruder						
	ML2092	Security Institution						
Full Working Trim (Quick Code M31) No cylinder; includes thumbturn lever			\$939.00	\$963.00	\$959.00	\$983.00	\$993.00	\$1,017.00

NOTES: 1. Rose substitutions for ASA, CSA, etc.: 2-1/4" cast rose in place of 2-1/4" wrought rose, substitute letter "B" in place of "A" (e.g. NSB). **Add \$38.00 per lockset.**
2-7/8" cast rose in place of 2-1/4" wrought rose, substitute letter "F" in place of "A" (e.g. NSF). **Add \$52.00 per lockset.**

2. "R" Escutcheon trims are available for 1 3/8", 1 3/4", or 2 1/4" door thickness only.

3. VN escutcheon available only with indicators. Must be ordered with "V" indicator options. See page 140 for available functions. Option add also applies. Not available with 629 or 630 finish.

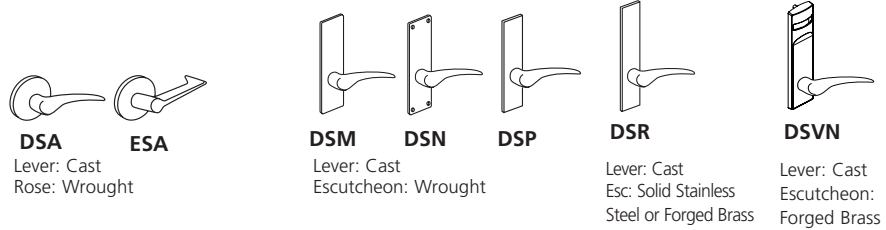

Levers: DS, ES	
Roses: A	
Roses: B, F (see note 1)	
613E, 626, BSP, WSP	605, 606, 611, 612, 613, 618, 619, 625, 629, 630, 722

Levers: DS, ES	
Escutcheons: M, N, P	
613E, 626, BSP, WSP	605, 606, 611, 612, 613, 618, 619, 625, 629, 630, 722

Levers: DS, ES	
Escutcheons: R (see note 2)	
VN (see note 3)	
613E, 626, BSP, WSP	605, 606, 611, 612, 613, 618, 619, 625, 629, 630, 722

Function								
Non-Keyed	ML2010	Passage	\$895.00	\$919.00	\$915.00	\$939.00	\$949.00	\$973.00
	ML2020	Privacy	\$994.00	\$1,018.00	\$1,004.00	\$1,028.00	\$1,048.00	\$1,072.00
	ML2030	Privacy						
	ML2060	Privacy	\$970.00	\$994.00	\$997.00	\$1,021.00	\$1,024.00	\$1,048.00
	ML2050	Half Dummy	\$401.00	\$425.00	\$411.00	\$435.00	\$428.00	\$452.00
	ML2070	Full Dummy	\$802.00	\$826.00	\$822.00	\$846.00	\$856.00	\$880.00
	ML2080	Half Active Dummy Trim	\$533.00	\$557.00	\$543.00	\$567.00	\$560.00	\$584.00
	ML2090	Full Active Dummy Trim	\$934.00	\$958.00	\$954.00	\$978.00	\$988.00	\$1,012.00
Single Cylinder	ML2003	Classroom						
	ML2051	Office						
	ML2055	Classroom	\$1,051.00	\$1,075.00	\$1,071.00	\$1,095.00	\$1,105.00	\$1,129.00
	ML2056	Classroom						
	ML2057	Storeroom						
	ML2069	Institution Privacy						
	ML2053	Entrance						
ML2054	Entrance	\$1,064.00	\$1,088.00	\$1,084.00	\$1,108.00	\$1,118.00	\$1,142.00	
ML2058	Entrance Holdback							
ML2068	Privacy or Apartment							
Single Cylinder with Deadbolt	ML2024	Entrance						
	ML2048	Entrance						
	ML2049	Storeroom Deadbolt						
	ML2065	Dormitory	\$1,087.00	\$1,111.00	\$1,107.00	\$1,131.00	\$1,141.00	\$1,165.00
	ML2059	Security Storeroom						
	ML2067	Apartment						
	ML2073	Classroom Security						
ML2075	Entrance/Office							
ML2029	Hotel	\$1,142.00	\$1,166.00	\$1,162.00	\$1,186.00	\$1,196.00	\$1,220.00	
Double Cylinder	ML2002	Classroom Intruder						
	ML2032	Institution						
	ML2042	Entrance	\$1,144.00	\$1,168.00	\$1,164.00	\$1,188.00	\$1,198.00	\$1,222.00
	ML2052	Classroom Intruder						
ML2087	Security Vestibule					N/A	N/A	
Double Cylinder with Deadbolt	ML2022	Store Door						
	ML2062	Intruder Deadbolt						
	ML2072	Classroom Security Intruder	\$1,180.00	\$1,204.00	\$1,200.00	\$1,224.00	\$1,234.00	\$1,258.00
	ML2082	Dormitory						
ML2092	Security Institution							
Full Working Trim (Quick Code M31) No cylinder; includes thumbturn lever			\$705.00	\$729.00	\$725.00	\$749.00	\$759.00	\$783.00

NOTES: 1. Rose substitutions for DSA, ESA: 2-1/4" cast rose in place of 2-1/4" wrought rose, substitute letter "B" in place of "A" (e.g. DSB). **Add \$38.00 per lockset.** 2-7/8" cast rose in place of 2-1/4" wrought rose, substitute letter "F" in place of "A" (e.g. ESF). **Add \$52.00 per lockset.**

2. "R" Escutcheon trims are available for 1 3/8", 1 3/4", or 2 1/4" door thickness only.

3. VN escutcheon available only with indicators. Must be ordered with "V" indicator options. See page 140 for available functions. Option add also applies. Not available with 629 or 630 finish.

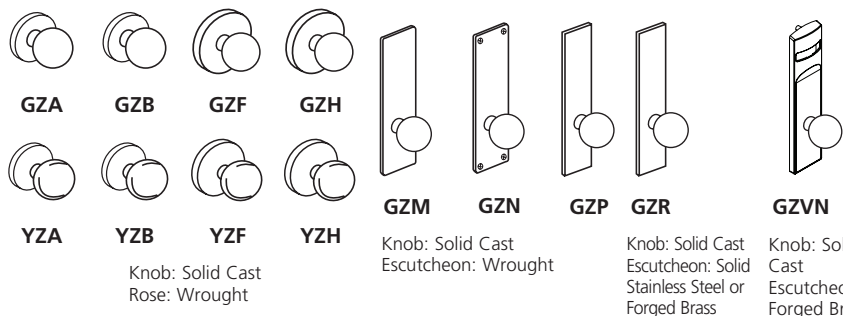

Function	Knobs: GZ, YZ Roses: A, H Roses: B, F (see note 2)		Knobs: GZ, YZ Escutcheons: M, N, P		Knobs: GZ, YZ Escutcheons: R (see note 2) VN (see note 3)			
	613E, 626, BSP, WSP	605, 606, 611, 612, 613, 618, 619, 625, 722	613E, 626, BSP, WSP	605, 606, 611, 612, 613, 618, 619, 625, 722	613E, 626, BSP, WSP	605, 606, 611, 612, 613, 618, 619, 625, 722		
Non-Keyed	ML2010	Passage	\$939.00	\$963.00	\$959.00	\$983.00	\$993.00	\$1,017.00
	ML2020	Privacy	\$1,002.00	\$1,026.00	\$1,022.00	\$1,046.00	\$1,056.00	\$1,080.00
	ML2030	Privacy						
	ML2060	Privacy	\$995.00	\$1,019.00	\$1,015.00	\$1,039.00	\$1,049.00	\$1,073.00
	ML2050	Half Dummy	\$554.00	\$578.00	\$564.00	\$576.00	\$581.00	\$593.00
	ML2070	Full Dummy	\$1,108.00	\$1,132.00	\$1,128.00	\$1,152.00	\$1,162.00	\$1,186.00
	ML2080	Half Active Dummy Trim	\$388.00	\$412.00	\$398.00	\$422.00	\$415.00	\$427.00
	ML2090	Full Active Dummy Trim	\$942.00	\$966.00	\$962.00	\$986.00	\$996.00	\$1,020.00
Single Cylinder	ML2003	Classroom	\$1,059.00	\$1,083.00	\$1,079.00	\$1,103.00	\$1,113.00	\$1,137.00
	ML2051	Office						
	ML2055	Classroom						
	ML2056	Classroom						
	ML2057	Storeroom	\$1,072.00	\$1,096.00	\$1,092.00	\$1,116.00	\$1,126.00	\$1,150.00
	ML2069	Institution Privacy						
	ML2053	Entrance						
	ML2054	Entrance						
ML2058	Entrance Holdback	\$1,095.00	\$1,119.00	\$1,115.00	\$1,139.00	\$1,149.00	\$1,173.00	
ML2068	Privacy or Apartment							
Single Cylinder with Deadbolt	ML2024	Entrance	\$1,150.00	\$1,174.00	\$1,170.00	\$1,194.00	\$1,204.00	\$1,228.00
	ML2048	Entrance						
	ML2049	Storeroom Deadbolt						
	ML2065	Dormitory						
	ML2059	Security Storeroom						
	ML2067	Apartment						
	ML2073	Classroom Security						
	ML2075	Entrance/Office						
ML2029	Hotel	\$1,152.00	\$1,176.00	\$1,172.00	\$1,196.00	\$1,206.00	\$1,230.00	
ML2002	Classroom Intruder							
ML2032	Institution							
ML2042	Entrance							
ML2052	Classroom Intruder							
ML2087	Security Vestibule	N/A	N/A					
Double Cylinder with Deadbolt	ML2022	Store Door	\$1,188.00	\$1,212.00	\$1,208.00	\$1,232.00	\$1,242.00	\$1,266.00
	ML2062	Intruder Deadbolt						
	ML2072	Classroom Security Intruder						
	ML2082	Dormitory						
	ML2092	Security Institution						
Full Working Trim (Quick Code M31) No cylinder; includes thumbturn lever.			\$1,011.00	\$1,035.00	\$1,031.00	\$1,055.00	\$1,065.00	\$1,089.00

- NOTES: 1. "R" Escutcheon trims are available for 1 3/8", 1 3/4", or 2 1/4" door thickness only.
 2. Rose substitutions: 2-1/4" cast rose in place of 2-1/4" wrought rose, substitute letter "B" in place of "A" (e.g. GZB). **Add \$38.00 per lockset.**
 2-7/8" cast rose in place of 2-1/4" wrought rose, substitute letter "F" in place of "A" (e.g. GZF). **Add \$52.00 per lockset.**
 3. VN escutcheon available only with indicators. Must be ordered with "V" indicator options. See page 140 for available functions. Option add also applies.

Lever Designs: FSG, MSG, ZSG



Frascati



Lever: Rose:
Cast Cast



FSG



MSG



ZSG



Lever Designs: FSL, MSL¹, ZSL, FSVN, MSVN, ZSVN



Merlot

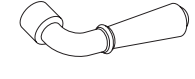

Lever: Escutcheon:
Cast Cast

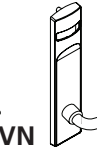
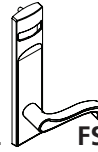
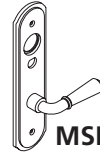

Zinfandel



Function	Description	FSG, MSG, ZSG		FSL, MSL, ZSL FSVN, MSVN, ZSVN (see note 3)		
		613E, 626, BSP, WSP	605, 606, 611, 612, 613 ² , 613L ² , 618, 619, 625, 722	613E, 626, BSP, WSP	605, 606, 611, 612, 613 ² , 613L ² , 618, 619, 625, 722	
Non-Keyed	ML2010	Passage	\$895.00	\$919.00	\$949.00	\$973.00
	ML2020	Privacy				
	ML2030	Privacy	\$994.00	\$1,018.00	\$1,048.00	\$1,072.00
	ML2060	Privacy	\$970.00	\$994.00	\$1,024.00	\$1,048.00
	ML2050	Half Dummy	\$401.00	\$425.00	\$428.00	\$452.00
	ML2070	Full Dummy	\$802.00	\$826.00	\$856.00	\$880.00
	ML2080	Half Active Dummy Trim	\$533.00	\$557.00	\$560.00	\$584.00
	ML2090	Full Active Dummy Trim	\$934.00	\$958.00	\$988.00	\$1,012.00
Single Cylinder	ML2003	Classroom Office	\$1,051.00	\$1,075.00	\$1,105.00	\$1,129.00
	ML2051					
	ML2055					
	ML2056					
	ML2057	Storeroom				
	ML2069	Institution Privacy				
	ML2053	Entrance				
ML2054	Entrance	\$1,064.00	\$1,088.00	\$1,118.00	\$1,142.00	
ML2058	Entrance Holdback					
ML2068	Privacy or Apartment					
Single Cylinder with Deadbolt	ML2024	Entrance	\$1,087.00	\$1,111.00	\$1,141.00	\$1,165.00
	ML2048	Entrance				
	ML2049	Storeroom Deadbolt				
	ML2059	Dormitory				
	ML2065	Security Storeroom				
	ML2067	Apartment				
	ML2073	Classroom Security				
ML2075	Entrance/Office					
ML2029	Hotel	\$1,142.00	\$1,166.00	\$1,196.00	\$1,220.00	
Double Cylinder	ML2002	Classroom Intruder	\$1,144.00	\$1,168.00	\$1,198.00	\$1,222.00
	ML2032	Institution				
	ML2042	Entrance				
	ML2052	Classroom Intruder				
	ML2087	Security Vestibule				
Double Cylinder with Deadbolt	ML2022	Store Door	\$1,180.00	\$1,204.00	\$1,234.00	\$1,258.00
	ML2062	Intruder Deadbolt				
	ML2072	Classroom Security Intrude				
	ML2082	Dormitory				
	ML2092	Security Institution				
Full Working Trim (Quick Code M31) No cylinder; includes thumbturn lever			\$705.00	\$729.00	\$759.00	\$783.00

NOTES: 1. Escutcheon trims are available for 1-3/8", 1-3/4" or 2-1/4" door thicknesses only.
 2. 613 finish is brass base lever & rose/escutcheon.
 3. VN escutcheon available only with indicators. Must be ordered with "V" indicator options. See page 140 for available functions. Option add also applies.

Deadbolt Only

Include lockcase, armored front, strike, screw pack, cylinder(s) and thumbturn lever.

Ordering Example

Quantity	Series/Function	Trim Design (Escutcheon Type Only)	Finish	Door Thickness
12	ML2013	N	626	D138

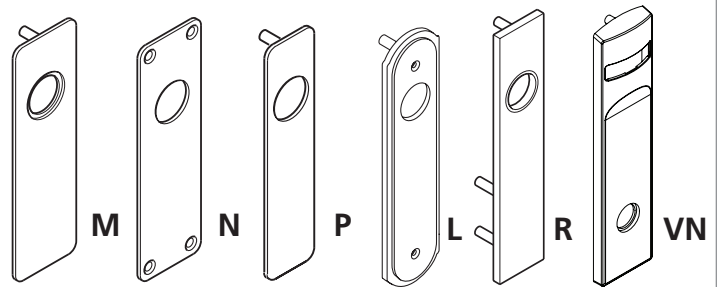

Deadlock No Trim

Function	
613E, 626, BSP, WSP	605, 606, 611, 612, 613, 618, 619, 625, 629, 630, 722

Wrought

M, N, P	
613E, 626, BSP, WSP	605, 606, 611, 612, 613, 618, 619, 625, 629, 630, 722

L, R: Solid Stainless Steel or Forged Brass
VN: Forged Brass

L, R, VN (see note 2)	
613E, 626, BSP, WSP	605, 606, 611, 612, 613, 618, 619, 625, 629, 630, 722

Function	Series	613E, 626, BSP, WSP	605, 606, 611, 612, 613, 618, 619, 625, 629, 630, 722	M, N, P	L, R, VN (see note 2)
Single Cylinder	ML2011	\$420.00	\$426.00	\$476.00	\$548.00
Double Cylinder	ML2012	\$513.00	\$519.00	\$597.00	\$686.00
Cylinder x Thumbturn	ML2013	\$437.00	\$443.00	\$521.00	\$610.00
Classroom Function Cylinder x Thumbturn	ML2017	\$437.00	\$443.00	\$521.00	\$610.00

- NOTES: 1. Escutcheon trims are available for 1 3/8", 1 3/4", or 2 1/4" door thickness only.
2. VN escutcheon available only with indicators. Must be ordered with "V" indicator options. See page 140 for available functions. Option add also applies. Not available with 629 or 630 finish.

Vandal Resistant Trim

Lever Designs: CSV, NSV

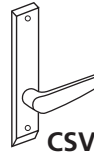

CSV

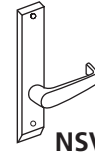

NSV

Lever: Cast
Escutcheon: Cast

Citation



Newport

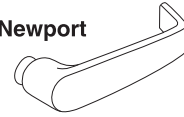

CSV, NSV

630

Function			Price
Non-Keyed	ML2010VR	Passage	\$1,469.00
	ML2020VR	Privacy	\$1,568.00
	ML2030VR		\$1,544.00
	ML2060VR		
	ML2090VR		
Single Cylinder	ML2003VR	Office	\$1,625.00
	ML2051VR	Classroom	
	ML2055VR	Classroom Holdback	
	ML2056VR	Storeroom	
	ML2057VR	Institution Privacy	
	ML2069VR		
	ML2053VR	Entrance	\$1,638.00
	ML2054VR	Entrance	
	ML2058VR	Entrance Holdback	
	ML2068VR		
Single Cylinder with Deadbolt	ML2024VR	Entrance	\$1,661.00
	ML2048VR	Entrance	
	ML2049VR	Security Storeroom	
	ML2059VR	Dormitory	
	ML2065VR	Apartment	
	ML2067VR	Classroom Security	
	ML2073VR	Entrance/Office	
	ML2075VR		
ML2029VR	Hotel	\$1,716.00	
Double Cylinder	ML2002VR	Institution	\$1,718.00
	ML2032VR	Entrance	
	ML2042VR	Classroom Intruder	
	ML2052VR		\$1,754.00
	ML2022VR	Store Door	
	ML2062VR	Intruder Deadbolt	
	ML2072VR	Classroom Security Intruder	
	ML2082VR	Dormitory	
ML2092VR	Security Institution		
Deadlock	ML2011VR	Single Cylinder	\$1,322.00
	ML2013VR	Cylinder x Thumbturn	
	ML2017VR	Double Cylinder	\$1,415.00
	ML2012VR	Double Cylinder	
Full Working Trim (Quick Code M31) No cylinder; includes thumbturn lever			\$1,243.00

NOTE:
Escutcheon trims are available for 1 3/4", 2", or 2 1/4" door thickness only

Mortise Locksets

ML20900 Series Museo Levers and Inspire Roseless Trim

USA & Canada Prices Effective March 16, 2020



contemporary levers to complement the interior design of your next project

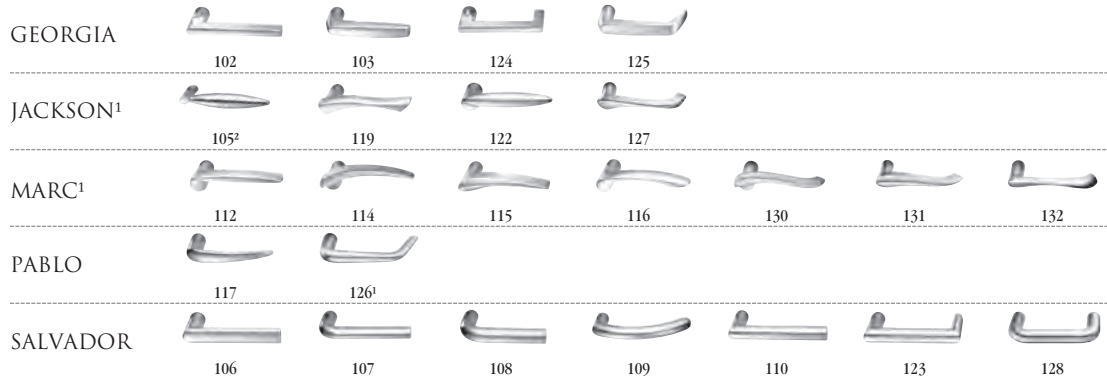

1. Handed: specify hand when ordering
2. Contact factory for current lead time

613E	Dark Oxidized Satin Bronze - Equivalent	605	Bright Brass, Clear Coated	618	Bright Nickel Plated
626	Satin Chromium Plated	606	Satin Brass, Clear Coated	619	Satin Nickel Plated
BSP	Black Suede Powder Coat	611	Bright Bronze, Clear Coated	625	Bright Chromium Plated
WSP	White Suede Powder Coat	612	Satin Bronze, Clear Coated	629*	Bright Stainless Steel
		613	Dark Oxidized Satin Bronze, Oil Rubbed	630*	Satin Stainless Steel
		613L	Dark Oxidized Satin Bronze, Clear Coated	722	Black Oxidized Bronze, Oil Rubbed

Function

Lever with Roses				
Single Cylinder	ML20914	Fail Safe/Fail Secure	\$1,359.00	\$1,383.00
	ML20906			
No Cylinder Override	ML20907	Fail Safe/Fail Secure	\$1,266.00	\$1,290.00
	ML20915			
Double Cylinder	ML20932	Fail Safe/Fail Secure	\$1,452.00	\$1,476.00
	ML20987			



Ordering Example Details

ML2000	ML2051	Office Function
Sectional Trim (rose)	102	Georgia Family Lever
	J	Collar
	625	Finish
	RHR	Handing

Stock Order

Quantity	Series/Function	Trim	Finish	Hand
24	ML2051	102J	625	RHR

*629 and *630 finish options are Not available for all Muséo levers. Please refer to page 24 for availability.



Experience a safer and more open world

Electrically Controlled Mortise Locksets

ML20900 Series: Muséo Levers, Escutcheons, Roses and Thumbturns

USA & Canada Prices Effective March 16, 2020

contemporary levers to complement the interior design of your next project

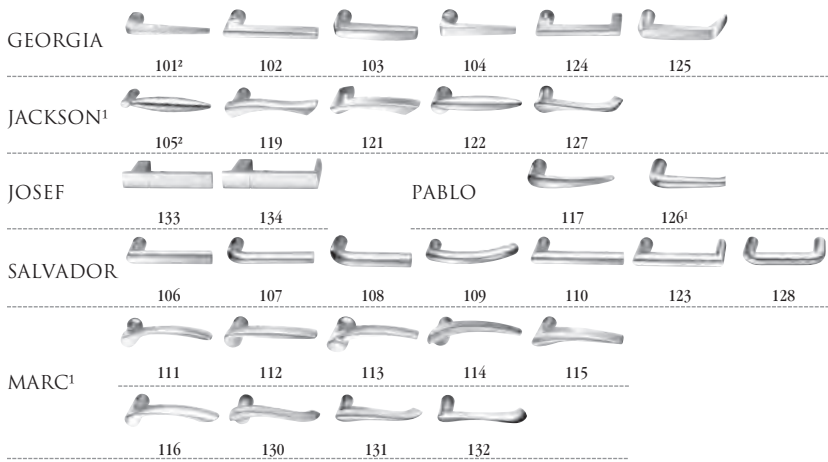

ROSES



ESCUTCHEONS



THUMBTURNS³



1. Handed: specify hand when ordering
2. Contact factory for current lead time
3. Specify thumbturn as quick code. Thumbturn backplate will match shape of rose chosen (i.e. round or square). Not available with escutcheons.
4. ML20987 not available for L or R escutcheons.

*629 and *630 finish options are Not available for all Muséo levers. Please refer to page 24 for availability.

613E	Dark Oxidized Satin Bronze - Equivalent	605	Bright Brass, Clear Coated	618	Bright Nickel Plated
626	Satin Chromium Plated	606	Satin Brass, Clear Coated	619	Satin Nickel Plated
BSP	Black Suede Powder Coat	611	Bright Bronze, Clear Coated	625	Bright Chromium Plated
WSP	White Suede Powder Coat	612	Satin Bronze, Clear Coated	629*	Bright Stainless Steel
		613	Dark Oxidized Satin Bronze, Oil Rubbed	630*	Satin Stainless Steel
		613L	Dark Oxidized Satin Bronze, Clear Coated	722	Black Oxidized Bronze, Oil Rubbed

Function

Lever with Escutcheons: L,R						
Single Cylinder	ML20914	Fail Safe/Fail Secure*	\$1,323.00			\$1,347.00
	ML20906					
No Cylinder Override	ML20907	Fail Safe/Fail Secure*	\$1,230.00			\$1,254.00
	ML20915					
Double Cylinder	ML20932	Fail Safe/Fail Secure*	\$1,416.00			\$1,440.00
	ML20987					
Lever with Roses: V,U,T,Y,X,W,E2,E3,E4						
Single Cylinder	ML20914	Fail Safe/Fail Secure*	\$1,269.00			\$1,293.00
	ML20906					
No Cylinder Override	ML20907	Fail Safe/Fail Secure*	\$1,176.00			\$1,200.00
	ML20915					
Double Cylinder	ML20932	Fail Safe/Fail Secure*	\$1,362.00			\$1,386.00
	ML20987					

*Must specify: SAF for Fail Safe or SEC for Fail Secure.



Ordering Example Details

ML20900 ECL	ML20914	Single Cylinder
Escutcheon Trim	SEC	Fail Secure
	104	Salvador Family Lever
	L	Escutcheon
	613	Finish
	RHR	Handing
	24 AD	24 Volt AC/DC

Stock Order

Quantity	Series/Function	Fail Safe/Fail Secure	Trim	Finish	Hand	Voltage
24	ML20914	SEC	104L	613	RHR	24 AD



Experience a safer and more open world

Electrically Controlled Mortise Locksets

ML20900 Series: Muséo Levers, Escutcheons, Roses and Thumbturns

USA & Canada Prices Effective March 16, 2020



contemporary levers to complement the interior design of your next project



Specify thumbturn as quick code. Thumbturn backplate will match shape of rose chosen (i.e. round or square)

NOTE: ML20987 not available with L or R escutcheons.

613E	Dark Oxidized Satin Bronze – Equivalent
629	Bright Stainless Steel
630	Satin Stainless Steel
BSP	Black Suede Powder Coat
WSP	White Suede Powder Coat

Function

Lever with Escutcheons: L,R			
Single Cylinder	ML20914	Fail Safe/Fail Secure*	\$1,471.00
	ML20906		
No Cylinder Override	ML20907	Fail Safe/Fail Secure*	\$1,378.00
	ML20915		
Double Cylinder	ML20932	Fail Safe/Fail Secure*	\$1,564.00
	ML20987		
Lever with Roses: V,U,T,Y,X,W,E2,E3,E4			
Single Cylinder	ML20914	Fail Safe/Fail Secure*	\$1,398.00
	ML20906		
No Cylinder Override	ML20907	Fail Safe/Fail Secure*	\$1,305.00
	ML20915		
Double Cylinder	ML20932	Fail Safe/Fail Secure*	\$1,491.00
	ML20987		

*Must specify: SAF for Fail Safe or SEC for Fail Secure.

BHMA COMPLIANT
Ordering Example Details

ML20900 ECL	ML20914 Single Cylinder
Escutcheon	SAF Fail Safe
Trim	21M Piet Family Lever - Polished with Satin Insert
	L Escutcheon
	293029 Lever Finish
	Polished with satin stainless steel insert (630), polished stainless steel (629) shank and polished stainless steel (629) grip
	629 Lock Finish
	RHR Handing
	24 AD 24 Volt AC/DC

Stock Order							
Quantity	Series/Function	Fail Safe/Fail Secure	Trim	Lever Finish	Lock Finish	Hand	Voltage
2	ML20914	SAF	21ML	293029	629	RHR	24 AD



Experience a safer and more open world

Electrically Controlled Mortise Locksets

ML20900 Series: *Muséo Levers, Escutcheons, Roses and Thumbturns*

USA & Canada Prices Effective March 16, 2020

contemporary levers to complement the interior design of your next project

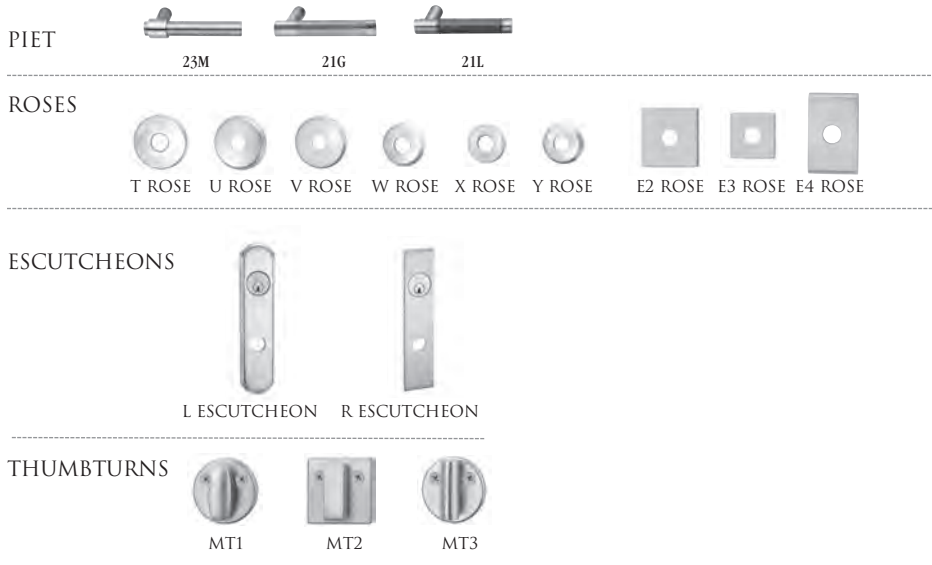

Specify thumbturn as quick code. Thumbturn backplate will match shape of rose chosen (i.e. round or square)

NOTE: ML20987 not available with L or R escutcheons.

613E	Dark Oxidized Satin Bronze – Equivalent
629	Bright Stainless Steel
630	Satin Stainless Steel
BSP	Black Suede Powder Coat
WSP	White Suede Powder Coat

Function

Lever with Escutcheons: L,R			
Single Cylinder	ML20914	Fail Safe/Fail Secure*	\$1,556.00
	ML20906		
No Cylinder Override	ML20907	Fail Safe/Fail Secure*	\$1,463.00
	ML20915		
Double Cylinder	ML20932	Fail Safe/Fail Secure*	\$1,649.00
	ML20987		
Lever with Roses: V,U,T,Y,X,W,E2,E3,E4			
Single Cylinder	ML20914	Fail Safe/Fail Secure*	\$1,483.00
	ML20906		
No Cylinder Override	ML20907	Fail Safe/Fail Secure*	\$1,390.00
	ML20915		
Double Cylinder	ML20932	Fail Safe/Fail Secure*	\$1,576.00
	ML20987		

*Must specify: SAF for Fail Safe or SEC for Fail Secure.

BHMA CERTIFIED		Ordering Example Details
ML20900 ECL	ML20914	Single Cylinder
Escutcheon	SEC	Fail Secure
Trim	23M	Piet Family Lever - Wood Insert
	L	Escutcheon
	29BH29	Lever Finish
		Wood insert with polished stainless steel (629) shank and polished stainless steel (629) grip
	629	Lock Finish
	RHR	Handing
	24 AD	24 Volt AC/DC

Stock Order							
Quantity	Series/Function	Fail Safe/Fail Secure	Trim	Lever Finish	Lock Finish	Hand	Voltage
2	ML20914	SEC	21ML	29BH29	629	RHR	24 AD



Experience a safer and more open world

Electrically Controlled Mortise Locksets

ML20900 Series: Muséo Levers, Escutcheons, Roses and Thumbturns

USA & Canada Prices Effective March 16, 2020

contemporary levers to complement the interior design of your next project

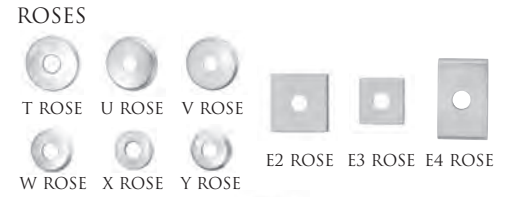
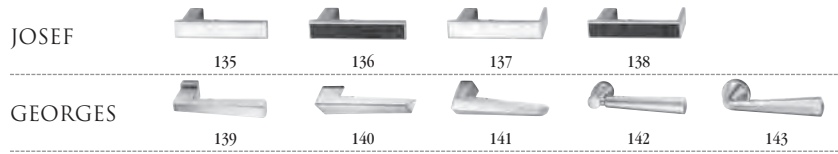

1. Handed: specify hand when ordering
2. Contact factory for current lead time
3. Specify thumbturn as quick code. Thumbturn backplate will match shape of rose chosen (i.e. round or square). Not available with escutcheons.
4. ML20987 not available with L or R escutcheons.

613E	Dark Oxidized Satin Bronze - Equivalent	605	Bright Brass, Clear Coated	618	Bright Nickel Plated
626	Satin Chromium Plated	606	Satin Brass, Clear Coated	619	Satin Nickel Plated
BSP	Black Suede Powder Coat	611	Bright Bronze, Clear Coated	625	Bright Chromium Plated
WSP	White Suede Powder Coat	612	Satin Bronze, Clear Coated	629	Bright Stainless Steel
		613	Dark Oxidized Satin Bronze, Oil Rubbed	630	Satin Stainless Steel
		613L	Dark Oxidized Satin Bronze, Clear Coated	722	Black Oxidized Bronze, Oil Rubbed

Function

Lever with Escutcheons: L,R					
Single Cylinder	ML20914	Fail Safe/Fail Secure*	\$1,532.00		\$1,556.00
	ML20906				
No Cylinder Override	ML20907	Fail Safe/Fail Secure*	\$1,439.00		\$1,463.00
	ML20915				
Double Cylinder	ML20932	Fail Safe/Fail Secure*	\$1,625.00		\$1,649.00
	ML20987				
Lever with Roses: V,U,T,Y,X,W,E2,E3,E4					
Single Cylinder	ML20914	Fail Safe/Fail Secure*	\$1,459.00		\$1,483.00
	ML20906				
No Cylinder Override	ML20907	Fail Safe/Fail Secure*	\$1,366.00		\$1,390.00
	ML20915				
Double Cylinder	ML20932	Fail Safe/Fail Secure*	\$1,552.00		\$1,576.00
	ML20987				

*Must specify: SAF for Fail Safe or SEC for Fail Secure.

Ordering Example Details

ML20900 ECL
Escutcheon Trim

BHMA CERTIFIED
By SAIB, By Secure, By Certified

ML20914	Single Cylinder
SEC	Fail Secure
135	Josef Family Lever
L	Escutcheon
613	Finish
RHR	Handing
24 AD	24 Volt AC/DC

Stock Order

Quantity	Series/Function	Technology Code	Trim	Finish	Hand	Voltage	Fail Safe/Fail Secure	High Security Monitoring Options
24	ML20914	NAC	135L	613	RHR	24 AD	SEC	PHRR01



Experience a safer and more open world

Electrically Controlled Mortise Locksets ML20900 Series

USA & Canada Prices Effective March 16, 2020

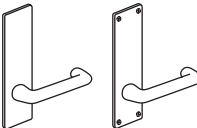
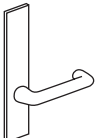
			 LWA RWA Lever: Wrought Rose: Wrought		 LWM LWN Lever: Wrought Escutcheon: Wrought		 LWR Lever: Wrought Escutcheon: Solid Stainless Steel or Forged Brass	
			Levers: LW, RW Roses: A Roses: B, F (see note 1)		Levers: LW, RW Escutcheons: M, N		Levers: LW, RW Escutcheons: R (see note 2)	
Description	Function	Option (See Note 3)	613E, 626, BSP, WSP	605, 606, 611, 612, 613, 618, 619, 625, 629, 630, 722	613E, 626, BSP, WSP	605, 606, 611, 612, 613, 618, 619, 625, 629, 630, 722	613E, 626, BSP, WSP	605, 606, 611, 612, 613, 618, 619, 625, 629, 630, 722
Single Cylinder	ML20914	Fail Safe/Fail Secure	\$1,055.00	\$1,079.00	\$1,075.00	\$1,099.00	\$1,129.00	\$1,153.00
	ML20906							
No Cylinder Override	ML20907	Fail Safe/Fail Secure	\$962.00	\$986.00	\$982.00	\$1,006.00	\$1,036.00	\$1,060.00
	ML20915							
Double Cylinder	ML20932	Fail Safe/Fail Secure	\$1,148.00	\$1,172.00	\$1,168.00	\$1,192.00	\$1,222.00	\$1,246.00
	ML20987						N/A	N/A

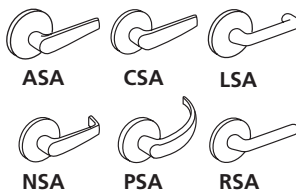
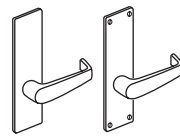
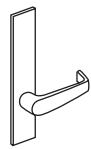
			 ASA CSA LSA NSA PSA RSA Lever: Cast Rose: Wrought			 NSM NSN Lever: Cast Escutcheon: Wrought		 NSR Lever: Cast Escutcheon: Solid Stainless Steel or Forged Brass	
			Levers: AS, CS, LS, NS, PS, RS Roses: A Roses: B, F (see note 1)			Levers: AS, CS, LS, NS, PS, RS Escutcheons: M, N		Levers: AS, CS, LS, NS, PS, RS Escutcheons: R (see note 2)	
Description	Function	Option (See Note 3)	613E, 626, BSP, WSP	605, 606, 611, 612, 613, 618, 619, 625, 629, 630, 722	613E, 626, BSP, WSP	605, 606, 611, 612, 613, 618, 619, 625, 629, 630, 722	613E, 626, BSP, WSP	605, 606, 611, 612, 613, 618, 619, 625, 629, 630, 722	
Single Cylinder	ML20914	Fail Safe/Fail Secure	\$1,241.00	\$1,265.00	\$1,261.00	\$1,285.00	\$1,295.00	\$1,319.00	
	ML20906								
No Cylinder Override	ML20907	Fail Safe/Fail Secure	\$1,148.00	\$1,172.00	\$1,168.00	\$1,192.00	\$1,202.00	\$1,226.00	
	ML20915								
Double Cylinder	ML20932	Fail Safe/Fail Secure	\$1,334.00	\$1,358.00	\$1,354.00	\$1,378.00	\$1,388.00	\$1,412.00	
	ML20987						N/A	N/A	

NOTES:

- 1 - Rose substitutions for LWA, LSA, etc.: 2-1/4" cast rose in place of 2-1/4" wrought rose, substitute letter "B" in place of "A" (e.g. LSB). Add \$38.00 per lockset.
- 2 - 7/8" cast rose in place of 2-1/4" wrought rose, substitute letter "F" in place of "A" (e.g. LWF). Add \$52.00 per lockset.
- 2 - "R" Escutcheon trims are available for 1 3/8", 1 3/4" or 2 1/4" door thickness only.
3. Must Specify: SAF for Fail Safe or SEC for Fail Secure.



ElectroLynx®

As part of their promise to provide innovative, fast and effective high security solutions to their customers, certain ASSA ABLOY Group brands offer *ElectroLynx®*, a universal quick-connect system that simplifies the electrification of the door opening.

Electrically Controlled Mortise Locksets ML20900 Series

USA & Canada Prices Effective March 16, 2020



DSA **ESA**

Lever: Cast
Rose: Wrought

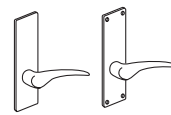

DSM **DSN**

Lever: Cast
Escutcheon: Wrought

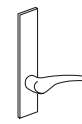

DSR

Lever: Cast
Escutcheon: Solid Stainless Steel
or Forged Brass

Description	Function	Option (See Note 3)	Lever: DS, ES Roses: A Roses: B, F (see note 1)		Lever: DS, ES Escutcheons: M, N		Lever: DS, ES Escutcheons: R (see note 2)	
			613E, 626, BSP, WSP	605, 606, 611, 612, 613, 618, 619, 625, 629, 630, 722	613E, 626, BSP, WSP	605, 606, 611, 612, 613, 618, 619, 625, 629, 630, 722	613E, 626, BSP, WSP	605, 606, 611, 612, 613, 618, 619, 625, 629, 630, 722
Single Cylinder	ML20914	Fail Safe/Fail Secure	\$1,269.00	\$1,293.00	\$1,289.00	\$1,313.00	\$1,323.00	\$1,347.00
	ML20906							
No Cylinder Override	ML20907	Fail Safe/Fail Secure	\$1,176.00	\$1,200.00	\$1,196.00	\$1,220.00	\$1,230.00	\$1,254.00
	ML20915							
Double Cylinder	ML20932	Fail Safe/Fail Secure	\$1,362.00	\$1,386.00	\$1,382.00	\$1,406.00	\$1,416.00	\$1,440.00
	ML20987						N/A	N/A

NOTES:

1 - Rose substitutions for DSA, ESA: 2-1/4" cast rose in place of 2-1/4" wrought rose, substitute letter "B" in place of "A" (e.g. DSB). **Add \$38.00 per lockset.**
2-7/8" cast rose in place of 2-1/4" wrought rose, substitute letter "F" in place of "A" (e.g. ESF). **Add \$52.00 per lockset.**

2 - "R" Escutcheon trims are available for 1 3/8", 1 3/4", or 2 1/4" door thickness only.

3. Must Specify: SAF for Fail Safe or SEC for Fail Secure.

Lever Designs: CSV, NSV

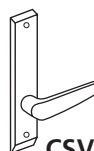

CSV

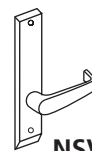

NSV

Lever: Cast
Escutcheon: Cast

Description	Function	Option (See Note 3)	CSV, NSV	
			Finish: 630	
Single Cylinder	ML20914VR	Fail Safe/Fail Secure	\$1,762.00	
	ML20906VR			
No Cylinder Override	ML20907	Fail Safe/Fail Secure	\$1,669.00	
	ML20915			
Double Cylinder	ML20932	Fail Safe/Fail Secure	\$1,855.00	

Note:

Escutcheon trims are available for 1 3/8", 1 3/4", or 2 1/4" door thickness only.

3. Must Specify: SAF for Fail Safe or SEC for Fail Secure.



ElectroLynx®

As part of their promise to provide innovative, fast and effective high security solutions to their customers, certain ASSA ABLOY Group brands offer ElectroLynx®, a universal quick-connect system that simplifies the electrification of the door opening.

Lever Designs: FSG, MSG, ZSG



Frascati



Lever: Rose:
Cast Cast



Vineyard™
collection

Merlot



Lever Designs: FSL, MSL, ZSL



Zinfandel

Lever: Escutcheon:
Cast Cast

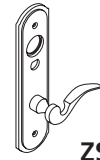
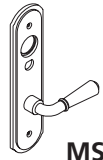

Vineyard™
collection



Description	Function	Option (See Note 3)	FSG, MSG, ZSG		FSL, MSL, ZSL	
			613E, 626, BSP, WSP	605, 606, 611, 612, 613 ² , 613L ² , 618, 619, 625, 722	613E, 626, BSP, WSP	605, 606, 611, 612, 613 ² , 613L ² , 618, 619, 625, 722
Single Cylinder	ML20914	Fail Safe/Fail Secure	\$1,269.00	\$1,293.00	\$1,323.00	\$1,347.00
	ML20906					
No Cylinder Override	ML20907	Fail Safe/Fail Secure	\$1,176.00	\$1,200.00	\$1,230.00	\$1,254.00
	ML20915					
Double Cylinder	ML20932	Fail Safe/Fail Secure	\$1,362.00	\$1,386.00	\$1,416.00	\$1,440.00
	ML20987					

Notes:

- Escutcheon trims are available for 1-3/8", 1-3/4" or 2-1/4" door thicknesses only.
- 613 finish is brass base lever & rose/escutcheon.
- Must Specify: SAF for Fail Safe or SEC for Fail Secure



ElectroLynx®

As part of their promise to provide innovative, fast and effective high security solutions to their customers, certain ASSA ABLOY Group brands offer *ElectroLynx®*, a universal quick-connect system that simplifies the electrification of the door opening.

Electrically Controlled Mortise Locksets ML20900 Series

USA & Canada Prices Effective March 16, 2020

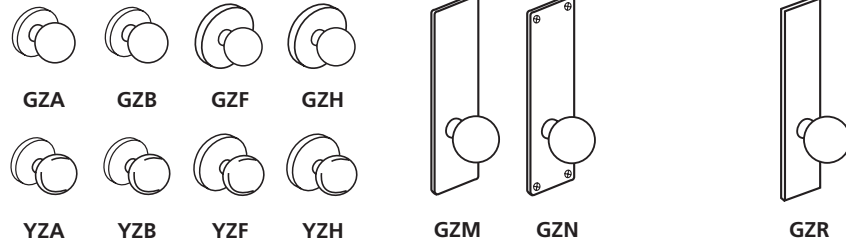

Knob: Solid Cast
Rose: Wrought

Knob: Solid Cast
Escutcheon: Wrought

Knob: Solid Cast
Escutcheon: Solid Stainless
Steel or Forged Brass

Knobs: GZ, YZ	
Roses: A, H	
Roses: B, F (see note 2)	
613E, 626, BSP, WSP	605, 606, 611, 612, 613, 618, 619, 625, 722

Knobs: GZ, YZ	
Escutcheons: M, N	
613E, 626, BSP, WSP	605, 606, 611, 612, 613, 618, 619, 625, 722

Knobs: GZ, YZ	
Escutcheons: R (see note 1)	
613E, 626, BSP, WSP	605, 606, 611, 612, 613, 618, 619, 625, 722

Description	Function	Option (See Note 3)	Knobs: GZ, YZ Roses: A, H Roses: B, F (see note 2)		Knobs: GZ, YZ Escutcheons: M, N		Knobs: GZ, YZ Escutcheons: R (see note 1)	
			613E, 626, BSP, WSP	605, 606, 611, 612, 613, 618, 619, 625, 722	613E, 626, BSP, WSP	605, 606, 611, 612, 613, 618, 619, 625, 722	613E, 626, BSP, WSP	605, 606, 611, 612, 613, 618, 619, 625, 722
Single Cylinder	ML20914	Fail Safe/ Fail Secure	\$1,277.00	\$1,301.00	\$1,297.00	\$1,321.00	\$1,331.00	\$1,355.00
	ML20906							
No Cylinder Override	ML20907	Fail Safe/ Fail Secure	\$1,184.00	\$1,208.00	\$1,204.00	\$1,228.00	\$1,238.00	\$1,262.00
	ML20915							
Double Cylinder	ML20932	Fail Safe/ Fail Secure	\$1,370.00	\$1,394.00	\$1,390.00	\$1,414.00	\$1,424.00	\$1,448.00
	ML20987						N/A	N/A

NOTE 1: "R" Escutcheon trims are available for 1 3/8", 1 3/4", or 2 1/4" door thickness only.

NOTE 2: Rose substitutions: 2-1/4" cast rose in place of 2-1/4" wrought rose, substitute letter "B" in place of "A" (e.g. GZB). **Add \$38.00 per lockset.**
2-7/8" cast rose in place of 2-1/4" wrought rose, substitute letter "F" in place of "A" (e.g. GZF). **Add \$52.00 per lockset.**

NOTE 3: Must Specify: SAF for Fail Safe or SEC for Fail Secure.



ElectroLynx®

As part of their promise to provide innovative, fast and effective high security solutions to their customers, certain ASSA ABLOY Group brands offer *ElectroLynx®*, a universal quick-connect system that simplifies the electrification of the door opening.

Electrically Controlled Mortise Locksets
 ML20600 NAC Series Electrified Mortise Lock with High Security Monitoring

USA & Canada Prices Effective March 16, 2020



contemporary levers to complement the interior design of your next project

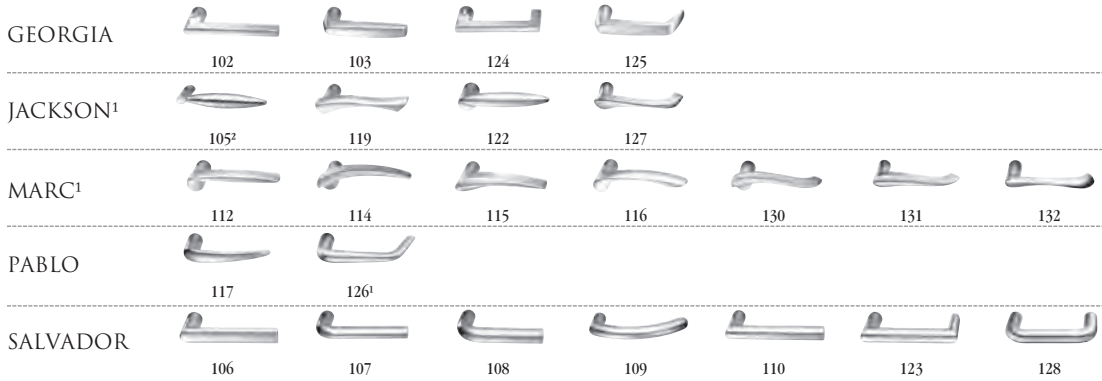

1. Handed: specify hand when ordering
2. Contact factory for current lead time

613E	Dark Oxidized Satin Bronze - Equivalent	605	Bright Brass, Clear Coated	618	Bright Nickel Plated
626	Satin Chromium Plated	606	Satin Brass, Clear Coated	619	Satin Nickel Plated
BSP	Black Suede Powder Coat	611	Bright Bronze, Clear Coated	625	Bright Chromium Plated
WSP	White Suede Powder Coat	612	Satin Bronze, Clear Coated	629*	Bright Stainless Steel
		613	Dark Oxidized Satin Bronze, Oil Rubbed	630*	Satin Stainless Steel
		613L	Dark Oxidized Satin Bronze, Clear Coated	722	Black Oxidized Bronze, Oil Rubbed

Function

Lever with Roses					
Single Cylinder	ML20606 x NAC	Fail Safe/Fail Secure	\$1,534.00		\$1,558.00
	ML20608 x NAC	Fail Safe/Fail Secure	\$1,609.00		\$1,633.00
No Cylinder Override	ML20607 x NAC	Fail Safe/Fail Secure	\$1,441.00		\$1,465.00
	ML20609 x NAC	Fail Safe/Fail Secure	\$1,516.00		\$1,540.00

ML20600 High Security Monitoring Options

Description	Specify	Add or Deduct
Mercury and Lenel compatible 1KΩ/2KΩ resistance supervision	R01	Add \$100.00 per lockset
Software House compatible 1KΩ/2KΩ resistance supervision	R03	Add \$100.00 per lockset
AMAG compatible 4-state supervision	R04	Add \$100.00 per lockset
Deadbolt Privacy Function	PHR	Add \$100.00 per lockset
Deadbolt Privacy and Mercury / Lenel 1KΩ/2KΩ	PHRR01	Add \$200.00 per lockset
Deadbolt Privacy and Software House 1KΩ/2KΩ	PHRR03	Add \$200.00 per lockset
Deadbolt Privacy and AMAG 4-State	PHRR04	Add \$200.00 per lockset



Ordering Example Details →

ML2000 Mortise Lock x NAC x No Cylinder x Deadbolt x Fail-Secure

- Muséo® lever 102 with J Collar
- Polished chrome finish
- Right hand reverse
- Deadbolt privacy function, Mercury and Lenel compatible 1KΩ/2KΩ resistance supervision

Stock Order							
Quantity	Series/Function	Technology Code	Trim	Finish	Hand	Fail Safe/Fail Secure	High Security Monitoring Options
24	ML20608	NAC	102J	625	RHR	SEC	PHRR01

*629 and *630 finish options are Not available for all Muséo levers. Please refer to page 20 for availability.



Experience a safer and more open world

Electrically Controlled Mortise Locksets

ML20600 NAC Series Electrified Mortise Lock with High Security Monitoring

USA & Canada Prices Effective March 16, 2020



contemporary levers to complement the interior design of your next project

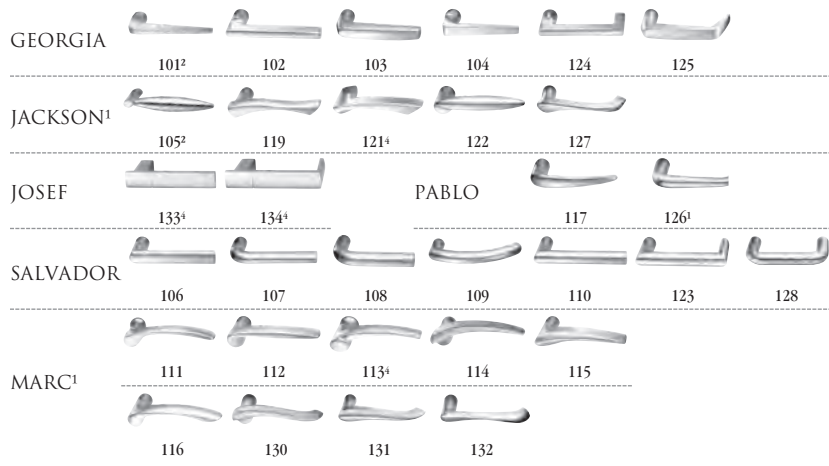

1. Handed: specify hand when ordering
2. Contact factory for current lead time
3. Specify thumbturn as quick code. Thumbturn backplate will match shape of rose chosen (i.e. round or square). Not available with escutcheons.
4. Not available with VN escutcheon.
5. VN escutcheon available only with indicators. Must be ordered with "V" indicator options. See page 140 for available functions. Option add also applies. Not available with 629 or 630 finish.

*629 and *630 finish options are Not available for all Muséo levers. Please refer to page 24 for availability.

Function

Lever with Escutcheons: L,R					
Single Cylinder	ML20606 x NAC	Fail Safe/Fail Secure	\$1,498.00		\$1,522.00
	ML20608 x NAC	Fail Safe/Fail Secure	\$1,573.00		\$1,597.00
No Cylinder Override	ML20607 x NAC	Fail Safe/Fail Secure	\$1,405.00		\$1,429.00
	ML20609 x NAC	Fail Safe/Fail Secure	\$1,480.00		\$1,504.00

Lever with Roses: V,U,T,Y,X,W,E2,E3,E4					
Single Cylinder	ML20606 x NAC	Fail Safe/Fail Secure	\$1,444.00		\$1,468.00
	ML20608 x NAC	Fail Safe/Fail Secure	\$1,519.00		\$1,543.00
No Cylinder Override	ML20607 x NAC	Fail Safe/Fail Secure	\$1,351.00		\$1,375.00
	ML20609 x NAC	Fail Safe/Fail Secure	\$1,426.00		\$1,450.00

*Must specify: SAF for Fail Safe or SEC for Fail Secure.

ML20600 High Security Monitoring Options

Description	Specify	Add or Deduct
Mercury and Lenel compatible 1KΩ/2KΩ resistance supervision	R01	Add \$100.00 per lockset
Software House compatible 1KΩ/2KΩ resistance supervision	R03	Add \$100.00 per lockset
AMAG compatible 4-state supervision	R04	Add \$100.00 per lockset
Deadbolt Privacy Function	PHR	Add \$100.00 per lockset
Deadbolt Privacy and Mercury / Lenel 1KΩ/2KΩ	PHRR01	Add \$200.00 per lockset
Deadbolt Privacy and Software House 1KΩ/2KΩ	PHRR03	Add \$200.00 per lockset
Deadbolt Privacy and AMAG 4-State	PHRR04	Add \$200.00 per lockset

ROSES



ESCUTCHEONS



THUMBTURN^S



613E	Dark Oxidized Satin Bronze - Equivalent	605	Bright Brass, Clear Coated	618	Bright Nickel Plated
626	Satin Chromium Plated	606	Satin Brass, Clear Coated	619	Satin Nickel Plated
BSP	Black Suede Powder Coat	611	Bright Bronze, Clear Coated	625	Bright Chromium Plated
WSP	White Suede Powder Coat	612	Satin Bronze, Clear Coated	629*	Bright Stainless Steel
		613	Dark Oxidized Satin Bronze, Oil Rubbed	630*	Satin Stainless Steel
		613L	Dark Oxidized Satin Bronze, Clear Coated	722	Black Oxidized Bronze, Oil Rubbed



Ordering Example Details

ML20600 NAC	ML20608	Single Cylinder
Escutcheon Trim	SEC	Fail Secure
	104	Salvador Family Lever
	L	Escutcheon
	613	Finish
	RHR	Handing
	24 AD	24 Volt AC/DC

Stock Order

Quantity	Series/Function	Technology Code	Trim	Finish	Hand	Fail Safe/Fail Secure	High Security Monitoring Options
24	ML20608	NAC	104L	613	RHR	SEC	PHRR01



Experience a safer and more open world

Electrically Controlled Mortise Locksets

ML20600 NAC Series Electrified Mortise Lock with High Security Monitoring

USA & Canada Prices Effective March 16, 2020



contemporary levers to complement the interior design of your next project



Specify thumbturn as quick code. Thumbturn backplate will match shape of rose chosen (i.e. round or square)

NOTES:
1. VN escutcheon available only with indicators. Must be ordered with "V" indicator options. See page 140 for available functions. Option add also applies. Not available with 629 or 630 finish.

613E	Dark Oxidized Satin Bronze – Equivalent
629	Bright Stainless Steel
630	Satin Stainless Steel
BSP	Black Suede Powder Coat
WSP	White Suede Powder Coat

Function

Lever with Escutcheons: L,R			
Single Cylinder	ML20606 x NAC	Fail Safe/Fail Secure*	\$1,646.00
	ML20608 x NAC		\$1,721.00
No Cylinder Override	ML20607 x NAC	Fail Safe/Fail Secure*	\$1,553.00
	ML20609 x NAC		\$1,628.00
Lever with Roses: V,U,T,Y,X,W,E2,E3,E4			
Single Cylinder	ML20606 x NAC	Fail Safe/Fail Secure*	\$1,573.00
	ML20608 x NAC		\$1,648.00
No Cylinder Override	ML20607 x NAC	Fail Safe/Fail Secure*	\$1,480.00
	ML20609 x NAC		\$1,555.00

ML20600 High Security Monitoring Options

Description	Specify	Add or Deduct
Mercury and Lenel compatible 1KΩ/2KΩ resistance supervision	R01	Add \$100.00 per lockset
Software House compatible 1KΩ/2KΩ resistance supervision	R03	Add \$100.00 per lockset
AMAG compatible 4-state supervision	R04	Add \$100.00 per lockset
Deadbolt Privacy Function	PHR	Add \$100.00 per lockset
Deadbolt Privacy and Mercury / Lenel 1KΩ/2KΩ	PHRR01	Add \$200.00 per lockset
Deadbolt Privacy and Software House 1KΩ/2KΩ	PHRR03	Add \$200.00 per lockset
Deadbolt Privacy and AMAG 4-State	PHRR04	Add \$200.00 per lockset

*Must specify: SAF for Fail Safe or SEC for Fail Secure.

Ordering Example Details

ML20600 NAC ML20914 Single Cylinder
 Escutcheon SEC Fail Secure
 Trim 23M Piet Family Lever - Wood Insert
 L Escutcheon
 29BH29 Lever Finish Wood insert with polished stainless steel (629) shank and polished stainless steel (629) grip
 629 Lock Finish
 RHR Handing
 24 AD 24 Volt AC/DC

Stock Order									
Qty	Series/Function	Tech. Code	Trim	Lever Finish	Finish	Hand	Voltage	Fail Safe/Fail Secure	High Security Monitoring Options
2	ML20608	NAC	21ML	29BH29	629	RHR	24 AD	SEC	PHRR01



Experience a safer and more open world

Electrically Controlled Mortise Locksets

ML20600 NAC Series Electrified Mortise Lock with High Security Monitoring

USA & Canada Prices Effective March 16, 2020



contemporary levers to complement the interior design of your next project

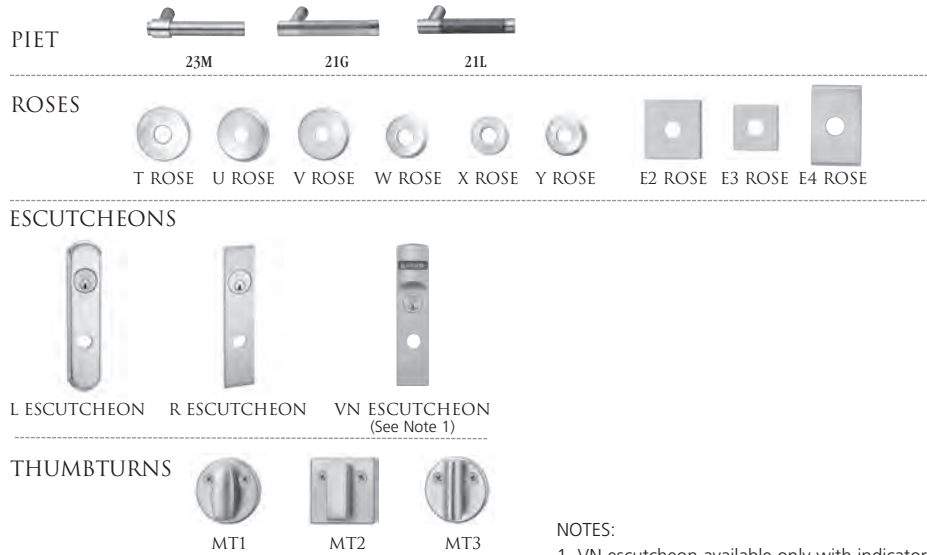

Specify thumbturn as quick code. Thumbturn backplate will match shape of rose chosen (i.e. round or square)

NOTES:

1. VN escutcheon available only with indicators. Must be ordered with "V" indicator options. See page 140 for available functions. Option add also applies. Not available with 629 or 630 finish.

613E	Dark Oxidized Satin Bronze – Equivalent
629	Bright Stainless Steel
630	Satin Stainless Steel
BSP	Black Suede Powder Coat
WSP	White Suede Powder Coat

Function

Lever with Escutcheons: L,R			
Single Cylinder	ML20606 x NAC	Fail Safe/Fail Secure*	\$1,731.00
	ML20608 x NAC		\$1,806.00
No Cylinder Override	ML20607 x NAC	Fail Safe/Fail Secure*	\$1,638.00
	ML20609 x NAC		\$1,713.00
Lever with Roses: V,U,T,Y,X,W,E2,E3,E4			
Single Cylinder	ML20606 x NAC	Fail Safe/Fail Secure*	\$1,658.00
	ML20608 x NAC		\$1,733.00
No Cylinder Override	ML20607 x NAC	Fail Safe/Fail Secure*	\$1,565.00
	ML20609 x NAC		\$1,640.00

ML20600 High Security Monitoring Options

Description	Specify	Add or Deduct
Mercury and Lenel compatible 1KΩ/2KΩ resistance supervision	R01	Add \$100.00 per lockset
Software House compatible 1KΩ/2KΩ resistance supervision	R03	Add \$100.00 per lockset
AMAG compatible 4-state supervision	R04	Add \$100.00 per lockset
Deadbolt Privacy Function	PHR	Add \$100.00 per lockset
Deadbolt Privacy and Mercury / Lenel 1KΩ/2KΩ	PHRR01	Add \$200.00 per lockset
Deadbolt Privacy and Software House 1KΩ/2KΩ	PHRR03	Add \$200.00 per lockset
Deadbolt Privacy and AMAG 4-State	PHRR04	Add \$200.00 per lockset

*Must specify: SAF for Fail Safe or SEC for Fail Secure.

Ordering Example Details

BHMA CORBINSWISS	ML20600 NAC	ML20608 Single Cylinder
	Escutcheon Trim	SEC Fail Secure
	23M	Piet Family Lever - Wood
	Insert	
	L	Escutcheon
	29BH29	Lever Finish
		Wood insert with polished stainless steel (629)
		shank and polished stainless steel (629) grip
	629	Lock Finish
	RHR	Handing
	24 AD	24 Volt AC/DC

Stock Order

Qty	Series/Function	Tech. Code	Trim	Lever Finish	Finish	Hand	Voltage	Fail Safe/Fail Secure	High Security Monitoring Options
2	ML20608	NAC	21ML	29BH29	629	RHR	24 AD	SEC	PHRR01



Experience a safer and more open world

Electrically Controlled Mortise Locksets

ML20600 NAC Series Electrified Mortise Lock with High Security Monitoring

USA & Canada Prices Effective March 16, 2020

contemporary levers to complement the interior design of your next project



JOSEF



GEORGES



ROSES



ESCUTCHEONS



THUMBTURNS³



1. Handed: specify hand when ordering.
2. Contact factory for current lead time.
3. Specify thumbturn as quick code. Thumbturn backplate will match shape of rose chosen (i.e. round or square).
Not available with escutcheons.
4. Not available with escutcheon indicators.

613E	Dark Oxidized Satin Bronze - Equivalent	605	Bright Brass, Clear Coated	618	Bright Nickel Plated
626	Satin Chromium Plated	606	Satin Brass, Clear Coated	619	Satin Nickel Plated
BSP	Black Suede Powder Coat	611	Bright Bronze, Clear Coated	625	Bright Chromium Plated
WSP	White Suede Powder Coat	612	Satin Bronze, Clear Coated	629	Bright Stainless Steel
		613	Dark Oxidized Satin Bronze, Oil Rubbed	630	Satin Stainless Steel
		613L	Dark Oxidized Satin Bronze, Clear Coated	722	Black Oxidized Bronze, Oil Rubbed

Function

Lever with Escutcheons: L,R					
Single Cylinder	ML20606 x NAC	Fail Safe/Fail Secure	\$1,707.00		\$1,731.00
	ML20608 x NAC	Fail Safe/Fail Secure	\$1,782.00		\$1,806.00
No Cylinder Override	ML20607 x NAC	Fail Safe/Fail Secure	\$1,614.00		\$1,638.00
	ML20609 x NAC	Fail Safe/Fail Secure	\$1,689.00		\$1,713.00

Lever with Roses: V,U,T,Y,X,W,E2,E3,E4					
Single Cylinder	ML20606 x NAC	Fail Safe/Fail Secure	\$1,634.00		\$1,658.00
	ML20608 x NAC	Fail Safe/Fail Secure	\$1,709.00		\$1,733.00
No Cylinder Override	ML20607 x NAC	Fail Safe/Fail Secure	\$1,631.00		\$1,655.00
	ML20609 x NAC	Fail Safe/Fail Secure	\$1,706.00		\$1,730.00

*Must specify: SAF for Fail Safe or SEC for Fail Secure.

ML20600 High Security Monitoring Options

Description	Specify	Add or Deduct
Mercury and Lenel compatible 1KΩ/2KΩ resistance supervision	R01	Add \$100.00 per lockset
Software House compatible 1KΩ/2KΩ resistance supervision	R03	Add \$100.00 per lockset
AMAG compatible 4-state supervision	R04	Add \$100.00 per lockset
Deadbolt Privacy Function	PHR	Add \$100.00 per lockset
Deadbolt Privacy and Mercury / Lenel 1KΩ/2KΩ	PHRR01	Add \$200.00 per lockset
Deadbolt Privacy and Software House 1KΩ/2KΩ	PHRR03	Add \$200.00 per lockset
Deadbolt Privacy and AMAG 4-State	PHRR04	Add \$200.00 per lockset

BHMA CERTIFIED	Ordering Example Details
ML20600 NAC	ML20608 Single Cylinder
Escutcheon Trim	SEC Fail Secure
	104 Salvador Family Lever
	L Escutcheon
	613 Finish
	RHR Handing
	24 AD 24 Volt AC/DC

Stock Order							
Quantity	Series/Function	Technology Code	Trim	Finish	Hand	Fail Safe/Fail Secure	High Security Monitoring Options
24	ML20608	NAC	135L	613	RHR	SEC	PHRR01



Experience a safer and more open world

Electrified Mortise Lock with High Security Monitoring ML20600 Series NAC

USA & Canada Prices Effective March 16, 2020

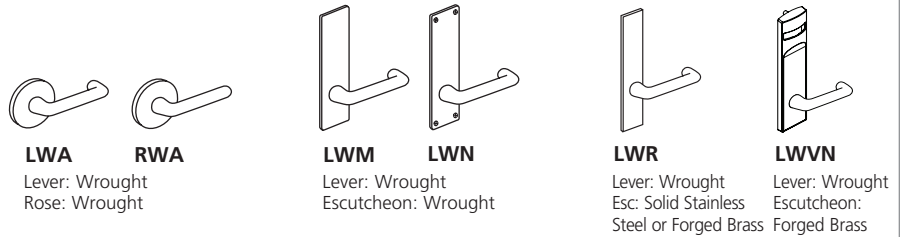

Description	Function	Option (See Note 3)	Levers: LW, RW Roses: A Roses: B, F (see note 1)		Levers: LW, RW Escutcheons: M, N		Levers: LW, RW Escutcheons: R (see note 2) VN (see note 4)	
			613E, 626, BSP, WSP	605, 606, 611, 612, 613, 618, 619, 625, 629, 630, 722	613E, 626, BSP, WSP	605, 606, 611, 612, 613, 618, 619, 625, 629, 630, 722	613E, 626, BSP, WSP	605, 606, 611, 612, 613, 618, 619, 625, 629, 630, 722
Single Cylinder	ML20606 x NAC	Fail Safe/Fail Secure	\$1,230.00	\$1,254.00	\$1,250.00	\$1,274.00	\$1,304.00	\$1,328.00
	ML20608 x NAC		\$1,305.00	\$1,329.00	\$1,325.00	\$1,349.00	\$1,379.00	\$1,403.00
No Cylinder Override	ML20607 x NAC	Fail Safe/Fail Secure	\$1,137.00	\$1,161.00	\$1,157.00	\$1,181.00	\$1,211.00	\$1,235.00
	ML20609 x NAC		\$1,212.00	\$1,236.00	\$1,232.00	\$1,256.00	\$1,286.00	\$1,310.00



Description	Function	Option (See Note 3)	Levers: AS, CS, LS, NS, PS, RS Roses: A Roses: B, F (see note 1)		Levers: AS, CS, LS, NS, PS, RS Escutcheons: M, N		Levers: AS, CS, LS, NS, PS, RS Escutcheons: R (see note 2) VN (see note 4)	
			613E, 626, BSP, WSP	605, 606, 611, 612, 613, 618, 619, 625, 629, 630, 722	613E, 626, BSP, WSP	605, 606, 611, 612, 613, 618, 619, 625, 629, 630, 722	613E, 626, BSP, WSP	605, 606, 611, 612, 613, 618, 619, 625, 629, 630, 722
Single Cylinder	ML20606 x NAC	Fail Safe/Fail Secure	\$1,416.00	\$1,440.00	\$1,436.00	\$1,460.00	\$1,470.00	\$1,494.00
	ML20608 x NAC		\$1,491.00	\$1,515.00	\$1,511.00	\$1,535.00	\$1,545.00	\$1,569.00
No Cylinder Override	ML20607 x NAC	Fail Safe/Fail Secure	\$1,323.00	\$1,347.00	\$1,343.00	\$1,367.00	\$1,377.00	\$1,401.00
	ML20609 x NAC		\$1,398.00	\$1,422.00	\$1,418.00	\$1,442.00	\$1,452.00	\$1,476.00

- NOTES:
- Rose substitutions for LWA, LSA, etc.: 2-1/4" cast rose in place of 2-1/4" wrought rose, substitute letter "B" in place of "A" (e.g. LSB). **Add \$40.00 per lockset.** 2-7/8" cast rose in place of 2-1/4" wrought rose, substitute letter "F" in place of "A" (e.g. LWF). **Add \$54.00 per lockset.**
 - "R" Escutcheon trims are available for 1 3/8", 1 3/4" or 2 1/4" door thickness only.
 - Must Specify: SAF for Fail Safe or SEC for Fail Secure.
 - VN escutcheon available only with indicators. Must be ordered with "V" indicator options. See page 140 for available functions. Option add also applies. Not available with 629 or 630 finish.



ElectroLynx®

As part of their promise to provide innovative, fast and effective high security solutions to their customers, certain ASSA ABLOY Group brands offer *ElectroLynx®*, a universal quick-connect system that simplifies the electrification of the door opening.

Electrified Mortise Lock with High Security Monitoring ML20600 Series NAC

USA & Canada Prices Effective March 16, 2020



DSA **ESA**
Lever: Cast
Rose: Wrought

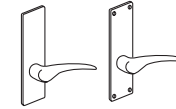

DSM **DSN**
Lever: Cast
Escutcheon: Wrought

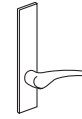

DSR
Lever: Cast
Esc: Solid Stainless
Steel or Forged Brass

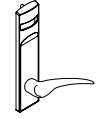

DSVN
Lever: Cast
Escutcheon:
Forged Brass

Description	Function	Option (See Note 3)	Lever: DS, ES Roses: A Roses: B, F (see note 1)		Lever: DS, ES Escutcheons: M, N		Lever: DS, ES Escutcheons: R (see note 2) VN (see note 4)	
			613E, 626, BSP, WSP	605, 606, 611, 612, 613, 618, 619, 625, 629, 630, 722	613E, 626, BSP, WSP	605, 606, 611, 612, 613, 618, 619, 625, 629, 630, 722	613E, 626, BSP, WSP	605, 606, 611, 612, 613, 618, 619, 625, 629, 630, 722
Single Cylinder	ML20606 x NAC	Fail Safe/Fail Secure	\$1,444.00	\$1,468.00	\$1,464.00	\$1,488.00	\$1,498.00	\$1,522.00
	ML20608 x NAC		\$1,519.00	\$1,543.00	\$1,539.00	\$1,563.00	\$1,573.00	\$1,597.00
No Cylinder Override	ML20607 x NAC	Fail Safe/Fail Secure	\$1,351.00	\$1,375.00	\$1,371.00	\$1,395.00	\$1,405.00	\$1,429.00
	ML20609 x NAC		\$1,426.00	\$1,450.00	\$1,446.00	\$1,470.00	\$1,480.00	\$1,504.00

NOTES: 1. Rose substitutions for DSA, ESA: 2-1/4" cast rose in place of 2-1/4" wrought rose, substitute letter "B" in place of "A" (e.g.DSB). **Add \$40.00 per lockset.**
2-7/8" cast rose in place of 2-1/4" wrought rose, substitute letter "F" in place of "A" (e.g. ESF). **Add \$54.00 per lockset.**
2. "R" Escutcheon trims are available for 1 3/8", 1 3/4", or 2 1/4" door thickness only.
3. Must Specify: SAF for Fail Safe or SEC for Fail Secure.
4. VN escutcheon available only with indicators. Must be ordered with "V" indicator options. See page 140 for available functions.
Option add also applies. Not available with 629 or 630 finish.

Lever Designs: CSV, NSV

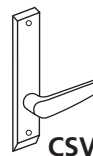

CSV

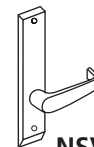

NSV

Lever: Cast
Escutcheon: Cast

Description	Function	Option (See Note 3)	CSV, NSV	
			Finish: 630	
Single Cylinder	ML20606VR x NAC	Fail Safe/Fail Secure	\$1,937.00	
	ML20608VR x NAC		\$2,012.00	
No Cylinder Override	ML20607 x NAC	Fail Safe/Fail Secure	\$1,844.00	
	ML20609 x NAC		\$1,919.00	

Note:
Escutcheon trims are available for 1 3/8", 1 3/4", or 2 1/4" door thickness only.
3. Must Specify: SAF for Fail Safe or SEC for Fail Secure.



ElectroLynx®

As part of their promise to provide innovative, fast and effective high security solutions to their customers, certain ASSA ABLOY Group brands offer ElectroLynx®, a universal quick-connect system that simplifies the electrification of the door opening.

Electrified Mortise Lock with High Security Monitoring ML20600 Series NAC

USA & Canada Prices Effective March 16, 2020

Lever Designs: FSG, MSG, ZSG



Frascati



Lever: Rose:
Cast Cast



Merlot



Lever Designs: FSL, MSL, ZSL, FSVN, MSVN, ZSVN



Zinfandel



Lever: Escutcheon:
Cast Cast

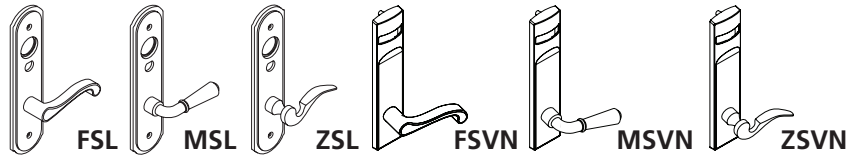

Description	Function	Option (See Note 3)	FSG, MSG, ZSG		FSL, MSL, ZSL FSVN, MSVN, ZSVN (see note 4)	
			Finish: 613E, 626, BSP, WSP	Finish: 605, 606, 611, 612, 613 ² , 613L ² , 618, 619, 625, 722	613E, 626, BSP, WSP	Finish: 605, 606, 611, 612, 613 ² , 613L ² , 618, 619, 625, 722
Single Cylinder	ML20606 x NAC	Fail Safe/Fail Secure	\$1,444.00	\$1,468.00	\$1,498.00	\$1,522.00
	ML20608 x NAC		\$1,519.00	\$1,543.00	\$1,573.00	\$1,597.00
No Cylinder Override	ML20607 x NAC	Fail Safe/Fail Secure	\$1,351.00	\$1,375.00	\$1,405.00	\$1,429.00
	ML20609 x NAC		\$1,426.00	\$1,450.00	\$1,480.00	\$1,504.00

- NOTES: 1. Escutcheon trims are available for 1-3/8", 1-3/4" or 2-1/4" door thicknesses only.
 2. 613 finish is brass base lever & rose/escutcheon.
 3. Must Specify: SAF for Fail Safe or SEC for Fail Secure.
 4. VN escutcheon available only with indicators. Must be ordered with "V" indicator options. See page 140 for available functions. Option add also applies.



ElectroLynx®

As part of their promise to provide innovative, fast and effective high security solutions to their customers, certain ASSA ABLOY Group brands offer *ElectroLynx®*, a universal quick-connect system that simplifies the electrification of the door opening.

Fail Safe/Fail Secure

Description	Specify Quick Code
Fail Safe	SAF
Fail Secure	SEC

Electrified Options for ML20900

Description	Specify Quick Code	Add or Deduct
Latchbolt Monitor	M91	\$205.00
Request to Exit (REX)	M92	\$202.00
Security monitor	M105	\$355.00
Latchbolt monitor x request to exit	M91 x M92	\$407.00
Request to Exit x security monitor	M92 x M105	\$557.00

Accessories

Part No.	Description	Add or Deduct
BPS-24-1	Power Supply 24V 1 AMP	\$355.00
BPS-12-1	Power Supply 12V 1 AMP	
BPS-24-2	Power Supply 24V 2 AMP	\$722.00
BPS-12-3	Power Supply 12V 3 AMP	

ML20600 High Security Monitoring Options

EcoFlex® Mortise Lock End-of-Line Resistors and Deadbolt Privacy Options

Description	Specify Quick Code	Add or Deduct
Mercury and Lenel compatible 1KΩ/2KΩ resistance supervision	R01	Add \$100.00 per lockset
Software House compatible 1KΩ/2KΩ resistance supervision	R03	Add \$100.00 per lockset
AMAG compatible 4-state supervision	R04	Add \$100.00 per lockset
Deadbolt Privacy Function	PHR	Add \$100.00 per lockset
Deadbolt Privacy and Mercury / Lenel 1KΩ/2KΩ	PHRR01	Add \$200.00 per lockset
Deadbolt Privacy and Software House 1KΩ/2KΩ	PHRR03	Add \$200.00 per lockset
Deadbolt Privacy and AMAG 4-State	PHRR04	Add \$200.00 per lockset



ElectroLynx®

As part of their promise to provide innovative, fast and effective high security solutions to their customers, certain ASSA ABLOY Group brands offer *ElectroLynx*®, a universal quick-connect system that simplifies the electrification of the door opening.

Lock Only

Includes lockcase, armored front, strike and screw pack. Cylinder(s) and thumbturn lever are not included.

Ordering Example

Quantity	Series/Function	Trim See Key Below	Finish	Door Thickness	Optional Strike
12	ML2055	LL	626	D138	SS078

Trim Key					
KK	Knob x Knob	LK	Lever x Knob	HL	Lever Inside only
LL	Lever x Lever	KL	Knob x Lever	HK	Knob inside Only

Function	Description	LL, LK, KL, HL, HK ² , KK ²		
		Available in all listed mortise trim finishes		
Non-Keyed	ML2010	Passage	\$403.00	
	ML2020	Privacy	\$477.00	
	ML2030	Privacy		
	ML2060	Privacy		
Single Cylinder	ML2051	Office	\$441.00	
	ML2003	Classroom	\$454.00	
	ML2053	Entrance		
	ML2054	Entrance		
	ML2055	Classroom	\$441.00	
	ML2056	Classroom Holdback		
	ML2057	Storeroom		
	ML2058	Entrance Holdback	\$454.00	
	ML2068	Privacy and Apartment	\$441.00	
ML2069	Institution Privacy			
Single Cylinder with Deadbolt	ML2024	Entrance	\$477.00	
	ML2048	Entrance		
	ML2059	Security Storeroom		
	ML2065	Dormitory		
	ML2067	Apartment		
	ML2073	Classroom Security		
	ML2075	Entrance/Office		
	ML2029	Hotel	\$486.00	
Double Cylinder	ML2002	Classroom Intruder	\$441.00	
	ML2022	Store Door		
	ML2032	Institution		
	ML2042	Entrance		
	ML2052	Classroom Intruder		
	ML2062	Intruder Deadbolt		
	ML2072	Classroom Security Intruder		
	ML2082	Dormitory		
	ML2087	Security Institution		
	ML2092	Security Institution		
Single Cylinder	ML20914	Fail Safe/Fail Secure	\$659.00	
	ML20906			
No Cylinder Override	ML20907	Fail Safe/Fail Secure		
	ML20915			
Double Cylinder	ML20932	Fail Safe/Fail Secure		
	ML20987	Security Vestibule		
No Cylinder Override	ML20833	Without key override		\$809.00
Single Cylinder	ML20834	With key override		
Deadbolt without key override	ML20835	Deadbolt without key override		
Single Cylinder with deadbolt	ML20836	Deadbolt with key override		

Notes: 1. Kits contain internal lock parts only. Order knobs, spindles, escutcheons, cylinders and collars separately.
 2. For master ring, specify quick code MR-LC. Add \$20.00. Not available for ML20900 series.

Cylinder & Keying Options

Description	Specify Quick Code	Add or Deduct
Conventional 6-pin	(standard)	No Charge
Conventional 7-pin	7P	Add \$2.00 per cylinder
Less Standard Cylinder	LC	Deduct \$93.00 per cylinder
Less Hotel Cylinder	LC	Deduct \$130.00 per cylinder
Less Master Ring Cylinder ³	MR-LC	Deduct \$40.00 per cylinder
Less Concealed Shell Cylinder	PO-LC	Add \$5.00 per lockset
Access 3 Patented	AP	No Charge
Access 3 Security	AS	Add \$61.00 per cylinder
Access 3 High Security, UL 437	AHS	Add \$86.00 per cylinder
Access 3 IC Patented	ACP	Add \$80.00 per cylinder
Access 3 IC Security	ACS	Add \$132.00 per cylinder
Access 3 IC High Security, UL 437	ACHS	Add \$153.00 per cylinder
Pyramid Security Fixed Core ²	PS	Add \$64.00 per cylinder
Pyramid Security IC ²	PCS	Add \$140.00 per cylinder
Pyramid High Security Fixed Core ²	PHS	Add \$96.00 per cylinder
Pyramid High Security IC ²	PCHS	Add \$171.00 per cylinder
Pyramid IC with Temporary Construction Core ^{2,4}	CTP	Add \$80.00 per cylinder
Pyramid IC with Temporary Disposable Core ^{2,4}	CTPD	No Charge
Pyramid IC Less Core ²	CLP	No Charge
Security ⁵	HS	Add \$121.00 per cylinder
Security IC ^{1,5}	CHS	Add \$199.00 per cylinder
IC 6-pin	C6	Add \$80.00 per cylinder
IC 6-pin with Temporary Construction Core (Red)	CT6R	Add \$80.00 per cylinder
IC 6-pin with Temporary Construction Core (Blue)	CT6B	Add \$80.00 per cylinder
IC 6-pin with Temporary Construction Core (Green)	CT6G	Add \$80.00 per cylinder
IC 6-pin with Temporary Disposable Core	CT6D	No Charge
IC 6-pin Less Core	CL6	No Charge
SFIC 6-pin with Less Core ²	CLS6	No Charge
IC 6-pin with SFIC disposable temporary core ²	CT6SD	No Charge
IC 7-pin ²	C7	Add \$82.00 per cylinder
IC 7-pin with Temporary Construction Core (Red) ²	CT7R	Add \$82.00 per cylinder
IC 7-pin with Temporary Construction Core (Blue) ²	CT7B	Add \$82.00 per cylinder
IC 7-pin with Temporary Construction Core (Green) ²	CT7G	Add \$82.00 per cylinder
IC 7-pin with Temporary Disposable Core ²	CT7D	Add \$2.00 per cylinder
IC 7-pin Less Core ²	CL7	Add \$2.00 per cylinder
SFIC 7-pin with Less Core ²	CLS7	Add \$2.00 per cylinder
IC 7-pin with SFIC disposable temporary core ²	CT7SD	Add \$2.00 per cylinder
Master Ring ³	MR	Add \$72.00 per cylinder
Flex Head Cylinder, 6-pin (sectional trim)	FX6	Add \$79.00 per cylinder
Flex Head Cylinder, 7-pin (sectional trim)	FX7	Add \$81.00 per cylinder
Flex Head Master Ring (sectional trim)	FXM	Add \$130.00 per cylinder
Plug only to show, 6-pin (concealed shell) (available for M and R escutcheons and single cylinder functions only)	P06	Add \$96.00 per lockset
Plug only to show, 7-pin (concealed shell) (available for M and R escutcheons and single cylinder functions only)	P07	Add \$98.00 per lockset
Laser Engraving	LASER	Add \$20.00 per lockset

Notes:

1. CHS ordered with CT6 option no charge.
2. Pyramid series and IC-7 pin are not available in ML2029 function.
3. Available for "M" escutcheon and sectional trim only. Not available for 17, 29 or 32 functions, and ECL functions. Not available for ML20900 series.
4. Refer to Key construction core program, pg. 63 for example of CTP option pricing.
5. For existing systems only.

Cylinder & Keying Options* (con't)

Description	Specify Quick Code	Add or Deduct
0-Bitted with two blank keys ⁵	(standard)	No Charge
Keyed Random ⁴	KR	No Charge
Master keyed (all cylinders except 8000, 8020, 8027 IC core)	specify keyset	Add \$16.00 per cylinder
Master keyed Pyramid	specify keyset	Add \$16.00 per cylinder
Master keyed Security (including IC cylinder and core)	specify keyset	Add \$16.00 per cylinder
Master keyed (8000, 8020, 8027 IC core)	specify keyset	No Charge
Master keyed to customer bittings or sample key	specify keyset	Add \$16.00 per cylinder
Construction master keyed ^{1,2}	CMK	Add \$16.00 per cylinder
Visual key control (VKC)		
- No Stamping	VKC0	\$4.50
- Keys only	VKC1	No Charge
- Cylinders and Keys ³	VKC2	\$8.00
- Cylinders only ³	VKC3	\$8.00
Concealed key control (CKC)		
- CKC cylinders with VKC keys	CKC2	\$8.00
- CKC cylinders only ³	CKC3	\$8.00
More than 2 keys per lock	KY# (e.g., KY6)	See page 31 - Cut Keys Section

*Double Cylinder Keying: Unless otherwise specified, both cylinders of ML2012, 2022, 2032, 2052, 2062, 2072, 2082, 2092 function locks will be keyed alike. The inside cylinder of 42 function locks will be keyed to the master key(s) only, while the outside cylinder will include the change key. If different is required, specify outside cylinder first, then inside cylinder. For key bows other than 10 and 90, specify "KB" + bow number as Quick Code, e.g. KB12. No extra charge.

Notes:

1. CMK Construction master keying charge is in addition to master keying charge.
2. CMK Construction master keying is not available in interchangeable core, Access 3, Pyramid, or Security series.
3. VKC2, VKC3, CKC3 are not available in Pyramid or Security series.
4. Pyramid series is not available keyed random.
5. Security series is not available 0-bitted.

Strike Options*

(To purchase strike separately, see catalog or parts manual for part no.)

Lip Length	ANSI Straight Lip - Specify Quick Code	ANSI Curved Lip - Specify Quick Code	Add or Deduct
7/8"	SS078	N/A	No Charge
1-1/8"	(standard)	N/A	
1-1/4"	SS114	SA114	
1-3/8"	SS138	SA138	
1-1/2"	SS112	SA112	
1-3/4"	SS134	SA134	
2"	SS200	SA200	Add \$17.00 per lockset
2-1/4"	SS214	SA214	
2-1/2"	SS212	SA212	
2-3/4"	SS234	SA234	
3"	SS300	SA300	

Description	Door Thickness	Specify Quick Code	Add or Deduct
Open Back Strike	1-3/4"	SB134	Add \$86.00 per lockset
Open Back Strike	2"	SB200	Add \$130.00 per lockset
Open Back Strike	2-1/4"	SB214	
Rabbeted front and strike		SR118	Add \$90.00 per lockset

* If door thickness is standard or has been specified and no special door or frame condition exist, then only the first two characters of the optional strike Quick Code must be specified (e.g. "SA").
The correct lip length will be determined by our order entry system based on the standard or specified door thickness.

Door Thickness with Locksets Mortised on Center

(Note: Door thickness with panel not to exceed 2" from centerline of lock.)

Door Thickness	Sectional Rose Trim Specify Quick Code	Escutcheon ^{1,2} Trim Specify Quick Code	Add or Deduct
1-3/4" (standard)	—	—	No Charge
1-3/8"	D138	D138	Add \$56
1-7/8"	D178	N/A	No Charge
2"	D200	D200	
2-1/8"	D218	N/A	
2-1/4"	D214	D214	
2-3/8"	D238	D238	Add \$92.00 per lockset
2-1/2"	D212	D212	
2-5/8"	D258	D258	
2-3/4"	D234	D234	
2-7/8"	D278	D278	
3"	D300	D300	
3-1/8"	D318	D318	
3-1/4"	D314	D314	
3-3/8"	D338	D338	
3-1/2"	D312	D312	
3-5/8"	D358	D358	
3-3/4"	D334	D334	
3-7/8"	D378	D378	
4"	D400	D400	

Notes:

- For 2-3/8" to 4" door thickness: throughbolts and thumbturn lever spindle for 4" door will be provided. Throughbolts and spindles may be field cut.
- "VR" and "T" escutcheons are only available for 1-3/8", 1-3/4" and 2-1/4" door thicknesses.

Panel Applications

Specify Quick Code	Description	Add or Deduct
PNL1	Centerline of lockcase to edge of panel not to exceed 2"	Add \$92.00 per lockset

Note:

- When ordering, specify door thickness (less panel), panel thickness, and side of door panel will be applied (outside or inside).

Custom Laser Engraving- LASER

Laser engraving processing charge (all engraving types)

- \$250 net per order. Charge will be applied to production order when placed.

Single Vanity, Logo or Other (same engraving on all parts)

- Lever - \$10 net add each
- Mortise Escutcheon - \$10 net add each
- HPSK Paddle - \$10 net add each

Unique laser engraving (i.e. Room Number, Apartment Number, etc)

- \$12 net add each (per piece)

Miscellaneous Options

Description	Specify Quick Code	Add or Deduct
Split designs and split finishes	Outside Trim x Inside Trim	Higher set price prevails
Spanner head screws	M02	Add \$21.00 per lockset
Torx® head screws (n/a with N escutcheon)	M04	Add \$26.00 per lockset
ANSI wrought strike box	M17	No Charge
Knurling outside and inside	M20 ¹	Add \$148.00 per lockset
Knurling outside only	M21 ¹	Add \$75.00 per lockset
Knurling inside only	M22 ¹	Add \$75.00 per lockset
Abrasive coat outside and inside	M23 ¹	Add \$92.00 per lockset
Abrasive coat inside only	M24 ¹	Add \$47.00 per lockset
Abrasive coat outside only	M25 ¹	Add \$47.00 per lockset
Non-ferrous lockcase	M26	Add \$272.00 per lockset
Lead wrapped case	M29	Add \$287.00 per lockset
Half trim (for ML2010, ML2020, ML2022, ML2024, ML2029, ML2030, ML2032, ML2052, ML2053, ML2055, ML2056, ML2057, ML2058, ML2059, ML2062, ML2065 only) supplied with inside trim only	M30*	Deduct \$40.00 per lockset
Working trim only	M31	See pages 100 thru 116
Latch Hold Back 42, 51, 52, 55, 57 functions	LHB	Add \$44.00 per lockset
HPSK Positive Pull Stop Kit (813F068)		Add \$18.00
HPSK "PUSH" & "PULL" Identification (non-handed)	M38	\$27.00
HPSK Security Lever (not available on non-keyed functions)	M111	No Charge

*Not available with BHSS trim. Requires special application for BLSS, HSS, and HPSK trim.

Electrified Options for ML20900

Description	Specify Quick Code	Add or Deduct
Latchbolt Monitor	M91	\$205.00
Request to Exit (REX)	M92	\$202.00
Security monitor	M105	\$355.00
Latchbolt monitor x request to exit	M91 x M92	\$407.00
Request to Exit x security monitor	M92 x M105	\$557.00

Thumbturn Options

Specify door thickness	Specify Quick Code	Add or Deduct
Ergonomic	M34 ²	Add \$15.00 per TT
Decorative	MT1	No Charge
Decorative square	MT2	No Charge
Decorative cylinder	MT3	No Charge

MT1

MT2

MT3
Notes:

1. Not available on Vineyard™ Collection.
2. M34 is not available with M19N, M19VN or M19SN.

Note: Thumbturn backplate will match shape of rose chosen (i.e. round or square)

Indicator Options

Description	Specify Quick Code	Add or Deduct
Single Indicator Outside - Unlocked/Locked - Green/Red	V10	Add \$125.00 per lockset
Single Indicator Outside - Vacant/Occupied - Green/Red	V20	Add \$125.00 per lockset
Single Indicator Outside - Icons Only - Green/Red	V30	Add \$125.00 per lockset
Single Indicator Outside - Unlocked/Locked - White/Red	V40	Add \$125.00 per lockset
Single Indicator Outside - Vacant/Occupied - White/Red	V50	Add \$125.00 per lockset
Single Indicator Outside - Icons Only - White/Red	V60	Add \$125.00 per lockset
Single Indicator Inside - Unlocked/Locked - Green/Red	V01	Add \$125.00 per lockset
Single Indicator Inside - Icons Only - Green/Red	V03	Add \$125.00 per lockset
Single Indicator Inside - Unlocked/Locked - White/Red	V04	Add \$125.00 per lockset
Single Indicator Inside - Icons Only - White/Red	V06	Add \$125.00 per lockset
Double Indicator - Unlocked/Locked - Green/Red (Outside) Unlocked/Locked - Green/Red (Inside)	V11	Add \$250.00 per lockset
Double Indicator - Vacant/Occupied - Green/Red (Outside) Unlocked/Locked - Green/Red (Inside)	V21	Add \$250.00 per lockset
Double Indicator - Icons Only - Green/Red (Outside) Icons Only - Green/Red (Inside)	V33	Add \$250.00 per lockset
Double Indicator - Unlocked/Locked - White/Red (Outside) Unlocked/Locked - White/Red (Inside)	V44	Add \$250.00 per lockset
Double Indicator - Vacant/Occupied - White/Red (Outside) Unlocked/Locked - White/Red (Inside)	V54	Add \$250.00 per lockset
Double Indicator - Icons Only - White/Red (Outside) Icons Only - White/Red (Inside)	V66	Add \$250.00 per lockset
Single Indicator Outside - Secure/Unsecure - Green/Red (Sectional trim only)	M19S	Add \$127.00 per lockset
Single Indicator Outside - Vacant/Occupied - Green/Red (Sectional trim only)	M19V	AAdd \$127.00 per lockset
Single Indicator Inside - Secure/Unsecure - Green/Red (Sectional trim only)	M19N	Add \$127.00 per lockset
Double Indicator - Secure/Unsecure - Green/Red (Outside) Secure/Unsecure - Green/Red (Inside), (Sectional trim only)	M19SN	Add \$254.00 per lockset
Double Indicator - Vacant/Occupied - Green/Red (Outside) Secure/Unsecure - Green/Red (Inside) (Sectional trim only)	M19VN	Add \$254.00 per lockset
Hotel Indicator - Only Available for ML2029	M19	No Charge
Outside Engraving with "Lock" and Directional Arrow	EMA	Add \$44.00 per lockset
Inside Engraving with "Lock" and Directional Arrow	EMB	Add \$44.00 per lockset
Engraving Both Sides with "Lock" and Directional Arrow	EMC	Add \$88.00 per lockset

Sectional Trim Retrofit Kits for V Series Indicators (for M19 indicator refer to parts pages)

Description	Model #	List Price
Keyed Functions	ML190	\$215.00
Cointurn for Emergency Override	ML193	\$215.00
Thumbturn	ML194	\$215.00
No Input - Blank	ML197	\$215.00

NOTES:

When ordering sectional trim retrofit kits, specify finish, hand and V code required. i.e. ML190 x RH x 626 x V01.

Kits accommodate indicators on one side of the door only. If indicators are required for both sides, 2 kits must be ordered as required by function.

For escutcheon retrofit kits, specify function, trim, hand, finish and V code required X M31 option. See pages 100-133 for pricing, add for indicator also applies.

Indicators and directional arrow engraving are available with the following functions:

ML2002, ML2003, ML2011, ML2012, ML2013, ML2017, ML2020, ML2022, ML2024, ML2029, ML2030, ML2048, ML2049, ML2059, ML2060, ML2062, ML2065, ML2067, ML2068, ML2069, ML2072, ML2073, ML2075, ML2082, ML2092, ML20608 x NAC x SEC x PHR, ML20609 x NAC x SEC x PHR.

Please refer to the ML2000 Series catalog for more information.

Ordering Examples:

Function	Lever	Rose	Hand	Finish	Options
ML2002	NS	A	RH	626	V01

Double cylinder classroom intruder function x sectional trim x single indicator inside – Unlocked/Locked – Green/Red.

Function	Lever	Escutcheon	Hand	Finish	Options
ML2060	NS	VN	RH	626	V21 x EMB

Privacy function x escutcheon trim x double indicator – Vacant/Occupied – Green/Red (Outside) Unlocked/Locked – Green/Red (Inside) x inside engraving with "lock" and directional arrow.

NOTES:

- M19 series indicators are not available with BHSS or BLSS trims.
- V series indicators are not available with BHSS, BLSS, HSS or HPSK trims.
- EMA, EMB and EMC are only for use with V series indicators, for all other engraving, please refer to custom engraving options.
- Contact customer service for other available or custom indicator wording and/or colors.

MicroShield® Specialty Hardware Finishes, How to Order, Pricing	142
Behavioral Health Series™ Lever Design: BHSS	143
Behavioral Health Series™ Lever Design: BLSS	144
Anti-Harm Knob Trim Knob Design: HSS	145
Specialty Hardware HPSK Trim	146
 HP3000 Series Tubular Lock with Push/Pull Trim:	
HP3000 Series Features & Ordering Example	147
HP3000 Series Strike, Door Thickness, Backset, Miscellaneous Options	148



Look for the  *MicroShield* icon.

MicroShield®

As part of their promise to provide innovative solutions to their customers, certain ASSA ABLOY Group brands offer the MicroShield® technology, a silver-based antimicrobial coating designed to inhibit the growth of bacteria.

MicroShield® is a registered trademark of Yale Security Inc., an ASSA ABLOY Group company.

Product	Trim	MicroShield® Coated Components
Specialty Hardware	BHSS, BLSS, HSS, HPSK	Knobs/Levers, roses and/or escutcheons

AVAILABLE FINISHES

- MicroShield® is available on 626 and 630. Other finishes available by Special Product Application Request Form only.
- Specify 626C (satin chrome plated) or 630C (satin stainless steel) when ordering.
- MicroShield® coating will be applied over 626 and 630 finishes. All components will match 626.

Note: MicroShield® coating will only be applied to "high touch" components.

HOW TO ORDER

Product	How to Order
Mortise Locks	ML2055 x BHSS x 630C x RHR

Description	Add
Cylindrical Locks & Mortise Locks	Add \$69.00

Behavioral Health Series™

Lever Design: BHSS

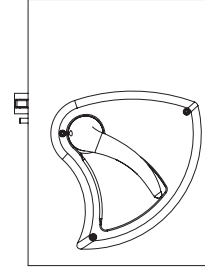

BHSS

Lever: Cast
Escutcheon: Cast

			630
Non-Keyed	ML2010	Passage	\$1,782.00
	ML2020	Privacy	\$1,901.00
	ML2030	Privacy	
	ML2060	Privacy	\$1,839.00
Single Cylinder	ML2003	Classroom	\$1,917.00
	ML2051	Office	
	ML2055	Classroom	
	ML2056	Classroom HB	
	ML2057	Storeroom	
	ML2069	Institution Privacy	\$1,934.00
	ML2053	Entrance	
	ML2054	Entrance	
	ML2058	Entrance Holdback	
Single Cylinder with Deadbolt	ML2024	Entrance	\$1,953.00
	ML2048	Entrance	
	ML2065	Dormitory	
	ML2059	Security Storeroom	
	ML2067	Apartment	
	ML2073	Classroom Security	
	ML2075	Entrance/Office	
	ML2029	Hotel	\$2,008.00
Double Cylinder	ML2002	Classroom Intruder	\$2,010.00
	ML2032	Institution	
	ML2042	Entrance	
	ML2052	Classroom Intruder	
	ML2087	Security Vestibule	
Double Cylinder with Deadbolt	ML2022	Store Door	\$2,046.00
	ML2062	Intruder Deadbolt	
	ML2072	Classroom Security Intruder	
	ML2082	Dormitory	
	ML2092	Security Institution	
Single Cylinder	ML20906	Fail Safe/Fail Secure	\$2,135.00
	ML20914		
No Cylinder Override	ML20907	Fail Safe/Fail Secure	\$1,897.00
	ML20915		
Double Cylinder	ML20932	Fail Safe/Fail Secure	\$2,228.00
	ML20987		
Full Working Trim	M31	No cylinder; includes thumbturn lever	\$1,379.00

Behavioral Health Series™

Lever Design: BLSS

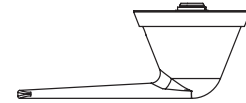
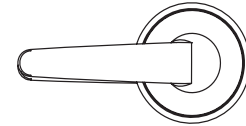

BLSS

Lever: Cast
Rose: Wrought

630

			630
Non-Keyed	ML2010	Passage	\$1,720.00
	ML2030	Privacy	\$1,839.00
	ML2060	Privacy	\$1,777.00
Single Cylinder	ML2055	Classroom	\$1,855.00
	ML2057	Storeroom	
	ML2069	Institution Privacy	
Single Cylinder with Deadbolt	ML2054	Entrance	\$1,872.00
	ML2024	Entrance	\$1,891.00
	ML2065	Dormitory	
Double Cylinder	ML2067	Apartment	\$1,948.00
	ML2032	Institution	
	ML2042	Entrance	
Double Cylinder with Deadbolt	ML2052	Classroom Intruder	\$1,984.00
	ML2087	Security Vestibule	
Single Cylinder	ML2022	Store Door	\$1,984.00
	ML2062	Intruder Deadbolt	
No Cylinder Override	ML20906	Fail Safe/Fail Secure	\$2,073.00
	ML20914		
Double Cylinder	ML20907	Fail Safe/Fail Secure	\$1,980.00
	ML20915		
Full Working Trim	ML20932	Fail Safe/Fail Secure	\$2,166.00
	ML20987		
Full Working Trim	M31	No cylinder; includes thumbturn lever	\$1,317.00

Anti-Harm Knob Trim

Knob Design: HSS



HSS

HSS¹
630²

Function			
Non-Keyed	ML2010	Passage	Knob: Brass
	ML2020	Privacy	
	ML2060	Privacy	
	ML2090	Full Active Dummy Trim	
Single Cylinder	ML2003	Classroom	\$1,987.00
	ML2051	Office	
	ML2055	Classroom	
	ML2056	Classroom Holdback	
	ML2057	Storeroom	\$2,002.00
	ML2069	Institution Privacy	
	ML2053	Entrance	
	ML2054	Entrance	
Single Cylinder with Deadbolt	ML2058	Entrance Holdback	\$2,023.00
	ML2068	Privacy or Apartment	
Double Cylinder	ML2024	Entrance	\$2,023.00
	ML2002	Classroom Intruder	\$2,080.00
	ML2032	Institution	
	ML2042	Entrance	
	ML2052	Classroom Intruder	
ML2087	Security Vestibule		
Double Cylinder with Deadbolt	ML2022	Store Door	\$2,116.00
	ML2092	Security Institution	
Deadlock	ML2011	Single Cylinder	\$618.00
	ML2012	Double Cylinder	\$711.00
	ML2013	Cylinder x Thumbturn	\$648.00
	ML2017	Classroom Function Cylinder x Thumbturn	
Single Cylinder	ML20906	Fail Safe/Fail Secure	\$2,205.00
	ML20914		
No Cylinder Override	ML20907	Fail Safe/Fail Secure	\$2,112.00
	ML20915		
Double Cylinder	ML20932	Fail Safe/Fail Secure	\$2,298.00
	ML20987		

Notes:
 1. Sectional lever trim x HSS available.
 2. 619 finish provided to match 630 finish.

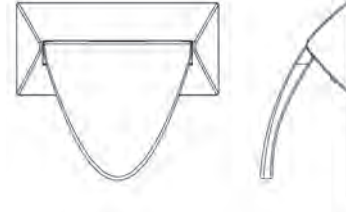

HPSK
Lever: Cast
Rose: Wrought

Function			630
Non-Keyed	ML2010	Passage	\$1,106.00
	ML2020	Privacy	\$1,138.00
	ML2030	Privacy	
	ML2060	Privacy	\$1,134.00
	ML2090	Full Active Dummy Trim	\$1,135.00
Single Cylinder	ML2003	Classroom	\$1,217.00
	ML2051	Office	
	ML2055	Classroom	
	ML2056	Classroom	
	ML2057	Storeroom	
	ML2069	Institution Privacy	\$1,230.00
	ML2053	Entrance	
	ML2054	Entrance	
	ML2058	Entrance Holdback	
ML2068	Privacy or Apartment		
Single Cylinder with Deadbolt	ML2024	Entrance	\$1,253.00
	ML2048	Entrance	
	ML2065	Dormitory	
	ML2059	Security Storeroom	
	ML2067	Apartment	
	ML2073	Classroom Security	
	ML2075	Entrance/Office	
	ML2029	Hotel	\$1,308.00
Double Cylinder	ML2002	Classroom Intruder	\$1,310.00
	ML2032	Institution	
	ML2042	Entrance	
	ML2052	Classroom Intruder	
	ML2087	Security Vestibule	
Double Cylinder with Deadbolt	ML2022	Store Door	\$1,403.00
	ML2062	Intruder Deadbolt	
	ML2072	Classroom Security Intruder	
	ML2082	Dormitory	
	ML2092	Security Institution	
Single Cylinder	ML20906	Fail Safe/Fail Secure	\$1,435.00
	ML20914		
No Cylinder Override	ML20907	Fail Safe/Fail Secure	\$1,342.00
	ML20915		
Double Cylinder	ML20932	Fail Safe/Fail Secure	\$1,528.00
	ML20987		
Full Working Trim	M31	No cylinder, includes thumbturn lever	\$642.00

Standard Features

Handing

Passage (HP3010) function is non-handed
Privacy (HP3020) function is handed

Door Thickness

1-3/4" (44mm) standard.
Optional door thicknesses available

Backset (5" - Standard)

5" (127mm) standard.
Optional: 2-3/4" (70mm) and 7" (177mm)

Strike

ANSI curved lip strike standard, 4-7/8" x 1-1/4" x 1-1/4" lip to center.

Optional strikes, lip lengths and ANSI wrought strike box available

Latchbolt

Brass, 1/2" (13mm) throw

Covers

Cast stainless steel

Paddles

Cast stainless steel



Ordering Example

Stock Order

Series/Function	Trim	Finish	Hand*
HP3010	HPSK	630	RH

*Passage (HP3010) function is non-handed and privacy (HP3020) function is handed.

Function	Description	Finish
		630
HP3010	Passage	\$470.00
HP3020	Privacy	\$610.00

Strike Options

Lip to Center	ANSI Curved Lip. Specify	Curved Lip Box. Specify	Full Lip. Specify	Add or Deduct
1" (25mm)	SA100	SC100		No Charge
1-1/8" (29mm)	SA118	SC118		
1-1/4" (32mm)	(standard)	SC114	SF114*	
1-3/8" (35mm)	SA138	SC138		
1-1/2" (38mm)	SA112	SC112		
1-3/4" (44mm)	SA134	SC134		Add \$17.00 per lockset
2" (51mm)	SA200	SC200		
2-1/4" (57mm)	SA214	SC214		
2-1/2" (28mm)	SA212	SC212		
2-3/4" (70mm)	SA234	SC234		
3" (76mm)	SA300	SC300		

* Specify SFR114 for rounded corner.

Door Thickness Options

Description	Specify Quick Code	Add or Deduct
1-3/4" (44mm)	(standard)	No Charge
2" (51mm)	D200	
2-1/4" (57mm)	D214	

Backset Options

Description	Specify Quick Code	Add or Deduct
2-3/4" (70mm)	B234	No Charge
5" (127mm)	(standard)	
7" (177mm)	B700	Add \$6.00 per lockset

Miscellaneous Options

Description	Specify Quick Code	Add or Deduct
Spanner head screws	M02	Add \$21.00 per lockset
Torx® head screws	M04	Add \$26.00 per lockset
Latch front, rounded corners	M13	Add \$2.50 per latch
ANSI wrought strike box	M17	No Charge
Lead lining. Specify Push or Pull side.	M28	Add \$296.00 per lockset
"PUSH & PULL" Identification*	M38	Add \$27.00
Retrofit Kit (part no. 791F39)		Add \$59.00
HP3000 Positive Pull Stop Kit (813F068)		Add \$18.00

Grade 1 Vandal Resistant Cylindrical Lever Locksets CL3100 Series:

MicroShield® Cylindrical Locksets Finishes, How to Order, Pricing	150
-------------------------------------------------------------------	-----

TL3700 Museo Series Tubular Locksets:

TL3700 Series: Museo Georgia, Pablo, Jackson, Salvador, Marc Levers & Inspire Trim:	151
TL3700 Series: Museo Georgia, Pablo, Jackson, Salvador, Marc Levers & Roses	152
TL3700 Series: Museo Josef, Georges Levers & Roses	153
TL3700 Series: Museo Piet Levers & Roses	154
TL3700 Series: Options	155

Grade 1 Vandal Resistant Cylindrical Lever Locksets CL3100 Series:

CL3100 Series Standard Features, Ordering Examples	156
CL3100 Series Lever Designs	157
CL3100 Series Cylinder Options	158
CL3100 Series Keying Options	159
CL3100 Series Door Thickness, Backset, Strike Options	160
CL3100 Series Miscellaneous Options	161

Grade 1 Extra Heavy-Duty Cylindrical Lever Locksets CL3300 Series:

CL3300 Series Standard Features & Ordering Examples	162
CL3300 Series Lever Designs	163
CL3300 Series Cylinder Options	164
CL3300 Series Keying Options	165
CL3300 Series Door Thickness, Backset, Strike Options	166
CL3300 Series Miscellaneous Options	167

Grade 1 Heavy-Duty Cylindrical Lever Locksets CL3500 Series:

CL3500 Series Standard Features & Ordering Examples	168
CL3500 Series Lever Designs	169
CL3500 Series Cylinder Options	170
CL3500 Series Keying Options	171
CL3500 Series Door Thickness, Backset, Strike Options	172
CL3500 Series Miscellaneous Options	173

Grade 2 Standard-Duty Lever Locksets CL3800 Series:

CL3800 Series Standard Features & Ordering Options	174
CL3800 Series Lever Designs	175
CL3800 Series Cylinder & Keying Options	176
CL3800 Series Door Thickness, Backset, Strike, Miscellaneous Options	177

Grade 1 Heavy-Duty Cylindrical Knob Locksets CK4300 Series:

CK4300 Series Standard Features & Ordering Example	178
CK4300 Series Knob Designs, Cylinder Keying Options	179
CK4300 Series Strike, Backset, Door Thickness, Miscellaneous Options	180

Grade 2 Standard-Duty Cylindrical Knob Locksets CK4400 Series:

CK4400 Series Standard Features & Ordering Example	181
CK4400 Series Knob Designs, Cylinder & Keying Options, Backset Options	182
CK4400 Series Strike, Miscellaneous Options	183
Blank Page	184



TL3700
CL3100
CL3300
CL3500
CL3800

MicroShield®

As part of their promise to provide innovative solutions to their customers, certain ASSA ABLOY Group brands offer the MicroShield® technology, a silver-based antimicrobial coating designed to inhibit the growth of bacteria.

MicroShield® is a registered trademark of Yale Security Inc., an ASSA ABLOY Group company.

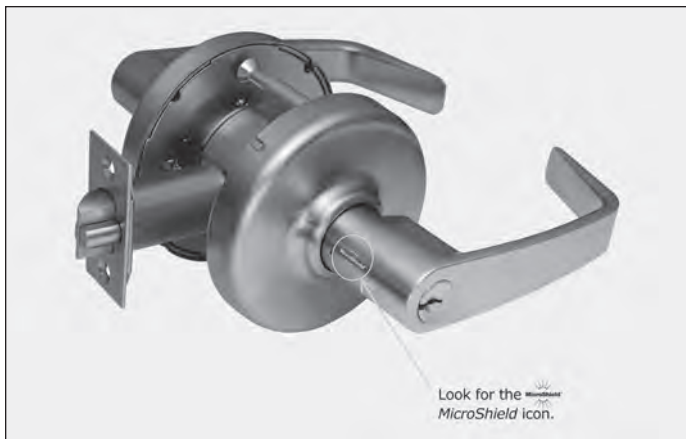

Product	Series	MicroShield® Coated Components
Cylindrical Locks	CL3100, CL3300, CL3500, and CL3800 Series	Levers*, roses

AVAILABLE FINISHES

- MicroShield® is available on 626. Other finishes available by Special Product Application Request Form only.
- Specify 626C (satin chrome plated) when ordering.
- MicroShield® coating will be applied over 626 finish. All components will match 626.

* MicroShield® coating will only be applied to "high touch" components.

HOW TO ORDER

Product	How to Order
Cylindrical Locks	CL3355 x NZD x 626C

Description	Add
Cylindrical Locks	Add \$69.00

Tubular Locksets

TL3700 Series: Muséo Levers and Inspire™ Roseless Trim

USA & Canada Prices Effective March 16, 2020



contemporary trim to complement the interior design of your next project

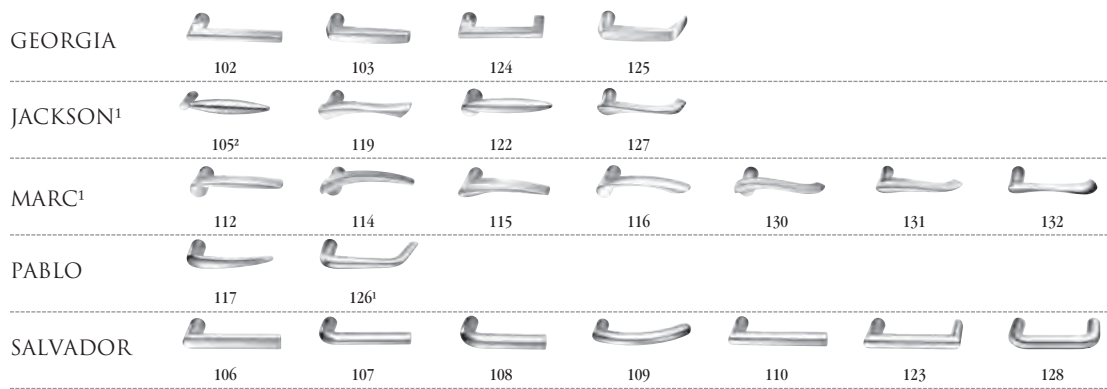

¹Handed: specify hand when ordering
²Contact factory for current lead time

613E	Dark Oxidized Satin Bronze - Equivalent	605	Bright Brass, Clear Coated
626	Satin Chromium Plated	606	Satin Brass, Clear Coated
BSP	Black Suede Powder Coat	611	Bright Bronze, Clear Coated
WSP	White Suede Powder Coat	612	Satin Bronze, Clear Coated
		613	Dark Oxidized Satin Bronze, Oil Rubbed
		613L	Dark Oxidized Satin Bronze, Clear Coated
		618	Bright Nickel Plated
		619	Satin Nickel Plated
		625	Bright Chromium Plated
		629*	Bright Stainless Steel
		630*	Satin Stainless Steel
		722	Black Oxidized Bronze, Oil Rubbed

Function

TL3710	Passage Set	\$253.00	\$263.00
TL3710A	Passage Set-3 Hour	\$259.00	\$269.00
TL3720	Privacy Set	\$265.00	\$275.00
TL3720A	Privacy Set-3 Hour	\$271.00	\$281.00
TL3750	Single Lever Pull-Through Bolted	\$112.00	\$117.00
TL3770	Double Lever Pull	\$209.00	\$219.00
TL3780	Communicating Set	\$253.00	\$263.00
TL3780A	Communicating Set-3 Hour	\$259.00	\$269.00

Ordering Example Details →

TL3710 Passage: Non-Keyed tubular lock
 102J Georgia Family Lever, J Collar
 626 Satin Chrome Finish
 LH Left Handed

Trim Only				
Quantity	Series/Function	Trim	Finish	Hand
24	TL3710	102J	626	LH

*629 and *630 finish options are Not available for all Muséo levers. Please refer to page 20 for availability.



Experience a safer
and more open world

Tubular Locksets

TL3700 Series: Muséo Levers and Roses

USA & Canada Prices Effective March 16, 2020

contemporary trim to complement the interior design of your next project

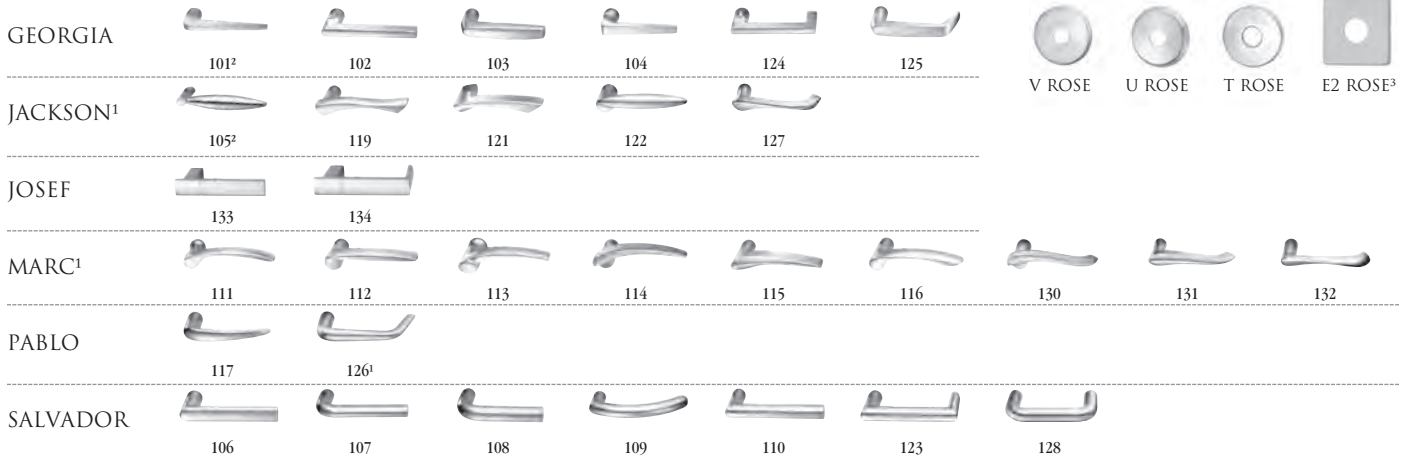

¹Handed: specify hand when ordering

²Contact factory for current lead time

³CAUTION: Cannot retrofit on existing cylindrical lock door preps with through-bolt holes outside the 2-1/8" bored hole (Ex. CL3300 & CL3500).

613E	Dark Oxidized Satin Bronze - Equivalent
626	Satin Chromium Plated
BSP	Black Suede Powder Coat
WSP	White Suede Powder Coat

605	Bright Brass, Clear Coated
606	Satin Brass, Clear Coated
611	Bright Bronze, Clear Coated
612	Satin Bronze, Clear Coated
613	Dark Oxidized Satin Bronze, Oil Rubbed
613L	Dark Oxidized Satin Bronze, Clear Coated
618	Bright Nickel Plated
619	Satin Nickel Plated
625	Bright Chromium Plated
629*	Bright Stainless Steel
630*	Satin Stainless Steel
722	Black Oxidized Bronze, Oil Rubbed

Function

Model	Function	Price	Price
TL3710	Passage Set	\$236.00	\$246.00
TL3710A	Passage Set-3 Hour	\$242.00	\$252.00
TL3720	Privacy Set	\$252.00	\$262.00
TL3720A	Privacy Set-3 Hour	\$258.00	\$268.00
TL3750	Single Lever Pull-Through Bolted	\$134.00	\$139.00
TL3750S	Single Lever Pull-Surface Mounted	\$104.00	\$114.00
TL3770	Double Lever Pull	\$197.00	\$207.00
TL3780	Communicating Set	\$236.00	\$246.00
TL3780A	Communicating Set-3 Hour	\$242.00	\$252.00

Ordering Example Details →

TL3710 Passage: Non-Keyed tubular lock
 111T Marc Lever, T-Rose
 626 Satin Chrome Finish
 LH Left Handed

Trim Only				
Quantity	Series/Function	Trim	Finish	Hand
24	TL3710	111T	626	LH

*629 and *630 finish options are Not available for all Muséo levers. Please refer to page 20 for availability.



Experience a safer and more open world

Tubular Locksets

TL3700 Series: Muséo Levers and Roses

USA & Canada Prices Effective March 16, 2020

contemporary levers to complement the interior design of your next project



JOSEF



135 136 137 138

GEORGES



139 140* 141* 142 143*

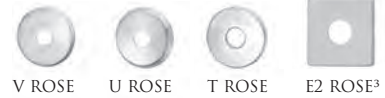

*Georges Levers 140, 141 and 143 are not available for the following functions: TL3720 and TL3720A

¹Handed: specify hand when ordering

²Contact factory for current lead time

³**CAUTION:** Cannot retrofit on existing cylindrical lock door preps with through-bolt holes outside the 2-1/8" bored hole (Ex. CL3300 & CL3500).

613E Dark Oxidized Satin Bronze - Equivalent
626 Satin Chromium Plated
BSP Black Suede Powder Coat
WSP White Suede Powder Coat

605 Bright Brass, Clear Coated
606 Satin Brass, Clear Coated
611 Bright Bronze, Clear Coated
612 Satin Bronze, Clear Coated
613 Dark Oxidized Satin Bronze, Oil Rubbed
613L Dark Oxidized Satin Bronze, Clear Coated
618 Bright Nickel Plated
619 Satin Nickel Plated
625 Bright Chromium Plated
629 Bright Stainless Steel
630 Satin Stainless Steel
722 Black Oxidized Bronze, Oil Rubbed

Function

Function	Price	Price
TL3710 Passage Set	\$327.00	\$337.00
TL3710A Passage Set-3 Hour	\$333.00	\$343.00
TL3720* Privacy Set	\$340.00	\$350.00
TL3720A* Privacy Set-3 Hour	\$346.00	\$356.00
TL3750 Single Lever Pull-Through Bolted	\$218.00	\$228.00
TL3750S Single Lever Pull-Surface Mounted	\$188.00	\$198.00
TL3770 Double Lever Pull	\$288.00	\$298.00
TL3780 Communicating Set	\$327.00	\$337.00
TL3780A Communicating Set-3 Hour	\$333.00	\$343.00

Ordering Example Details →

TL3710 Passage: Non-Keyed tubular lock
135E2 Josef Lever, E2 Rose
626 Satin Chrome Finish
LH Left Handed

Trim Only				
Quantity	Series/Function	Trim	Finish	Hand
24	TL3710	135E2	626	LH



Experience a safer and more open world

Tubular Locksets

TL3700 Series: Muséo Levers and Roses

USA & Canada Prices Effective March 16, 2020

contemporary trim to complement the interior design of your next project



PIET

25M 27M 21M* 21S

*613E, BSP, WSP finishes are not available with 21M levers.



V ROSE U ROSE T ROSE E2 ROSE1

613E Dark Oxidized Satin Bronze – Equivalent
 629 Bright Stainless Steel
 630 Satin Stainless Steel
 BSP Black Suede Powder Coat
 WSP White Suede Powder Coat

Function

TL3710	Passage Set	257.00
TL3710A	Passage Set - 3 Hour	263.00
TL3720	Privacy Set	272.00
TL3720A	Privacy Set - 3 Hour	278.00
TL3750	Single Lever Pull - Through Bolted	148.00
TL3750S	Single Lever Pull - Surface Mounted	118.00
TL3770	Double Lever Pull	218.00
TL3780	Communicating Set	257.00
TL3780A	Communicating Set - 3 Hour	263.00



PIET

23M

613E Dark Oxidized Satin Bronze – Equivalent
 629 Bright Stainless Steel
 630 Satin Stainless Steel
 BSP Black Suede Powder Coat
 WSP White Suede Powder Coat

Function

TL3710	Passage Set	318.00
TL3710A	Passage Set - 3 Hour	324.00
TL3720	Privacy Set	330.00
TL3720A	Privacy Set - 3 Hour	336.00
TL3750	Single Lever Pull - Through Bolted	203.00
TL3750S	Single Lever Pull - Surface Mounted	173.00
TL3770	Double Lever Pull	271.00
TL3780	Communicating Set	318.00
TL3780A	Communicating Set - 3 Hour	324.00



PIET

21G 21L

613E Dark Oxidized Satin Bronze – Equivalent
 629 Bright Stainless Steel
 630 Satin Stainless Steel
 BSP Black Suede Powder Coat
 WSP White Suede Powder Coat

Function

TL3710	Passage Set	337.00
TL3710A	Passage Set - 3 Hour	343.00
TL3720	Privacy Set	350.00
TL3720A	Privacy Set - 3 Hour	356.00
TL3750	Single Lever Pull - Through Bolted	228.00
TL3750S	Single Lever Pull - Surface Mounted	198.00
TL3770	Double Lever Pull	298.00
TL3780	Communicating Set	337.00
TL3780A	Communicating Set - 3 Hour	343.00

Ordering Example Details

TL3710 Passage: Non-Keyed tubular lock
 23MU Piet Family Lever - Wood Insert, U-Rose
 29BH29 Lever Finish
 Wood insert with polished stainless steel (629) shank and polished stainless steel (629) grip
 629 Lock Finish
 LH Left Handed

Stock Order

Quantity	Series/Function	Trim	Lever Finish	Lock Finish	Hand
2	TL3710	21WU	29BH29	629	LH

CAUTION: Cannot retrofit on existing cylindrical lock door preps with through-bolt holes outside the 2-1/8" bored hole (Ex. CL3300 & CL3500).



Experience a safer and more open world

Door Thickness Options

Description	Specify Quick Code	Add or Deduct
1-3/8" (35mm) up to 1-3/4" (44mm)	D138	No Charge
1-3/4" (44mm) up to 2-1/4" (57mm)	(standard)	
2-1/4" (57mm) up to 2-1/2" (64mm)	D214	
(Consult factory if over 2-1/2" (64mm))		

Backset Options

Description	Specify Quick Code	Add or Deduct
2-3/4"	(standard)	No Charge
2-3/8" ¹	B238	

Strike Options

Lip Length	ANSI Curved Lip - Specify Quick Code	Curved Lip Box - Specify Quick Code	Full Lip Specify Quick Code	Full Lip Radius Corner Specify Quick Code	Add or Deduct
1"	SA100	SC100			No Charge
1-1/8"	SA118	SC118			
1-1/4"	SA114	(standard)	SF114	SFR114	
1-3/8"	SA138	SC138			
1-1/2"	SA112	SC112 ²			Add \$17.00 per lockset
1-3/4"	SA134	SC134			
2"	SA200	SC200			
2-1/4"	SA214	SC214			
2-1/2"	SA212	SC212			
2-3/4"	SA234	SC234			
3"	SA300	SC300			

Miscellaneous Options

Description	Specify Quick Code	Add or Deduct
Latch front, rounded corners	M13	Add \$2.50 per latch
1" (25mm) latch front, square corners ³	M14	Add \$6.00 per lockset
1" (25mm) latch front, rounded corners	M15	Add \$2.50 per latch
ANSI wrought strike box	M17	Add \$6.00 per lockset

Notes:

1. 1" front supplied standard
2. Standard for D214
3. Standard for 2-3/8" backset



Standard Features

Handing

Non-handed

Door Thickness

1-3/4" - 2 standard

Backset

2-3/4" standard

Strike

ANSI curved lip
4-7/8" x 1-1/4" x 1-1/4" lip to center

Cylinder

Brass, 6-pin, L4 keyway, 0-bitted

Keys

Two nickel silver keys

Case Quantity

6

Case Weight

32 lbs

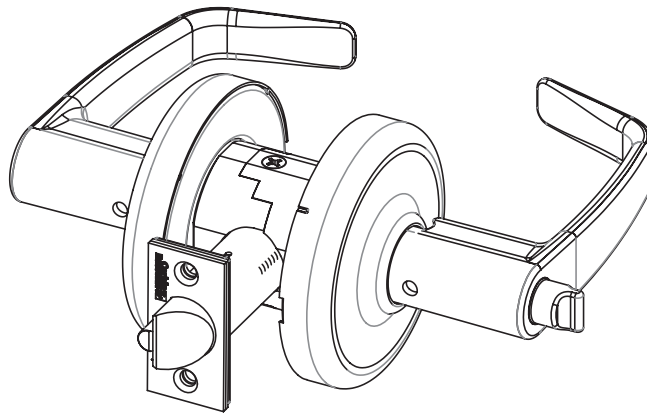

Ordering Examples

Stock Order

Quantity	Series/Function	Trim	Finish	Hand
100	CL3155	NZD	626	RHR

Split Finish Order

Quantity	Series/Function	Finish		Hand
		Outside	Inside	
12	CL3155	626	625	RHR

Note: Higher set price prevails

Contract/Detailed Order

Quantity	Keypad	Series/Function	Trim	Finish	Hand	Strike	Misc. Options	Cylinder and Keying
24	AA1	CL3155	NZD	626	RHR	SA112	M17	C6-VKC3

Lever Designs:



Levers

Roses

Lever:
Die cast zinc

Rose:
Brass

Newport



C ROSE

Armstrong

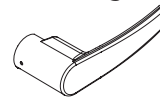

D ROSE

Princeton

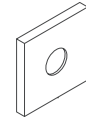

E ROSE



K ROSE

Function	Description		AZC, AZD, AZE, AZK, NZC, NZD, NZE, NZK, PZC, PZD, PZE, PZK	
			Finish: 613E, 626, BSP, WSP	Finish: 605, 606, 611, 612, 613, 613L, 618, 619, 625, 722
CL3110	Non-Keyed	Passage	\$525.00	\$541.00
CL3120		Privacy	\$598.00	\$614.00
CL3120H		Hospital Privacy		
CL3140NT		Exit Latch		
CL3150		Half Dummy	\$236.00	\$244.00
CL3170		Full Dummy	\$469.00	\$485.00
CL3180		Passage x blank plate	\$598.00	\$614.00
CL3151	Single Cylinder	Entrance	\$706.00	\$722.00
CL3155		Classroom		
CL3157		Storeroom	\$721.00	\$737.00
CL3161		Entrance		
CL3175		Corridor/dormitory		
CL3193		Service Station	\$792.00	\$808.00
CL3129		Hotel	\$828.00	\$844.00
CL3132	Institution			
CL3152	Classroom Intruder			
CL3162	Communicating			
CL3172	Public Toilet			

Cylinder Options

Description	Specify Quick Code	Add or Deduct
Conventional 6-pin	(standard)	No Charge
Conventional 7-pin	7P	Add \$2.00 per cylinder
Less Cylinder ⁴	LC	Deduct \$93.00 per cylinder
Access 3 Patented	AP	No Charge
Access 3 Security	AS	Add \$61.00 per cylinder
Access 3 High Security, UL 437	AHS	Add \$86.00 per cylinder
Access 3 IC Patented	ACP	Add \$80.00 per cylinder
Access 3 IC Security	ACS	Add \$132.00 per cylinder
Access 3 IC High Security, UL 437	ACHS	Add \$153.00 per cylinder
Pyramid Security Fixed Core ³	PS	Add \$64.00 per cylinder
Pyramid Security IC ³	PCS	Add \$140.00 per cylinder
Pyramid High Security Fixed Core ³	PHS	Add \$94.00 per cylinder
Pyramid High Security IC ³	PCHS	Add \$171.00 per cylinder
Pyramid IC with Temporary Construction Core	CTP	Add \$80.00 per cylinder
Pyramid IC with Temporary Disposable Core	CTPD	No Charge
Pyramid IC Less Core	CLP	No Charge
Security ³	HS	Add \$119.00 per cylinder
Security IC ³	CHS	Add \$199.00 per cylinder
IC 6-pin	C6	Add \$80.00 per cylinder
IC 6-pin with Temporary Construction Core (Red)	CT6R	Add \$80.00 per cylinder
IC 6-pin with Temporary Construction Core (Blue)	CT6B	Add \$80.00 per cylinder
IC 6-pin with Temporary Construction Core (Green)	CT6G	Add \$80.00 per cylinder
IC 6-pin with Temporary Disposable Core	CT6D	No Charge
Small Format Temporary Disposable Core	CTSD	No Charge
IC 6-pin Less Core ³	CL6	No Charge
IC 7-pin	C7	Add \$82.00 per cylinder
IC 7-pin with Temporary Construction Core (Red)	CT7R	Add \$82.00 per cylinder
IC 7-pin with Temporary Construction Core (Blue)	CT7B	Add \$82.00 per cylinder
IC 7-pin with Temporary Construction Core (Green)	CT7G	Add \$82.00 per cylinder
IC 7-pin with Temporary Disposable Core	CT7D	No Charge
IC 7-pin Less Core ³	CL7	
Lockset furnished in Schlage® C Keyway ^{1,3}	C	
Lockset furnished in Sargent® LA Keyway ^{2,3}	LA	

Notes:

1. Available 0-bitted & key random (KR) only.
2. Available 0-bitted only.
3. Not available in CL3129 function.
4. CL3129 function is not available less cylinder.

Keying Options*

Description	Specify Quick Code	Add or Deduct
0-Bitted with 2 blank keys	(standard)	No Charge
Keyed random	KR	
Master keyed (all cylinders except 8000, 8020, 8027 IC core)	Specify keyset	Add \$16.00 per cylinder
Master keyed Pyramid	Specify keyset	
Master keyed Security (including IC cylinder and core)	Specify keyset	
Master keyed (8000, 8020, 8027 IC core)	Specify keyset	No Charge
Master keyed to customer bittings or sample key	Specify keyset	Add \$16.00 per cylinder
Construction master keyed ^{1,2}	CMK	Add \$16.00 per cylinder
Visual key control (VKC)		
-No stamping	VKC0	\$4.50
-Keys only	VKC1	No Charge
-Cylinder and Keys ³	VKC2	\$8.00
-Cylinders only ³	VKC3	\$8.00
Concealed key control (CKC)		
-CKC cylinders with VKC keys	CKC2	\$8.00
-CKC cylinders only ³	CKC3	\$8.00
More than 2 keys per lock	KY# (e.g., KY6)	See page 31 - Cut Keys Section

Notes:

1. CMK Construction master keying charge is in addition to master keying charge.
2. CMK Construction master keying is not available in interchangeable core, Access 3, Pyramid, or Security series..
3. VKC2, VKC3, CKC3 are not available in Access 3, Pyramid or Security series.

*Double cylinder keying: unless otherwise specified, both cylinders of 32, 52 and 62 functions will be keyed alike. The inside cylinder of 72 function will be keyed to the master key(s) only, while the outside cylinder will include the change key.

If different keying is required, specify outside cylinder first, then inside cylinder.

For key bows other than 10 and 90, specify 'KB' + bow number as Quick Code, e.g. KB12.

Door Thickness Options

Description	Specify Quick Code	Add or Deduct
1-3/4" - 2"	(standard)	No Charge
Over 2" up to 2-1/4"	D214	

Backset Options

Description	Specify Quick Code	Add or Deduct
2-3/4"	(standard)	No Charge
3-3/4"	B334	Add \$15.00 to lockset
5"	B500	Add \$24.00 to lockset

Strike Options² (to purchase strike separately, see catalog or parts manual for part no.)

Lip Length	ANSI Curved Lip - Specify Quick Code	Curved Lip Box - Specify Quick Code	Add or Deduct
1"	SA100	SC100	No Charge
1-1/8"	SA118	SC118	
1-1/4"	(standard)	SC114	
1-3/8"	SA138	SC138	
1-1/2"	SA112	SC112	Add \$17.00 per lockset
1-3/4"	SA134	SC134	
2"	SA200	SC200	
2-1/4"	SA214	SC214	
2-1/2"	SA212	SC212	
2-3/4"	SA234	SC234	
3"	SA300	SC300	

^{1,2}If door thickness is standard or has been specified and no special door or frame condition exist, then only the first two characters of the optional strike Quick Code must be specified (e.g. "SC").
The correct lip length will be determined by our order entry system based on the standard or specified door thickness.

Miscellaneous Options		
Description	Specify Quick Code	Add or Deduct
Spanner head screws	M02	Add \$21.00 per lockset
Torx® head screws	M04	Add \$26.00 per lockset
Less cylinder and with tailpiece for Schlage® fixed core cylinder (AZ, NZ & PZ designs) ²	M06	No Charge
Lever to accept 6 or 7-pin SFIC (AZ, NZ & PZ designs) ²	M08	No Charge
Lever to accept Sargent® fixed core cylinder (AZ, NZ & PZ designs) ²	M09	No Charge
Security Lever (not available on non-keyed functions)	M111	No Charge
3/4" throw fire latch x 2-3/4" backset (not available for CL3120, 29, 40, and 93 functions)	M16	Add \$100.00 per lockset
Finishes Matching		
Available Lock Finish		
605 605		
606 606, 611, 612, 613		
626 625, 626		
ANSI wrought strike box	M17	No Charge
Knurling outside and inside	M20	Add \$148.00 per lockset
Knurling outside only	M21	Add \$75.00 per lockset
Knurling inside only	M22	Add \$75.00 per lockset
Abrasive coat outside and inside	M23	Add \$92.00 per lockset
Abrasive coat inside only	M24	Add \$47.00 per lockset
Abrasive coat outside only	M25	Add \$47.00 per lockset
Lead lining (roses)	M28	Add \$178.00 per lockset
Lever to accept Schlage® LFIC (AZ, NZ & PZ designs) ²	M69	No Charge
Lever to accept Yale® 6-pin fixed core cylinder (NZ & PZ designs only) ²	YC	
Lever to accept Yale® 7-pin fixed core cylinder (NZ & PZ designs only) ²	YC7	
Lever to accept Yale® 6-pin LFIC (NZ & PZ designs only) ²	YRC	
Lever to accept Yale® 7-pin LFIC (NZ & PZ designs only) ²	YRC7	
STC 55 Acoustical Door Kit	M112	

Notes:

2. Not available in CL3129 function.

Grade 1 Extra Heavy Duty Cylindrical Lever Locksets

CL3300 Series

USA & Canada Prices Effective March 16, 2020

Standard Features

Handing

Non-handed except FZD

Door Thickness

1-3/4" - 2"

Backset

2-3/4"

Strike

ANSI curved lip
4-7/8" x 1-1/4" x 1-1/4" lip to center

Cylinder

Brass, 6-pin, L4 keyway, 0-bitted

Keys

Two nickel silver keys

Case Quantity

6

Case Weight

32 lbs

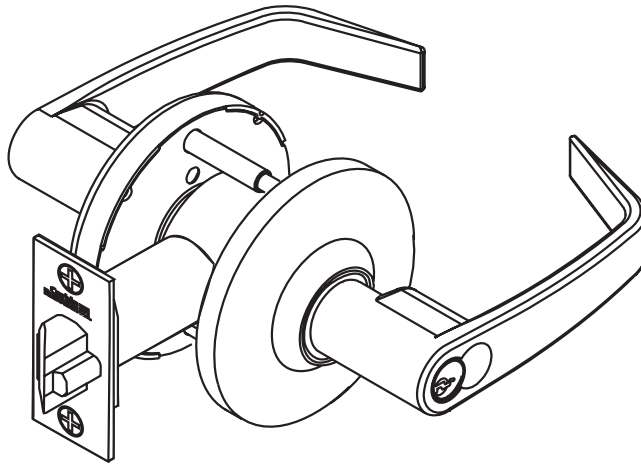

Ordering Examples

Stock Order

Quantity	Series/Function	Trim	Finish	Hand
100	CL3355	NZD	626	RHR

Split Trim/Split Finish Order

Quantity	Series/Function	Trim		Finish		Hand
		Outside	Inside	Outside	Inside	
12	CL3355	NZD	AZD	626	625	RHR

Contract/Detailed Order

Quantity	Keyset	Series/Function	Trim	Finish	Hand	Strike	Misc. Options	Cylinder and Keying
24	AA1	CL3355	NZD	626	RHR	SA112	M17	C6-VKC3

Lever Designs: AZD, NZD, PZD, FZD



Lever:

Die cast zinc

Rose:

Wrought Brass

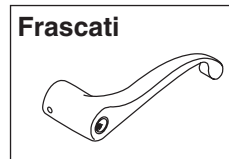
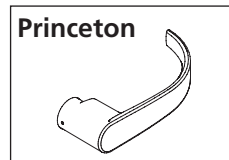
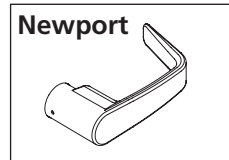

Function	Description		AZD, NZD, PZD, FZD	
			Finish: 613E, 626, BSP, WSP	Finish: 605, 606, 611, 612, 613, 613L, 618, 619, 625, 722
CL3310	Non-Keyed	Passage	\$525.00	\$541.00
CL3380		Passage x Blank Plate	\$581.00	\$597.00
CL3390		Passage x Turnpiece		
CL3320		Privacy	\$680.00	\$696.00
CL3320H		Hospital Privacy		
CL3320TO		Time Out Lock	\$581.00	\$597.00
CL3340		Patio		
CL3340NT		Exit Latch	\$211.00	\$219.00
CL3350		Half Dummy		
CL3370		Full Dummy	\$423.00	\$439.00
CL3351	Single Cylinder	Entrance	\$680.00	\$696.00
CL3355		Classroom		
CL3357		Storeroom		
CL3359		Storeroom or Public Restroom	\$695.00	\$711.00
CL3361		Entrance		
CL3375		Corridor/Dormitory	\$755.00	\$771.00
CL3393		Service Station		
CL3329		Hotel		
CL3381		Keyed x Blank Plate	\$680.00	\$696.00
CL3391		Keyed x Blank Plate		
CL3332	Double Cylinder	Institution	\$782.00	\$798.00
CL3352		Classroom Intruder		
CL3362		Communicating		
CL3372		Public Toilet		
CL33903*	Electrified	Fail Safe	\$905.00	\$921.00
CL33905*		Fail Secure		



***ElectroLynx®**

As part of their promise to provide innovative, fast and effective, and higher security solutions to their customers, ASSA ABLOY Group companies offer ElectroLynx, a universal quick-connect system that simplifies the electrification of the door opening. ElectroLynx® is a registered trademark of ASSA ABLOY, Inc.

Grade 1 Extra Heavy Duty Cylindrical Lever Locksets

CL3300 Series

USA & Canada Prices Effective March 16, 2020

Cylinder Options

Description	Specify Quick Code	Add or Deduct
Conventional 6-pin	(standard)	No Charge
Conventional 7-pin	7P	Add \$2.00 per cylinder
Less Cylinder ⁴	LC	Deduct \$93.00 per cylinder
Access 3 Patented	AP	No Charge
Access 3 Security	AS	Add \$61.00 per cylinder
Access 3 High Security, UL 437	AHS	Add \$86.00 per cylinder
Access 3 IC Patented	ACP	Add \$80.00 per cylinder
Access 3 IC Security	ACS	Add \$132.00 per cylinder
Access 3 IC High Security, UL 437	ACHS	Add \$153.00 per cylinder
Pyramid Security Fixed Core ³	PS	Add \$64.00 per cylinder
Pyramid Security IC ³	PCS	Add \$140.00 per cylinder
Pyramid High Security Fixed Core ³	PHS	Add \$94.00 per cylinder
Pyramid High Security IC ³	PCHS	Add \$171.00 per cylinder
Pyramid IC with Temporary Construction Core	CTP	Add \$80.00 per cylinder
Pyramid IC with Temporary Disposable Core	CTPD	No Charge
Pyramid IC Less Core	CLP	No Charge
Security ³	HS	Add \$119.00 per cylinder
Security IC ³	CHS	Add \$199.00 per cylinder
IC 6-pin	C6	Add \$80.00 per cylinder
IC 6-pin with Temporary Construction Core (Red)	CT6R	Add \$80.00 per cylinder
IC 6-pin with Temporary Construction Core (Blue)	CT6B	Add \$80.00 per cylinder
IC 6-pin with Temporary Construction Core (Green)	CT6G	Add \$80.00 per cylinder
IC 6-pin with Temporary Disposable Core	CT6D	No Charge
Small Format Temporary Disposable Core	CTSD	No Charge
IC 6-pin Less Core ³	CL6	No Charge
IC 7-pin	C7	Add \$82.00 per cylinder
IC 7-pin with Temporary Construction Core (Red)	CT7R	Add \$82.00 per cylinder
IC 7-pin with Temporary Construction Core (Blue)	CT7B	Add \$82.00 per cylinder
IC 7-pin with Temporary Construction Core (Green)	CT7G	Add \$82.00 per cylinder
IC 7-pin with Temporary Disposable Core	CT7D	No Charge
IC 7-pin Less Core ³	CL7	
Lockset furnished in Schlage® C Keyway ^{1,3}	C	
Lockset furnished in Sargent® LA Keyway ^{2,3}	LA	

Notes:

1. Available 0-bitted & key random (KR) only.
2. Available 0-bitted only.
3. Not available in CL3329 function.
4. CL3329 function is not available less cylinder.

Keying Options*

Description	Specify Quick Code	Add or Deduct
0-Bitted with 2 blank keys	(standard)	No Charge
Keyed random	KR	
Master keyed (all cylinders except 8000, 8020, 8027 IC core)	Specify keyset	Add \$16.00 per cylinder
Master keyed Pyramid	Specify keyset	
Master keyed Security (including IC cylinder and core)	Specify keyset	
Master keyed (8000, 8020, 8027 IC core)	Specify keyset	No Charge
Master keyed to customer bittings or sample key	Specify keyset	Add \$16.00 per cylinder
Construction master keyed ^{1,2}	CMK	Add \$16.00 per cylinder
Visual key control (VKC)		
-No stamping	VKC0	\$4.50
-Keys only	VKC1	No Charge
-Cylinder and Keys ³	VKC2	\$8.00
-Cylinders only ³	VKC3	\$8.00
Concealed key control (CKC)		
-CKC cylinders with VKC keys	CKC2	\$8.00
-CKC cylinders only ³	CKC3	\$8.00
More than 2 keys per lock	KY# (e.g., KY6)	See page 31 - Cut Keys Section

Notes:

1. CMK Construction master keying charge is in addition to master keying charge.
2. CMK Construction master keying is not available in interchangeable core, Access 3, Pyramid, or Security series.
3. VKC2, VKC3, CKC3 are not available in Access 3, Pyramid or Security series.

*Double cylinder keying: unless otherwise specified, both cylinders of 32 and 82 functions will be keyed alike. The inside cylinder of 72 function will be keyed to the master key(s) only, while the outside cylinder will include the change key.

If different keying is required, specify outside cylinder first, then inside cylinder.

For key bows other than 10 and 90, specify 'KB' + bow number as Quick Code, e.g. KB12.

Door Thickness Options

Description	Specify Quick Code	Add or Deduct
1-3/4" - 2"	(standard)	No Charge
Over 2" up to 2-1/4"	D214	

Backset Options

Description	Specify Quick Code	Add or Deduct
2-3/4"	(standard)	No Charge
3-3/4"	B334	Add \$15.00 to lockset
5"	B500	Add \$24.00 to lockset

Strike Options* (to purchase strike separately, see catalog or parts manual for part no.)

Lip Length	ANSI Curved Lip - Specify Quick Code	Curved Lip Box - Specify Quick Code	Add or Deduct
1"	SA100	SC100	No Charge
1-1/8"	SA118	SC118	
1-1/4"	(standard)	SC114	
1-3/8"	SA138	SC138	
1-1/2"	SA112	SC112	Add \$17.00 per lockset
1-3/4"	SA134	SC134	
2"	SA200	SC200	
2-1/4"	SA214	SC214	
2-1/2"	SA212	SC212	
2-3/4"	SA234	SC234	
3"	SA300	SC300	

Description	Specify Quick Code	Add or Deduct
Rabbeted front and strike	SR118	Add \$90.00 per lockset

*If door thickness is standard or has been specified and no special door or frame condition exist, then only the first two characters of the optional strike Quick Code must be specified (e.g. "SC").
The correct lip length will be determined by our order entry system based on the standard or specified door thickness.

Miscellaneous Options

Description	Specify Quick Code	Add or Deduct
Split designs and split finishes	Outside Trim x Inside Trim	Higher set price prevails
Spanner head screws	M02	Add \$21.00 per lockset
Torx® head screws	M04	Add \$26.00 per lockset
Less cylinder and with tailpiece for Schlage® fixed core cylinder (all designs) ²	M06	No Charge
Lever to accept 6 or 7-pin SFIC ² (NZD, FZD and PZD designs only)	M08	No Charge
Lever to accept Sargent® fixed core cylinder (all designs) ²	M09	No Charge
1-1/8" latch front, rounded corners	M13	Add \$2.50 per latch
3/4" throw fire latch x 2-3/4" backset (not available for CL3320, 29, 40, and 93 functions) Finishes Matching Available Lock Finish 605 605 606 606, 611, 612, 613 626 625, 626	M16	Add \$100.00 per lockset
ANSI wrought strike box	M17	No Charge
Knurling outside and inside	M20	Add \$148.00 per lockset
Knurling outside only	M21	Add \$75.00 per lockset
Knurling inside only	M22	Add \$75.00 per lockset
Abrasive coat outside and inside	M23	Add \$92.00 per lockset
Abrasive coat inside only	M24	Add \$47.00 per lockset
Abrasive coat outside only	M25	Add \$47.00 per lockset
Lead lining (roses)	M28	Add \$178.00 per lockset
Lever to accept Schlage® LFIC ² (NZD and PZD designs only)	M69	No Charge
Request to Exit (REX) Switch (CL33900 only)	M92	\$202.00
CL33900 Series electrified options		
12VAC/DC ¹	12 AD	No Charge
24VAC/DC	24 AD	

Notes:

1. Voltage is universal for AC or DC current.
2. Not available in CL3329 function.

Standard Features

Handing

Non-handed

Door Thickness

1-3/4"

Backset

2-3/4"

Strike

ANSI curved lip
4-7/8" x 1-1/4" x 1-1/4" lip to center

Cylinder

Brass, 6-pin, L4 keyway
0-bitted

Keys

Two nickel silver keys

Case Quantity

6

Case Weight

26 lbs

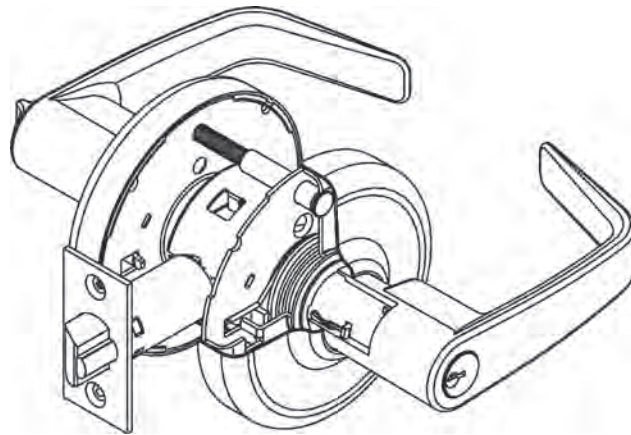

Ordering Examples

Stock Order

Quantity	Series/Function	Trim	Finish	Hand
100	CL3555	NZD	626	RH

Split Trim/Split Finish Order

Quantity	Series/Function	Trim		Finish		Hand
		Outside	Inside	Outside	Inside	
12	CL3555	NZD	AZD	626	625	RH

Contract/Detailed Order

Quantity	Keyset	Series/Function	Trim	Finish	Hand	Strike	Misc. Options	Cylinder and Keying
24	AA1	CL3555	NZD	626	RH	SA112	M17	C6-VKC3

Lever Designs: AZD



Lever:

Die cast zinc

Rose:

Wrought Brass



AZD

Armstrong

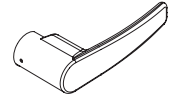

Lever Designs: NZD



Lever:

Die cast zinc

Rose:

Wrought Brass



NZD

Newport



Princeton



Lever Designs: PZD



Lever:

Die cast zinc

Rose:

Wrought Brass



PZD

Function	Description		AZD, NZD, PZD	
			Finish: 613E, 626, BSP, WSP	Finish: 605, 606, 611, 612, 613, 613L, 618, 619, 625, 722
CL3510	Non-Keyed	Passage	\$487.00	\$503.00
CL3580		Passage x Blank Plate	\$531.00	\$547.00
CL3520		Privacy		
CL3550		Half Dummy		
CL3570		Full Dummy	\$211.00	\$219.00
CL3551	Single Cylinder	Entrance	\$595.00	\$611.00
CL3555		Classroom		
CL3557		Storeroom		
CL3561		Office or Entrance		
CL3581		Keyed x Blank Plate		
CL3582	Double Cylinder	Store Door	\$681.00	\$697.00

Cylinder Options

Description	Specify Quick Code	Add or Deduct
Conventional 6-pin	(standard)	No Charge
Conventional 7-pin	7P	Add \$2.00 per cylinder
Less Cylinder	LC	Deduct \$93.00 per cylinder
Access 3 Patented	AP	No Charge
Access 3 Security	AS	Add \$61.00 per cylinder
Access 3 High Security, UL 437	AHS	Add \$86.00 per cylinder
Access 3 IC Patented	ACP	Add \$80.00 per cylinder
Access 3 IC Security	ACS	Add \$132.00 per cylinder
Access 3 IC High Security, UL 437	ACHS	Add \$153.00 per cylinder
Pyramid Security Fixed Core	PS	Add \$64.00 per cylinder
Pyramid Security IC	PCS	Add \$140.00 per cylinder
Pyramid High Security Fixed Core	PHS	Add \$94.00 per cylinder
Pyramid High Security IC	PCHS	Add \$171.00 per cylinder
Pyramid IC with Temporary Construction Core	CTP	Add \$80.00 per cylinder
Pyramid IC with Temporary Disposable Core	CTPD	No Charge
Pyramid IC Less Core	CLP	No Charge
Security	HS	Add \$119.00 per cylinder
Security IC	CHS	Add \$199.00 per cylinder
IC 6-pin	C6	Add \$80.00 per cylinder
IC 6-pin with Temporary Construction Core (Red)	CT6R	Add \$80.00 per cylinder
IC 6-pin with Temporary Construction Core (Blue)	CT6B	Add \$80.00 per cylinder
IC 6-pin with Temporary Construction Core (Green)	CT6G	Add \$80.00 per cylinder
IC 6-pin with Temporary Disposable Core	CT6D	No Charge
Small Format Temporary Disposable Core	CTSD	No Charge
IC 6-pin less core	CL6	No Charge
IC 7-pin	C7	Add \$82.00 per cylinder
IC 7-pin with Temporary Construction Core (Red)	CT7R	Add \$82.00 per cylinder
IC 7-pin with Temporary Construction Core (Blue)	CT7B	Add \$82.00 per cylinder
IC 7-pin with Temporary Construction Core (Green)	CT7G	Add \$82.00 per cylinder
IC 7-pin with Temporary Disposable Core	CT7D	No Charge
IC 7-pin Less Core	CL7	No Charge
Lockset furnished in Schlage® C Keyway ¹	C	
Lockset furnished in Sargent® LA Keyway ²	LA	

Notes:

1. Available 0-bitted & key random (KR) only.
2. Available 0-bitted only.

Keying Options*

Description	Specify Quick Code	Add or Deduct
0-Bitted with 2 blank keys	(standard)	No Charge
Keyed random	KR	
Master keyed (all cylinders except 8000, 8020, 8027 IC core)	Specify keyset	Add \$16.00 per cylinder
Master keyed Pyramid	Specify keyset	
Master keyed Security (including IC cylinder and core)	Specify keyset	
Master keyed (8000, 8020, 8027 IC core)	Specify keyset	No Charge
Master keyed to customer bittings or sample key	Specify keyset	Add \$16.00 per cylinder
Construction master keyed ^{1,2}	CMK	Add \$16.00 per cylinder
Visual key control (VKC)		
-No stamping	VKC0	\$4.50
-Keys only	VKC1	No Charge
-Cylinder and Keys ³	VKC2	\$8.00
-Cylinders only ³	VKC3	\$8.00
Concealed key control (CKC)		
-CKC cylinders with VKC keys	CKC2	\$8.00
-CKC cylinders only ³	CKC3	\$8.00
More than 2 keys per lock	KY# (e.g., KY6)	See page 31 - Cut Keys Section

Notes:

1. CMK Construction master keying charge is in addition to master keying charge.
2. CMK Construction master keying is not available in interchangeable core, Access 3, Pyramid, or Security series.
3. VKC2, VKC3, CKC3 are not available in Access 3, Pyramid or Security series.

*Double cylinder keying: unless otherwise specified, both cylinders of 82 functions will be keyed alike.

If different keying is required, specify outside cylinder first, then inside cylinder.

For key bows other than 10 and 90, specify "KB" + bow number as Quick Code, e.g. KB12.

Door Thickness Options

Description	Specify Quick Code	Add or Deduct
1-3/4"	(standard)	No Charge
1-3/8"	D138**1	

Backset Options

Description	Specify Quick Code	Add or Deduct
2-3/8"	B238 ¹	No Charge
2-3/4"	B234 (standard)	
3-3/4"	B334	Add \$15.00 to lockset
5"	B500	Add \$24.00 to lockset

Strike Options* (to purchase strike separately, see catalog or parts manual for part no.)

Lip Length	ANSI Curved Lip Specify Quick Code	Curved Lip Box Specify Quick Code	Full Lip Specify Quick Code	Add or Deduct
1"	SA100	SC100		No Charge
1-1/8"	SA118	SC118	SF118	
1-1/4"	(standard)	SC114		
1-3/8"	SA138	SC138		
1-1/2"	SA112	SC112		Add \$17.00 per lockset
1-3/4"	SA134	SC134		
2"	SA200	SC200		
2-1/4"	SA214	SC214		
2-1/2"	SA212	SC212		
2-3/4"	SA234	SC234		
3"	SA300	SC300		

Description	Specify Quick Code	Add or Deduct
Rabbeted front and strike	SR118	Add \$90.00 per lockset

*If door thickness is standard or has been specified and no special door or frame condition exist, then only the first two characters of the optional strike Quick Code must be specified (e.g. "SC").

The correct lip length will be determined by our order entry system based on the standard or specified door thickness.

**If D138 is specified, 2-3/8" backset latch will be supplied unless B234 option is also specified.

1. M14 and B238 (2-3/8" backset) standard with D138 (1-3/8" door thickness) option.

Miscellaneous Options

Description	Specify Quick Code	Add or Deduct
Split designs and split finishes	Outside Trim x Inside Trim	Higher set price prevails
Spanner head screws	M02	Add \$21.00 per lockset
Torx® head screws	M04	Add \$26.00 per lockset
Less cylinder and with tailpiece for Schlage® fixed core cylinder (all designs)	M06	No Charge
Lever to accept 6 or 7-pin SFIC (NZD & PZD design only)	M08	No Charge
Lever to accept Sargent® fixed core cylinder (all designs) (NZD design only)	M09	No Charge
Lever to accept Schlage® LFIC (NZD & PZD design only)	M69	No Charge
1-1/8" latch front, rounded corners	M13	Add \$2.50 per latch
1" latch front, square corners ¹	M14	Add \$6.00 per lockset
1" latch front, rounded corners	M15	Add \$2.50 per latch
ANSI wrought strike box	M17	No Charge
Knurling outside and inside	M20	Add \$148.00 per lockset
Knurling outside only	M21	Add \$75.00 per lockset
Knurling inside only	M22	Add \$75.00 per lockset
Abrasive coat outside and inside only	M23	Add \$92.00 per lockset
Abrasive coat inside only	M24	Add \$47.00 per lockset
Abrasive coat outside only	M25	Add \$47.00 per lockset
1-1/8" latch front, square corners (standard for 2-3/4" and 5" backsets)	M32	No Charge

Note:

1. M14 and B238 (2-3/8" backset) standard with D138 (1-3/8" door thickness) option.

Standard Features

Handing

Non-handed

Door Thickness

1-3/8" - 1-7/8"

Available in 2" - 2-1/4" upon request

Backset

2-3/4" standard

Strike

ANSI curved lip
4-7/8" x 1-1/4" x 1-1/4" lip to center

Cylinder

Brass, 6-pin, L4 keyway
0-bitted

Keys

Two nickel silver keys

Case Quantity

6

Case Weight

32 lbs

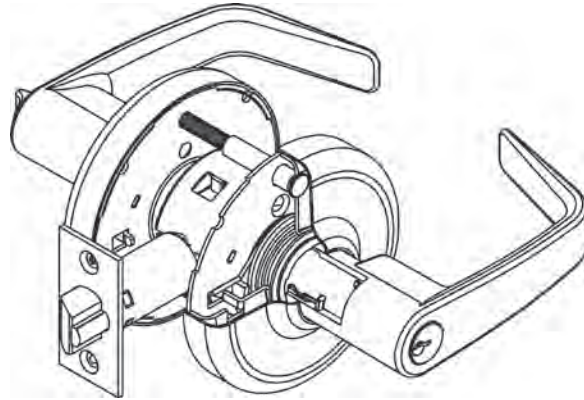

Ordering Examples

Stock Order

Quantity	Series/Function	Trim	Finish	Hand
100	CL3855	NZD	626	RHR

Split Trim/Split Finish Order

Quantity	Series/Function	Trim		Finish		Hand
		Outside	Inside	Outside	Inside	
12	CL3855	NZD	AZD	626	625	RHR

Contract/Detailed Order

Quantity	Keyset	Series/Function	Trim	Finish	Hand	Strike	Misc. Options	Cylinder and Keying
24	AA1	CL3855	NZD	626	RHR	SA112	M02	C6-VKC3

Lever Designs: AZD, NZD, PZD



Lever:
Die cast zinc

Rose:
Wrought Brass

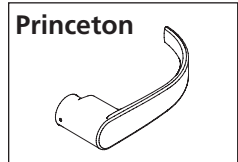
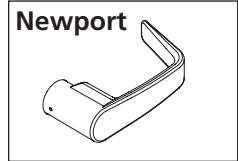
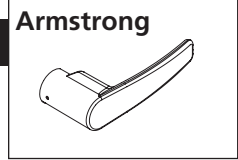

Function	Description		AZD, NZD, PZD	
			Finish: 613E, 626, BSP, WSP	Finish: 605, 606, 611, 612, 613, 613L, 618, 619, 625, 722
CL3810	Non-Keyed	Passage	\$223.00	\$239.00
CL3880		Passage x Blank Plate	\$243.00	\$259.00
CL3820		Privacy		
CL3850		Half Dummy		
CL3870		Full Dummy	\$235.00	\$251.00
CL3851	Single Cylinder	Entrance	\$299.00	\$315.00
CL3855		Classroom		
CL3857		Storeroom		
CL3861		Office		

Cylinder & Keying Options

Description	Specify Quick Code	Add or Deduct
Conventional 6-pin	(standard)	No Charge
Conventional 7-Pin	7P	Add \$2.00 per cylinder
Less Cylinder	LC	Deduct \$93.00 per cylinder
Access 3 Patented	AP	No Charge
Access 3 Security	AS	Add \$61.00 per cylinder
Access 3 High Security, UL 437	AHS	Add \$86.00 per cylinder
Access 3 IC Patented	ACP	Add \$80.00 per cylinder
Access 3 IC Security	ACS	Add \$132.00 per cylinder
Access 3 IC High Security, UL 437	ACHS	Add \$153.00 per cylinder
Pyramid Security Fixed Core ³	PS	Add \$64.00 per cylinder
Pyramid Security IC ³	PCS	Add \$140.00 per cylinder
Pyramid High Security Fixed Core ³	PHS	Add \$94.00 per cylinder
Pyramid High Security IC ³	PCHS	Add \$171.00 per cylinder
Pyramid IC with Temporary Construction Core	CTP	Add \$80.00 per cylinder
Pyramid IC with Temporary Disposable Core	CTPD	No Charge
Pyramid IC Less Core	CLP	No Charge
Security	HS	Add \$119.00 per cylinder
Security IC	CHS	Add \$199.00 per cylinder
IC 6-pin	C6	Add \$80.00 per cylinder
IC 6-pin with Temporary Construction Core (Red)	CT6R	Add \$80.00 per cylinder
IC 6-pin with Temporary Construction Core (Blue)	CT6B	Add \$80.00 per cylinder
IC 6-pin with Temporary Construction Core (Green)	CT6G	Add \$80.00 per cylinder
IC 6-pin with Temporary Disposable Core	CT6D	No Charge
Small Format Temporary Disposable Core	CTSD	No Charge
IC 6-pin Less Core	CL6	No Charge
IC 7-Pin	C7	Add \$82.00 per cylinder
IC 7-Pin with Temporary Construction Core (Red)	CT7R	Add \$82.00 per cylinder
IC 7-Pin with Temporary Construction Core (Blue)	CT7B	Add \$82.00 per cylinder
IC 7-Pin with Temporary Construction Core (Green)	CT7G	Add \$82.00 per cylinder
IC 7-Pin with Temporary Disposable Core	CT7D	No Charge
IC 7-Pin Less Core	CL7	No Charge
Lockset furnished in Schlage® C Keyway ¹	C	No Charge
Lockset furnished in SARGENT® LA Keyway ²	LA	No Charge
0-Bitted with 2 blank keys	(standard)	No Charge
Keyed random	KR	
Master keyed (all cylinders except 8000, 8020, 8027 IC core)	Specify keyset	Add \$16.00 per cylinder
Master keyed Pyramid	Specify keyset	
Master keyed Security (including IC cylinder and core)	Specify keyset	
Master keyed (8000, 8020, 8027 IC core)	Specify keyset	No Charge
Master keyed to customer bittings or sample key	Specify keyset	Add \$16.00 per cylinder
Construction master keyed ^{3,4}	CMK	Add \$16.00 per cylinder
Visual key control (VKC)		
-No stamping	VKC0	\$4.50
-Keys only	VKC1	No Charge
-Cylinder and Keys ⁵	VKC2	\$8.00
-Cylinders only ⁵	VKC3	\$8.00
Concealed key control (CKC)		
-CKC cylinders with VKC keys	CKC2	\$8.00
-CKC cylinders only ³	CKC3	\$8.00
More than 2 keys per lock	KY# (e.g., KY6)	See page 66 - Cut Keys Section

Notes:

1. Available 0-bitted & key random (KR) only.
 2. Available 0-bitted only.
 3. CMK Construction master keying charge is in addition to master keying charge.
 4. CMK Construction master keying is not available in interchangeable core, Access 3, Pyramid, or Security series.
 5. VKC2, VKC3, CKC3 are not available in Access 3, Pyramid or Security series.
- For key bows other than 10 and 90, specify "KB" + bow number as Quick Code, e.g. KB12. No extra charge.

Door Thickness Options

Description	Specify Quick Code	Add or Deduct
1-3/8" — 1-7/8"	(standard)	No Charge
2" — 2-1/4"	D214	Add \$5.00 per lockset

Backset Options

Description	Specify Quick Code	Add or Deduct
2-3/8"	B238 ¹	No Charge
2-3/4"	(standard)	
3-3/4"	B334	Add \$12.00 to lockset
5"	B500	Add \$14.00 to lockset

Strike Options* (to purchase strike separately, see catalog or parts manual for part no.)

Lip Length	ANSI Curved Lip Specify Quick Code	Curved Lip Box Specify Quick Code	Full Lip Specify Quick Code	Full Lip Radius Corner Specify Quick Code	Add or Deduct
1"	SA100	SC100			No Charge
1-1/8"	SA118	SC118			
1-1/4"	(standard)	SC114	SF114	SFR114	
1-3/8"	SA138	SC138			
1-1/2"	SA112	SC112			Add \$17.00 per lockset
1-3/4"	SA134	SC134			
2"	SA200	SC200			
2-1/4"	SA214	SC214			
2-1/2"	SA212	SC212			
2-3/4"	SA234	SC234			
3"	SA300	SC300			

*If door thickness is standard or has been specified and no special door or frame condition exist, then only the first two characters of the optional strike Quick Code must be specified (e.g. "SC").
The correct lip length will be determined by our order entry system based on the standard or specified door thickness.

Miscellaneous Options

Description	Specify Quick Code	Add or Deduct
Split designs and split finishes	Outside Trim x Inside Trim	Higher set price prevails
Spanner head screws	M02	Add \$21.00 per lockset
Torx® head screws	M04	Add \$26.00 per lockset
Less cylinder and with tailpiece for Schlage® fixed core cylinder (all designs)	M06	No Charge
Lever to accept 6 or 7-pin SFIC (FZD, NZD & PZD design only)	M08	No Charge
Lever to accept Sargent® fixed core cylinder (all designs) (NZD & PZD design only)	M09	No Charge
1-1/8" latch front, rounded corners	M13	Add \$2.50 per latch
1" latch front, square corners ¹	M14	Add \$6.00 per lockset
1" latch front, rounded corners	M15	Add \$2.50 per latch
ANSI wrought strike box	M17	No Charge
Knurling outside and inside	M20	Add \$148.00 per lockset
Knurling outside only	M21	Add \$75.00 per lockset
Knurling inside only	M22	Add \$75.00 per lockset
Abrasive coat outside and inside only	M23	Add \$92.00 per lockset
Abrasive coat inside only	M24	Add \$47.00 per lockset
Abrasive coat outside only	M25	Add \$47.00 per lockset
1-1/8" latch front, square corners (standard for 2-3/4" and 5" backsets)	M32	No Charge
Lever to accept Schlage® LFIC (NZD & PZD designs only)	M69	No Charge

Note:

1. M14 and B238 (2-3/8" backset) standard with D138 (1-3/8" door thickness) option.

Standard Features

Handing

Field reversible

Door Thickness

1-3/4" - 2"

Backset

2-3/4"

Strike

ANSI curved lip 4-7/8" - 1-1/4" x
1-1/4" lip to center

Cylinder

Brass, 6-pin, L4 keyway
0-bitted

Keys

Two nickel silver keys

Case Quantity

10

Case Weight

32 lbs

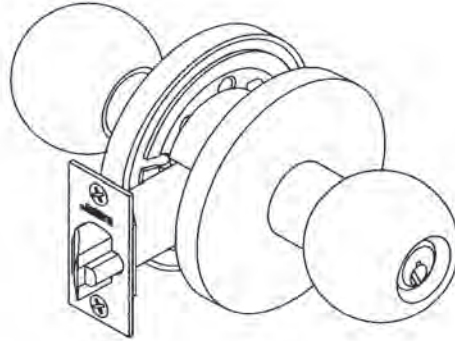

Ordering Example

Stock Order

Quantity	Series/Function	Trim	Finish	Hand
100	CK4355	GRD	630	RHR

Contract/Detailed Order

Quantity	Keyset	Series/Function	Trim	Finish	Hand	Strike	Misc. Options	Cylinder and Keying
24	AA1	CK4355	GRD	630	RHR	SA112	M02	VK3

Knob Designs: GRD
Knob:
Wrought
Reinforced

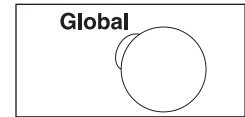
Rose:
Wrought
Reinforced

Function	Description		GRD
			Finish: 605, 613E, 630
CK4310	Non-Keyed	Passage	\$632.00
CK4320		Privacy	\$710.00
CK4350		Half Dummy	\$272.00
CK4351	Single Cylinder	Entrance	\$785.00
CK4355		Classroom	
CK4357		Storeroom	
CK4332	Double Cylinder	Institution	\$855.00

Cylinder Options

Description	Specify Quick Code	Add or Deduct
Conventional 6-pin	(standard)	No Charge
Less (1) Cylinder	LC	Add \$93.00 per cylinder
Access 3 Patented	AP	No Charge
Access 3 Security	AS	Add \$61.00 per cylinder
Access 3 High Security, UL 437	AHS	Add \$86.00 per cylinder
Pyramid Security Fixed Core	PS	Add \$64.00 per cylinder
Pyramid High Security Fixed Core	PHS	Add \$94.00 per cylinder
Security	HS	Add \$119.00 per cylinder

Keying Options*

Description	Specify Quick Code	Add or Deduct
0-Bitted with 2 blank keys	(standard)	No Charge
Keyed random	KR	
Master keyed	Specify keyset	Add \$16.00 per cylinder
Master keyed Pyramid	Specify keyset	Add \$16.00 per cylinder
Master keyed Security	Specify keyset	Add \$16.00 per cylinder
Master keyed	Specify keyset	No Charge
Master keyed to customer bittings or sample key	Specify keyset	Add \$16.00 per cylinder
Construction master keyed ^{1,2}	CMK	Add \$16.00 per cylinder
Visual key control (VKC)		
-No stamping	VKC0	\$4.50
-Keys only	VKC1	No Charge
-Cylinder and Keys ³	VKC2	\$8.00
-Cylinders only ³	VKC3	\$8.00
Concealed key control (CKC)		
-CKC cylinders with VKC keys	CKC2	\$8.00
-CKC cylinders only ³	CKC3	\$8.00
More than 2 keys per lock	KY# (e.g., KY6)	See page 66 - Cut Keys Section

Notes:

1. CMK Construction master keying charge is in addition to master keying charge.
2. CMK Construction master keying is not available in interchangeable core, Access 3, Pyramid, or Security series.
3. VKC2, VKC3, CKC3 are not available in Access 3, Pyramid or Security series.

*Double cylinder keying: unless otherwise specified, both cylinders of 32 functions will be keyed alike. If different keying is required, specify outside cylinder first, then inside cylinder. For key bows other than 10 and 90, specify "KB" + bow number as Quick Code, e.g. KB12. No extra charge.

Strike Options*

To purchase strike separately, see catalog or parts manual for part number.

Lip Length	ANSI Curved Lip - Specify Quick Code	Curved Lip Box - Specify Quick Code	Add or Deduct
1"	SA100	SC100	No Charge
1-1/8"	SA118	SC118	
1-1/4"	(standard)	SC114	
1-3/8"	SA138	SC138	
1-1/2"	SA112	SC112	
1-3/4"	SA134	SC134	Add \$17.00 per lockset
2"	SA200	SC200	
2-1/4"	SA214	SC214	
2-1/2"	SA212	SC212	
2-3/4"	SA234	SC234	
3"	SA300	SC300	

*If door thickness is standard or has been specified and no special door or frame condition exist, then only the first two characters of the optional strike Quick code must be specified(e.g. "SC").
The correct lip length will be determined by our order entry system based on the standard or specified door thickness.

Backset Options

Description	Specify Quick Code	Add or Deduct
2-3/4"	(standard)	No Charge

Door Thickness Options

Description	Specify Quick Code	Add or Deduct
1-3/4" - 2"	(standard)	No Charge

Miscellaneous Options

Description	Specify Quick Code	Add or Deduct
Spanner head screws	M02	Add \$21.00 per lockset
Torx® head screws	M04	Add \$26.00 per lockset
ANSI wrought strike box	M17	No Charge

Standard Features

Handing

Field reversible

Door Thickness

1-3/8" - 1-3/4"

Backset

2-3/4"

Strike

ANSI curved Lip 4-7/8" x 1-1/4"
x 1-1/4" lip to center

Cylinder

Brass, 6-pin, L4 keyway,
0-bitted

Keys

Two nickel silver keys

Case Quantity

20

Case Weight

40 lbs

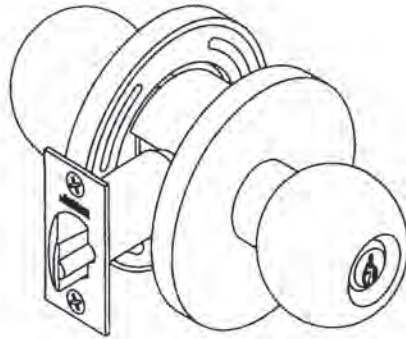

Ordering Example

Stock Order

Quantity	Series/Function	Trim	Finish	Hand
100	CK4451	GWC	630	RHR

Split Trim/Split Finish Order (Privacy function CK4430 only: inside finish 629 only)

Quantity	Series/Function	Finish	Finish		Hand
			Outside	Inside	
12	CK4430	GWC	605	629	RHR

Contract/Detailed Order

Quantity	Keyset	Series/Function	Trim	Finish	Hand	Strike	Misc. Options	Cylinder and Keying
24	AA1	CK4451	GWC	630	RHR	SA200	M17	VKC1

Knob Designs: GWC
Knob:
Wrought

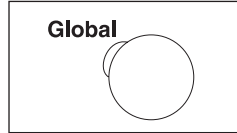
Rose:
Wrought
Reinforced

Function	Description		GWC	
			Finish: 630	Finish: 605, 612, 613, 629
CK4410	Non-Keyed	Passage	\$213.00	\$229.00
CK4480		Communicating		
CK4430		Privacy	\$232.00	\$248.00
CK4440		Patio		
CK4450		Half Dummy	\$184.00	\$192.00
CK4451	Single Cylinder	Entrance	\$290.00	\$306.00
CK4455		Classroom		
CK4457		Storeroom		
CK4429		Hotel		
CK4482	Double Cylinder	Storeroom	\$376.00	\$392.00

Cylinder & Keying Options*

Description	Specify Quick Code	Add or Deduct
Conventional 6-pin	(standard)	No Charge
Less (1) cylinder	LC	Deduct \$93.00 per cylinder
Less hotel cylinder	LC	Deduct \$96.00
0-Bitted with 2 blank keys	(standard)	No Charge
Keyed random	KR	No Charge
Master keyed*	specify keyset	Add \$16.00 per cylinder
Master keyed to customer bittings or sample key	specify keyset	Add \$16.00 per cylinder
Construction master keyed ¹	CMK	Add \$16.00 per cylinder
Visual key control (VKC)		
-No stamping	VKC0	\$4.50
-Keys only	VKC1	No Charge
Concealed key control (CKC)		
-CKC cylinders with VKC keys	CKC2	\$8.00
-CKC cylinders only	CKC3	\$8.00
More than 2 keys per lock	KY# (e.g., KY6)	See page 31 - Cut Keys Section

Notes:

1. CMK Construction master keying charge is in addition to master keying charge.

*Both cylinders of double cylinder function locksets will be keyed alike, unless otherwise specified.

If different keying is required, specify outside cylinder first, then inside cylinder.

For key bows other than 10 and 90, specify "KB" + bow number as Quick Code, e.g. KB12. No extra charge.

Backset Options

Description	Specify Quick Code	Add or Deduct
2-3/8"	B238	No Charge
2-3/4"	(standard)	
3-3/4"	B334	Add \$12.00 to lockset
5"	B500	Add \$14.00 to lockset

Strike Options*

To purchase strike separately, see catalog or parts manual for part no.

Strike Options* (to purchase strike separately, see catalog or parts manual for part no.)

Lip Length	ANSI Curved Lip Specify Quick Code	Curved Lip Box Specify Quick Code	Full Lip Specify Quick Code	Full Lip Radius Corner Specify Quick Code	Add or Deduct
1"	SA100	SC100			No Charge
1-1/8"	SA118	SC118			
1-1/4"	(standard)	SC114	SF114	SFR114	
1-3/8"	SA138	SC138			
1-1/2"	SA112	SC112			Add \$17.00 per lockset
1-3/4"	SA134	SC134			
2"	SA200	SC200			
2-1/4"	SA214	SC214			
2-1/2"	SA212	SC212			
2-3/4"	SA234	SC234			
3"	SA300	SC300			

*If door thickness is standard or has been specified and no special door or frame condition exist, then only the first two characters of the optional strike Quick Code must be specified (e.g. "SC").

Miscellaneous Options

Description	Specify Quick Code	Add or Deduct
Split designs and split finishes	Outside Trim x Inside Trim	Higher set price prevails
NOTE: Split finish on inside must be 629 for CK4430 only.		
1" latch front, square corners (for 2-3/8" backset only)	M14	Add \$6.00 per lockset
ANSI wrought strike box	M17	No Charge
Abrasive coat outside and inside	M23	Add \$92.00 per lockset
Abrasive coat inside only	M24	Add \$47.00 per lockset
Abrasive coat outside only	M25	Add \$47.00 per lockset

Blank Page

Pre-Assembled Unit Locksets:

UT5200 Series Standard Features & Ordering Examples	186
UT5200 Series Lever Designs	187
UT5200 Series Cylinder Options	188
UT5200 Series Keying Options	189
UT5200 Series Strike, Miscellaneous Options	190

PL5000 Series Padlocks:

PL5000 Series Standard Features & Ordering Example	191
PL5000 Series Cylinder & Keying, Miscellaneous Options	192

DL2200 Series Cylindrical Deadlocks:

DL2200 Series Standard Features & Ordering Example	193
DL2200 Series Cylinder & Keying Options	194
DL2200 Series Strike, Door Thickness, Miscellaneous Options	195

DL3000 Series Cylindrical Deadlocks:

DL3000 Series Standard Features & Ordering Example	196
DL3000 Series Cylinder & Keying Options	197
DL3000 Series Strike, Door Thickness, Miscellaneous Options	198

DL3200 Series Cylindrical Deadlocks:

DL3200 Series Standard Features & Ordering Example	199
DL3200 Series Cylinder & Keying Options	200
DL3200 Series Strike, Door Thickness, Miscellaneous Options	201

DL4100 Series Mortise Deadlocks:

DL4100 Series Standard Features & Ordering Example	202
DL4100 Series Cylinder & Keying Options	203
DL4100 Series Strike, Door Thickness, Miscellaneous Options	204

Standard Features

Handing

Specify hand

Door Thickness

1-3/4" only

Backset

2-3/4" only

Strike

ANSI curved lip 4-7/8" x 1-1/4"
x 1-1/4" lip to center

Cylinder

Brass, 6-pin, L4 keyway,
0-bitted

Keys

Two nickel silver keys

Case Quantity

6 leversets
9 knobsets

Case Quantity

36

Case Weight

223.2 lbs

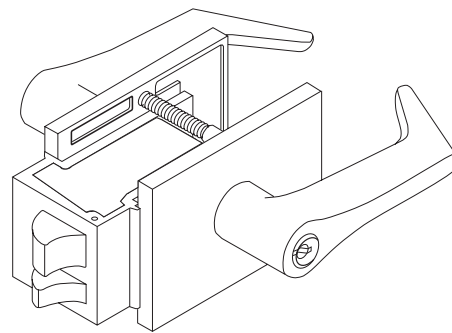

Now available with MicroShield® antimicrobial finish. Specify 626C finish (\$35.00 upcharge per lockset)

Ordering Example

Stock Order

Quantity	Series/Function	Trim	Finish	Hand
100	UT5251	ESE	626	RH

Split Trim/Split Finish Order

Quantity	Series/Function	Trim	Finish		Hand
			Outside	Inside	
12	UT5251	ESE	626	625	RHR

Contract/Detailed Order

Quantity	Keyset	Series/Function	Trim	Finish	Hand	Strike	Misc. Options	Cylinder and Keying
24	AA1	UT5251	ESE	626	RHR	SC200	M21	MR-VKC3

Lever Designs: ESE



Essex

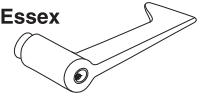

Lever:
Forged

Escutcheon:
Forged

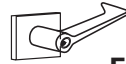

ESE

Function	Description		ESE
			Finish: 612, 613, 613E, 625, 626
UT5210	Non-keyed	Passage or Closet	\$1,347.00
UT5220		Privacy	\$1,429.00
UT5251	Single Cylinder	Entrance	\$1,515.00
UT5255		Classroom	
UT5257		Storeroom	
UT5282	Double Cylinder	Store Door	\$1,601.00

Cylinder Options

Description	Specify Quick Code	Add or Deduct
Conventional 6-pin	(standard)	No Charge
Less (1) Cylinder	LC	Deduct \$93.00 per cylinder
Access 3 Patented	AP	No Charge
Access 3 Security	AS	Add \$61.00 per cylinder
Access 3 High Security, UL 437	AHS	Add \$86.00 per cylinder
Access 3 IC Patented	ACP	Add \$80.00 per cylinder
Access 3 IC Security	ACS	Add \$132.00 per cylinder
Access 3 IC High Security, UL 437	ACHS	Add \$153.00 per cylinder
Pyramid Security Fixed Core	PS	Add \$64.00 per cylinder
Pyramid Security IC	PCS	Add \$140.00 per cylinder
Pyramid High Security Fixed Core	PHS	Add \$94.00 per cylinder
Pyramid High Security IC	PCHS	Add \$171.00 per cylinder
Pyramid IC with Temporary Construction Core	CTP	Add \$80.00 per cylinder
Pyramid IC with Temporary Disposable Core	CTPD	No Charge
Pyramid IC Less Core	CLP	No Charge
Security	HS	Add \$119.00 per cylinder
Security IC	CHS	Add \$199.00 per cylinder
IC 6-pin	C6	Add \$80.00 per cylinder
IC 6-pin with Temporary Construction Core (Red)	CT6R	Add \$80.00 per cylinder
IC 6-pin with Temporary Construction Core (Blue)	CT6B	Add \$80.00 per cylinder
IC 6-pin with Temporary Construction Core (Green)	CT6G	Add \$80.00 per cylinder
IC 6-pin with Temporary Disposable Core	CT6D	No Charge
IC 6-pin with Small Format Temporary Disposable Core	CTSD	No Charge
IC 6-pin Less Core	CL6	No Charge
IC 7-pin	C7	Add \$82.00 per cylinder
IC 7-pin with Temporary Construction Core (Red)	CT7R	Add \$82.00 per cylinder
IC 7-pin with Temporary Construction Core (Blue)	CT7B	Add \$82.00 per cylinder
IC 7-pin with Temporary Construction Core (Green)	CT7G	Add \$82.00 per cylinder
IC 7-pin with temporary Disposable Core	CT7D	No Charge
IC 7-pin Less Core	CL7	No Charge
Master Ring	MR	\$53.00

Keying Options*

Description	Specify Quick Code	Add or Deduct
0-Bitted with 2 blank keys	(standard)	No Charge
Keyed Random	KR	
Master keyed (all cylinders except 8000, 8020, 8027 IC core)	Specify keyset	Add \$16.00 per cylinder
Master keyed Pyramid	Specify keyset	
Master keyed Security (including IC cylinder and core)	Specify keyset	No Charge
Master keyed (8000, 8020, 8027 IC core)	Specify keyset	
Master keyed to customer bittings or sample key	Specify keyset	Add \$16.00 per cylinder
Construction master keyed ^{1,2}	CMK	Add \$16.00 per cylinder
Visual key control (VKC)		
-No stamping	VKC0	\$4.50
-Keys only	VKC1	No Charge
-Cylinder and Keys ³	VKC2	\$8.00
-Cylinders only ³	VKC3	
Concealed key control (CKC)		
-CKC cylinders with VKC keys	CKC2	\$8.00
-CKC cylinders only ³	CKC3	
More than 2 keys per lock	KY# (e.g., KY6)	See page 31 - Cut Keys Section

Notes:

1. CMK Construction master keying charge is in addition to master keying charge.
2. CMK Construction master keying is not available in interchangeable core, Access 3, Pyramid, or Security series.
3. VKC2, VKC3, CKC3 are not available in Access 3, Pyramid or Security series.

*Double cylinder keying: unless otherwise specified, both cylinders of 32 and 82 functions will be keyed alike. The inside cylinder of 72 function will be keyed to the master key(s) only, while the outside cylinder will include the change key.

If different keying is required, specify outside cylinder first, then inside cylinder.

For key bows other than 10 and 90, specify "KB" + bow number as Quick Code, e.g. KB12. No extra charge.

Strike Options*

To purchase strike separately, see catalog for part no.

Lip Length	ANSI Curved Lip Specify Quick Code	T-Strike Curved Lip Box Specify Quick Code	Add or Deduct
1-1/4"	Standard	NA	No Charge
2"	N/A	SC200	Add \$17.00 per lockset
2-1/8"	N/A	SC218	
2-1/4"	N/A	SC214	
2-1/2"	N/A	SC212	
2-3/4"	N/A	SC234	
3"	N/A	SC300	

Lip Length	ANSI Straight Lip For Door Pair** Quick Code	For Door Pair** Quick Code	Add or Deduct
1-13/16"	SA136	SP136	No Charge

Lip length	ANSI Straight Lip For Extended Lip Escutcheon Quick Code	For Extended Lip Escutcheon Quick Code	Add or Deduct
15/16"	Standard when Extended Lip Option is Specified	SX156	No Charge

*If door thickness is standard or has been specified and no special door or frame condition exist, then only the first two characters of the optional strike Quick code must be specified (e.g. "SC").

The correct lip length will be determined by our order entry system based on the standard or specified door thickness.

** Lip is measured from back of strike.

Miscellaneous Options

Description	Specify Quick Code	Add or Deduct
Split designs and split finishes	Outside Trim x Inside Trim	Higher set price prevails
Spanner head screws	M02	Add \$21.00 per lockset
Torx® head screws (on strike)	M04	Add \$26.00 per lockset
Lever to accept 6 or 7-pin SFIC (ESE only)	M08	Deduct \$20.00 per lockset
Extended lip escutcheon (for single door reverse bevel; 630 finish to match 626 only)	M11	Add \$52.00 per lockset
Knurling outside and inside	M20	Add \$148.00 per lockset
Knurling outside only	M21	Add \$75.00 per lockset
Knurling Inside only	M22	
Abrasive coat outside and inside	M23	
Abrasive coat inside only	M24	Add \$47.00 per lockset
Abrasive coat outside only	M25	
Lead lining escutcheon	M28	Add \$100.00 per escutcheon
Unstaked lever retainer	M33	No Charge

Standard Features
Case

Extruded Brass

Shackle

11/32" (8.7mm) diameter hardened steel (PL5000 Series), brass (PL5100 Series) or stainless steel (PL5200 Series)

Locking

Ball-bearing locking heel and toe

Cylinder

 RFC model: 6-pin Fixed Core (2300)
 IC model: 6-pin & Pyramid IC (8000 series)
 L4 keyway standard

Case Quantity

36

Case Weight

27 lbs

Ordering Example
Stock Order

Quantity	Series/Function
10	PL5000R

Access 3 Order

Quantity	Series/Function	Misc. Options
8	PL5070	ACP M44

Contract Order

Quantity	Keyset	Series/Function	Shackle Length	Misc. Options
10	AA1	PL5080	258	M45

Padlocks

Hardened Steel Shackle	Brass Shackle	Description	List Price
PL5000R	PL5100R	Rekeyable Fixed Core (RFC)	\$110.00
PL5070*	PL5170*	Interchangeable core (IC), less core	\$116.00
PL5080	PL5180	IC 6-pin	\$196.00
PL5090	PL5190	IC security	\$315.00
PL5030	PL5130	Pyramid High Security (IC)	\$287.00
PL5037	PL5137	Pyramid Security (IC)	\$256.00

Stainless Steel Shackle	Description	List Price
PL5200R	Rekeyable Fixed Core (RFC)	\$115.00
PL5270*	Interchangeable core (IC), less core	\$121.00
PL5280	IC 6-pin	\$201.00
PL5290	IC security	\$320.00
PL5230	Pyramid High Security (IC)	\$292.00
PL5237	Pyramid Security (IC)	\$261.00

Shackle Length Options with Padlocks

Description	Specify Quick Code	Add or Deduct
7/8"	(standard)	No Charge
2-5/8"	258	Add \$5.00 to padlock

* Access 3 is only available with Less Core.

Cylinder & Keying Options*

Description	Specify Quick Code	Add or Deduct
Access 3 IC Patented	ACP	Add \$80.00 per cylinder
Access 3 IC Security	ACS	Add \$132.00 per cylinder
Access 3 IC High Security, UL 437	ACHS	Add \$153.00 per cylinder
Keyed random (standard for Pyramid & IC security padlocks)	KR	No Charge
0-Bitted (not available for Pyramid & IC security padlocks)	(standard)	
Master Keyed RFC	specify keyset	Add \$16.00 per cylinder
Master Keyed IC security	specify keyset	
Master Keyed IC 6-pin & Pyramid IC	specify keyset	No Charge
Master Keyed to customer bittings or sample key	specify keyset	Add \$16.00 per cylinder
Construction Master Keyed (RFC & IC 6-pin padlocks only) ^{1,2}	CMK	Add \$16.00 per cylinder
Temporary construction core (IC 6-pin padlocks only) (Red)	CT6R	No Charge
Temporary Construction Core (IC 6-pin padlocks only) (Blue)	CT6B	No Charge
Temporary Construction Core (IC 6-pin padlocks only) (Green)	CT6G	No Charge
Visual key control (VKC)		
- No Stamping	VKC0	\$4.50
- Keys only	VKC1	No Charge
- Locks and Keys ³ (RFC & IC 6-pin padlocks only)	VKC2	\$8.00
- Locks only ³ (RFC & IC 6-pin padlocks only)	VKC3	
Concealed key control (CKC) (IC 6-pin & IC security padlocks only)		
- CKC cores with VKC keys ⁴	CKC2	\$8.00
- CKC cores only ^{3,4}	CKC3	
More than 2 keys per lock	KY# (e.g., KY6)	See page 31 - Cut Keys Section
Rekeybale FC (RFC) Less Cylinder	LC	Deduct \$21.00 per cylinder

Notes:

1. CMK Construction master keying charge is in addition to master keying charge.
 2. CMK is not available in Pyramid or Security series.
 3. VKC2, VKC3, CKC3 are not available in Access 3, Pyramid or Security series.
 4. CKC2, CKC3 is not available in PL5000, PL5100, PL5070 or PL5170 padlock.
- *For key bows other than 10 and 90, specify "KB" + bow number as Quick Code, e.g. KB12. No extra charge.

Miscellaneous Options

Description	Specify Quick Code	Add or Deduct
Chain and clevis attached	M44	Add \$4.00 to padlock
Custom die stamped case* (specify existing die number or lettering specifications for artwork)	M45**	Add \$5.50 per padlock

*To create new die stamp, contact factory. Provide artwork with request for quotation.
Die stamps remain the property of Corbin Russwin.

**Only available on PL5200 Series stainless steel shackle padlocks.

**ANSI/BHMA 156.5
Grade 2**

Standard Features
Handing
Non-handed

Door Thickness
1-3/8" - 2-1/4"

Backset
2-3/4" (standard)
2-3/8" available

Strike
2-3/4" x 1-1/8"

Cylinder
Brass 6-pin,
0-bitted, L4 keyway

Keys
Two nickel silver keys

Case Quantity
14

Case Weight
30 lbs

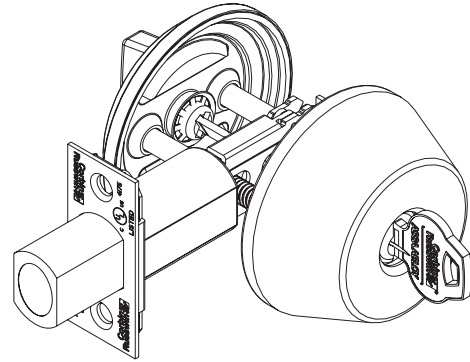

Ordering Example

Stock Order

Quantity	Series/Function	Finish
30	DL2213	626

Contract Order

Quantity	Keyset	Finish	Keyset	Optional Strike
30	DL2213	626	AA1	SS134

Function	Description	Finish: 613E, 626, BSP, WSP	Finish: 605, 606, 612, 613, 625
DL2213	Single Cylinder	\$116.00	\$123.00
DL2212	Double Cylinder	\$150.00	\$157.00
DL2217	Classroom	\$116.00	\$123.00
DL2211	Cylinder x Blank		
DL2260	Thumbturn x Blank	\$85.00	\$89.00

Cylinder & Keying Options*

Description	Specify Quick Code	Add or Deduct
Conventional 6-pin	(standard)	No Charge
Conventional 7-pin	7P	Add \$2.00 per cylinder
Less cylinder	LC	No Deduct
Interchangeable core (IC) 6-pin Pyramid High Security IC Pyramid Security Fixed Core	C6	Add \$80.00 per cylinder
IC 6-pin less core	CL6	No Charge
SFIC 6-pin with Less Core	CLS6	No Charge
IC 6-pin with temporary construction core	CT6	Add \$80.00 per cylinder
IC 7-pin	C7	Add \$82.00 per cylinder
IC 7-pin less core	CL7	No Charge
SFIC 7-pin with Less Core	CLS7	No Charge
IC 7-pin with temporary construction core	CT7	Add \$82.00 per cylinder
Security	HS	Add \$119.00 per cylinder
Security IC	CHS	Add \$199.00 per cylinder
Access 3 Patented	AP	No Charge
Access 3 Security	AS	Add \$61.00 per cylinder
Access 3 High Security, UL 437	AHS	Add \$86.00 per cylinder
Access 3 IC Patented	ACP	Add \$80.00 per cylinder
Access 3 IC Security	ACS	Add \$132.00 per cylinder
Access 3 IC High Security, UL 437	ACHS	Add \$153.00 per cylinder
Pyramid High Security Fixed Core	PHS	Add \$94.00 per cylinder
	PCHS	Add \$171.00 per cylinder
	PS	Add \$64.00 per cylinder
Pyramid Security IC	PCS	Add \$140.00 per cylinder
0-Bitted with two blank keys	(standard)	No Charge
Keyed Random	KR	
Construction Master Keyed (not available for interchangeable core, Access 3, Pyramid, or Security series.	CMK	Add \$16.00 per cylinder
Visual key control (VKC)		
- Keys only	VKC1	No Charge
- Cylinders and Keys (not for Access 3, Pyramid, HS or CHS)	VKC2	\$8.00
- Cylinders only (not for Access 3, Pyramid, HS or CHS)	VKC3	
Concealed key control (CKC)		
- CKC cylinders with VKC keys	CKC2	\$8.00
- CKC cylinders only	CKC3	
More than 2 keys per lock	KY# (e.g., KY6)	See page 31 - Cut Keys Section

Notes:

1. CMK Construction master keying charge is in addition to master keying charge.

*Both cylinders of double cylinder deadlocks are keyed alike, unless otherwise specified. If different keying is required, specify outside cylinder first, then inside cylinder.

For key bows other than 10 and 90, specify 'KB' + bow number as Quick Code, e.g. KB12.

Note: KB92 cannot be furnished with VKC or other markings.

Strike Options

To purchase strike separately, see catalog or parts manual for part no.

Lip Length	ANSI Straight Lip - Specify Quick Code	Add or Deduct
7/8"	SS078	No Charge
1-1/8"	SS118	
1-1/4"	SS114	
1-3/8"	SS138	
1-1/2"	SS112	
1-3/4"	SS134	Add \$17.00 per lockset
2"	SS200	
2-1/4"	SS214	
2-1/2"	SS212	
2-3/4"	SS234	
3"	SS300	

Door Thickness Options

Description	Specify Quick Code	Add or Deduct
1-3/8"	D138	No Charge
1-3/4"	(standard)	No Charge
2"	D200	No Charge
2-1/4"	D214	No Charge

Miscellaneous Options

1" (25mm) bolt front, square corners	M14	Add \$6.00 per dead lock
ANSI wrought strike box	M17	
Plastic box for standard strike	(standard)	
2-3/8" (60mm) backset bolt	B238	

Standard Features
Handing

Non-handed, except DL3017 function

Door Thickness

1-3/4" - 2-1/4"

Backset

2-3/4" (standard)

Strike

Wrought brass or bronze
2-3/4" x 1-1/8" with
wrought box

Cylinder

Brass 6-pin,
0-bitted, L4 keyway

Keys

Two nickel silver keys

Weight

2.5 lbs each



Ordering Example

Stock Order

Quantity	Series/Function	Finish
30	DL3013	626

Contract Order

Quantity	Keypad	Finish	Keypad	Optional Strike
30	DL3013	626	AA1	SD002

Function	Description	Finish: 605, 606, 612 613 613E, 618, 619, 625, 626, 722, BSP, WSP
DL3013	Single Cylinder	\$271.00
DL3012	Double Cylinder	\$364.00
DL3017	Classroom*	\$277.00
DL3011	Cylinder x Blank	\$271.00
DL3060	Thumbturn x Blank	

*Thumbturn will not project deadbolt. Specify hand.

Cylinder & Keying Options*

Description	Specify Quick Code	Add or Deduct
Conventional 6-pin	(standard)	No Charge
Conventional 7-pin	7P	Add \$2.00 per cylinder
Less cylinder	LC	Deduct \$93.00 per cylinder
Access 3 Patented	AP	No Charge
Access 3 Security	AS	Add \$61.00 per cylinder
Access 3 High Security, UL 437	AHS	Add \$86.00 per cylinder
Access 3 IC Patented	ACP	Add \$80.00 per cylinder
Access 3 IC Security	ACS	Add \$132.00 per cylinder
Access 3 IC High Security, UL 437	ACHS	Add \$153.00 per cylinder
Pyramid Security fixed core	PS	Add \$64.00 per cylinder
Pyramid Security IC	PCS	Add \$140.00 per cylinder
Pyramid High Security fixed core	PHS	Add \$96.00 per cylinder
Pyramid High Security IC	PCHS	Add \$171.00 per cylinder
Pyramid IC with Temporary Construction Core Security	CTP	Add \$80.00 per cylinder
Security IC	HS	Add \$121.00 per cylinder
Security IC	CHS	Add \$199.00 per cylinder
IC 6-pin	C6	Add \$80.00 per cylinder
IC 6-pin with temporary construction core	CT6R	Add \$80.00 per cylinder
UL IC 6-Pin Housing Less Core	CL6AH	
UL IC 6-Pin Housing with Disposable Core	CTAHD	
UL IC 6-Pin Housing with (Red/Blue/Green) Temporary Construction Core	CT6AH(R/B/G)	Add \$173.00 per cylinder
IC 6-pin less core	CL6	No Charge
SFIC 6-pin with Less Core	CLS6	
SFIC 7-pin less core	CLS7	
IC 7-pin	C7	Add \$82.00 per cylinder
IC 7-pin Less Core	CL7	No Charge
IC 7-pin with Temporary Construction Core	CT7 (R/B/G)	Add \$82.00 per cylinder
0-Bitted with 2 blank keys	(standard)	No Charge
Keyed random	KR	
Construction master keyed ^{1,2}	CMK	Add \$16.00 per cylinder
Visual key control (VKC)		
- Keys only	VKC1	No Charge
- Cylinders and Keys ³	VKC2	\$8.00
- Cylinders only ³	VKC3	
Concealed key control (CKC)		
- CKC cylinders with VKC keys	CKC2	\$8.00
- CKC cylinders only ³	CKC3	
More than 2 keys per lock	KY# (e.g., KY6)	See page 31 - Cut Keys Section

Notes:

1. CMK Construction master keying charge is in addition to master keying charge.
2. CMK is not available in interchangeable core, Access 3, Pyramid, or Security series.
3. VKC2, VKC3, CKC3 are not available in Access 3, Pyramid or Security series.
*Both cylinders of double cylinder deadlocks are keyed alike, unless otherwise specified. If different keying is required, specify outside cylinder first, then inside cylinder. For key bows other than 10 and 90, specify "KB" + bow number as Quick Code, e.g. KB12. No extra charge.
4. Refer to page 47 for example of CTP option pricing.

Strike Options*

To purchase strike separately, see catalog or parts manual for part no.

Lip Length	ANSI Straight Lip - Specify Quick Code	Add or Deduct
7/8"	SS078	No Charge
1-1/8"	SS118	
1-1/4"	SS114	
1-3/8"	SS138	
1-1/2"	SS112	
1-3/4"	SS134	Add \$17.00 per lockset
2"	SS200	
2-1/4"	SS214	
2-1/2"	SS212	
2-3/4"	SS234	
3"	SS300	

Strike Options (No lip)

	Specify Quick Code	Add or Deduct
2-3/4" x 1-1/8"	(standard)	No Charge
3-1/2" x 1-1/8"	SD001	

Door Thickness Options

Description	Specify Quick Code	Add or Deduct
1-3/8" (Not available in IC option)	D138	No Charge
1-3/4" - 2"	(standard)	
2-1/4"	D214	Add \$7.00 per dead lock

Miscellaneous Options

Description	Specify Quick Code	Add or Deduct
ANSI wrought box	M17	No Charge
Ergonomic Thumbturn	M34	Add \$14.00
Wrought box for standard strike	(standard)	No Charge
2-3/8" backset	B238	

Standard Features
Handing
Non-handed

Door Thickness
1-3/8" - 2-1/4"

Backset
2-3/4" (standard)
2-3/8" available

Strike
2-3/4" x 1-1/8"

Cylinder
Brass 6-pin,
0-bitted, L4 keyway

Keys
Two nickel silver keys

Case Quantity
Case Weight

ANSI/BHMA 156.5
14
Grade 1
30 lbs

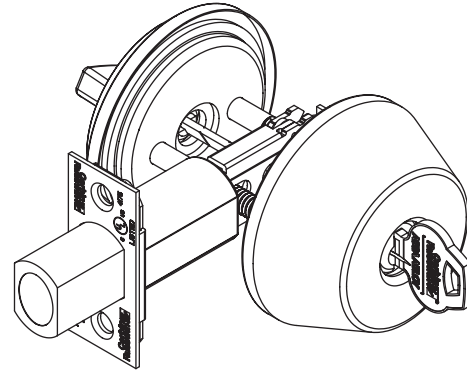

Ordering Example

Stock Order

Quantity	Series/Function	Finish
30	DL3213	626

Contract Order

Quantity	Keypad	Finish	Keypad	Optional Strike
30	DL3213	626	AA1	SS134

Function	Description	Finish: 613E, 626, BSP, WSP	Finish: 605, 606, 612, 613, 625
DL3213	Single Cylinder	\$212.00	\$219.00
DL3212	Double Cylinder	\$298.00	\$305.00
DL3217	Classroom	\$212.00	\$219.00
DL3211	Cylinder x Blank		
DL3260	Thumbturn x Blank	\$181.00	\$185.00

Cylinder & Keying Options*

Description	Specify Quick Code	Add or Deduct
Conventional 6-pin	(standard)	No Charge
Conventional 7-pin	7P	Add \$2.00 per cylinder
Less (1) cylinder	LC	Deduct \$93.00 per cylinder
IC 6-pin	C6	Add \$80.00 per cylinder
SFIC 6-pin with Less Core	CLS6	No Charge
IC 6-pin less core	CL6	No Charge
IC 6-pin with temporary construction core	CT6	Add \$80.00 per cylinder
IC 7-pin	C7	Add \$82.00 per cylinder
IC 7-pin with temporary construction core	CT7	Add \$82.00 per cylinder
SFIC 7-pin with Less Core	CLS7	No Charge
IC 7-pin less core	CL7	No Charge
Security		
Security IC		
Pyramid High Security Fixed Core	HS	Add \$121.00 per cylinder
Pyramid High Security IC		
Pyramid Security Fixed Core		
	CHS	Add \$199.00 per cylinder
Access 3 Patented	AP	No Charge
Access 3 Security	AS	Add \$61.00 per cylinder
Access 3 High Security, UL 437	AHS	Add \$86.00 per cylinder
Access 3 IC Patented	ACP	Add \$80.00 per cylinder
Access 3 IC Security	ACS	Add \$132.00 per cylinder
Access 3 IC High Security, UL 437	ACHS	Add \$153.00 per cylinder
	PHS	Add \$94.00 per cylinder
	PCHS	Add \$171.00 per cylinder
	PS	Add \$64.00 per cylinder
Pyramid Security IC	PCS	Add \$140.00 per cylinder
0-Bitted with 2 blank keys	(standard)	No Charge
Keyed Random	KR	
Construction Master Keyed (not available for interchangeable core, Access 3, Pyramid, or Security series.) ¹	CMK	Add \$16.00 per cylinder
Visual key control (VKC)		
- Keys only	VKC1	No Charge
- Cylinders and Keys (not for Access 3, Pyramid, CHS)	VKC2	\$8.00
- Cylinders only (not for Access 3, Pyramid, CHS)	VKC3	
Concealed key control (CKC)		
- CKC cylinders with VKC keys	CKC2	\$8.00
- CKC cylinders only	CKC3	
More than 2 keys per lock	KY# (e.g., KY6)	See page 31 - Cut Keys Section

Notes:

1. CMK Construction master keying charge is in addition to master keying charge.

*Both cylinders of double cylinder deadlocks are keyed alike, unless otherwise specified. If different keying is required, specify outside cylinder first, then inside cylinder.

For key bows other than 10 and 90, specify 'KB' + bow number as Quick Code, e.g. KB12.

NOTE: KB92 cannot be furnished with VKC or other markings.

Strike Options

To purchase strike separately, see catalog or parts manual for part no.

Lip Length	ANSI Straight Lip - Specify Quick Code	Add or Deduct
7/8"	SS078	No Charge
1-1/8"	SS118	
1-1/4"	SS114	
1-3/8"	SS138	
1-1/2"	SS112	
1-3/4"	SS134	Add \$17.00 per lockset
2"	SS200	
2-1/4"	SS214	
2-1/2"	SS212	
2-3/4"	SS234	
3"	SS300	

Door Thickness Options

Description	Specify Quick Code	Add or Deduct
1-3/8"	D138	No Charge
1-3/4"	(standard)	
2"	D200	
2-1/4"	D214	

Miscellaneous Options

Description	Specify Quick Code	Add or Deduct
1" (25mm) bolt front, square corners	M14	No Charge
ANSI wrought strike box	M17	
Plastic box for standard strike	(standard)	
2-3/8" (60mm) backset bolt	B238	

Standard Features

Handing
Non-handed

Door Thickness
1-3/4"

Backset
2-3/4"

Strike

Wrought brass or bronze
3-1/2" x 1-1/8"

Cylinder

6-pin, L4 keyway, 0-bitted

Keys

Two nickel silver keys

Weight

2.25 lbs each

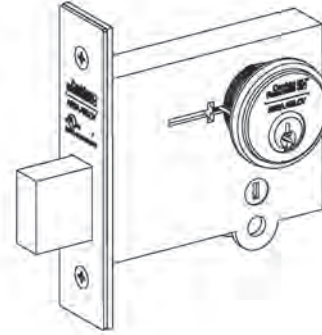

Ordering Example

Stock Order

Quantity	Series/Function	Finish
30	DL4113	626

Contract Order

Quantity	Keyset	Finish	Keyset	Optional Strike
30	DL4113	626	AA1	SS118

Function	Description	Finish: 613E, 626, BSP	Finish: 605, 606, 611, 612, 613, 618, 619, 625
DL4113	Single Cylinder	\$369.00	\$374.00
DL4112	Double Cylinder	\$405.00	\$410.00
DL4117	Classroom*	\$369.00	\$374.00
DL4111	Cylinder x Blank	\$310.00	\$315.00
DL4122	Double Cylinder x Thumbturn*	\$463.00	\$468.00
DL4160	Thumbturn x Blank	\$274.00	\$279.00

*Thumbturn will not project deadbolt.

Cylinder & Keying Options*

Description	Specify Quick Code	Add or Deduct
Conventional 6-pin	(standard)	No Charge
Conventional 7-pin	7P	Add \$2.00 per cylinder
Less cylinder	LC	Deduct \$93.00 per cylinder
Access 3 Patented	AP	No Charge
Access 3 Security	AS	Add \$61.00 per cylinder
Access 3 High Security, UL 437	AHS	Add \$86.00 per cylinder
Access 3 IC Patented	ACP	Add \$80.00 per cylinder
Access 3 IC Security	ACS	Add \$132.00 per cylinder
Access 3 IC High Security, UL 437	ACHS	Add \$153.00 per cylinder
Pyramid High Security fixed core	PS	Add \$96.00 per cylinder
Pyramid High Security IC	PCS	Add \$171.00 per cylinder
Pyramid High Security fixed core	PHS	Add \$96.00 per cylinder
Pyramid High Security IC	PCHS	Add \$171.00 per cylinder
Security	HS	Add \$121.00 per cylinder
Security IC	CHS	Add \$199.00 per cylinder
IC 6-pin	C6	Add \$80.00 per cylinder
IC 6-pin less core	CL6	No Charge
SFIC 6-pin with Less Core ²	CLS6	No Charge
IC 6-pin with SFIC disposable temporary core ²	CT6SD	No Charge
IC 6-pin with temporary construction core	CT6R	Add \$80.00 per cylinder
UL IC 6-Pin Housing Less Core	CL6AH	
UL IC 6-Pin Housing with Disposable Core	CTAHD	
UL IC 6-Pin Housing with (Red/Blue/ Green) Temporary Construction Core	CT6AH(R/B/G)	Add \$173.00 per cylinder
IC 7-pin	C7	Add \$82.00 per cylinder
IC 7-pin less core	CL7	Add \$2.00 per cylinder
IC 7-pin with temporary construction core	CT7	Add \$82.00 per cylinder
SFIC 7-pin with Less Core ²	CLS7	Add \$2.00 per cylinder
IC 7-pin with SFIC disposable temporary core ²	CT7SD	Add \$2.00 per cylinder
0-Bitted with 2 blank keys	(standard)	No Charge
Keyed random	KR	Add \$16.00 per cylinder
Construction master keyed ^{1, 2}	CMK	
Visual key control (VKC)		
- Keys only	VKC1	No Charge
- Cylinders and Keys ³	VKC2	\$8.00
- Cylinders only ³	VKC3	
Concealed key control (CKC)		
- CKC cylinders with VKC keys	CKC2	\$8.00
- CKC cylinders only ³	CKC3	
More than 2 keys per lock	KY# (e.g., KY6)	See page 31 - Cut Keys Section

Notes:

1. CMK Construction master keying charge is in addition to master keying charge.
 2. CMK is not available in interchangeable core, Access 3, Pyramid, or Security series.
 3. VKC2, VKC3, CKC3 are not available in Access 3, Pyramid or Security series.
- *Both cylinders of double cylinder deadlocks are keyed alike, unless otherwise specified. If different keying is required, specify outside cylinder first, then inside cylinder.
- For key bows other than 10 and 90, specify "KB" + bow number as Quick Code, e.g. KB12.
4. Refer to page 47 for example of CTP option pricing.

Strike Options

To purchase strike separately, see catalog for part no.

Lip length	ANSI Straight Lip Specify Quick Code	Add or Deduct
7/8"	SS078	Add \$17.00 per lockset
1-1/8"	SS118	
1-1/4"	SS114	
1-3/8"	SS138	
1-1/2"	SS112	
1-3/4"	SS134	
2"	SS200	
2-1/4"	SS214	
2-1/2"	SS212	
2-3/4"	SS234	
3"	SS300	

Door Thickness Options

Description	Specify Quick Code	Add or Deduct
1-3/4" - 2"	(standard)	No Charge
2-1/4"	D214	Add \$21.00 per dead lock
2-1/2"	D212	
2-3/4"	D234	
3"	D300	
3-1/4"	D314	Add \$33.00 per dead lock
3-1/2"	D312	
3-5/8"	D358	
3-3/4"	D334	
3-7/8"	D378	
4"	D400	

Miscellaneous Options

Description	Specify Quick Code	Add or Deduct
Spanner head screws	M02	Add \$21.00 per lockset
Torx head screws	M04	Add \$26.00 per lockset
ANSI wrought box	M17	No Charge
Lead wrapped case	M29	Add \$287.00 per lockset
Ergonomic Thumbturn (specify door thickness)	M34	Add \$15.00 per TT
Box for standard strike	M40	No Charge

Table of Contents

Multi-Point Exit Device Latching System

USA & Canada Prices Effective March 16, 2020

FE5400S Series Multi-Point Exit Device Latching System:

FE5400S Series Standard Features	206
FE5400S Series Ordering Examples, Pricing	207
FE5400S Series Heavy-Duty Trim Designs: A9 Armstrong, C9 Citation, D9 Dirke, E9 Essex	208
FE5400S Series Heavy-Duty Trim Designs: L9 Lustra, N9 Newport, R9 Regis, PR9 Princeton	209
FE5400S Series Heavy-Duty Trim Designs: G9, TH900 Pull/Thumbpiece, P9 Pull	210
FE5400S Series Heavy-Duty Trim Designs: FR9 Frascati, M9 Merlot, Z9 Zinfandel	211
FE5400S Series Heavy-Duty Trim Designs: Museo® Georgia, Pablo, Jackson, Salvador, Marc, Piet	212
FE5400S Series Electrically Controlled Trim Designs: A9 Armstrong, C9 Citation, D9 Dirke, E9 Essex	213
FE5400S Series Electrically Controlled Trim Designs: L9 Lustra, N9 Newport, R9 Regis, PR9 Princeton	214
FE5400S Series Electrically Controlled Trim Designs: FR9 Frascati, M9 Merlot, Z9 Zinfandel	215
FE5400S Series Electrically Controlled Trim Designs: Museo® Georgia, Pablo, Jackson, Salvador, Marc, Piet	216
FE5400S Series Electrified Options & Accessories	217
FE5400S Series Cylinder & Keying Options	218
FE5400S Series Door Height, Door Width, Door Thickness, Miscellaneous Options	219
FE5400S Series Removable Mullions & Options	220

FE6600 Series Multi-Point Latching System:

FE6600 Series Standard Features	221
FE6600 Series: ASA, CSA, LSA, NSA, PSA, RSA, NSM, NSN, NSR	222
FE6600 Series Designs: Georgia, Pablo, Jackson, Salvador, Marc, Josef	223
FE6600 Series Designs: Josef, Georges	224
FE6600 Series Designs: Piet	225
FE6600 Series Designs: Piet	226
FE6600 Series Vandal Resistant Trim: ASV, CSV, DSV, ESV, LSV, NSV, PSV, RSV	227
FE6600 Series Cylinder & Keying Options	228
FE6600 Series Cylinder & Keying Options (Con't), Strike Options	229
FE6600 Series Door Thickness, Options, Thumbturn Options, Strike Options	230

FE6700 Series Storm Shutter Multi-Point Latching System:

FE6700 Series Standard Features, Ordering Example	231
FE6700 Series Designs	232
FE6700 Series Optional Cylinder & Keying Options	233
FE6700 Series Optional Cylinder & Keying Options, Shutter Thickness, Shutter Height, Miscellaneous Options	234

MP9800 Series Multi-Point Vertical Rod Lock:

MP9800 Series Standard Features	235
MP9800 Series Levers: Armstrong, Citation, Dirke, Essex, Lustra, Newport, Regis, Princeton, Georgia, Pablo, Jackson, Salvador, Marc	236
MP9800 Series Levers: Armstrong, Citation, Dirke, Essex, Lustra, Newport, Regis, Princeton, Georgia, Pablo, Jackson, Salvador, Marc, Freewheeling Trim, Electromechanical	237
MP9800A Series Levers: Armstrong, Citation, Dirke, Essex, Lustra, Newport, Regis, Princeton, Georgia, Pablo, Jackson, Salvador, Marc	238
MP9800A Series Levers: Armstrong, Citation, Dirke, Essex, Lustra, Newport, Regis, Princeton, Georgia, Pablo, Jackson, Salvador, Marc, Freewheeling Trim, Electromechanical	239
MP9800 Series Piet Levers, Freewheeling Trim, Electromechanical	240
MP9800A Series Piet Levers, Freewheeling Trim, Electromechanical	241
MP9800 Series Josef, Georges Levers, Freewheeling Trim, Electromechanical	242
MP9800A Series Josef, Georges Levers, Freewheeling Trim, Electromechanical	243
MP9800 Series Cylinder Options, Keying Options	244
MP9800 Series Door Height Options, Door Width Options, Door Thickness, Motorized Electric Latch Retraction	245
MP9800 Series Miscellaneous Options	246

FE5400S

Multi-Point Exit Device Latching System



USA & Canada Prices Effective March 16, 2020

Standard Features

Handing

Device is non-handed
Lever trim is handed

Bar Length

Standard: 36" (914mm) bar fits 30" - 36"
(762mm-914mm) door

Door Height

7'0" (2134mm) standard

Door Thickness

1-3/4" (44mm) standard

Stile

Minimum width 4-1/2" (114mm).

Projection

3-1/4" (83mm) active, 2-3/4" (70mm) dogged.

Cylinders

Cylinder not included unless specified.

Warranty

Seven-year limited

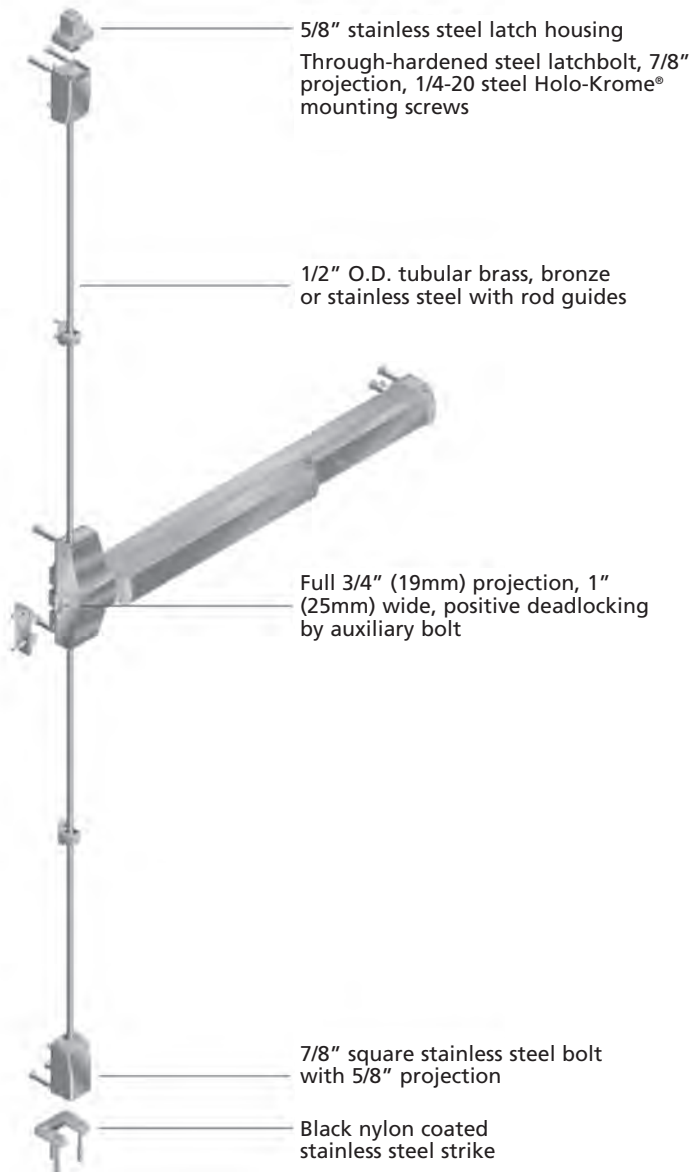

FE5400S

Multi-Point Exit Device Latching System



Ordering Examples

USA & Canada Prices Effective March 16, 2020

Exit Device Only

Quantity	Series/ Function	Finish	Hand	Misc. Options
65	FE5400S	626	RHR	M51

Trim Only

Quantity	Trim/ Function	Finish	Hand	Door Thickness
24	N955ET	625	RHR	D214

Exit Device with Trim

Quantity	Exit Device	Trim/ Function	Finish	Hand	Door Thickness	Door Width	Misc. Options
65	FE5400S	N955ET	605	LHR	D214	W048	M51

Contract/Detailed Order — Exit Device with Trim

Quantity	Keyset	Exit Device	Trim/ Function	Finish	Hand	Door Height	Door Width	Misc. Options	Cylinder Option
36	AA1	FE5400S	C955ET	626	LHR	HO800	W048	M52	7P

Pricing

36" Device Only

Includes device, strike(s) and screw pack. No cylinder or trim.

FE5400S Series			
Function	Description	Finish: 613E, 630', BSP, WSP	Finish: 605, 606, 611, 612, 613, 618, 619, 625, 626, 629, 722
FE5400S	Panic	\$3,810.00	\$3,890.00
FE5400SA	3 Hour Fire Rated	\$3,980.00	\$4,060.00

Caution: Be sure of your measurements. Exit devices are NOT returnable.

FE5400S

Multi-Point Exit Device Latching System



FE5400S Series Heavy-Duty Trim

USA & Canada Prices Effective March 16, 2020

Cylinder is not included.

Escutcheon Trim Design: A9 Armstrong

Lever: Cast **Escutcheon:** Forged

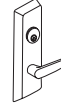

Function	Description	Finish: 605, 606, 611, 612, 613, 613E, 618, 619, 625, 626, 629 ² , 630 ¹ , 722, BSP, WSP
A910ET	Passage	\$733.00
A950ET	Dummy	
A955ET	Classroom ³	
A959ET	Storeroom	

Escutcheon Trim Design: C9 Citation

Lever: Cast **Escutcheon:** Forged

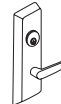

Function	Description	Finish: 605, 606, 611, 612, 613, 613E, 618, 619, 625, 626, 629 ² , 630 ¹ , 722, BSP, WSP
C910ET	Passage	\$733.00
C950ET	Dummy	
C955ET	Classroom ³	
C959ET	Storeroom	

Escutcheon Trim Design: D9 Dirke

Lever: Cast **Escutcheon:** Forged

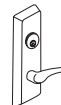

Function	Description	Finish: 605, 606, 611, 612, 613, 613E, 618, 619, 625, 626, 629 ² , 630 ¹ , 722, BSP, WSP
D910ET	Passage	\$733.00
D950ET	Dummy	
D955ET	Classroom ³	
D959ET	Storeroom	

Escutcheon Trim Design: E9 Essex

Lever: Cast **Escutcheon:** Forged



Function	Description	Finish: 605, 606, 611, 612, 613, 613E, 618, 619, 625, 626, 629 ² , 630 ¹ , 722, BSP, WSP
E910ET	Passage	\$733.00
E950ET	Dummy	
E955ET	Classroom ³	
E959ET	Storeroom	

Notes:

1. 619 finish provided to match 630 finish
2. 618 finish provided to match 629 finish.
3. Classroom function trim may be converted to storeroom function by a simple field adjustment. No additional parts required.

FE5400S

Multi-Point Exit Device Latching System

FE5400S Series Heavy-Duty Trim

USA & Canada Prices Effective March 16, 2020

Cylinder is not included.

Escutcheon Trim Design: L9 Lustra

Lever: Cast **Escutcheon:** Forged

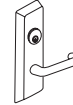

Function	Description	Finish: 605, 606, 611, 612, 613, 613E, 618, 619, 625, 626, 629 ² , 630 ¹ , 722, BSP, WSP
L910ET	Passage	\$733.00
L950ET	Dummy	
L955ET	Classroom ³	
L959ET	Storeroom	

Escutcheon Trim Design: N9 Newport

Lever: Cast **Escutcheon:** Forged

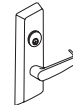

Function	Description	Finish: 605, 606, 611, 612, 613, 613E, 618, 619, 625, 626, 629 ² , 630 ¹ , 722, BSP, WSP
N910ET	Passage	\$733.00
N950ET	Dummy	
N955ET	Classroom ³	
N959ET	Storeroom	

Escutcheon Trim Design: R9 Regis

Lever: Cast **Escutcheon:** Forged

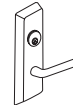

Function	Description	Finish: 605, 606, 611, 612, 613, 613E, 618, 619, 625, 626, 629 ² , 630 ¹ , 722, BSP, WSP
R910ET	Passage	\$733.00
R950ET	Dummy	
R955ET	Classroom ³	
R959ET	Storeroom	

Escutcheon Trim Design: PR9 Princeton

Lever: Cast **Escutcheon:** Forged

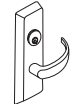

Function	Description	Finish: 605, 606, 611, 612, 613, 613E, 618, 619, 625, 626, 629 ² , 630 ¹ , 722, BSP, WSP
PR910ET	Passage	\$733.00
PR950ET	Dummy	
PR955ET	Classroom ³	
PR959ET	Storeroom	

Notes:

1. 619 finish provided to match 630 finish. - Escutcheons only
2. 618 finish provided to match 629 finish. - Escutcheons only
3. Classroom function trim may be converted to storeroom function by a simple field adjustment. No additional parts required.

FE5400S Multi-Point Exit Device Latching System

FE5400S Series Heavy-Duty Trim

USA & Canada Prices Effective March 16, 2020

Cylinder is not included.

Escutcheon Trim Design: G9

Lever: Cast

Escutcheon: Forged



Function	Description	Finish: 605, 606, 611, 612, 613, 613E, 618, 619, 625, 626, 629 ² , 630 ¹ , 722, BSP
G910ET	Passage	\$733.00
G950ET	Dummy	
G955ET	Classroom ³	
G959ET	Storeroom	

Notes:

1. 619 finish provided to match 630 finish. - Escutcheons only
2. 618 finish provided to match 629 finish. - Escutcheons only
3. Classroom function trim may be converted to storeroom function by a simple field adjustment. No additional parts required.

Escutcheon Trim Design: TH900 Pull/Thumbpiece

Grip: Extruded

Escutcheon: Forged



Function	Description	Finish: 605, 606, 611, 612, 613, 613E, 618, 619, 625, 626, 629 ² , 630 ¹ , 722, BSP
TH910ET	Passage	\$534.00
TH950ET	Dummy (No thumbpiece)	\$504.00
TH955ET	Classroom ³	\$534.00
TH959ET	Storeroom	\$504.00

Escutcheon Trim Design: P9 Pull



Pull: Extruded

Escutcheon: Forged

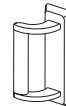

Function	Description	Finish: 605, 606, 611, 612, 613, 613E, 618, 619, 625, 626, 629 ² , 630 ¹ , 722, BSP
P950ET*	Dummy	\$461.00

* Specify Hand. Field Reversible.

FE5400S

Multi-Point Exit Device Latching System

FE5400S Series Heavy-Duty Trim

USA & Canada Prices Effective March 16, 2020

Cylinder is not included.

Escutcheon Trim Design: FR9 Frascati*



Escutcheon: Forged

* Handed Lever. Handing cannot be changed in the field.

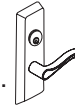

Function	Description	Finish: 605, 606, 611, 612, 613, 613E, 618, 619, 625, 626, 629 ² , 630 ¹ , 722, BSP
FR910ET	Passage	\$733.00
FR950ET	Dummy	
FR955ET	Classroom ³	
FR959ET	Storeroom	

Escutcheon Trim Design: M9 Merlot



Escutcheon: Forged

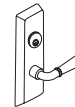

Function	Description	Finish: 605, 606, 611, 612, 613, 613E, 618, 619, 625, 626, 629 ² , 630 ¹ , 722, BSP
M910ET	Passage	\$733.00
M950ET	Dummy	
M955ET	Classroom ³	
M959ET	Storeroom	

Escutcheon Trim Design: Z9 Zinfandel*



Escutcheon: Forged

* Handed Lever. Handing cannot be changed in the field.



Function	Description	Finish: 605, 606, 611, 612, 613, 613E, 618, 619, 625, 626, 629 ² , 630 ¹ , 722, BSP
Z910ET	Passage	\$733.00
Z950ET	Dummy	
Z955ET	Classroom ³	
Z959ET	Storeroom	

Notes:

3. Classroom function trim may be converted to storeroom function by a simple field adjustment. No additional parts required.

FE5400S Multi-Point Exit Device Latching System

FE5400S Series Heavy-Duty Trim

USA & Canada Prices Effective March 16, 2020

Cylinder is not included.

Escutcheon Trim Design: Muséo®

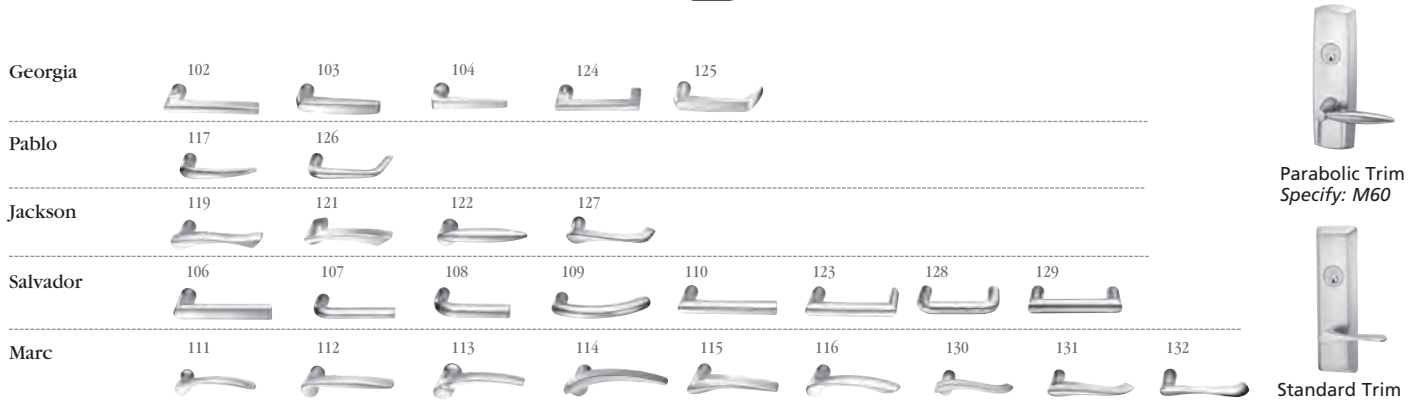

Function	Description	Finish: 605, 606, 611, 612, 613, 613E, 618, 619, 625, 626, 629 ² , 630 ¹ , 722, BSP
910ET	Passage	\$733.00
950ET	Dummy	
955ET	Classroom	
959ET	Storeroom	

*629 and *630 finish options are Not available for all Muséo levers. Please refer to page 20 for availability.

Escutcheon Trim Design: Muséo®

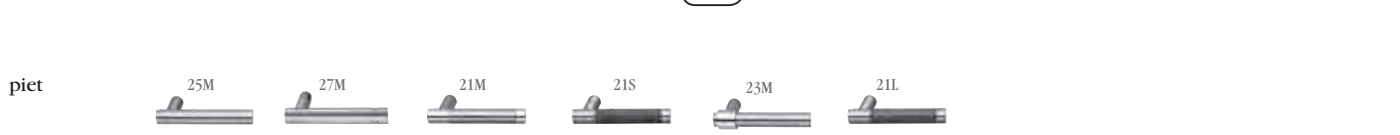

Function	Description	Finish: 613E, 629, 630, BSP, WSP
910ET	Passage	\$757.00
950ET	Dummy	
955ET	Classroom	
959ET	Storeroom	

FE5400S

Multi-Point Exit Device Latching System

FE5400S Series Electrically Controlled Trim

USA & Canada Prices Effective March 16, 2020

Cylinder is not included.

Escutcheon Trim Design: A9 Armstrong



Lever: Cast **Escutcheon:** Forged

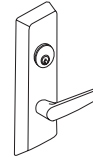

Function	Description	Finish: 605, 606, 611, 612, 613, 613E, 618, 619, 625, 626, 629 ² , 630 ¹ , 722, BSP, WSP
A9903ET*	Fail Safe	\$1,121.00
A9905ET*	Fail Secure	

Escutcheon Trim Design: C9 Citation



Lever: Cast **Escutcheon:** Forged

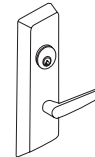

Function	Description	Finish: 605, 606, 611, 612, 613, 613E, 618, 619, 625, 626, 629 ² , 630 ¹ , 722, BSP, WSP
C9903ET*	Fail Safe	\$1,121.00
C9905ET*	Fail Secure	

Escutcheon Trim Design: D9 Dirke*



Lever: Cast **Escutcheon:** Forged

* Handed Lever. Handing cannot be changed in the field.

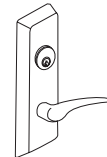

Function	Description	Finish: 605, 606, 611, 612, 613, 613E, 618, 619, 625, 626, 629 ² , 630 ¹ , 722, BSP, WSP
D9903ET*	Fail Safe	\$1,121.00
D9905ET*	Fail Secure	

Escutcheon Trim Design: E9 Essex



Lever: Cast **Escutcheon:** Forged

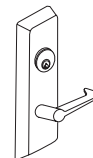

Function	Description	Finish: 605, 606, 611, 612, 613, 613E, 618, 619, 625, 626, 629 ² , 630 ¹ , 722, BSP, WSP
E9903ET*	Fail Safe	\$1,121.00
E9905ET*	Fail Secure	

Notes:

- 619 finish provided to match 630 finish. - Escutcheons only
- 618 finish provided to match 629 finish. - Escutcheons only



***ElectroLynx®**

As part of their promise to provide innovative, fast and effective high security solutions to their customers, certain ASSA ABLOY Group brands offer *ElectroLynx®*, a universal quick-connect system that simplifies the electrification of the door opening.

FE5400S

Multi-Point Exit Device Latching System

FE5400S Series Electrically Controlled Trim

USA & Canada Prices Effective March 16, 2020

Cylinder is not included.

Escutcheon Trim Design: L9 Lustra

Lever: Cast **Escutcheon:** Forged

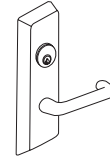

Function	Description	Finish: 605, 606, 611, 612, 613, 613E, 618, 619, 625, 626, 629 ² , 630 ¹ , 722, BSP, WSP
L9903ET*	Fail Safe	\$1,121.00
L9905ET*	Fail Secure	

Escutcheon Trim Design: N9 Newport

Lever: Cast **Escutcheon:** Forged

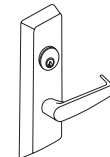

Function	Description	Finish: 605, 606, 611, 612, 613, 613E, 618, 619, 625, 626, 629 ² , 630 ¹ , 722, BSP, WSP
N9903ET*	Fail Safe	\$1,121.00
N9905ET*	Fail Secure	

Escutcheon Trim Design: R9 Regis

Lever: Cast **Escutcheon:** Forged

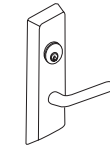

Function	Description	Finish: 605, 606, 611, 612, 613, 613E, 618, 619, 625, 626, 629 ² , 630 ¹ , 722, BSP, WSP
R9903ET*	Fail Safe	\$1,121.00
R9905ET*	Fail Secure	

Escutcheon Trim Design: PR9 Princeton

Lever: Cast **Escutcheon:** Forged

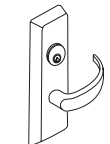

Function	Description	Finish: 605, 606, 611, 612, 613, 613E, 618, 619, 625, 626, 629 ² , 630 ¹ , 722, BSP, WSP
PR9903ET*	Fail Safe	\$1,121.00
PR9905ET*	Fail Secure	

Notes:

- 619 finish provided to match 630 finish. - Escutcheons only
- 618 finish provided to match 629 finish. - Escutcheons only



***ElectroLynx®**

As part of their promise to provide innovative, fast and effective high security solutions to their customers, certain ASSA ABLOY Group brands offer *ElectroLynx*®, a universal quick-connect system that simplifies the electrification of the door opening.

FE5400S Multi-Point Exit Device Latching System

FE5400S Series Electrically Controlled Trim

USA & Canada Prices Effective March 16, 2020

Cylinder is not included.

Escutcheon Trim Design: FR9 Frascati

Lever: Cast **Escutcheon:** Forged

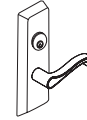

Function	Description	Finish: 605, 606, 611, 612, 613, 613E, 618, 619, 625, 626, 629 ² , 630 ¹ , 722, BSP, WSP
FR9903ET*	Fail Safe	\$1,121.00
FR9905ET*	Fail Secure	

Escutcheon Trim Design: M9 Merlot

Lever: Cast **Escutcheon:** Forged

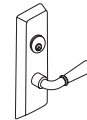

Function	Description	Finish: 605, 606, 611, 612, 613, 613E, 618, 619, 625, 626, 629 ² , 630 ¹ , 722, BSP, WSP
M9903ET*	Fail Safe	\$1,121.00
M9905ET*	Fail Secure	

Escutcheon Trim Design: Z9 Zinfandel

Lever: Cast **Escutcheon:** Forged

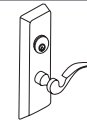

Function	Description	Finish: 605, 606, 611, 612, 613, 613E, 618, 619, 625, 626, 629 ² , 630 ¹ , 722, BSP, WSP
Z9903ET*	Fail Safe	\$1,121.00
Z9905ET*	Fail Secure	



*ElectroLynx®

As part of their promise to provide innovative, fast and effective high security solutions to their customers, certain ASSA ABLOY Group brands offer *ElectroLynx*®, a universal quick-connect system that simplifies the electrification of the door opening.

FE5400S Multi-Point Exit Device Latching System

FE5400S Series Electrically Controlled Trim

USA & Canada Prices Effective March 16, 2020

Cylinder is not included.

Escutcheon Trim Design: Muséo®

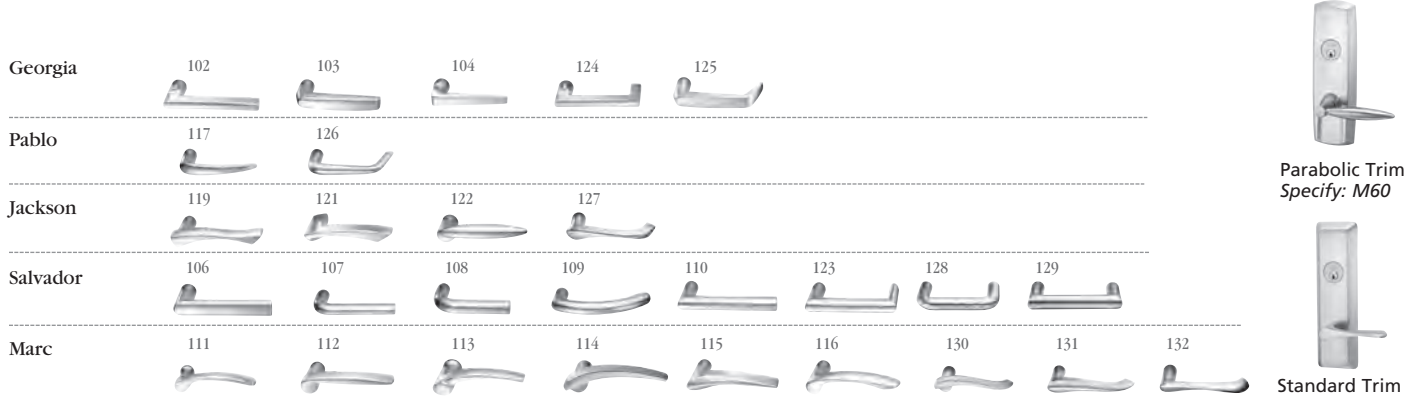

Function	Description	Finish: 605, 606, 611, 612, 613, 613E, 618, 619, 625, 626, 629 ² , 630 ¹ , 722, BSP, WSP
9903ET**	Fail Safe	\$1,121.00
9905ET**	Fail Secure	

*629 and *630 finish options are Not available for all Muséo levers. Please refer to page 20 for availability.

Escutcheon Trim Design: Muséo®

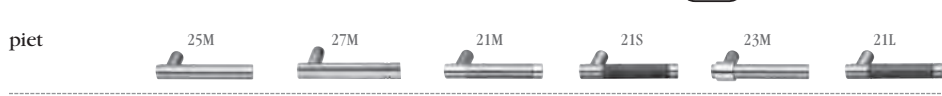

Function	Description	Finish: 629, 630
9903ET**	Fail Safe	\$1,164.00
9905ET**	Fail Secure	



**ElectroLynx®

As part of their promise to provide innovative, fast and effective high security solutions to their customers, certain ASSA ABLOY Group brands offer *ElectroLynx*®, a universal quick-connect system that simplifies the electrification of the door opening.

FE5400S Electrically Controlled Trim



Electrified Options

USA & Canada Prices Effective March 16, 2020

Description	Specify Quick Code	Add or Deduct
Touchbar Monitoring or Signaling/Request to Exit (REX)	M92*	Add \$213.00
Outside Trim Monitoring or Signaling	M93*	Add \$213.00
SPDT Lock and Unlock security monitor switch (Electric Trim Only)	M98*	Add \$205.00
Trim gasket for exterior applications (Electric Trim Only)	M99	Add \$23.00

Electrified Accessories

Part Number	Description	Specify	Price
709F649	Power Supply 1 Amp @ 12VDC Output	BPS-12-1	\$355.00
709F659	Power Supply 3 Amp @ 12VDC Output	BPS-12-3	\$722.00
709F609	Power Supply 2 Amp @ 24VDC Output	BPS-24-1	\$355.00
709F619	Power Supply 2 Amp @ 24VDC Output	BPS-24-2	\$722.00
709F629	Power Supply 4 Amp @ 24VDC Output	BPS-24-4	\$1,220.00
704F288	Concealed transfer (for over 120-degree swing door)	EPTL	\$140.00
709F689	(1) SPDT Maintained Switch (Includes LED)	MKA	\$124.00
709F709	(1) SPDT Momentary Switch (Includes LED)	MK	\$214.00
709F759	(1) SPDT Maintained (Alternating Action) Switch	PB3EA	\$125.00
709F729	DPDT Momentary Key Switch	2' MK2	\$246.00
704F719	Narrow Stile Momentary Key Switch	MKN	\$214.00
709F789	Sonalert 90db @ 2 ft. 12-24VDC Mounted on one gang stainless steel plate.	PZ1	\$106.00



*ElectroLynx®

As part of their promise to provide innovative, fast and effective high security solutions to their customers, certain ASSA ABLOY Group brands offer *ElectroLynx*®, a universal quick-connect system that simplifies the electrification of the door opening.

FE5400S Electrically Controlled Trim Multi-Point Exit Device Latching System



Cylinder Options*

USA & Canada Prices Effective March 16, 2020

Description	Specify Quick Code	Add or Deduct
Conventional 6-pin	6P**	Add \$93.00 per cylinder
Conventional 7-pin	7P	Add \$95.00 per cylinder
Access 3 Patented	AP	No Charge
Access 3 Security	AS	Add \$61.00 per cylinder
Access 3 High Security, UL 437	AHS	Add \$86.00 per cylinder
Access 3 IC Patented	ACP	Add \$80.00 per cylinder
Access 3 IC Security	ACS	Add \$132.00 per cylinder
Access 3 IC High Security, UL 437	ACHS	Add \$153.00 per cylinder
Pyramid Security fixed core	PS	Add \$157.00 per cylinder
Pyramid Security IC	PCS	Add \$233.00 per cylinder
Pyramid High Security fixed core	PHS	Add \$189.00 per cylinder
Pyramid High Security IC	PCHS	Add \$264.00 per cylinder
Pyramid IC with temporary construction core	CTP	Add \$173.00 per cylinder
Pyramid IC with temporary disposable core	CTPD	Add \$93.00 per cylinder
Pyramid IC less core	CLP	Add \$93.00 per cylinder
Security	HS	Add \$214.00 per cylinder
Security IC	CHS	Add \$292.00 per cylinder
IC 6-pin	C6	Add \$173.00 per cylinder
IC 6-pin with temporary construction core (Red)	CT6R	Add \$173.00 per cylinder
IC 6-pin with temporary construction core (Blue)	CT6B	Add \$173.00 per cylinder
IC 6-pin with temporary construction core (Green)	CT6G	Add \$173.00 per cylinder
IC 6-pin with temporary disposable core	CT6D	Add \$93.00 per cylinder
IC 6-pin less core	CL6	Add \$93.00 per cylinder
SFIC 6-pin with Less Core	CLS6	Add \$93.00 per cylinder
IC 6-pin with SFIC disposable temporary core	CT6SD	Add \$93.00 per cylinder
IC 7-pin	C7	Add \$177.00 per cylinder
IC 7-pin with temporary construction core (Red)	CT7R	Add \$177.00 per cylinder
IC 7-pin with temporary construction core (Blue)	CT7B	Add \$177.00 per cylinder
IC 7-pin with temporary construction core (Green)	CT7G	Add \$177.00 per cylinder
IC 7-pin with temporary disposable core	CT7D	Add \$95.00 per cylinder
IC 7-pin less core	CL7	Add \$95.00 per cylinder
SFIC 7-pin with Less Core	CLS7	Add \$95.00 per cylinder
IC 7-pin with SFIC disposable temporary core	CT7SD	Add \$95.00 per cylinder

*Optional dogging cylinder will be furnished with the same mechanism and keyed alike with the trim cylinder, unless otherwise specified. If different keying or cylinder type is required, specify outside (trim) first, then inside (dogging) cylinder.

**6P cylinder option is supplied in 6-pin, L4 keyway, 0-bitted with two nickel silver keys.

Keying Accessories*

Description	Specify Quick Code	Add or Deduct
0-Bitted with 2 blank keys	(standard)	No Charge
Keyed random	KR	No Charge
Master keyed (all cylinders except 8000, 8020, 8027 IC)	specify keyset	Add \$16.00 per cylinder
Master keyed Pyramid	specify keyset	Add \$16.00 per cylinder
Master keyed Security (including IC cylinder and core)	specify keyset	Add \$16.00 per cylinder
Master keyed (8000, 8020, 8027 IC core)	specify keyset	No Charge
Master keyed to customer bittings or sample key	specify keyset	Add \$16.00 per cylinder
Construction master keyed ^{1,2}	CMK	Add \$16.00 per cylinder
Visual key control (VKC)		
- No Stamping	VKC0	\$4.50
- Keys only	VKC1	No Charge
- Cylinders and Keys ³	VKC2	\$8.00
- Cylinders only ³	VKC3	\$8.00
Concealed key control (CKC)		
- CKC cylinders with VKC keys	CKC2	\$8.00
- CKC cylinders only ³	CKC3	\$8.00
More than 2 keys per lock	KY# (e.g., KY6)	See page 31 - Cut Keys Section

*For key bows other than 10 and 90, specify "KB" + bow number as Quick Code, e.g. KB12.

Notes:

1. CMK Construction master keying charge is in addition to master keying charge.
2. CMK Construction master keying is not available in interchangeable core, Access 3, Pyramid, or Security series.
3. VKC2, VKC3, CKC3 are not available in Pyramid or Security series.

FE5400S Electrically Controlled Trim Multi-Point Exit Device Latching System



Door Height Options

USA & Canada Prices Effective March 16, 2020

Door Height	Specify Quick Code	Add or Deduct
7'0"	(standard)	No Charge
7'2"	H0702	No Charge
7'6"	H0706	No Charge
8'0"	H0800	No Charge

Door Width Options

Door Width	Specify Quick Code	Add or Deduct
32"	W032	No Charge
36"	(standard)	No Charge
42"	W042	No Charge
48"	W048	Add \$37.00 per device

Door Thickness Options

Door Thickness	Specify Quick Code	Add or Deduct
1-3/4"	(standard)	No Charge
2"	D200	No Charge
2-1/4"	D214	No Charge

Miscellaneous Options

Description	Specify	Add or Deduct
Knurling outside and inside (Embossed Touchbar - device side)	M20	Add \$153.00 per device
Knurling outside only (trim side)	M21	Add \$72.00 per device
Knurling inside only (Embossed Touchbar - device side)	M22	Add \$81.00 per device
Abrasive coat outside and inside (trim and device)	M23	Add \$97.00 per device
Abrasive coat inside only (device side)	M24	Add \$51.00 per device
Abrasive coat outside only (trim side)	M25	Add \$46.00 per device
PathLite™ Photoluminescent Touchbar cover	M49	Add \$364.00 per device
Less dogging	M51	No Charge
Cylinder dogging (less cylinder)	M52	Add \$82.00 per device
Mullion stabilizer	M57	Add \$63.00 per mullion
Parabolic Design Exit Trim	M60	Add \$82.00 per device
MicroShield® Antimicrobial finish coating	626C	Add \$69.00 (Exit Devices & Trims (ordered separately).
MicroShield® Antimicrobial finish coating	630C	Add \$86.00 (Exit Devices & Outside Trims (ordered together).

FE5400S

Multi-Point Exit Device Latching System



Removable Mullions

USA & Canada Prices Effective March 16, 2020

Door Height	Description	Specify	Price
Up to 7'0"	Steel Mullion - 3 Hour Fire Rated, Windstorm Certified	CRFE707A ⁴	\$1,257.00
Up to 8'0"	Steel Mullion - 3 Hour Fire Rated, Windstorm Certified	CRFE708A ⁴	\$1,267.00

Note:

- For use with UL listed door assemblies that comply to FEMA 361 and ICC 500.
For the latest listings on compliant door assemblies visit our website at corbinrusswin.com

Options

Description	Specify Quick Code	Add or Deduct
Door frame filler block for double rabbeted frames	M95	Add \$42.00 per mullion
Door frame angle bracket for aluminum frames	M96	Add \$42.00 per mullion

FE6600 Series FE66600 Series Multi-Point Locks

USA & Canada Prices Effective
March 16, 2020

Door	1-3/4" thick door only; fully integrated – FE66600 is part of a complete ASSA ABLOY windstorm solution utilizing CECO StormPro® 361 and CURRIES StormPro® 361 doors and frames and MCKINNEY® StormPro® hinges
Mounting	Supplied fasteners are for metal doors with throughbolts for trim
Hand	Handed; specify RHR, LHR, RH or LH
Lockbody	Unique mortise lockbody assembly used specifically for FEMA applications
Top Bolt	Adjustable stainless steel 3/4" square bolt with 11/16" engagement; 5/16" steel reinforcement plate
Bottom Bolt	Adjustable stainless steel 3/4" square bolt with 5/8" engagement; 1/4" steel reinforcement plate
Center Bolts	Latchbolt is stainless steel with 3/4" projection. One piece, anti-friction reversible catch. Deadbolt is one piece hardened stainless steel with 1" projection
Lock Front	1/8" steel mortise front reinforced with 13/64" thick lock edge stiffener Center Bolt Strike 1/4" thick stainless steel
Backset	2-3/4" standard
Door Thickness	1-3/4" standard
Door Height	7'0" - 8'0"
Maximum Opening	Single door 4'0" x 8'0" and double doors 8'0" x 8'0"
UL Fire Listed	UL 3-hour fire rating
Trim	Multiple sectional and escutcheon mortise trim with Standard or Muséo levers
Functions	- Classroom - Storeroom - Dormitory/Exit - Privacy
Cylinder	Multiple mortise cylinders

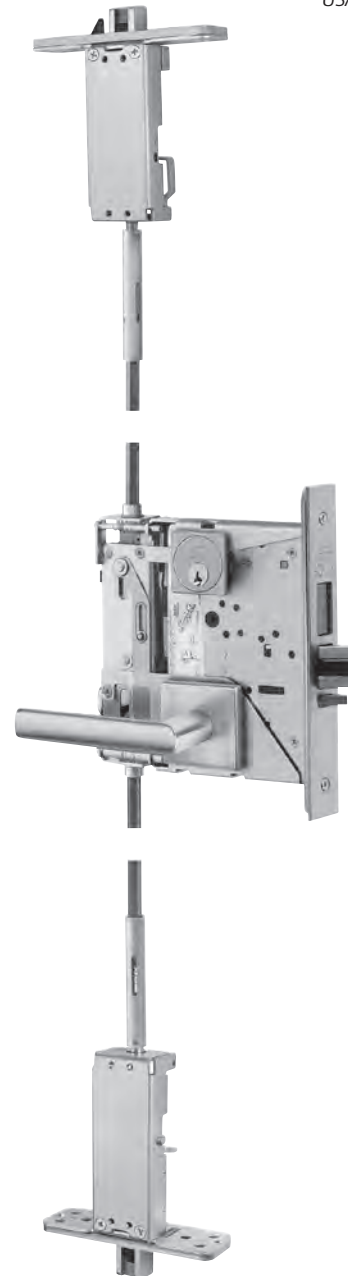

How to Order

Ordering Example

Quantity	Series/ Function	Trim	Finish	Hand
100	FE6618	ASM	626	RHR

Note: This product is part of a complete tornado assembly and must be used with a Ceco or Curries StormPro door. Concealed vertical rods, top & bottom latches, and the lockbody cassette will be factory installed. All other hardware components are shipped directly to the customer and must be installed by a factory trained installer. Invoices for the door will be separate from the hardware invoice. The hardware invoice will include the concealed vertical assembly and the trim components.

FE6600 Series Multi-Point Locks



USA & Canada Prices Effective March 16, 2020

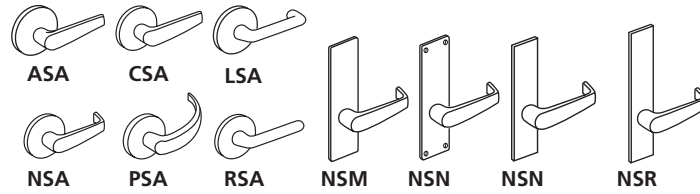

Lever: Cast
Rose: Wrought

Lever: Cast
Escutcheon: Wrought

Lever: Cast
Escutcheon: Solid Stainless Steel
or Forged Brass

Levers: AS, CS, ES, LS, NS, PS, RS
Roses: A, G

Levers: AS, CS, ES, LS, NS, PS, RS
Escutcheons: M, N, LW1

Levers: AS, CS, ES, LS, NS, PS, RS
Escutcheons: RE1/RE2, RE3/RE4

Description/Function	Levers: AS, CS, ES, LS, NS, PS, RS Roses: A, G		Levers: AS, CS, ES, LS, NS, PS, RS Escutcheons: M, N, LW1		Levers: AS, CS, ES, LS, NS, PS, RS Escutcheons: RE1/RE2, RE3/RE4		
	613E, 626, BSP, WSP	605, 606, 611, 612, 613, 618, 619, 625, 629, 630, 722	613E, 626, BSP, WSP	605, 606, 611, 612, 613, 618, 619, 625, 629, 630, 722	613E, 626, BSP, WSP	605, 606, 611, 612, 613, 618, 619, 625, 629, 630, 722	
FE6618 - Classroom							
FE6620 - Privacy							
FE6622 - Store Door							
FE6624 - Storeroom Door							
FE6630 - Privacy Bath/Bedroom							
FE6662 - Classroom Security Intruder Deadbolt	\$3,746.00	\$3,770.00	\$3,766.00	\$3,790.00	\$3,820.00	\$3,844.00	
FE6665 - Dormitory							
FE6672 - Classroom Security Intruder Deadbolt							
FE6673 - Classroom Security Intruder Deadbolt							
FE6675 - Security Deadbolt							
FE6680 - Passage Lever x Blank Plate							
Electrified Mortise Locks							
FE66609 x NAC SAF/SEC	Non-Key Override	\$3,946.00	\$3,970.00	\$3,966.00	\$3,990.00	\$4,020.00	\$4,044.00
FE66608 x NAC SAF/SEC	Key Override	\$4,086.00	\$4,110.00	\$4,106.00	\$4,130.00	\$4,160.00	\$4,184.00

FE6600 Series Multi-Point Locks

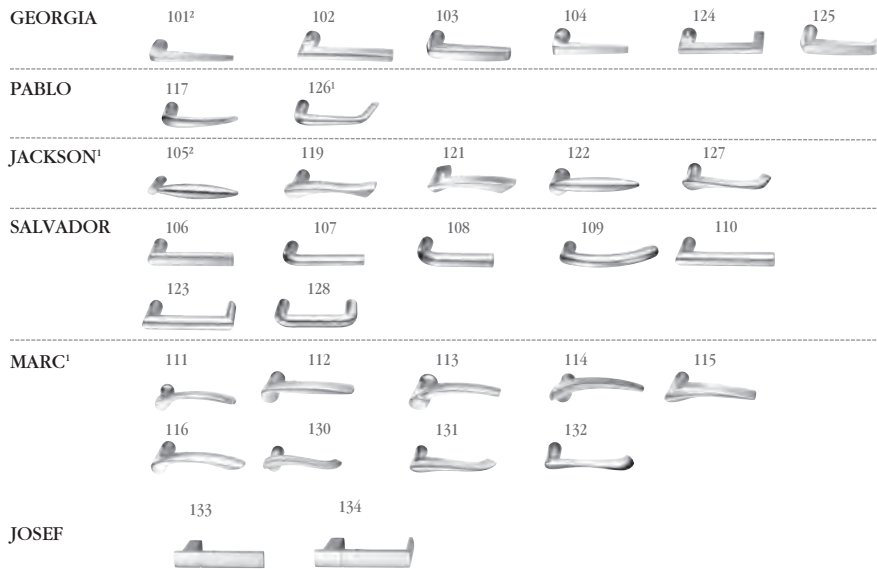

ROSES

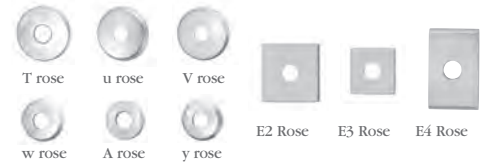

ESCUTCHEONS



THUMBTURNS



1. Handed: specify hand when ordering
2. Contact factory for current lead time
3. Specify thumbturn as quick code. Thumbturn backplate will match shape of rose chosen (i.e. round or square). Not available with escutcheons.

*629 and *630 finish options are Not available for all Muséo levers. Please refer to page 20 for availability.

613E	Dark Oxidized Satin Bronze
	- Equivalent
626	Satin Chromium Plated
BSP	Black Suede Powder Coat
WSP	White Suede Powder Coat

605	Bright Brass, Clear Coated	618	Bright Nickel Plated
606	Satin Brass, Clear Coated	619	Satin Nickel Plated
611	Bright Bronze, Clear Coated	625	Bright Chromium Plated
612	Satin Bronze, Clear Coated	629*	Bright Stainless Steel
613	Dark Oxidized Satin Bronze, Oil Rubbed	630*	Satin Stainless Steel
613L	Dark Oxidized Satin Bronze, Clear Coated	722	Black Oxidized Bronze, Oil Rubbed

Function

Lever with Escutcheons: L, CE, RE1			
FE6618 - Classroom			
FE6620 - Privacy			
FE6622 - Store Door			
FE6624 - Storeroom Door			
FE6630 - Privacy Bath/Bedroom			
FE6662 - Classroom Security Intruder Deadbolt	\$3,786.00		\$3,810.00
FE6665 - Dormitory			
FE6672 - Classroom Security Intruder Deadbolt			
FE6673 - Classroom Security Intruder Deadbolt			
FE6675 - Security Deadbolt			
FE6680 - Passage Lever x Blank Plate			
Electrified Mortise Locks			
FE66609 x NAC SAF/SEC	Non-Key Override	\$3,986.00	\$4,010.00
FE66608 x NAC SAF/SEC	Key Override	\$4,126.00	\$4,150.00
Lever with Roses: A, T, U, V, W, Y, E2, E3, E4			
FE6618 - Classroom			
FE6620 - Privacy			
FE6622 - Store Door			
FE6624 - Storeroom Door			
FE6630 - Privacy Bath/Bedroom			
FE6662 - Classroom Security Intruder Deadbolt	\$3,746.00		\$3,770.00
FE6665 - Dormitory			
FE6672 - Classroom Security Intruder Deadbolt			
FE6673 - Classroom Security Intruder Deadbolt			
FE6675 - Security Deadbolt			
FE6680 - Passage Lever x Blank Plate			
Electrified Mortise Locks			
FE66609 x NAC SAF/SEC	Non-Key Override	\$3,946.00	\$3,970.00
FE66608 x NAC SAF/SEC	Key Override	\$4,086.00	\$4,110.00

FE6600 Series Multi-Point Locks

USA & Canada Prices Effective March 16, 2020

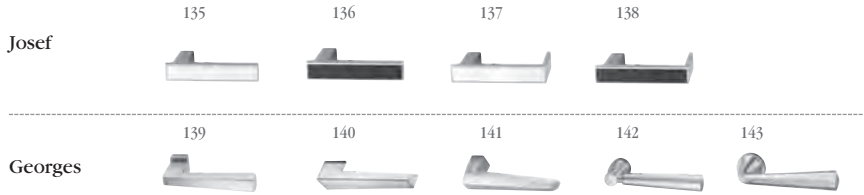

ROSES

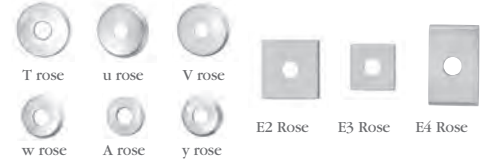

ESCUTCHEONS



THUMBTURNS*



1. Handed: specify hand when ordering
2. Contact factory for current lead time
3. Specify thumbturn as quick code. Thumbturn backplate will match shape of rose chosen (i.e. round or square). Not available with escutcheons.

613E	Dark Oxidized Satin Bronze - Equivalent
626	Satin Chromium Plated
BSP	Black Suede Powder Coat
WSP	White Suede Powder Coat

605	Bright Brass, Clear Coated
606	Satin Brass, Clear Coated
611	Bright Bronze, Clear Coated
612	Satin Bronze, Clear Coated
613	Dark Oxidized Satin Bronze, Oil Rubbed
613L	Dark Oxidized Satin Bronze, Clear Coated

618	Bright Nickel Plated
619	Satin Nickel Plated
625	Bright Chromium Plated
629	Bright Stainless Steel
630	Satin Stainless Steel
722	Black Oxidized Bronze, Oil Rubbed

Function

Lever with Escutcheons: L, CE, RE1			
FE6618 - Classroom			
FE6620 - Privacy			
FE6622 - Store Door			
FE6624 - Storeroom Door			
FE6630 - Privacy Bath/Bedroom			
FE6662 - Classroom Security Intruder Deadbolt		\$3,872.00	\$3,896.00
FE6665 - Dormitory			
FE6672 - Classroom Security Intruder Deadbolt			
FE6673 - Classroom Security Intruder Deadbolt			
FE6675 - Security Deadbolt			
FE6680 - Passage Lever x Blank Plate			
Electrified Mortise Locks			
FE66609 x NAC SAF/SEC	Non-Key Override	\$4,072.00	\$4,096.00
FE66608 x NAC SAF/SEC	Key Override	\$4,212.00	\$4,236.00
Lever with Roses: A, T, U, V, W, E2, E3, E4			
FE6618 - Classroom			
FE6620 - Privacy			
FE6622 - Store Door			
FE6624 - Storeroom Door			
FE6630 - Privacy Bath/Bedroom			
FE6662 - Classroom Security Intruder Deadbolt		\$3,832.00	\$3,856.00
FE6665 - Dormitory			
FE6672 - Classroom Security Intruder Deadbolt			
FE6673 - Classroom Security Intruder Deadbolt			
FE6675 - Security Deadbolt			
FE6680 - Passage Lever x Blank Plate			
Electrified Mortise Locks			
FE66609 x NAC SAF/SEC	Non-Key Override	\$4,032.00	\$4,056.00
FE66608 x NAC SAF/SEC	Key Override	\$4,172.00	\$4,196.00

FE6600 Series Multi-Point Locks

USA & Canada Prices Effective March 16, 2020

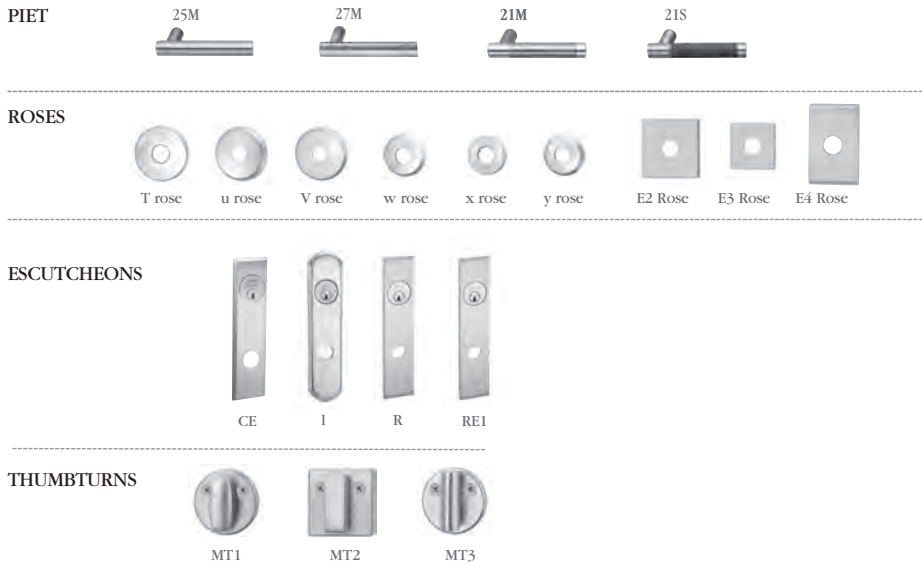

Specify thumbturn as quick code. Thumbturn backplate will match shape of rose chosen (i.e. round or square)

613E	Dark Oxidized Satin Bronze – Equivalent
629	Bright Stainless Steel
630	Satin Stainless Steel
BSP	Black Suede Powder Coat
WSP	White Suede Powder Coat

Function

Lever with Escutcheons: L, CE, RE1		
FE6618 - Classroom FE6620 - Privacy FE6622 - Store Door FE6624 - Storeroom Door FE6630 - Privacy Bath/Bedroom FE6662 - Classroom Security Intruder Deadbolt FE6665 - Dormitory FE6672 - Classroom Security Intruder Deadbolt FE6673 - Classroom Security Intruder Deadbolt FE6675 - Security Deadbolt FE6680 - Passage Lever x Blank Plate		\$3,879.00
Electrified Mortise Locks		
FE66609 x NAC SAF/SEC	Non-Key Override	\$4,079.00
FE66609 x NAC SAF/SEC	Key Override	\$4,219.00
Lever with Roses: A, T, U, V, W, E2, E3, E4		
FE6618 - Classroom FE6620 - Privacy FE6622 - Store Door FE6624 - Storeroom Door FE6630 - Privacy Bath/Bedroom FE6662 - Classroom Security Intruder Deadbolt FE6665 - Dormitory FE6672 - Classroom Security Intruder Deadbolt FE6673 - Classroom Security Intruder Deadbolt FE6675 - Security Deadbolt FE6680 - Passage Lever x Blank Plate		\$3,839.00
Electrified Mortise Locks		
FE66609 x NAC SAF/SEC	Non-Key Override	\$4,039.00
FE66608 x NAC SAF/SEC	Key Override	\$4,179.00

FE6600 Series Multi-Point Locks

USA & Canada Prices Effective March 16, 2020

PIET



ROSES



ESCUTCHEONS



THUMBTURNS



Specify thumbturn as quick code. Thumbturn backplate will match shape of rose chosen (i.e. round or square)

613E	Dark Oxidized Satin Bronze – Equivalent
629	Bright Stainless Steel
630	Satin Stainless Steel
BSP	Black Suede Powder Coat
WSP	White Suede Powder Coat

Function

Lever with Escutcheons: L, CE, RE1		
FE6618 - Classroom FE6620 - Privacy FE6622 - Store Door FE6624 - Storeroom Door FE6630 - Privacy Bath/Bedroom FE6662 - Classroom Security Intruder Deadbolt FE6665 - Dormitory FE6672 - Classroom Security Intruder Deadbolt FE6673 - Classroom Security Intruder Deadbolt FE6675 - Security Deadbolt FE6680 - Passage Lever x Blank Plate		\$3,896.00

Electrified Mortise Locks		
FE66609 x NAC SAF/SEC	Non-Key Override	\$4,056.00
FE66608 x NAC SAF/SEC	Key Override	\$4,196.00

Lever with Roses: A, T, U, V, W, E2, E3, E4		
FE6618 - Classroom FE6620 - Privacy FE6622 - Store Door FE6624 - Storeroom Door FE6630 - Privacy Bath/Bedroom FE6662 - Classroom Security Intruder Deadbolt FE6665 - Dormitory FE6672 - Classroom Security Intruder Deadbolt FE6673 - Classroom Security Intruder Deadbolt FE6675 - Security Deadbolt FE6680 - Passage Lever x Blank Plate		\$3,856.00

Electrified Mortise Locks		
FE66609 x NAC SAF/SEC	Non-Key Override	\$4,056.00
FE66608 x NAC SAF/SEC	Key Override	\$4,196.00

FE6600 Series Multi-Point Locks

USA & Canada Prices Effective March 16, 2020

Vandal Resistant Trim: ASV, CSV, DSV, ESV, LSV, NSV, PSV, RSV

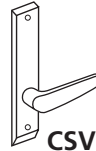

CSV

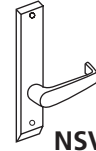

NSV

Lever: Cast
Escutcheon: Cast

Description/Function	CSV, NSV	
	Finish: 630	
FE6618 - Classroom		
FE6620 - Privacy		
FE6622 - Store Door		
FE6624 - Storeroom Door		
FE6630 - Privacy Bath/Bedroom		
FE6662 - Classroom Security Intruder Deadbolt		\$4,210.00
FE6665 - Dormitory		
FE6672 - Classroom Security Intruder Deadbolt		
FE6673 - Classroom Security Intruder Deadbolt		
FE6675 - Security Deadbolt		
FE6680 - Passage Lever x Blank Plate		
Electrified Mortise Locks		
FE66609 x NAC SAF/SEC	Non-Key Override	\$4,410.00
FE66608 x NAC SAF/SEC	Key Override	\$4,550.00

FE6600 Series Multi-Point Locks



USA & Canada Prices Effective March 16, 2020

Cylinder & Keying Options		
Description	Specify Quick Code	Add or Deduct
Conventional 6-pin	(standard)	No Charge
Conventional 7-pin	7P	Add \$2.00 per cylinder
Less Standard Cylinder	LC	Deduct \$93.00 per cylinder
Less Concealed Shell Cylinder	PO-LC	Add \$5.00 per lockset
Access 3 Patented	AP	No Charge
Access 3 Security	AS	Add \$61.00 per cylinder
Access 3 High Security, UL 437	AHS	Add \$86.00 per cylinder
Access 3 IC Patented	ACP	Add \$80.00 per cylinder
Access 3 IC Security	ACS	Add \$132.00 per cylinder
Access 3 IC High Security, UL 437	ACHS	Add \$153.00 per cylinder
Pyramid Security Fixed Core	PS	Add \$64.00 per cylinder
Pyramid Security IC	PCS	Add \$140.00 per cylinder
Pyramid High Security Fixed Core	PHS	Add \$96.00 per cylinder
Pyramid High Security IC	PCHS	Add \$171.00 per cylinder
Pyramid IC with Temporary Construction Core ³	CTP	Add \$80.00 per cylinder
Pyramid IC with Temporary Disposable Core ³	CTPD	No Charge
Pyramid IC Less Core	CLP	No Charge
Security ⁴	HS	Add \$121.00 per cylinder
Security IC ^{1,4}	CHS	Add \$199.00 per cylinder
IC 6-pin	C6	Add \$80.00 per cylinder
IC 6-pin with Temporary Construction Core (Red)	CT6R	Add \$80.00 per cylinder
IC 6-pin with Temporary Construction Core (Blue)	CT6B	Add \$80.00 per cylinder
IC 6-pin with Temporary Construction Core (Green)	CT6G	Add \$80.00 per cylinder
IC 6-pin with Temporary Disposable Core	CT6D	No Charge
IC 6-pin Less Core	CL6	No Charge
SFIC 6-pin with Less Core	CLS6	No Charge
IC 6-pin with SFIC disposable temporary core	CT6SD	No Charge
IC 7-pin	C7	Add \$82.00 per cylinder
IC 7-pin with Temporary Construction Core (Red)	CT7R	Add \$82.00 per cylinder
IC 7-pin with Temporary Construction Core (Blue)	CT7B	Add \$82.00 per cylinder
IC 7-pin with Temporary Construction Core (Green)	CT7G	Add \$82.00 per cylinder
IC 7-pin with Temporary Disposable Core	CT7D	Add \$2.00 per cylinder
IC 7-pin Less Core	CL7	Add \$2.00 per cylinder
SFIC 7-pin with Less Core	CLS7	Add \$2.00 per cylinder
IC 7-pin with SFIC disposable temporary core	CT7SD	Add \$2.00 per cylinder
Master Ring ²	MR	Add \$72.00 per cylinder
Flex Head Cylinder, 6-pin (sectional trim)	FX6	Add \$79.00 per cylinder
Flex Head Cylinder, 7-pin (sectional trim)	FX7	Add \$81.00 per cylinder
Flex Head Master Ring (sectional trim)	FXM	Add \$130.00 per cylinder
Plug only to show, 6-pin (concealed shell) (available for M and R escutcheons and single cylinder functions only)	P06	Add \$96.00 per lockset
Plug only to show, 7-pin (concealed shell) (available for M and R escutcheons and single cylinder functions only)	P07	Add \$98.00 per lockset

Notes:

1. CHS ordered with CT6 option no charge.
2. Refer to Key construction core program, pg. 63 for example of CTP option pricing.
3. For existing systems only.

FE6600 Series Multi-Point Locks



USA & Canada Prices Effective March 16, 2020

Cylinder & Keying Options* (con't)		
Description	Specify Quick Code	Add or Deduct
0-Bitted with two blank keys ⁵	(standard)	No Charge
Keyed Random ⁴	KR	No Charge
Master keyed (all cylinders except 8000, 8020, 8027 IC core)	specify keyset	Add \$16.00 per cylinder
Master keyed Pyramid	specify keyset	Add \$16.00 per cylinder
Master keyed Security (including IC cylinder and core)	specify keyset	Add \$16.00 per cylinder
Master keyed (8000, 8020, 8027 IC core)	specify keyset	No Charge
Master keyed to customer bittings or sample key	specify keyset	Add \$16.00 per cylinder
Construction master keyed ^{1,2}	CMK	Add \$16.00 per cylinder
Visual key control (VKC)		
- No Stamping	VKC0	\$4.50
- Keys only	VKC1	No Charge
- Cylinders and Keys ³	VKC2	\$8.00
- Cylinders only ³	VKC3	\$8.00
Concealed key control (CKC)		
- CKC cylinders with VKC keys	CKC2	\$8.00
- CKC cylinders only ³	CKC3	\$8.00
More than 2 keys per lock	KY# (e.g., KY6)	See page 64 - Cut Keys Section

Notes:

1. CMK Construction master keying charge is in addition to master keying charge.
2. CMK Construction master keying is not available in interchangeable core, Access 3, Pyramid, or Security series.
3. VKC2, VKC3, CKC3 are not available in Pyramid or Security series.
4. Pyramid series is not available keyed random.
5. Security series is not available 0-bitted.

Strike Options*

Lip Length	ANSI Straight Lip - Specify Quick Code	ANSI Curved Lip - Specify Quick Code	Add or Deduct
7/8"	SS078	N/A	No Charge

* If door thickness is standard or has been specified and no special door or frame condition exist, then only the first two characters of the optional strike Quick Code must be specified (e.g. "SA").

The correct lip length will be determined by our order entry system based on the standard or specified door thickness.

**FE6600 Series
Multi-Point Locks**

USA & Canada Prices Effective March 16, 2020

Door Thickness with Locksets Mortised on Center

Door Thickness	Sectional Rose Trim Specify Quick Code	Escutcheon ^{1,2} Trim Specify Quick Code	Add or Deduct
1-3/4" (standard)	—	—	No Charge

Options

Description	Specify Quick Code	Add or Deduct
Split designs and split finishes	Outside Trim x Inside Trim	Higher set price prevails
Spanner head screws	M02	Add \$21.00 per lockset
Torx® head screws (n/a with N escutcheon)	M04	Add \$26.00 per lockset
Single Occupancy Indicator - Secure/Unsecure (Outside)	M19S*	Add \$127.00 per lockset
Single Occupancy Indicator - Vacant/Occupied (Outside)	M19V*	Add \$127.00 per lockset
Double Occupancy Indicator - Secure/Unsecure (Outside) Secure/Unsecure (Inside)	M19SN*	Add \$254.00 per lockset
Double Indicator Vacant/Occupied (Outside) Secure/Unsecure (Inside)	M19VN*	Add \$254.00 per lockset
Knurling outside and inside	M20 ¹	Add \$148.00 per lockset
Knurling outside only	M21 ¹	Add \$75.00 per lockset
Knurling inside only	M22 ¹	Add \$75.00 per lockset
Abrasive coat outside and inside	M23 ¹	Add \$92.00 per lockset
Abrasive coat inside only	M24 ¹	Add \$47.00 per lockset
Abrasive coat outside only	M25 ¹	Add \$47.00 per lockset

Thumbturn Options

Specify door thickness	Specify Quick Code	Add or Deduct
Ergonomic	M34 ²	Add \$15.00 per TT
Decorative	MT1	No Charge
Decorative square	MT2	No Charge
Decorative cylinder	MT3	No Charge



MT1



MT2



MT3

Notes:

1. Not available on Vineyard™ Collection.
2. M34 is not available with M19N, M19VN or M19SN.

Note: Thumbturn backplate will match shape of rose chosen (i.e. round or square)

Strike Options

Part Number	Description
726F577	Top Strike Pack
726F587	Bottom Strike Pack
726F607	Center Strike Pack

Dogging Indicator Kit

AUX188 x FIN -Dogging Indicator kit if ordered separately

Price

\$520.00

This product is part of a complete tornado assembly and must be used with a Ceco or Curries StormPro door. Concealed vertical rods, top and bottom bolts, and mortise lock body cassette will be factory installed. All other hardware components are shipped directly to the customer and must be installed by a factory trained installer.

FE6700

Storm Shutter Multi-Point Latching System

Standard Features

USA & Canada Prices Effective March 16, 2020

Handing

Device is handed

Shutter Thickness

FE6700 is for use with standard 1-3/4" thick shutters

Cylinder Furnished with:

Brass, 6-pin, L4 keyway, 0-bitted, 1-1/8" standard for FE6755 Classroom Function. Optional cylinders available; see Quick Codes

Warranty

Seven-year limited

UL Approved

Meets FEMA P320 (2014), P361 (2015) and ICC 500-2014 for inswing shutters 2'8" w x 3'00"h min to 4'0" w x 6'8" h max.

Solid brass lever and heavy duty escutcheon

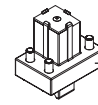

5/8" stainless steel latch housing
Through-hardened steel latchbolt
7/8" projection 5/16-18 steel
Holo-Krome® mounting screws

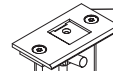

1/8" thick, through-hardened steel front

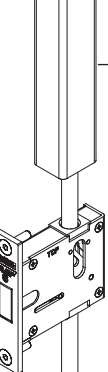

11 gage steel 12" top bolt reinforcement

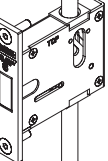

Mortised centerbolt utilizes a one-piece stainless steel, 19/32" x 1-1/4" x 1" throw bolt, 3/16" thick stainless steel front, 13 gage steel case & cap

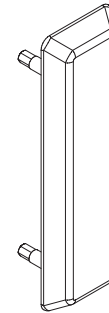
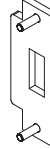
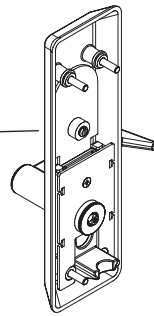

11 gage steel 12" bottom bolt reinforcement

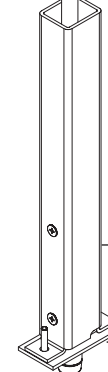

1/8" steel reinforcement plate 3/4" steel nylon coated lower bolt, 3/4" projection

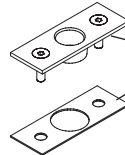

Brass bottom strike 1/4-20 steel Holo-Krome fasteners

Ordering Example

Stock Order

Quantity	Series/Function	Trim	Finish	Hand	Shutter Height
100	FE6780	FSH	626	RH	H0400

FE6700
Storm Shutter Multi-Point Latching System

USA & Canada Prices Effective March 16, 2020

Lever: Solid cast
Escutcheon: Forged

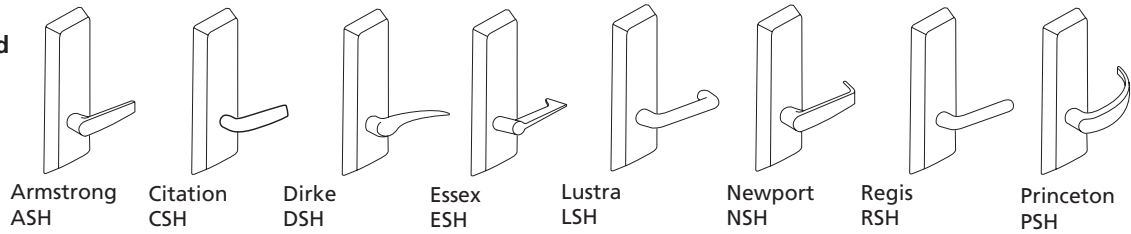

FE6700 Series

Function	Description	ASH, CSH, DSH, ESH, LSH, NSH, PSH, RSH			
		Finish Group 1		Finish Group 2	
		613E Dark Oxidized Satin Bronze	605 Polished Brass	619 Satin Nickel	
		630 Satin Stainless Steel(1)	606 Satin Brass	625 Polished Chrome	
		BSP Black Suede Powder Coat	611 Polished Bronze	629 Polished Stainless Steel(1)	
		WSP White Suede Powder Coat	612 Satin Bronze	626 Satin Chrome	
			613 Oil Rubbed Bronze	722 Black Oil Rubbed Bronze	
			618 Polished Nickel		
For Typical Shutter Applications					
FE6780	Passage Lever x Blank Plate				
Optional Functions		\$3,801.00		\$3,811.00	
FE6710	Passage or Closet				
FE6755	Classroom ³				

1. H escutcheon is a brass forging finished to match 629 and 630 finishes
3. Collar is required depending on length and type of cylinder. See Miscellaneous Options section on page 199.

Lever: Solid Cast
Escutcheon: Forged

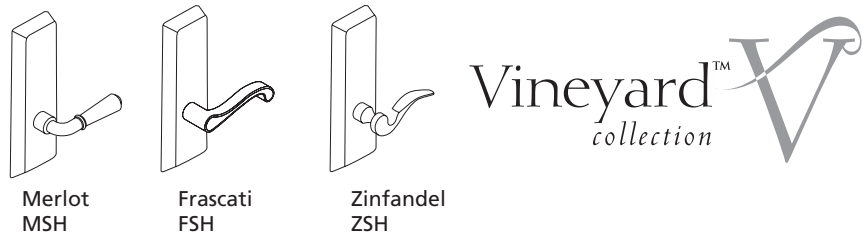

FE6700 Series

Function	Description	FSH, MSH, ZSH			
		Finish Group 1		Finish Group 2	
		613E Dark Oxidized Satin Bronze	605 Polished Brass	619 Satin Nickel	
		630 Satin Stainless Steel(1)	606 Satin Brass	625 Polished Chrome	
		BSP Black Suede Powder Coat	611 Polished Bronze	722 Black Oil Rubbed Bronze	
		WSP White Suede Powder Coat	612 Satin Bronze		
			613 Oil Rubbed Bronze		
			618 Polished Nickel		
For Typical Shutter Applications					
FE6780	Passage Lever x Blank Plate				
Optional Functions		\$3,801.00		\$3,811.00	
FE6710	Passage or Closet				
FE6755	Classroom ³				

3. Collar is required depending on length and type of cylinder. See Miscellaneous Options section on page 199.

FE6700

Storm Shutter Multi-Point Latching System



USA & Canada Prices Effective March 16, 2020

Optional Cylinder & Keying Options

Description	Specify Quick Code	Add or Deduct
Conventional 6-pin	(standard)	No Charge
Conventional 7-pin	7P	Add \$2.00 per cylinder
Access 3 Patented	AP	No Charge
Access 3 Security	AS	Add \$61.00 per cylinder
Access 3 High Security, UL 437	AHS	Add \$86.00 per cylinder
Access 3 IC Patented	ACP	Add \$80.00 per cylinder
Access 3 IC Security	ACS	Add \$132.00 per cylinder
Access 3 IC High Security, UL 437	ACHS	Add \$153.00 per cylinder
Pyramid Security Fixed Core	PS	Add \$64.00 per cylinder
Pyramid Security IC	PCS	Add \$140.00 per cylinder
Pyramid High Security Fixed Core	PHS	Add \$96.00 per cylinder
Pyramid High Security IC	PCHS	Add \$171.00 per cylinder
Pyramid IC with Temporary Construction Core ³	CTP	Add \$80.00 per cylinder
Pyramid IC with Temporary Disposable Core ³	CTPD	No Charge
Pyramid IC Less Core	CLP	No Charge
Security ⁴	HS	Add \$121.00 per cylinder
Security IC ^{1,4}	CHS	Add \$199.00 per cylinder
IC 6-pin	C6	Add \$80.00 per cylinder
IC 6-pin with Temporary Construction Core (Red)	CT6R	Add \$80.00 per cylinder
IC 6-pin with Temporary Construction Core (Blue)	CT6B	Add \$80.00 per cylinder
IC 6-pin with Temporary Construction Core (Green)	CT6G	Add \$80.00 per cylinder
IC 6-pin with Temporary Disposable Core	CT6D	No Charge
IC 6-pin Less Core	CL6	No Charge
SFIC 6-pin with Less Core	CLS6	No Charge
IC 6-pin with SFIC disposable temporary core	CT6SD	No Charge
IC 7-pin	C7	Add \$82.00 per cylinder
IC 7-pin with Temporary Construction Core (Red)	CT7R	Add \$82.00 per cylinder
IC 7-pin with Temporary Construction Core (Blue)	CT7B	Add \$82.00 per cylinder
IC 7-pin with Temporary Construction Core (Green)	CT7G	Add \$82.00 per cylinder
IC 7-pin with Temporary Disposable Core	CT7D	Add \$2.00 per cylinder
IC 7-pin Less Core	CL7	Add \$2.00 per cylinder
SFIC 7-pin with Less Core	CLS7	Add \$2.00 per cylinder
IC 7-pin with SFIC disposable temporary core	CT7SD	Add \$2.00 per cylinder

*Optional dogging cylinder will be furnished with the same mechanism and keyed alike with the trim cylinder, unless otherwise specified. If different keying or cylinder type is required, specify outside (trim) first, then inside (dogging) cylinder.
 **6P cylinder option is supplied in 6-pin, L4 keyway, 0-bitted with two nickel silver keys.

FE6700

Storm Shutter Multi-Point Latching System



Optional Cylinder & Keying Options (con't)

USA & Canada Prices Effective March 16, 2020

Description	Specify	Add or Deduct
0-Bitted with two blank keys ⁵	(standard)	No Charge
Keyed Random ⁴	KR	No Charge
Master keyed (all cylinders except 8000, 8020, 8027 IC core)	specify keyset	Add \$16.00 per cylinder
Master keyed Pyramid	specify keyset	Add \$16.00 per cylinder
Master keyed Security (including IC cylinder and core)	specify keyset	Add \$16.00 per cylinder
Master keyed (8000, 8020, 8027 IC core)	specify keyset	No Charge
Master keyed to customer bittings or sample key	specify keyset	Add \$16.00 per cylinder
Construction master keyed ^{1,2}	CMK	Add \$16.00 per cylinder
Visual key control (VKC)		
- No Stamping	VKC0	\$4.50
- Keys only	VKC1	No Charge
- Cylinders and Keys ³	VKC2	\$8.00
- Cylinders only ³	VKC3	\$8.00
Concealed key control (CKC)		
- CKC cylinders with VKC keys	CKC2	\$8.00
- CKC cylinders only ³	CKC3	\$8.00
More than 2 keys per lock	KY# (e.g., KY6)	See page 66 - Cut Keys Section

Notes:

1. CMK Construction master keying charge is in addition to master keying charge.
2. CMK Construction master keying is not available in interchangeable core, Access 3, Pyramid, or Security series.
3. VKC2, VKC3, CKC3 are not available in Pyramid or Security series.
4. Pyramid series is not available keyed random.
5. Security series is not available 0-bitted.

Shutter Thickness

Description	Specify
1-3/4"	(standard)

Shutter Height Options

Description	Specify
2'8" - 4'6"	H0400
4'6" - 6'8"	H0500

Miscellaneous Options

Description	Specify	Add or Deduct
Torx Screws	M04	Add \$21.00 per lockset
1-1/8" cylinder collar (for 6-pin mortise cylinder) ¹²	721F36	No Charge
1-1/4" cylinder collar (for 7-pin mortise cylinder) ¹²	721F37	No Charge
1-1/2" cylinder collar (for 7-pin IC mortise cylinder) ¹²	721F38	No Charge
MicroShield® Antimicrobial finish coating	630C	Add \$86.00 per lockset
MicroShield Antimicrobial finish coating	626C	Add \$86.00 per lockset

Notes:

1. For optional FE6755 classroom function, collar is required depending on length and type of cylinder.
2. Specify as optional collar when ordering cylinders only.

MP9800 Series

Multi-Point Vertical Rod Lock

USA & Canada Prices Effective March 16, 2020

Standard Features

Handing

Field Reversible.

Doors

1-3/4" (44mm) door thickness standard,
2-1/4" backset standard.

Mounting

Supplied fasteners are for metal doors with through-bolts for trim.

Rods

Steel. Top and bottom bolt travels 7/16" (11mm)
Projection adjustable up to 3/4" (19mm).

Latching

Top and Bottom or Top only (M55).

Trim

Available with all lever designs.

Cylinder

See cylinders page 12.

Applications

Single or Double Door.

Thermal Pins

MP9800A x M55: devices are supplied with ONE thermal pin per
fire-rated device, for installation on pairs of fire-rated doors.

Warranty

5 year.



Featuring Ecoflex Technology

Available Function Combinations:	Outside Function (E)	Inside Function (N)								
		10	45*	49*	50	52	55*	59*	903*	905*
Blank Escutcheon Plate	01	X	X	X			X	X	X	X
Passage only (No cylinder)	10	X	X	X			X	X		
No outside Operation (No Cylinder); Pull Only	40+	X	X	X					X	X
Class Room Key Outside Unlocks/locks Trim	45	X	X	X						
Key unlocks Trim; Trim retracts latch; Trim relocks when key is removed	49	X	X	X					X	X
Freewheeling Trim; No Outside Operation	50						X	X		
Key outside unlocks/locks O/S trim; Key inside unlocks/locks O/S trim	52					X				
Freewheeling Trim; Key Outside Unlocks/locks Trim	55	X			X		X	X		
Freewheeling Trim; Key unlocks Trim; Trim retracts latch/Trim relocks when key is removed	59	X			X		X	X		
Electrified Trim - Fail Safe	903	X	X	X					X	X
Electrified Trim - Fail Secure	905	X	X	X					X	X

* Not recommended for use on any door used for Life Safety egress + Rigid lever

*Specify voltage desired for 903 and 905 functions (12VDC/24VDC)

Ordering Examples

Qty	Device	Exterior Trim/Function			Interior Trim/Function			Finish	Hand	Door Thickness	Door Height	Misc. Options	Voltage for Electrified Trim
		Lever	Exterior	Function	Lever	Interior	Function						
65	MP9800	D	E	49	D	N	10	605	LHR	D214	H0800	M55	12V

Contract/Detailed Order

Qty	Keyset	Series	Exterior Trim/Function			Interior Trim/Function			Finish	Hand	Door Thickness	Door Hght	Misc. Opts	Cyl Opts	Voltage for Electrified Trim
			Lever	Exterior	Function	Lever	Interior	Function							
36	AA1	MP9800A	101	E	50	101	N	55	626	LHR	D214	H1000	M93	7P	12V

Experience a safer
and more open world

MP9800 Series Multi-Point Vertical Rod Lock

Lever: Solid Cast
Escutcheon: Forged

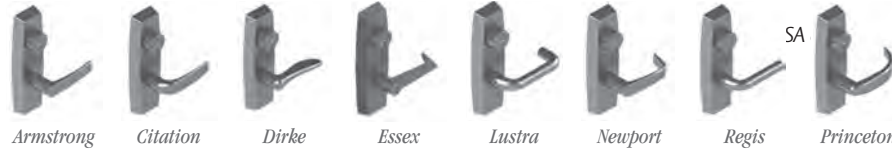

SA

Prices Effective March 16, 2020

GEORGIA	101	102	103	104	124	125	JOSEF	133	134
PABLO	117	126							
JACKSON	105	119	121	122	127				
SALVADOR	106	107	108	109	110	123	128		
MARC	111	112	113	114	115	116	130	131	132

Note: Must designate E for exterior function or N for interior function when specifying order.

MP9800		613E, 626, BSP, WSP	605 606 611 612 613 618 625
Lever (E) x 01 x Lever (N) x *49	Blank Escutcheon Plate		
Lever (E) x 01 x Lever (N) x *45	Blank Escutcheon Plate		
Lever (E) x 01 x Lever (N) x 10	Blank Escutcheon Plate		
Lever (E) x 01 x Lever (N) x *55	Blank Escutcheon Plate		
Lever (E) x 01 x Lever (N) x 59	Blank Escutcheon Plate		
Lever (E) x 10 x Lever (N) x *49	Passage only (No cylinder)		
Lever (E) x 10 x Lever (N) x *45	Passage only (No cylinder)		
Lever (E) x 10 x Lever (N) x 10	Passage only (No cylinder)		
Lever (E) x 10 x Lever (N) x *55	Passage only (No cylinder)		
Lever (E) x 10 x Lever (N) x *59	Passage only (No cylinder)	\$2,189.00	\$2,269.00
Lever (E) x 40 x Lever (N) x *49	No outside Operation (No Cylinder); Pull Only		
Lever (E) x 40 x Lever (N) x *45	No outside Operation (No Cylinder); Pull Only		
Lever (E) x 40 x Lever (N) x 10	No outside Operation (No Cylinder); Pull Only		
Lever (E) x 45 x Lever (N) x *49	Class Room Key Outside Unlocks/locks Trim		
Lever (E) x 45 x Lever (N) x *45	Class Room Key Outside Unlocks/locks Trim		
Lever (E) x 45 x Lever (N) x 10	Class Room Key Outside Unlocks/locks Trim		
Lever (E) x 49 x Lever (N) x *10	Key unlocks Trim; Trim retracts latch; Trim relocks when key is removed		
Lever (E) x 49 x Lever (N) x *45	Key unlocks Trim; Trim retracts latch; Trim relocks when key is removed		
Lever (E) x 49 x Lever (N) x *49	Key unlocks Trim; Trim retracts latch; Trim relocks when key is removed		

* Not recommended for use on any door used for Life Safety egress.

MP9800 Series

Multi-Point Vertical Rod Lock



USA & Canada Prices Effective March 16, 2020

MP9800 Freewheeling Trim		613E, 626, BSP, WSP	605 606 611 612 613 618 625
Lever (E) x 50 x Lever (N) x *55	Freewheeling Trim; No Outside Operation	\$2,189.00	\$2,269.00
Lever (E) x 50 x Lever (N) x *59	Freewheeling Trim; No Outside Operation		
Lever (E) x 52 x Lever (N) x 52	Key outside unlocks/locks O/S trim; Key inside unlocks/locks O/S trim		
Lever (E) x 55 x Lever (N) x *10	Freewheeling Trim; Key Outside Unlocks/locks Trim		
Lever (E) x 55 x Lever (N) x 50	Freewheeling Trim; Key Outside Unlocks/locks Trim		
Lever (E) x 55 x Lever (N) x *55	Freewheeling Trim; Key Outside Unlocks/locks Trim		
Lever (E) x 55 x Lever (N) x *59	Freewheeling Trim; Key Outside Unlocks/locks Trim		
Lever (E) x 59 x Lever (N) x *10	Freewheeling Trim; Key unlocks Trim; Trim retracts latch/Trim relocks when key is removed		
Lever (E) x 59 x Lever (N) x 50	Freewheeling Trim; Key unlocks Trim; Trim retracts latch/Trim relocks when key is removed		
Lever (E) x 59 x Lever (N) x *55	Freewheeling Trim; Key unlocks Trim; Trim retracts latch/Trim relocks when key is removed		
Lever (E) x 59 x Lever (N) x *59	Freewheeling Trim; Key unlocks Trim; Trim retracts latch/Trim relocks when key is removed		
MP9800 Electromechanical			
Lever (E) x 01 x Lever (N) x *903	Blank Escutcheon Plate	\$2,356.00	\$2,436.00
Lever (E) x 01 x Lever (N) x *905	Blank Escutcheon Plate		
Lever (E) x 40 x Lever (N) x *903	No outside Operation (No Cylinder); Pull Only		
Lever (E) x 40 x Lever (N) x *905	No outside Operation (No Cylinder); Pull Only		
Lever (E) x 49 x Lever (N) x *903	Key unlocks Trim; Trim retracts latch; Trim relocks when key is removed		
Lever (E) x 49 x Lever (N) x *905	Key unlocks Trim; Trim retracts latch; Trim relocks when key is removed		
Lever (E) x 903 x Lever (N) x 10	Electrified Trim - Fail Safe	\$2,523.00	\$2,603.00
Lever (E) x 903 x Lever (N) x *45	Electrified Trim - Fail Safe		
Lever (E) x 905 x Lever (N) x 10	Electrified Trim - Fail Secure		
Lever (E) x 905 x Lever (N) x *45	Electrified Trim - Fail Secure		
Lever (E) x 905 x Lever (N) x *903	Electrified Trim - Fail Secure		
Lever (E) x 905 x Lever (N) x *905	Electrified Trim - Fail Secure		
Lever (E) x 903 x Lever (N) x *903	Electrified Trim - Fail Safe		
Lever (E) x 903 x Lever (N) x *905	Electrified Trim - Fail Safe		

* Not recommended for use on any door used for Life Safety egress.

MP9800 Series Multi-Point Vertical Rod Lock

Lever: Solid Cast
Escutcheon: Forged

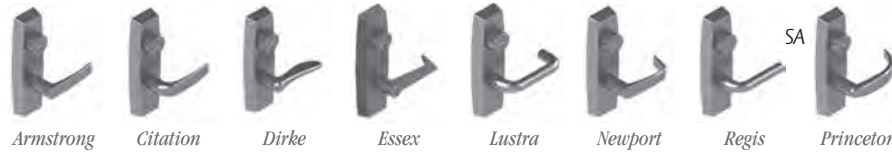

SA

Prices Effective March 16, 2020

GEORGIA	101	102	103	104	124	125	JOSEF	133	134
PABLO	117	126							
JACKSON	105	119	121	122	127				
SALVADOR	106	107	108	109	110	123	128		
MARC	111	112	113	114	115	116	130	131	132

Note: Must designate E for exterior function or N for interior function when specifying order.

MP9800A		613E, 626, BSP, WSP	605 606 611 612 613 618 625
Lever (E) x 01 x Lever (N) x *49	Blank Escutcheon Plate		
Lever (E) x 01 x Lever (N) x *45	Blank Escutcheon Plate		
Lever (E) x 01 x Lever (N) x 10	Blank Escutcheon Plate		
Lever (E) x 01 x Lever (N) x *55	Blank Escutcheon Plate		
Lever (E) x 01 x Lever (N) x *59	Blank Escutcheon Plate		
Lever (E) x 10 x Lever (N) x *49	Passage only (No cylinder)		
Lever (E) x 10 x Lever (N) x *45	Passage only (No cylinder)		
Lever (E) x 10 x Lever (N) x 10	Passage only (No cylinder)		
Lever (E) x 10 x Lever (N) x *55	Passage only (No cylinder)		
Lever (E) x 10 x Lever (N) x *59	Passage only (No cylinder)	\$2,359.00	\$2,439.00
Lever (E) x 40 x Lever (N) x *49	No outside Operation (No Cylinder); Pull Only		
Lever (E) x 40 x Lever (N) x *45	No outside Operation (No Cylinder); Pull Only		
Lever (E) x 40 x Lever (N) x 10	No outside Operation (No Cylinder); Pull Only		
Lever (E) x 45 x Lever (N) x *49	Class Room Key Outside Unlocks/locks Trim		
Lever (E) x 45 x Lever (N) x *45	Class Room Key Outside Unlocks/locks Trim		
Lever (E) x 45 x Lever (N) x 10	Class Room Key Outside Unlocks/locks Trim		
Lever (E) x 49 x Lever (N) x *10	Key unlocks Trim; Trim retracts latch; Trim relocks when key is removed		
Lever (E) x 49 x Lever (N) x *45	Key unlocks Trim; Trim retracts latch; Trim relocks when key is removed		
Lever (E) x 49 x Lever (N) x *49	Key unlocks Trim; Trim retracts latch; Trim relocks when key is removed		

* Not recommended for use on any door used for Life Safety egress.

MP9800 Series

Multi-Point Vertical Rod Lock



USA & Canada Prices Effective March 16, 2020

MP9800A Freewheeling Trim		613E, 626, BSP, WSP	605 606 611 612 613 618 625
Lever (E) x 50 x Lever (N) x *55	Freewheeling Trim; No Outside Operation	\$2,359.00	\$2,439.00
Lever (E) x 50 x Lever (N) x *59	Freewheeling Trim; No Outside Operation		
Lever (E) x 52 x Lever (N) x 52	Key outside unlocks/locks O/S trim; Key inside unlocks/locks O/S trim		
Lever (E) x 55 x Lever (N) x *10	Freewheeling Trim; Key Outside Unlocks/locks Trim		
Lever (E) x 55 x Lever (N) x 50	Freewheeling Trim; Key Outside Unlocks/locks Trim		
Lever (E) x 55 x Lever (N) x *55	Freewheeling Trim; Key Outside Unlocks/locks Trim		
Lever (E) x 55 x Lever (N) x *59	Freewheeling Trim; Key Outside Unlocks/locks Trim		
Lever (E) x 59 x Lever (N) x *10	Freewheeling Trim; Key unlocks Trim; Trim retracts latch/Trim relocks when key is removed		
Lever (E) x 59 x Lever (N) x 50	Freewheeling Trim; Key unlocks Trim; Trim retracts latch/Trim relocks when key is removed		
Lever (E) x 59 x Lever (N) x *55	Freewheeling Trim; Key unlocks Trim; Trim retracts latch/Trim relocks when key is removed		
Lever (E) x 59 x Lever (N) x *59	Freewheeling Trim; Key unlocks Trim; Trim retracts latch/Trim relocks when key is removed		
MP9800A Electromechanical			
Lever (E) x 01 x Lever (N) x *903	Blank Escutcheon Plate		
Lever (E) x 01 x Lever (N) x *905	Blank Escutcheon Plate		
Lever (E) x 40 x Lever (N) x *903	No outside Operation (No Cylinder); Pull Only		
Lever (E) x 40 x Lever (N) x *905	No outside Operation (No Cylinder); Pull Only		
Lever (E) x 49 x Lever (N) x *903	Key unlocks Trim; Trim retracts latch; Trim relocks when key is removed		
Lever (E) x 49 x Lever (N) x *905	Key unlocks Trim; Trim retracts latch; Trim relocks when key is removed		
Lever (E) x 903 x Lever (N) x 10	Electrified Trim - Fail Safe		
Lever (E) x 903 x Lever (N) x *45	Electrified Trim - Fail Safe		
Lever (E) x 905 x Lever (N) x 10	Electrified Trim - Fail Secure		
Lever (E) x 905 x Lever (N) x *45	Electrified Trim - Fail Secure		
Lever (E) x 905 x Lever (N) x *903	Electrified Trim - Fail Secure	\$2,693.00	\$2,773.00
Lever (E) x 905 x Lever (N) x *905	Electrified Trim - Fail Secure		
Lever (E) x 903 x Lever (N) x *903	Electrified Trim - Fail Safe		
Lever (E) x 903 x Lever (N) x *905	Electrified Trim - Fail Safe		

* Not recommended for use on any door used for Life Safety egress.

MP9800 Series
Multi-Point Vertical Rod Lock

USA & Canada Prices Effective March 16, 2020



MP9800		613E, 629, 630, BSP, WSP
	Piet 21G, 21L, 21M, 21S, 23M, 25M, 27M	
Lever (E) x 01 x Lever (N) x *49	Blank Escutcheon Plate	\$2,373.00
Lever (E) x 01 x Lever (N) x *45	Blank Escutcheon Plate	
Lever (E) x 01 x Lever (N) x 10	Blank Escutcheon Plate	
Lever (E) x 01 x Lever (N) x *55	Blank Escutcheon Plate	
Lever (E) x 01 x Lever (N) x 59	Blank Escutcheon Plate	
Lever (E) x 10 x Lever (N) x *49	Passage only (No cylinder)	
Lever (E) x 10 x Lever (N) x *45	Passage only (No cylinder)	
Lever (E) x 10 x Lever (N) x 10	Passage only (No cylinder)	
Lever (E) x 10 x Lever (N) x *55	Passage only (No cylinder)	
Lever (E) x 10 x Lever (N) x *59	Passage only (No cylinder)	
Lever (E) x 40 x Lever (N) x *49	No outside Operation (No Cylinder); Pull Only	
Lever (E) x 40 x Lever (N) x *45	No outside Operation (No Cylinder); Pull Only	
Lever (E) x 40 x Lever (N) x 10	No outside Operation (No Cylinder); Pull Only	
Lever (E) x 45 x Lever (N) x *49	Class Room Key Outside Unlocks/locks Trim	
Lever (E) x 45 x Lever (N) x *45	Class Room Key Outside Unlocks/locks Trim	
Lever (E) x 45 x Lever (N) x 10	Class Room Key Outside Unlocks/locks Trim	
Lever (E) x 49 x Lever (N) x *10	Key unlocks Trim; Trim retracts latch; Trim relocks when key is removed	
Lever (E) x 49 x Lever (N) x *45	Key unlocks Trim; Trim retracts latch; Trim relocks when key is removed	
Lever (E) x 49 x Lever (N) x *49	Key unlocks Trim; Trim retracts latch; Trim relocks when key is removed	
MP9800 Freewheeling Trim		
Lever (E) x 50 x Lever (N) x *55	Freewheeling Trim; No Outside Operation	\$2,373.00
Lever (E) x 50 x Lever (N) x *59	Freewheeling Trim; No Outside Operation	
Lever (E) x 52 x Lever (N) x 52	Key outside unlocks/locks O/S trim; Key inside unlocks/locks O/S trim	
Lever (E) x 55 x Lever (N) x *10	Freewheeling Trim; Key Outside Unlocks/locks Trim	
Lever (E) x 55 x Lever (N) x 50	Freewheeling Trim; Key Outside Unlocks/locks Trim	
Lever (E) x 55 x Lever (N) x *55	Freewheeling Trim; Key Outside Unlocks/locks Trim	
Lever (E) x 55 x Lever (N) x *59	Freewheeling Trim; Key Outside Unlocks/locks Trim	
Lever (E) x 59 x Lever (N) x *10	Freewheeling Trim; Key unlocks Trim; Trim retracts latch/Trim relocks when key is removed	
Lever (E) x 59 x Lever (N) x 50	Freewheeling Trim; Key unlocks Trim; Trim retracts latch/Trim relocks when key is removed	
Lever (E) x 59 x Lever (N) x *55	Freewheeling Trim; Key unlocks Trim; Trim retracts latch/Trim relocks when key is removed	
Lever (E) x 59 x Lever (N) x *59	Freewheeling Trim; Key unlocks Trim; Trim retracts latch/Trim relocks when key is removed	
MP9800 Electromechanical		
Lever (E) x 01 x Lever (N) x *903	Blank Escutcheon Plate	\$2,540.00
Lever (E) x 01 x Lever (N) x *905	Blank Escutcheon Plate	
Lever (E) x 40 x Lever (N) x *903	No outside Operation (No Cylinder); Pull Only	
Lever (E) x 40 x Lever (N) x *905	No outside Operation (No Cylinder); Pull Only	
Lever (E) x 49 x Lever (N) x *903	Key unlocks Trim; Trim retracts latch; Trim relocks when key is removed	
Lever (E) x 49 x Lever (N) x *905	Key unlocks Trim; Trim retracts latch; Trim relocks when key is removed	
Lever (E) x 903 x Lever (N) x 10	Electrified Trim - Fail Safe	
Lever (E) x 903 x Lever (N) x *45	Electrified Trim - Fail Safe	
Lever (E) x 905 x Lever (N) x 10	Electrified Trim - Fail Secure	
Lever (E) x 905 x Lever (N) x *45	Electrified Trim - Fail Secure	
Lever (E) x 905 x Lever (N) x *903	Electrified Trim - Fail Secure	\$2,707.00
Lever (E) x 905 x Lever (N) x *905	Electrified Trim - Fail Secure	
Lever (E) x 903 x Lever (N) x *903	Electrified Trim - Fail Safe	
Lever (E) x 903 x Lever (N) x *905	Electrified Trim - Fail Safe	

* Not recommended for use on any door used for Life Safety egress.

MP9800 Series

Multi-Point Vertical Rod Lock

USA & Canada Prices Effective March 16, 2020



MP9800A		613E, 629, 630, BSP, WSP
	Piet 21G, 21L, 21M, 21S, 23M, 25M, 27M	
Lever (E) x 01 x Lever (N) x *49	Blank Escutcheon Plate	\$2,543.00
Lever (E) x 01 x Lever (N) x *45	Blank Escutcheon Plate	
Lever (E) x 01 x Lever (N) x 10	Blank Escutcheon Plate	
Lever (E) x 01 x Lever (N) x *55	Blank Escutcheon Plate	
Lever (E) x 01 x Lever (N) x 59	Blank Escutcheon Plate	
Lever (E) x 10 x Lever (N) x *49	Passage only (No cylinder)	
Lever (E) x 10 x Lever (N) x *45	Passage only (No cylinder)	
Lever (E) x 10 x Lever (N) x 10	Passage only (No cylinder)	
Lever (E) x 10 x Lever (N) x *55	Passage only (No cylinder)	
Lever (E) x 10 x Lever (N) x *59	Passage only (No cylinder)	
Lever (E) x 40 x Lever (N) x *49	No outside Operation (No Cylinder); Pull Only	
Lever (E) x 40 x Lever (N) x *45	No outside Operation (No Cylinder); Pull Only	
Lever (E) x 40 x Lever (N) x 10	No outside Operation (No Cylinder); Pull Only	
Lever (E) x 45 x Lever (N) x *49	Class Room Key Outside Unlocks/locks Trim	
Lever (E) x 45 x Lever (N) x *45	Class Room Key Outside Unlocks/locks Trim	
Lever (E) x 45 x Lever (N) x 10	Class Room Key Outside Unlocks/locks Trim	
Lever (E) x 49 x Lever (N) x *10	Key unlocks Trim; Trim retracts latch; Trim relocks when key is removed	
Lever (E) x 49 x Lever (N) x *45	Key unlocks Trim; Trim retracts latch; Trim relocks when key is removed	
Lever (E) x 49 x Lever (N) x *49	Key unlocks Trim; Trim retracts latch; Trim relocks when key is removed	
MP9800A Freewheeling Trim		
Lever (E) x 50 x Lever (N) x *55	Freewheeling Trim; No Outside Operation	\$2,543.00
Lever (E) x 50 x Lever (N) x *59	Freewheeling Trim; No Outside Operation	
Lever (E) x 52 x Lever (N) x 52	Key outside unlocks/locks O/S trim; Key inside unlocks/locks O/S trim	
Lever (E) x 55 x Lever (N) x *10	Freewheeling Trim; Key Outside Unlocks/locks Trim	
Lever (E) x 55 x Lever (N) x 50	Freewheeling Trim; Key Outside Unlocks/locks Trim	
Lever (E) x 55 x Lever (N) x *55	Freewheeling Trim; Key Outside Unlocks/locks Trim	
Lever (E) x 55 x Lever (N) x *59	Freewheeling Trim; Key Outside Unlocks/locks Trim	
Lever (E) x 59 x Lever (N) x *10	Freewheeling Trim; Key unlocks Trim; Trim retracts latch/Trim relocks when key is removed	
Lever (E) x 59 x Lever (N) x 50	Freewheeling Trim; Key unlocks Trim; Trim retracts latch/Trim relocks when key is removed	
Lever (E) x 59 x Lever (N) x *55	Freewheeling Trim; Key unlocks Trim; Trim retracts latch/Trim relocks when key is removed	
Lever (E) x 59 x Lever (N) x *59	Freewheeling Trim; Key unlocks Trim; Trim retracts latch/Trim relocks when key is removed	
MP9800A Electromechanical		
Lever (E) x 01 x Lever (N) x *903	Blank Escutcheon Plate	\$2,710.00
Lever (E) x 01 x Lever (N) x *905	Blank Escutcheon Plate	
Lever (E) x 40 x Lever (N) x *903	No outside Operation (No Cylinder); Pull Only	
Lever (E) x 40 x Lever (N) x *905	No outside Operation (No Cylinder); Pull Only	
Lever (E) x 49 x Lever (N) x *903	Key unlocks Trim; Trim retracts latch; Trim relocks when key is removed	
Lever (E) x 49 x Lever (N) x *905	Key unlocks Trim; Trim retracts latch; Trim relocks when key is removed	
Lever (E) x 903 x Lever (N) x 10	Electrified Trim - Fail Safe	
Lever (E) x 903 x Lever (N) x *45	Electrified Trim - Fail Safe	
Lever (E) x 905 x Lever (N) x 10	Electrified Trim - Fail Secure	
Lever (E) x 905 x Lever (N) x *45	Electrified Trim - Fail Secure	
Lever (E) x 905 x Lever (N) x *903	Electrified Trim - Fail Secure	\$2,877.00
Lever (E) x 905 x Lever (N) x *905	Electrified Trim - Fail Secure	
Lever (E) x 903 x Lever (N) x *903	Electrified Trim - Fail Safe	
Lever (E) x 903 x Lever (N) x *905	Electrified Trim - Fail Safe	

* Not recommended for use on any door used for Life Safety egress.

MP9800 Series

Multi-Point Vertical Rod Lock

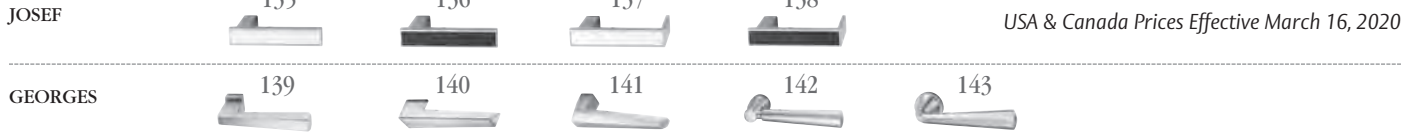

USA & Canada Prices Effective March 16, 2020

MP9800		613E, 626, BSP, WSP	605 606 611 612 613 618 625
	Josef, Georges Levers		
Lever (E) x 01 x Lever (N) x *49	Blank Escutcheon Plate		
Lever (E) x 01 x Lever (N) x *45	Blank Escutcheon Plate		
Lever (E) x 01 x Lever (N) x 10	Blank Escutcheon Plate		
Lever (E) x 01 x Lever (N) x *55	Blank Escutcheon Plate		
Lever (E) x 01 x Lever (N) x 59	Blank Escutcheon Plate		
Lever (E) x 10 x Lever (N) x *49	Passage only (No cylinder)		
Lever (E) x 10 x Lever (N) x *45	Passage only (No cylinder)		
Lever (E) x 10 x Lever (N) x 10	Passage only (No cylinder)		
Lever (E) x 10 x Lever (N) x *55	Passage only (No cylinder)		
Lever (E) x 10 x Lever (N) x *59	Passage only (No cylinder)	\$2,296.00	\$2,373.00
Lever (E) x 40 x Lever (N) x *49	No outside Operation (No Cylinder); Pull Only		
Lever (E) x 40 x Lever (N) x *45	No outside Operation (No Cylinder); Pull Only		
Lever (E) x 40 x Lever (N) x 10	No outside Operation (No Cylinder); Pull Only		
Lever (E) x 45 x Lever (N) x *49	Class Room Key Outside Unlocks/locks Trim		
Lever (E) x 45 x Lever (N) x *45	Class Room Key Outside Unlocks/locks Trim		
Lever (E) x 45 x Lever (N) x 10	Class Room Key Outside Unlocks/locks Trim		
Lever (E) x 49 x Lever (N) x *10	Key unlocks Trim; Trim retracts latch; Trim relocks when key is removed		
Lever (E) x 49 x Lever (N) x *45	Key unlocks Trim; Trim retracts latch; Trim relocks when key is removed		
Lever (E) x 49 x Lever (N) x *49	Key unlocks Trim; Trim retracts latch; Trim relocks when key is removed		
MP9800 Freewheeling Trim			
Lever (E) x 50 x Lever (N) x *55	Freewheeling Trim; No Outside Operation		
Lever (E) x 50 x Lever (N) x *59	Freewheeling Trim; No Outside Operation		
Lever (E) x 52 x Lever (N) x 52	Key outside unlocks/locks O/S trim; Key inside unlocks/locks O/S trim		
Lever (E) x 55 x Lever (N) x *10	Freewheeling Trim; Key Outside Unlocks/locks Trim		
Lever (E) x 55 x Lever (N) x 50	Freewheeling Trim; Key Outside Unlocks/locks Trim		
Lever (E) x 55 x Lever (N) x *55	Freewheeling Trim; Key Outside Unlocks/locks Trim	\$2,296.00	\$2,373.00
Lever (E) x 55 x Lever (N) x *59	Freewheeling Trim; Key Outside Unlocks/locks Trim		
Lever (E) x 59 x Lever (N) x *10	Freewheeling Trim; Key unlocks Trim; Trim retracts latch/Trim relocks when key is removed		
Lever (E) x 59 x Lever (N) x 50	Freewheeling Trim; Key unlocks Trim; Trim retracts latch/Trim relocks when key is removed		
Lever (E) x 59 x Lever (N) x *55	Freewheeling Trim; Key unlocks Trim; Trim retracts latch/Trim relocks when key is removed		
Lever (E) x 59 x Lever (N) x *59	Freewheeling Trim; Key unlocks Trim; Trim retracts latch/Trim relocks when key is removed		
MP9800 Electromechanical			
Lever (E) x 01 x Lever (N) x *903	Blank Escutcheon Plate		
Lever (E) x 01 x Lever (N) x *905	Blank Escutcheon Plate		
Lever (E) x 40 x Lever (N) x *903	No outside Operation (No Cylinder); Pull Only		
Lever (E) x 40 x Lever (N) x *905	No outside Operation (No Cylinder); Pull Only		
Lever (E) x 49 x Lever (N) x *903	Key unlocks Trim; Trim retracts latch; Trim relocks when key is removed	\$2,463.00	\$2,540.00
Lever (E) x 49 x Lever (N) x *905	Key unlocks Trim; Trim retracts latch; Trim relocks when key is removed		
Lever (E) x 903 x Lever (N) x 10	Electrified Trim - Fail Safe		
Lever (E) x 903 x Lever (N) x *45	Electrified Trim - Fail Safe		
Lever (E) x 905 x Lever (N) x 10	Electrified Trim - Fail Secure		
Lever (E) x 905 x Lever (N) x *45	Electrified Trim - Fail Secure		
Lever (E) x 905 x Lever (N) x *903	Electrified Trim - Fail Secure		
Lever (E) x 905 x Lever (N) x *905	Electrified Trim - Fail Secure	\$2,630.00	\$2,707.00
Lever (E) x 903 x Lever (N) x *903	Electrified Trim - Fail Safe		
Lever (E) x 903 x Lever (N) x *905	Electrified Trim - Fail Safe		

MP9800 Series

Multi-Point Vertical Rod Lock

JOSEF



USA & Canada Prices Effective March 16, 2020

GEORGES



MP9800A

	Josef, Georges Levers	613E, 626, BSP, WSP	605 606 611 612 613 618 625
Lever (E) x 01 x Lever (N) x *49	Blank Escutcheon Plate		
Lever (E) x 01 x Lever (N) x *45	Blank Escutcheon Plate		
Lever (E) x 01 x Lever (N) x 10	Blank Escutcheon Plate		
Lever (E) x 01 x Lever (N) x *55	Blank Escutcheon Plate		
Lever (E) x 01 x Lever (N) x 59	Blank Escutcheon Plate		
Lever (E) x 10 x Lever (N) x *49	Passage only (No cylinder)		
Lever (E) x 10 x Lever (N) x *45	Passage only (No cylinder)		
Lever (E) x 10 x Lever (N) x 10	Passage only (No cylinder)		
Lever (E) x 10 x Lever (N) x *55	Passage only (No cylinder)		
Lever (E) x 10 x Lever (N) x *59	Passage only (No cylinder)	\$2,466.00	\$2,536.00
Lever (E) x 40 x Lever (N) x *49	No outside Operation (No Cylinder); Pull Only		
Lever (E) x 40 x Lever (N) x *45	No outside Operation (No Cylinder); Pull Only		
Lever (E) x 40 x Lever (N) x 10	No outside Operation (No Cylinder); Pull Only		
Lever (E) x 45 x Lever (N) x *49	Class Room Key Outside Unlocks/locks Trim		
Lever (E) x 45 x Lever (N) x *45	Class Room Key Outside Unlocks/locks Trim		
Lever (E) x 45 x Lever (N) x 10	Class Room Key Outside Unlocks/locks Trim		
Lever (E) x 49 x Lever (N) x *10	Key unlocks Trim; Trim retracts latch; Trim relocks when key is removed		
Lever (E) x 49 x Lever (N) x *45	Key unlocks Trim; Trim retracts latch; Trim relocks when key is removed		
Lever (E) x 49 x Lever (N) x *49	Key unlocks Trim; Trim retracts latch; Trim relocks when key is removed		

MP9800A Freewheeling Trim

Lever (E) x 50 x Lever (N) x *55	Freewheeling Trim; No Outside Operation		
Lever (E) x 50 x Lever (N) x *59	Freewheeling Trim; No Outside Operation		
Lever (E) x 52 x Lever (N) x 52	Key outside unlocks/locks O/S trim; Key inside unlocks/locks O/S trim		
Lever (E) x 55 x Lever (N) x *10	Freewheeling Trim; Key Outside Unlocks/locks Trim		
Lever (E) x 55 x Lever (N) x 50	Freewheeling Trim; Key Outside Unlocks/locks Trim		
Lever (E) x 55 x Lever (N) x *55	Freewheeling Trim; Key Outside Unlocks/locks Trim	\$2,466.00	\$2,536.00
Lever (E) x 55 x Lever (N) x *59	Freewheeling Trim; Key Outside Unlocks/locks Trim		
Lever (E) x 59 x Lever (N) x *10	Freewheeling Trim; Key unlocks Trim; Trim retracts latch/Trim relocks when key is removed		
Lever (E) x 59 x Lever (N) x 50	Freewheeling Trim; Key unlocks Trim; Trim retracts latch/Trim relocks when key is removed		
Lever (E) x 59 x Lever (N) x *55	Freewheeling Trim; Key unlocks Trim; Trim retracts latch/Trim relocks when key is removed		
Lever (E) x 59 x Lever (N) x *59	Freewheeling Trim; Key unlocks Trim; Trim retracts latch/Trim relocks when key is removed		

MP9800A Electromechanical

Lever (E) x 01 x Lever (N) x *903	Blank Escutcheon Plate		
Lever (E) x 01 x Lever (N) x *905	Blank Escutcheon Plate		
Lever (E) x 40 x Lever (N) x *903	No outside Operation (No Cylinder); Pull Only		
Lever (E) x 40 x Lever (N) x *905	No outside Operation (No Cylinder); Pull Only		
Lever (E) x 49 x Lever (N) x *903	Key unlocks Trim; Trim retracts latch; Trim relocks when key is removed	\$2,633.00	\$2,703.00
Lever (E) x 49 x Lever (N) x *905	Key unlocks Trim; Trim retracts latch; Trim relocks when key is removed		
Lever (E) x 903 x Lever (N) x 10	Electrified Trim - Fail Safe		
Lever (E) x 903 x Lever (N) x *45	Electrified Trim - Fail Safe		
Lever (E) x 905 x Lever (N) x 10	Electrified Trim - Fail Secure		
Lever (E) x 905 x Lever (N) x *45	Electrified Trim - Fail Secure		
Lever (E) x 905 x Lever (N) x *903	Electrified Trim - Fail Secure		
Lever (E) x 905 x Lever (N) x *905	Electrified Trim - Fail Secure		
Lever (E) x 903 x Lever (N) x *903	Electrified Trim - Fail Safe	\$2,800.00	\$2,870.00
Lever (E) x 903 x Lever (N) x *905	Electrified Trim - Fail Safe		

* Not recommended for use on any door used for Life Safety egress.

MP9800 Series

Multi-Point Vertical Rod Lock



USA & Canada Prices Effective March 16, 2020

*Cylinder Options	Specify	Add or Deduct
Conventional 6-pin	6P	Add \$93.00 per cylinder
Conventional 7-pin	7P	Add \$95.00 per cylinder
Access 3 Patented	AP	Add \$93.00 per cylinder
Access 3 Security	AS	Add \$142.00 per cylinder
Access 3 High Security, UL 437	AHS	Add \$162.00 per cylinder
Access 3 IC Patented	ACP	Add \$173.00 per cylinder
Access 3 IC Security	ACS	Add \$222.00 per cylinder
Access 3 IC High Security, UL 437	ACHS	Add \$242.00 per cylinder
Pyramid Security fixed core	PS	Add \$157.00 per cylinder
Pyramid Security IC	PCS	Add \$233.00 per cylinder
Pyramid High Security fixed core	PHS	Add \$189.00 per cylinder
Pyramid High Security IC	PCHS	Add \$264.00 per cylinder
Pyramid IC with temporary construction core	CTP	Add \$173.00 per cylinder
Pyramid IC with temporary disposable core	CTPD	Add \$93.00 per cylinder
Pyramid IC less core	CLP	Add \$93.00 per cylinder
Security	HS	Add \$214.00 per cylinder
Security IC	CHS	Add \$292.00 per cylinder
IC 6-pin	C6	Add \$173.00 per cylinder
IC 6-pin with temporary construction core(Red)	CT6R	Add \$173.00 per cylinder
IC 6-pin with temporary construction core(Blue)	CT6B	Add \$173.00 per cylinder
IC 6-pin with temporary construction core(Green)	CT6G	Add \$173.00 per cylinder
IC 6-pin with temporary disposable core	CT6D	Add \$93.00 per cylinder
IC 6-pin less core	CL6	Add \$93.00 per cylinder
SFIC 6-pin with Less Core	CLS6	Add \$93.00 per cylinder
IC 6-pin with SFIC disposable temporary core	CT6SD	Add \$93.00 per cylinder
IC 7-pin	C7	Add \$177.00 per cylinder
IC 7-pin with temporary construction core(Red)	CT7R	Add \$177.00 per cylinder
IC 7-pin with temporary construction core(Blue)	CT7B	Add \$177.00 per cylinder
IC 7-pin with temporary construction core(Green)	CT7G	Add \$177.00 per cylinder
IC 7-pin with temporary disposable core	CT7D	Add \$95.00 per cylinder
IC 7-pin less core	CL7	Add \$95.00 per cylinder
SFIC 7-pin with Less Core	CLS7	Add \$95.00 per cylinder
IC 7-pin with SFIC disposable temporary core	CTS7SD	Add \$95.00 per cylinder
*Keying Options	Specify Quick Code	Add or Deduct
O-Bitted with 2 blank keys	STDKEY	No Charge
Keyed random	KR Specify Keyset	No Charge
Master keyed (all cylinders except 8000, 8020, 8027 IC core)	MK	Add \$16.00 per cylinder
Master keyed Pyramid	MK	Add \$16.00 per cylinder
Master keyed Security (including IC cylinder and core)	MK	Add \$16.00 per cylinder
Master keyed (8000, 8020, 8027 IC core)	MK-IC	No Charge
Master keyed to customer bittings or sample key	MK-CB	Add \$16.00 per cylinder
Construction master keyed	CMK	Add \$16.00 per cylinder
No Stamping	VKCO	\$4.50
Keys only	VKC1	No Charge
Cylinders and Keys	VKC2	\$8.00
Cylinders only	VKC3	\$8.00
CKC cylinders with VKC keys	CKC2	\$8.00
CKC cylinders only	CKC3	\$8.00

MP9800 Series
Multi-Point Vertical Rod Lock



USA & Canada Prices Effective March 16, 2020

Door Height Options	Specify	Add or Deduct
7'0"	Standard	No Charge
7'2"	H702	
7'6"	H706	
8'0"	H0800	
9'0"	H0900	
10'0"	H1000	
Door Thickness	Specify	Add or Deduct
1-3/4" (44mm)	Standard	No Charge
2" (51mm)	D200	No Charge
2-1/4" (57mm)	D214	No Charge
Motorized Electric Latch Retraction	Specify	Add or Deduct
Electric Latch Retraction	MELR	Add \$852.00 per device

MP9800 Series

Multi-Point Vertical Rod Lock



USA & Canada Prices Effective March 16, 2020

Miscellaneous Options	Specify	Add or Deduct
Spanner Head Screw	M02	Add \$36.00 per device per device
Torx® head screws	M04	Add \$48.00 per device per device
Knurling outside and inside	M20	Add \$153.00 per device per device
Knurling outside only	M21	Add \$72.00 per device per device
Knurling inside only	M22	Add \$81.00 per device per device
Abrasive coat outside and inside (trim and device)	M23	Add \$97.00 per device per device
Abrasive coat inside only (device side)	M24	Add \$51.00 per device per device
Abrasive coat outside only (trim side)	M25	Add \$46.00 per device per device
Less bottom vertical rod	M55	No Charge
Latchbolt Monitoring	M91	Add \$227.00 per device
O/S Lever Monitoring	M93	Add \$213.00 per device
I/S Lever Monitoring	M92	Add \$213.00 per device
Windstorm	M107	Add \$89.00 per device per device
Aluminum Door	MPAD	No Charge
Rectangular Back Plate (Required for Wood Door - MPWD)	MPER	
Back Plate (Required for Wood Door - MPWD)	MPES	
Lever Hold Back	MPHB	Add \$21.00 per device
Fire Rated Wood Door	MPWD	No Charge
aux control (classroom)	AUX155	Add \$657.00 per device
aux control (storeroom)	AUX159	Add \$657.00 per device
MicroShield® Antimicrobial finish coating	626C	Add \$69.00 (Exit Devices & Trims (ordered separately) Add \$86.00 (Exit Devices & Outside Trims (ordered together)
MicroShield® Antimicrobial finish coating	630C	Add \$69.00 (Exit Devices & Trims (ordered separately) Add \$86.00 (Exit Devices & Outside Trims (ordered together)

MicroShield® How to Order, Pricing	249
------------------------------------	-----

ED3000 Crossbar Series:

ED3000 Series Standard Features	250
ED3000 Series Ordering Examples	251
ED3000 Series: Rim ED3200	252
ED3000 Series: Surface Vertical Rod ED3400 Series, Mortise ED3600 Series	253
ED3000 Series Escutcheon Trim Designs: A33 Armstrong, C33 Citation, D33 Dirke, L33 Lustra	254
ED3000 Series Escutcheon Trim Designs: N33 Newport, PR33 Princeton, R33 Regis	255
ED3000 Series Escutcheon Trim Designs: T33 D Grip, T34 Round Grip, T35 Sectional Grip, Auxiliary Control/Inside Lever Assembly: 3357T Nightlatch	256
ED3000 Series Offset Pull Trim & Cylinder Options	257
ED3000 Series Keying Options	258
ED3000 Series Strike Options	259
ED3000 Series Miscellaneous, Door Width, Door Thickness, Door Height Options	260
ED3000 Series Mullions, Removable Mullions, Key Removable Mullions, Mullion Cylinder Options, Ordering Examples	261

ED4000 Narrow Stile Pushpad Series:

ED4000 Series How to Order	262
ED4000 Series Standard Features	263
ED4000 Series Ordering Example	264
ED4000 Series: ED4200S, ED4200, ED4400, ED4800	265

ED4000 Series Museo Pushpad Exit Devices:

ED4000 Series: Museo Levers with 800 Series Escutcheon: Georgia, Pablo, Jackson, Salvador, Josef Marc Levers	266
ED4000 Series: Museo Levers with 800 Series Escutcheon: Piet Levers	267

ED4000 Narrow Stile Pushpad Series:

ED4000 Series Escutcheon Trim Designs: A8 Armstrong, C8 Citation, D8 Dirke	268
ED4000 Series Escutcheon Trim Designs: E8 Essex, L8 Lustra, N8 Newport, R8 Regis	269
ED4000 Series Escutcheon Trim Designs: PR8 Princeton, G8 Global, F4 Plate, O8 Plate x Thumbturn	270
ED4000 Series Escutcheon Trim Designs: O14 Plate x Thumbturn, T14 Pull/Thumbpiece, P10 Pull, K1 Key Only	271
ED4000 Series Pull Trim & Accessories	272
ED4000 Series Cylinder & Keying Options	273
ED4000 Series Door Height Options for ED4400, ED4800 Series, Width, Thickness, Strike Options	274
ED4000 Series Miscellaneous Options, Removable Mullion	275

ED5000 Pushpad Series:

ED5000 Series How to Order	276
EDS000 Series Standard Features	277
ED5000 Series Ordering Examples	278
EDS000 Series: ED5200S, ED5200, ED5400, ED5600, ED5800, ED5000DB	279

ED5000 Series: Museo Levers with 900 Series Escutcheon:

ED5000 Series: Museo Georgia, Pablo, Jackson, Salvador, Marc Josef Levers with 900 Series Escutcheon	280
ED5000 Series: Museo Georges Levers with 900 Series Escutcheon	281
ED5000 Series: Museo Piet Levers with 900 Series Escutcheon	282

Continued on next page.

ED5000 Pushpad Series:

ED5000 Series Escutcheon Trim Designs: A9 Armstrong, C9 Citation, D9 Dirke	283
ED5000 Series Escutcheon Trim Designs: E9 Essex, L9 Lustra, N9 Newport, R9 Regis	284
ED5000 Series Escutcheon Trim Designs: PR9 Princeton, F9, G9, VT9	285
ED5000 Series Escutcheon Trim Designs: FR9 Frascati, M9 Merlot, Z9 Zinfandel	286
ED5000 Series Escutcheon Trim Designs: TH900 Pull/Thumbpiece, P9 Pull, K1 Key Only	287
ED5000 Series Escutcheon Trim Designs: A4M Armstrong, C9M Citation, D9M Dirke	288
ED5000 Series Escutcheon Trim Designs: E9M Essex, L9M Lustra, N9M Newport	289
ED5000 Series Escutcheon Trim Designs: R9M Regis, PR9M Princeton, F9, G9M	290
ED5000 Series Escutcheon Trim Designs: FR9M Frascati, M9M Merlot, Z9M Zinfandel	291
ED5000 Series Escutcheon Trim Designs: TH900, TH9M00 Pull/Thumbpiece, P9M Pull, VT9M, K1M Key Only	292
ED5000 Series Escutcheon Trim Designs: A4M Armstrong, C9M Citation, D9M Dirke, E9 Essex	293
ED5000 Series Escutcheon Trim Designs: L9 Lustra, N9 Newport, R9 Regis, PR9 Princeton	294
ED5000 Series Escutcheon Trim Designs: FR9 Frascati, M9 Merlot, Z9 Zinfandel	295
ED5000 Series Offset Pull Trim P12, P13, P14, Electrified Options, Delayed Egress Device, Retrofit MELR Kit:	296
ED5000 Series Electrified Accessories	297
ED5000 Series Cylinder & Keying Options	298
ED5000 Series Door Height, Door Width, Door Thickness, Strike Options	299
ED5000 Series Miscellaneous Options, Surface Bolt	300
ED5000 Series Mullions, Removable Mullions, Key Removable Mullions, Mullions Cylinder Options	301

ED7000 Narrow Stile Crossbar Series:

ED7000 Series Standard Features	302
ED7000 Series Ordering Example	303
ED7000 Series: ED7200, ED7400, ED7600, ED7800	304
ED7000 Series Pull Trim Designs: P4 D Grip Pull, P5 Round Grip Pull, P6 Pull, P7 Plate	305
ED7000 Series Escutcheon Trim Designs: C4 Citation, D4 Dirke, O3 D Grip Operator, O4 Round Grip Operator	306
ED7000 Series Escutcheon Trim Designs: C4M Citation, D4M Dirke, G6M Global	307
ED7000 Series Escutcheon Trim Designs: T11M D Grip, T12M Round Grip, O5 Operator, Offset Pull Trim: P12, P13, P14	308
ED7000 Series Cylinder & Keying Options	309
ED7000 Series Strike Options	310
ED7000 Series Door Width, Door Thickness, Door Height, Miscellaneous Options	311
ED7000 Series Mortise Lock Only, Removable Mullion Ordering Example	312

ED8000 Pushpad Series:

ED8000 Series Standard Features	313
ED8000 Series Ordering Example	314
ED8000 Series: Rim ED8200, Vertical Rod ED8400	315
ED8000 Series Rose Trim Designs: A6 Armstrong, N6 Newport, PR6 Princeton	316
ED8000 Series Rose Trim G10 Global, Flat Plate Trim F1 Flat Plate, Pull Trim Design P1 Z-Pull	317
ED8000 Series Pull Trim: P2 Offset Pull, P8 Wing Pull, KO Key Only, Offset Pull Trim: P12, P13, P14	318
ED8000 Series Cylinder Options	319
ED8000 Series Keying, Door Width, Door Thickness, Door Height Options	320
ED8000 Series Miscellaneous & Strike Options	321
ED8000 Series Alarm Kit, Mullions, Door Height Options, Mullions Cylinder Options	322



Look for the  *MicroShield* icon.

ED3000
ED4000
ED5000
ED7000

MicroShield®

As part of their promise to provide innovative solutions to their customers, certain ASSA ABLOY Group brands offer the MicroShield® technology, a silver-based antimicrobial coating designed to inhibit the growth of bacteria.

MicroShield® is a registered trademark of Yale Security Inc., an ASSA ABLOY Group company.

Product	Series	MicroShield® Coated Components
Exit Devices	ED4000 and ED5000 Series	Inside rail, push rail, head cover, end cap* Outside trim: levers/pull* and escutcheons
	ED3000 and ED7000 Series	Active/Inactive case covers, cross bar, arms Outside trim: levers/pull* and escutcheons

AVAILABLE FINISHES

- MicroShield® is available on 626 and 630. Other finishes available by Special Product Application Request Form only.
- Specify 626C (satin chrome plated) or 630C (satin stainless steel) when ordering.
- MicroShield® coating will be applied over 626 and 630 finishes. All components will match 626.

Note: MicroShield® coating will only be applied to "high touch" components.

HOW TO ORDER

Product	How to Order
Exit Devices & Outside Trims (ordered together)	ED5200 x C955ET x 630C x LHR
Exit Devices & Trims (ordered separately)	N955ET x 630C x RHR

Description	Add
Exit Devices & Outside Trims (ordered together)	Add \$82.00 (when ordered together)
Exit Devices & Trims (ordered separately)	Add \$69.00

Standard Features

Handing

Handed, specify hand

Door Thickness

1-3/4"

Backset

2-3/4"

Projection

5-3/4"; 4-1/2" depressed

Trim

Cylinder is not included.
See page 256 for
cylinder options.

Rim

ED3200
ED3200A

Panic
3 Hour Fire Rated

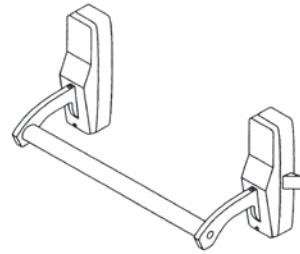

Surface Vertical Rod

ED3400 Panic
ED3400A 3 Hour Fire Rated

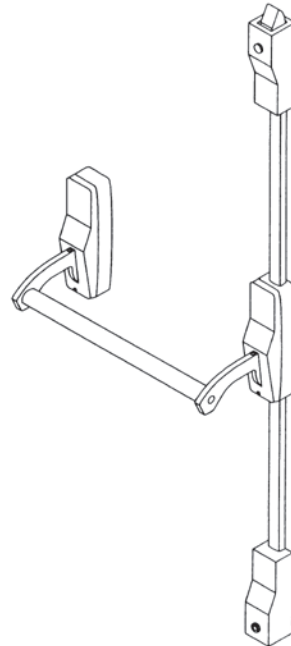

Mortise

ED3600 Panic
ED3600A 3 Hour Fire Rated

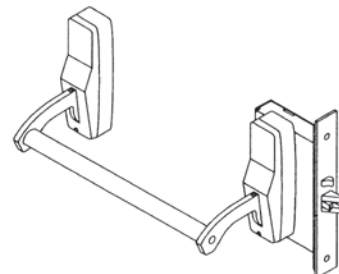

Ordering Examples
Rim Exit Device

Quantity	Exit Device	Finish	Hand	Misc. Options
20	ED3250	630	RHR	M51-M54

Rim Exit Device with Trim

Quantity	Exit Device	Trim	Finish	Hand	Door Thickness	Door Width	Misc. Options
50	ED3255A	A3355ET	630	RHR	D200	W048	M53

Trim Only (Rim Exit Device or Vertical Rod)

Quantity	Exit Device	Finish	Hand
10	L3310ET	606	RHR

Surface Vertical Rod Exit Device with Trim

Quantity	Exit Device	Trim	Finish	Hand	Door Thickness	Door Width	Misc. Options
50	ED3410	R3310ET	606	RHR	D214	W048	H1000

Mortise Exit Device with Trim

Quantity	Exit Device	Trim	Finish	Hand	Door Thickness	Strike	Door Width
50	ED3657	L3357ET	630	LHR	D200	SB200	W048

Contract/Detailed Order - Rim Exit Device with Trim

Quantity	Keypad	Exit Device	Trim	Finish	Hand	Door Thickness	Door Width	Optional Cylinders	Keying
50	AA1	ED3255	N3355ET	630	LHR	D200	W048	C6	VKC3

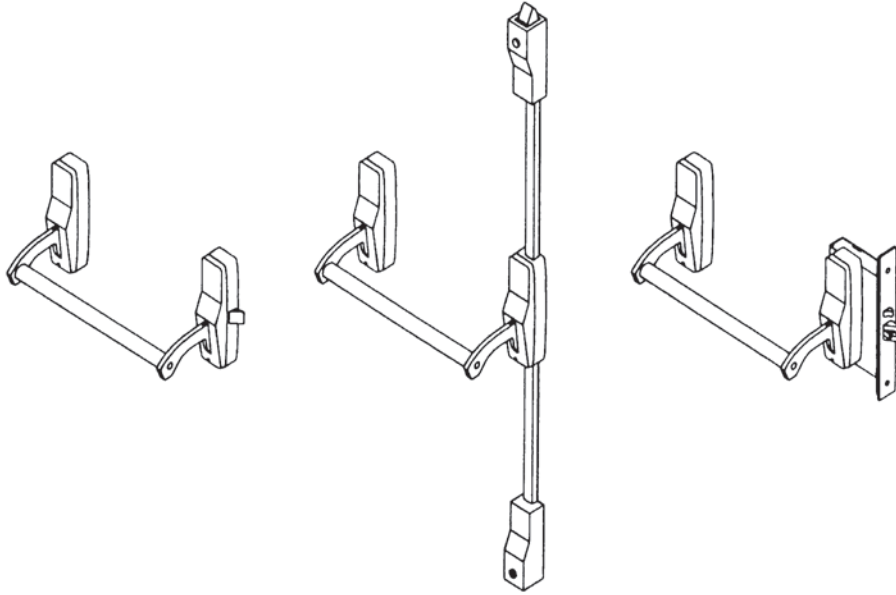

36" Device Only

Includes device, strike(s) and screw pack. No cylinder or trim.

Rim ED3200 Series

Function	Description	Finish: 613E	Finish: 605, 606, 611, 612, 613, 629, 630
ED3210	Panic device only (Passage)	\$1,996.00	\$2,166.00
ED3250	Panic device only (Dummy)		
ED3255	Panic (Classroom)		
ED3257	Panic (Nightlatch)		
ED3210T	Thumb Piece (Passage)		
ED3255T	Thumb Piece (Classroom)	\$2,166.00	\$2,336.00
ED3210A	3 Hour Fire Rated (Passage)		
ED3250A	3 Hour Fire Rated (Dummy)		
ED3255A	3 Hour Fire Rated (Classroom)		
ED3257A	3 Hour Fire Rated (Nightlatch)		
ED3210AT	Thumb Piece – 3 Hour Fire Rated (Passage)	\$2,166.00	\$2,336.00
ED3255AT	Thumb Piece – 3 Hour Fire Rated (Classroom)		

Caution: Be sure of your measurements. Exit devices are NOT returnable.

Notes:

For doors over 1-3/4" thick, a Special Application Request must be submitted to the factory prior to approval and pricing.

Surface Vertical Rod ED3400 Series

Function	Description	Finish: 613E	Finish: 605, 606, 611, 612, 613, 629, 630
ED3410	Panic (Passage)	\$2,501.00	\$2,671.00
ED3450	Panic (Dummy)		
ED3455	Panic (Classroom)		
ED3457	Panic (Nightlatch)		
ED3410T	Thumb Piece (Passage)		
ED3455T	Thumb Piece (Classroom)		
ED3410A	3 Hour fire rated (Passage)	\$2,671.00	\$2,841.00
ED3450A	3 Hour fire rated (Dummy)		
ED3455A	3 Hour Fire Rated (Classroom)		
ED3457A	3 Hour Fire Rated (Nightlatch)		
ED3410AT	Thumb Piece – 3 Hour Fire Rated (Passage)		
ED3455AT	Thumb Piece – 3 Hour Fire Rated (Classroom)		

Mortise ED3600 Series

Function	Description	Finish: 613E	Finish: 605, 606, 611, 612, 613, 629, 630
ED3610	Panic (Passage)	\$2,276.00	\$2,446.00
ED3650	Panic (Dummy)		
ED3655	Panic (Classroom)		
ED3657	Panic (Nightlatch)		
ED3610T	Thumb Piece (Passage)		
ED3655T	Thumb Piece (Classroom)		
ED3610A	3 Hour fire rated (Passage)		
ED3650A	3 Hour fire rated (Dummy)		
ED3655A	3 Hour Fire Rated (Classroom)		
ED3657A	3 Hour Fire Rated (Nightlatch)		
ED3610AT	Thumb Piece – 3 Hour Fire Rated (Passage)		
ED3655AT	Thumb Piece – 3 Hour Fire Rated (Classroom)		

Caution: Be sure of your measurements. Exit devices are NOT returnable.

Notes:

For doors over 1-3/4" thick, a Special Application Request must be submitted to the factory prior to approval and pricing.

ED3200/ED3200A/ED3400/ED3400A/ED3600/ED3600A Rim, Surface Vertical Rod, and Mortise Trim

Cylinder is not included.

Escutcheon Trim Design: A33 Armstrong



Lever: Cast **Escutcheon:** Cast

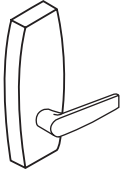

Function	Description	Finish: 605, 606, 611, 612, 613, 613E, 618, 619, 625, 626
A3310ET	Passage	\$598.00
A3350ET	Dummy	
A3355ET	Classroom	
A3357ET	Nightlatch – Rim	
A33V57ET	Nightlatch – SVR	
A33M57ET	Nightlatch – Mortise	

Escutcheon Trim Design: C33 Citation



Lever: Cast **Escutcheon:** Cast

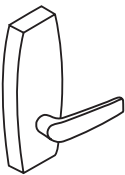

Function	Description	Finish: 605, 606, 611, 612, 613, 613E, 618, 619, 625, 626
C3310ET	Passage	\$598.00
C3350ET	Dummy	
C3355ET	Classroom	
C3357ET	Nightlatch – Rim	
C33V57ET	Nightlatch – SVR	
C33M57ET	Nightlatch – Mortise	

Escutcheon Trim Design: D33 Dirke



Lever: Cast **Escutcheon:** Cast

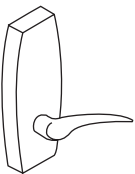

Function	Description	Finish: 605, 606, 611, 612, 613, 613E, 618, 619, 625, 626
D3310ET	Passage	\$598.00
D3350ET	Dummy	
D3355ET	Classroom	
D3357ET	Nightlatch – Rim	
D33V57ET	Nightlatch – SVR	
D33M57ET	Nightlatch – Mortise	

Escutcheon Trim Design: L33 Lustra



Lever: Cast **Escutcheon:** Cast

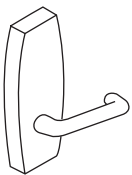

Function	Description	Finish: 605, 606, 611, 612, 613, 613E, 618, 619, 625, 626
L3310ET	Passage	\$598.00
L3350ET	Dummy	
L3355ET	Classroom	
L3357ET	Nightlatch – Rim	
L33V57ET	Nightlatch – SVR	
L33M57ET	Nightlatch – Mortise	

ED3200/ED3200A/ED3400/ED3400A/ED3600/ED3600A Rim, Surface Vertical Rod, and Mortise Trim

Cylinder is not included.

Escutcheon Trim Design: N33 Newport



Lever: Cast **Escutcheon:** Cast

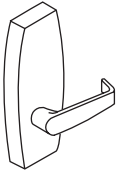

Function	Description	Finish: 605, 606, 611, 612, 613, 613E, 618, 619, 625, 626
N3310ET	Passage	\$598.00
N3350ET	Dummy	
N3355ET	Classroom	
N3357ET	Nightlatch – Rim	
N33V57ET	Nightlatch – SVR	
N33M57ET	Nightlatch – Mortise	

Escutcheon Trim Design: PR33 Princeton



Lever: Cast **Escutcheon:** Cast



Function	Description	Finish: 605, 606, 611, 612, 613, 613E, 618, 619, 625, 626
PR3310ET	Passage	\$598.00
PR3350ET	Dummy	
PR3355ET	Classroom	
PR3357ET	Nightlatch – Rim	
PR33V57ET	Nightlatch – SVR	
PR33M57ET	Nightlatch – Mortise	

Escutcheon Trim Design: R33 Regis



Lever: Cast **Escutcheon:** Cast

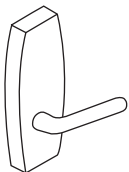

Function	Description	Finish: 605, 606, 611, 612, 613, 613E, 618, 619, 625, 626
R3310ET	Passage	\$598.00
R3350ET	Dummy	
R3355ET	Classroom	
R3357ET	Nightlatch – Rim	
R33V57ET	Nightlatch – SVR	
R33M57ET	Nightlatch – Mortise	

ED3200/ED3200A/ED3400/ED3400A/ED3600/ED3600A Rim, Surface Vertical Rod, and Mortise Trim

Cylinder is not included.

Escutcheon Trim Design: T33 D Grip

Grip: Extruded **Escutcheon:** Wrought



Function	Description	Finish: 605, 606, 611, 612, 613, 613E, 618, 619, 625, 626
T3310ET	Passage	\$391.00
T3350ET	Dummy	
T3355ET	Classroom	
T3357ET	Nightlatch – Rim	
T33M55ET	Classroom – Mortise	
T33M57ET	Nightlatch – Mortise	

Escutcheon Trim Design: T34 Round Grip

Grip: Extruded **Escutcheon:** Wrought



Function	Description	Finish: 605, 606, 611, 612, 613, 613E, 618, 619, 625, 626
T3410ET	Passage	\$391.00
T3450ET	Dummy	
T3455ET	Classroom	
T3457ET	Nightlatch – Rim	
T34M55ET	Classroom – Mortise	
T34M57ET	Nightlatch – Mortise	

Escutcheon Trim Design: T35 Sectional Grip

Grip: Extruded



Function	Description	Finish: 605, 606, 611, 612, 613, 613E, 618, 619, 625, 626
T3510ET	Passage	\$421.00
T3550ET	Dummy	
T3555ET	Classroom	
T3557ET	Nightlatch – Rim	
T35M55ET	Classroom – Mortise	
T35M57ET	Nightlatch – Mortise	

Auxiliary Control/Inside Lever Assembly: 3357T Nightlatch

Auxiliary Control



Function	Description	Finish: 605, 606, 611, 612, 613, 613E, 618, 619, 625, 626
3357T	Auxiliary Control/Inside Lever Assembly	\$772.00

Inside Lever Assembly



Offset Pull Trim: P12, P13, P14

Offset Pull Trim	Part Number	Finish: 605, 606, 612, 613, 613E, 626, 629, 630, BSP
P12	716F50M X Finish	\$304.00
P13	716F51M X Finish	\$370.00
P14	716F52M X Finish	\$261.00

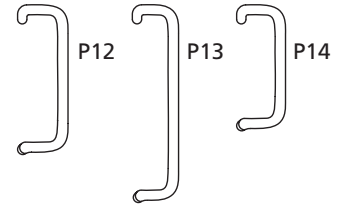
Cylinder Options

Description	Specify	Add or Deduct
Conventional 6-pin	6P*	Add \$93.00 per cylinder
Conventional 7-pin	7P	Add \$95.00 per cylinder
Access 3 Patented	AP	Add \$93.00 per cylinder
Access 3 Security	AS	Add \$142.00 per cylinder
Access 3 High Security, UL 437	AHS	Add \$162.00 per cylinder
Access 3 IC Patented	ACP	Add \$173.00 per cylinder
Access 3 IC Security	ACS	Add \$222.00 per cylinder
Access 3 IC High Security, UL 437	ACHS	Add \$242.00 per cylinder
Pyramid Security fixed core	PS	Add \$157.00 per cylinder
Pyramid Security IC	PCS	Add \$233.00 per cylinder
Pyramid High Security fixed core	PHS	Add \$189.00 per cylinder
Pyramid High Security IC	PCHS	Add \$264.00 per cylinder
Pyramid IC with temporary construction core	CTP	Add \$173.00 per cylinder
Pyramid IC with temporary disposable core	CTPD	Add \$93.00 per cylinder
Pyramid IC less core	CLP	Add \$93.00 per cylinder
Security	HS	Add \$214.00 per cylinder
Security IC	CHS	Add \$292.00 per cylinder
IC 6-pin	C6	Add \$173.00 per cylinder
IC 6-pin with temporary construction core (Red)	CT6R	Add \$173.00 per cylinder
IC 6-pin with temporary construction core (Blue)	CT6B	Add \$173.00 per cylinder
IC 6-pin with temporary construction core (Green)	CT6G	Add \$173.00 per cylinder
IC 6-pin with temporary disposable core	CT6D	Add \$93.00 per cylinder
IC 6-pin less core	CL6	Add \$93.00 per cylinder
SFIC 6-pin with Less Core	CLS6	Add \$93.00 per cylinder
IC 6-pin with SFIC disposable temporary core	CT6SD	Add \$93.00 per cylinder
IC 7-pin	C7**	Add \$177.00 per cylinder
IC 7-pin with temporary construction core (Red)	CT7R**	Add \$177.00 per cylinder
IC 7-pin with temporary construction core (Blue)	CT7B**	Add \$177.00 per cylinder
IC 7-pin with temporary construction core (Green)	CT7G**	Add \$177.00 per cylinder
IC 7-pin with temporary disposable core	CT7D**	Add \$95.00 per cylinder
IC 7-pin less core	CL7**	Add \$95.00 per cylinder
SFIC 7-pin with Less Core	CLS7**	Add \$95.00 per cylinder
IC 7-pin with SFIC disposable temporary core	CT7SD**	Add \$95.00 per cylinder

*6P cylinder option is supplied in 6-pin, L4 keyway 0-bitted with two nickel silver keys.
 IC 6-pin with temporary construction core CT6.
 IC 7-pin with temporary construction core CT7.
 **Not available with Rim or SVR Lever Trim – Classroom Function.
 or SVR Lever Trim – Night Latch Function.

Keying Options

Description	Specify	Add or Deduct
0-Bitted with 2 blank keys	(standard)	No Charge
Keyed random	KR	No Charge
Construction master keyed ^{1,2}	CMK	Add \$16.00 per cylinder
Visual key control (VKC)		
- No Stamping	VKC0	\$4.50
- Keys only	VKC1	No Charge
- Cylinders and Keys ³	VKC2	\$8.00
- Cylinders only ³	VKC3	\$8.00
Concealed key control (CKC)		
- CKC cylinders with VKC keys	CKC2	\$8.00
- CKC cylinders only ³	CKC3	\$8.00
More than 2 keys per lock	KY# (e.g., KY6)	See page 31 - Cut Keys Section

Notes:

1. CMK Construction master keying charge is in addition to master keying charge.
2. CMK Construction master keying is not available in interchangeable core, Access 3, Pyramid, or Security series.
3. VKC2, VKC3, CKC3 are not available in Pyramid or Security series.

Custom Laser Engraving- LASER
Laser engraving processing charge (all engraving types)

- \$250 net per order. Charge will be applied to production order when placed.

Single Vanity, Logo or Other (same engraving on all parts)

- Lever - \$10 net add each
- Mortise Escutcheon - \$10 net add each
- HPSK Paddle - \$10 net add each

Unique laser engraving (i.e. Room Number, Apartment Number, etc)

- \$12 net add each (per piece)

Strike Options

To purchase strike separately see catalog for part no.

Description	Specify Quick Code	Add or Deduct
Fire rated rim strike on ED3200	(standard)	No Charge
Mortised adjustable rim strike	S04	
Rim x vertical rod strike for pairs of doors	S02	Add \$26.00 to device
Vertical rod flush bottom strike (ED3400 only)	S03	No Charge
Vertical rod surface projecting bottom strike on ED3400 device	(standard)	
Fire rated vertical rod bottom strike on ED3400A device	(standard)	
Fire rated vertical rod bottom strike for threshold	S06	

Description	Door Thickness	Specify	Add or Deduct
Curved lip ANSI strike	1-3/4"	SA114 (standard)	No Charge
	2"	SA138	
	2-1/4"	SA158	

Description	Door Thickness	Specify	Add or Deduct
Mortise straight lip ANSI strike on ED3600, ED3600A	1-3/4"	SS118	No Charge
	2"	SS138	
	2-1/4"	SS158	

Description	Door Thickness	Specify	Add or Deduct
Mortise open back strike	1-3/4"	SB134	Add \$87.00 per device
	2"	SB200	\$140.00
	2-1/4"	SB214	\$140.00

Miscellaneous Options

Description	Specify	Add or Deduct
Spanner head screws	M02	Add \$36.00 per device
Torx® screws for rim, mortise	M04	Add \$48.00 per device
Torx® screws for surface vertical rod		Add \$90.00 per device
Abrasive coat outside and inside (trim and device)	M23	Add \$92.00 per device
Abrasive coat inside only (device side)	M24	Add \$48.00 per device
Abrasive coat outside only (trim side)	M25	Add \$44.00 per device
Steel reinforced crossbar	M53	Add \$68.00 per device
Sex nuts and bolts (SNBs)	M54	No Charge
Mullion stabilizer	M57	Add \$62.00 per mullion
Shim for 2-3/4" backset on doors with 1/2" stop (rim devices only)	M59	No Charge
Flush transom bracket	M67	Add \$30.00 per device

Door Width Options

Description	Specify	Add or Deduct
36"	(standard)	No Charge
48"	W048	Add \$35.00 per device

Door Thickness Options

Description	Specify	Add or Deduct
1-3/4"	(standard)	No Charge
2"	D200	
2-1/4"	D214	

Door Height Options

Description	Specify	Add or Deduct
7'0" H0700	H0700	No Charge
7'2" H0702	H0702	
7'6" H0706	H0706	
8' (Standard)	(standard)	Add \$87.00 per device
8'6" H0806 (ED3400 device only)	H0806	
9' H0900 (ED3400 device only)	H0900	
10' H01000 (ED3400 device only)	H1000	

Mullions

Cylinder not included

Ordering Example

Quantity	Mullion Number
10	507

Removable Mullion

Description	Specify	Price
Up to 7'0" Steel Mullion - Panic Rated	CR907	\$725.00
Up to 8'0" Steel Mullion - Panic Rated	CR908	\$735.00
Up to 10'0" (ED3200 only), Steel Mullion - Panic Rated	CR910	\$875.00
Up to 7'0", Steel Mullion - 3 Hour Fire Rated	CR907A	\$1,008.00
Up to 8'0", Steel Mullion - 3 Hour Fire Rated	CR908A	\$1,018.00

Key Removable Mullion

Description	Specify	Price
Up to 7'0", key removable mullion, 1-1/2 Hour Fire Rated	CR907BKM ¹	\$1,552.00
Up to 8'0", key removable mullion, 1-1/2 Hour Fire Rated	CR908BKM ¹	\$1,562.00
Up to 10'0" (ED3200 only), key removable mullion, Panic Rated	CR910KM ¹	\$1,372.00
Door frame filler block for double rabbeted frames	M95	Add \$42.00 per mullion
Door frame angle bracket for aluminum frames	M96	Add \$42.00 per mullion

Note 1: Cylinder and collars not included, specify separately

Mullions Cylinder Options

Description	Specify	Add or Deduct
Conventional 6-pin	6P	Add \$93.00 per cylinder
Conventional 7-pin	7P	Add \$95.00 per cylinder
IC 6-pin	C6	Add \$173.00 per cylinder
IC 7-pin	C7	Add \$177.00 per cylinder
Pyramid High Security Fixed Core	PHS	Add \$189.00 per cylinder
Pyramid Security Fixed Core	PS	Add \$157.00 per cylinder
Pyramid High Security IC	PCHS	Add \$264.00 per cylinder
Pyramid Security IC	PCS	Add \$233.00 per cylinder
Security	HS	Add \$214.00 per cylinder
Security IC	CHS	Add \$292.00 per cylinder
IC 6-pin with temporary construction core (Red)	CT6R	Add \$173.00 per cylinder
IC 6-pin with temporary construction core (Blue)	CT6B	Add \$173.00 per cylinder
IC 6-pin with temporary construction core (Green)	CT6G	Add \$173.00 per cylinder
IC 6-pin with temporary disposable core	CT6D	Add \$93.00 per cylinder
IC 6-pin less core	CL6	Add \$93.00 per cylinder
IC 7-pin	C7**	Add \$177.00 per cylinder
IC 7-pin with temporary construction core (Red)	CT7R**	Add \$177.00 per cylinder
IC 7-pin with temporary construction core (Blue)	CT7B**	Add \$177.00 per cylinder
IC 7-pin with temporary construction core (Green)	CT7G**	Add \$177.00 per cylinder
IC 7-pin with temporary disposable core	CT7D**	Add \$95.00 per cylinder

IC 7-pin with temporary construction core CT7. **Not available with Rim or SVR Lever Trim – Classroom Function. or SVR Lever Trim – Night Latch Function.

Mortise Lock Only

Lock Number	Description	Finish: 605, 606, 611, 612, 613, 613E, 625, 626
MLE012	Lockbody for Nightlatch/Dummy function	\$671.00
MLE013	Lockbody for Classroom function	
MLE014	Lockbody for Passage function	
MLE015	Lockbody for Passage Thumbpiece function	
MLE016	Lockbody for Classroom Thumbpiece function	

Ordering Example
Mortise Lock Only

Quantity	Lock Number	Finish	Hand
2	MLE013	630	LHR

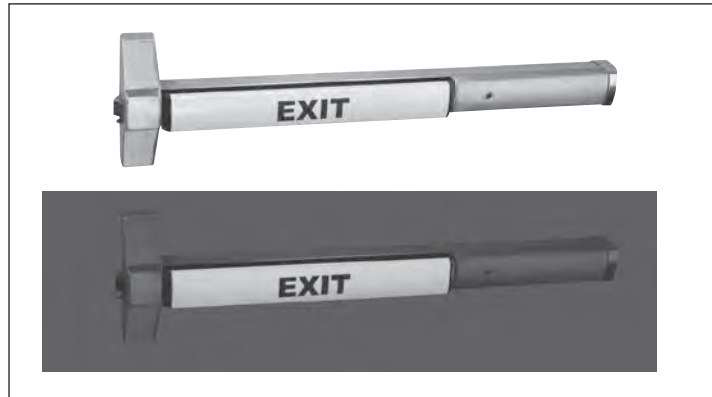

The PathLite™ patent pending technology offers a number of benefits:

- Requires no wiring or maintenance
- Recharges with exposure to ambient light
- Unaffected by heat or cold
- Non-toxic, will not rub or fade
- Vandal resistant
- Fire resistant and non-radioactive
- Green contrasting word "EXIT" centered on touchbar in 1-1/4" high lettering
- Cost effective; especially suited for existing buildings

PathLite™ photoluminescent exit devices meet New York City's newly adopted standards for requirement of photoluminescent signage and stairwell markings in all office buildings in excess of 75 feet in height.

How To Order Complete Device

Exit Device	Trim/Function	Finish	Hand	Misc. Options
ED4200	A810	630	RHR	M49

ED4200 x A810 x 630 x RHR x M49

Options	Specify	Price
24", 36" , and 48" PathLite™ Photoluminescent Touchbar Cover	M49	Add: \$348.00

How to Order Touchbar Cover Only

Options	Part Number	Price
24" PathLite™ Photoluminescent Touchbar cover	710F797	\$374.00
36" PathLite™ Photoluminescent Touchbar cover	710F737	
48" PathLite™ Photoluminescent Touchbar cover	710F747	

**Standard Features
Handing**

Devices are field reversible;
specify hand. Lever trims are
handed; specify hand

Door Thickness

1-3/4"

Product	Minimum Stile
ED4200S	2"
ED4200SM	3 1/2"
ED4200SMA	3 1/2"
ED4200	2"
ED4200M	3 1/2"
ED4200MA	3 1/2"
ED4400	2"
ED4400M	3 1/2"
ED4400MA	3 1/2"
ED4800	2"
ED4800M	3 1/2"
ED4800MA	3 1/2"

Projection

3-1/4"; 2-3/4" dogged

Trim

Cylinder is not included.
See page 270 for
cylinder options

Door Width

36"

SecureBolt®

ED4200S Panic
ED4200SM Panic
ED4200SMA 3 Hour Fire
Rated

Rim

ED4200 Panic
ED4200M Panic
ED4200MA 3 Hour Fire Rated

Surface Vertical Rod

ED4400 Panic
ED4400M Panic
ED4400MA 3 Hour Fire Rated

Concealed Vertical Rod

ED4800 Panic
ED4800M Panic
ED4800MA 3 Hour Fire Rated

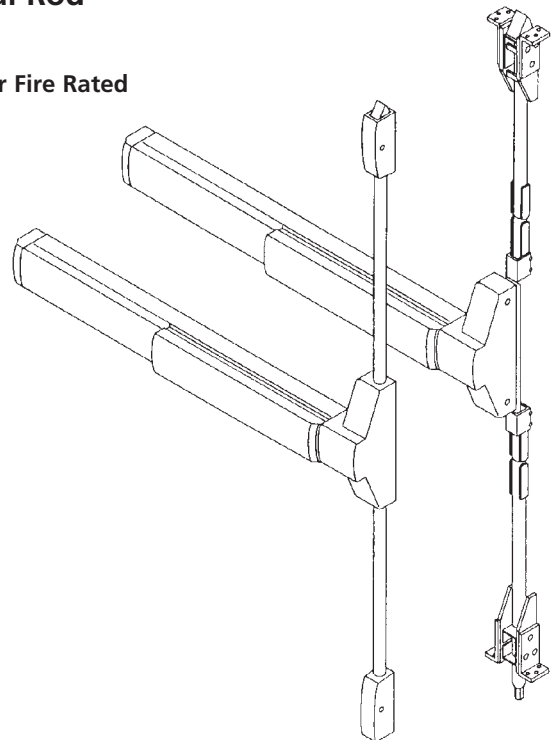
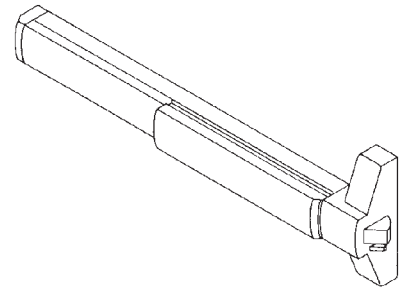

Ordering Example

Exit Device Only

Quantity	Exit Device	Finish	Hand	Misc. Options
20	ED4200	606	RHR	M51-M54

Removable Mullions

Quantity	Mullion	Finish	Misc. Options
12	CR808	695	M57

Exit Device with Trim

Quantity	Exit Device	Trim/Function	Finish	Hand	Door Thickness	Door Width	Door Height	Misc. Options
10	ED4400	N855ET	605	LHR	D200	W048	H0706	M51-M54

Trim Only

Quantity	Trim/Function	Finish	Hand	Door Thickness
24	N855ET	625	RHR	D214

Contract/Detailed Order - Rim Exit Device with Trim

Quantity	Keypad	Exit Device	Trim/Function	Finish	Hand	Door Height	Optional Strike	Door Width	Misc. Options	Optional Cylinder
36	AA1	ED4400	C855ET	626	LHR	H0800	S09	W048	M52-M54	7P

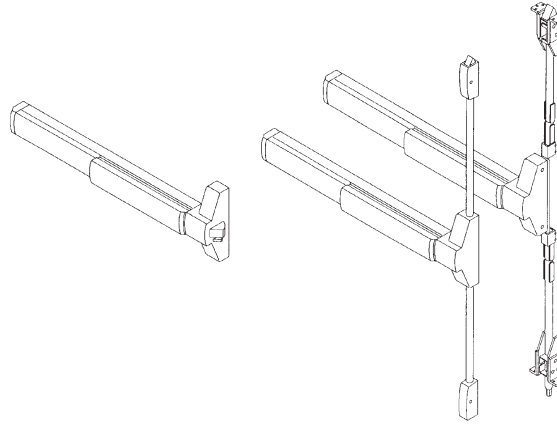

36" Device Only, See Quick Code section for 24" and 48" door width options

Includes device, strike(s) and screw pack. No cylinder or trim.

SecureBolt® ED4200S Series

Function	Description	Finish: 613E, 630, BSP, WSP	Finish: 605, 606, 611, 612, 613, 618, 619, 625, 629, 722
ED4200S	Panic	\$2,211.00	\$2,291.00
ED4200SM	Panic	\$2,211.00	\$2,291.00
ED4200SMA	3 Hour Fire Rated	\$2,381.00	\$2,461.00

Rim ED4200 Series

Function	Description	Finish: 613E, 630, BSP, WSP	Finish: 605, 606, 611, 612, 613, 618, 619, 625, 629, 722
ED4200	Panic	\$2,143.00	\$2,223.00
ED4200M	Panic	\$2,143.00	\$2,223.00
ED4200MA	3 Hour Fire Rated	\$2,313.00	\$2,393.00

Vertical Rod ED4400 Series

Function	Description	Finish: 613E, 630, BSP, WSP	Finish: 605, 606, 611, 612, 613, 618, 619, 625, 629, 722
ED4400	Panic	\$2,453.00	\$2,533.00
ED4400M	Panic	\$2,453.00	\$2,533.00
ED4400MA	3 Hour Fire Rated	\$2,623.00	\$2,703.00

Concealed V.R. ED4800 Series

Function	Description	Finish: 613E, 630, BSP, WSP	Finish: 605, 606, 611, 612, 613, 618, 619, 625, 629, 722
ED4800	Panic	\$2,714.00	\$2,794.00
ED4800M	Panic	\$2,714.00	\$2,794.00
ED4800MA	3 Hour Fire Rated	\$2,884.00	\$2,964.00

Caution: Be sure of your measurements. Exit devices are NOT returnable.

Pushpad Exit Devices

ED4000 Series: Muséo Levers with 800 Series Escutcheon

USA & Canada Prices Effective March 16, 2020



contemporary levers to complement the interior design of your next project

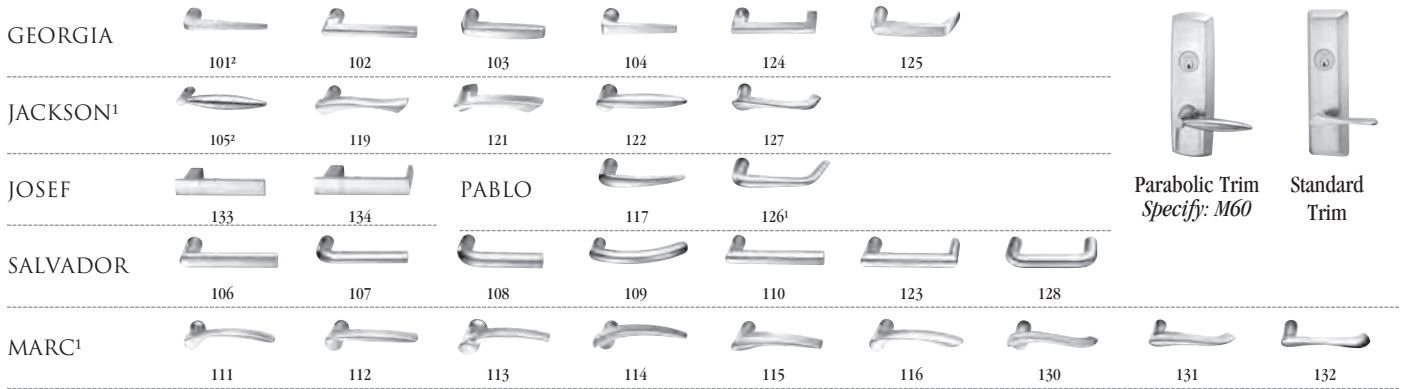

1. Handed: specify hand when ordering
2. Contact factory for current lead time

*629 and *630 finish options are Not available for all Muséo levers. Please refer to page 20 for availability.

605	Bright Brass, Clear Coated	613L	Dark Oxidized Satin Bronze, Clear Coated	WSP	White Suede Powder Coat
606	Satin Brass, Clear Coated	618	Bright Nickel Plated	722	Black Oxidized Bronze, Oil Rubbed
611	Bright Bronze, Clear Coated	619	Satin Nickel Plated		
612	Satin Bronze, Clear Coated	625	Bright Chromium Plated		
613	Dark Oxidized Satin Bronze, Oil Rubbed	629*	Bright Stainless Steel		
613E	Dark Oxidized Satin Bronze - Equivalent	630*	Satin Stainless Steel		
		BSP	Black Suede Powder Coat		

Function

Rim/SVR/CVR	810 850 855 859	Passage Dummy Nightlatch	\$733.00
Options	M60	Parabolic Escutcheon	Add \$82.00 per device

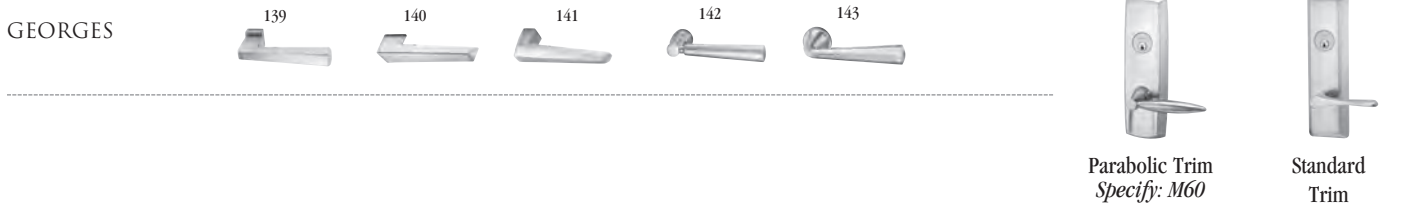

1. Handed: specify hand when ordering
2. Contact factory for current lead time

605	Bright Brass, Clear Coated	613L	Dark Oxidized Satin Bronze, Clear Coated	WSP	White Suede Powder Coat
606	Satin Brass, Clear Coated	618	Bright Nickel Plated	722	Black Oxidized Bronze, Oil Rubbed
611	Bright Bronze, Clear Coated	619	Satin Nickel Plated		
612	Satin Bronze, Clear Coated	625	Bright Chromium Plated		
613	Dark Oxidized Satin Bronze, Oil Rubbed	629*	Bright Stainless Steel		
613E	Dark Oxidized Satin Bronze - Equivalent	630*	Satin Stainless Steel		
		BSP	Black Suede Powder Coat		

Rim/SVR/CVR	810 850	Passage Dummy Nightlatch	\$753.00
Options	M60	Parabolic Escutcheon	Add \$82.00 per device



Experience a safer and more open world

Pushpad Exit Devices

ED4000 Series: Muséo Levers with 800 Series Escutcheon

USA & Canada Prices Effective March 16, 2020

contemporary levers to complement the interior design of your next project



PIET



*613E, BSP, WSP finishes are not available with 21M levers.



Parabolic Trim Standard Trim
Specify: M60

613E	Dark Oxidized Satin Bronze – Equivalent
629	Bright Stainless Steel
630	Satin Stainless Steel
BSP	Black Suede Powder Coat
WSP	White Suede Powder Coat

Function

Rim/SVR/CVR	810 850 855 859	Passage Dummy Nightlatch		\$753.00
Options	M60	Parabolic Escutcheon		Add \$82.00 per device



Experience a safer
and more open world

ED4200S/ED4200/ED4400/ED4800 SecureBolt® , Rim, Surface and Concealed V.R. Trim

Cylinder is not included.

Escutcheon Trim Design: A8 Armstrong



Lever: Cast

Escutcheon: Wrought

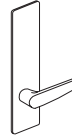

Function	Description	Finish: 605, 606, 611, 612, 613, 613E, 618, 619, 625, 626, 629, 630, 722, BSP
A810ET	Passage	\$681.00
A850ET	Dummy	
A855ET	Classroom ¹	
A859ET	Storeroom	

Escutcheon Trim Design: C8 Citation



Lever: Cast

Escutcheon: Wrought

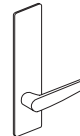

Function	Description	Finish: 605, 606, 611, 612, 613, 613E, 618, 619, 625, 626, 629, 630, 722, BSP
C810ET	Passage	\$681.00
C850ET	Dummy	
C855ET	Classroom ¹	
C859ET	Storeroom	

Escutcheon Trim Design: D8 Dirke



Lever: Cast

Escutcheon: Wrought

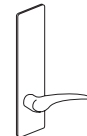

Function	Description	Finish: 605, 606, 611, 612, 613, 613E, 618, 619, 625, 626, 629, 630, 722, BSP
D810ET	Passage	\$681.00
D850ET	Dummy	
D855ET	Classroom ¹	
D859ET	Storeroom	

Note:

1. Classroom function trim may be converted to storeroom function by a simple field adjustment. No additional parts required.

ED4200S/ED4200/ED4400/ED4800 SecureBolt®, Rim, Surface and Concealed V.R. Trim

Cylinder is not included.

Escutcheon Trim Design: E8 Essex



Lever: Cast

Escutcheon: Wrought

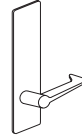

Function	Description	Finish: 605, 606, 611, 612, 613, 613E, 618, 619, 625, 626, 629, 630, 722, BSP
E810ET	Passage	\$681.00
E850ET	Dummy	
E855ET	Classroom ¹	
E859ET	Storeroom	

Escutcheon Trim Design: L8 Lustra



Lever: Cast

Escutcheon: Wrought

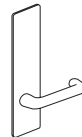

Function	Description	Finish: 605, 606, 611, 612, 613, 613E, 618, 619, 625, 626, 629, 630, 722, BSP
L810ET	Passage	\$681.00
L850ET	Dummy	
L855ET	Classroom ¹	
L859ET	Storeroom	

Escutcheon Trim Design: N8 Newport



Lever: Cast

Escutcheon: Wrought

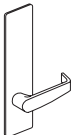

Function	Description	Finish: 605, 606, 611, 612, 613, 613E, 618, 619, 625, 626, 629, 630, 722, BSP
N810ET	Passage	\$681.00
N850ET	Dummy	
N855ET	Classroom ¹	
N859ET	Storeroom	

Escutcheon Trim Design: R8 Regis



Lever: Cast

Escutcheon: Wrought

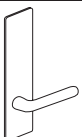

Function	Description	Finish: 605, 606, 611, 612, 613, 613E, 618, 619, 625, 626, 629, 630, 722, BSP
R810ET	Passage	\$681.00
R850ET	Dummy	
R855ET	Classroom ¹	
R859ET	Storeroom	

Note: 1. Classroom function trim may be converted to storeroom function by a simple field adjustment. No additional parts required.

ED4200S/ED4200/ED4400/ED4800 SecureBolt® , Rim, Surface and Concealed V.R. Trim

Cylinder is not included.

Escutcheon Trim Design: PR8 Princeton



Lever: Cast

Escutcheon: Wrought



Function	Description	Finish: 605, 606, 611, 612, 613, 613E, 618, 619, 625, 626, 629, 630, 722, BSP
PR810ET	Passage	\$681.00
PR850ET	Dummy	
PR855ET	Classroom ¹	
PR859ET	Storeroom	

Escutcheon Trim Design: G8 Global

Knob: Wrought

Escutcheon: Wrought



Function	Description	Finish: 605, 606, 611, 612, 613, 613E, 618, 619, 625, 626, 629, 630, 722, BSP
G810ET	Passage	\$633.00
G850ET	Dummy	
G855ET	Classroom ¹	
G859ET	Storeroom	

Escutcheon Trim Design: F4 Plate

Plate: Wrought



Function	Description	Finish: 605, 606, 611, 612, 613, 613E, 618, 619, 625, 626, 629, 630, 722, BSP
F450ET	Dummy	\$270.00
F457ET	Nightlatch	

Escutcheon Trim Design: O8 Plate x Thumbturn

Plate: Wrought

Thumbturn: Cast



Function	Description	Finish: 605, 606, 612, 613, 613E, 630, 722, BSP
O810	Passage	\$552.00
O855 ¹	Classroom	
O859	Storeroom	

Note:

1. Classroom function trim may be converted to storeroom function by a simple field adjustment. No additional parts required.

ED4200S/ED4200/ED4400/ED4800 SecureBolt®, Rim, Surface and Concealed V.R. Trim

Cylinder is not included.

Escutcheon Trim Design: O14 Plate x Thumbturn

Pull: Cast **Escutcheon:** Wrought **Thumbturn:** Cast



Function	Description	Finish: 605, 606, 611, 612, 613, 613E, 618, 619, 625, 626, 629, 630, 722, BSP
O1410ET	Passage	\$673.00
O1455ET ¹	Classroom	
O1459ET	Storeroom	

Escutcheon Trim Design: T14 Pull/Thumbpiece

Grip: Cast **Escutcheon:** Wrought



Function	Description	Finish: 605, 606, 611, 612, 613, 613E, 618, 619, 625, 626, 629, 630, 722, BSP
T1410ET	Passage	\$650.00
T1450ET	Dummy	\$580.00
T1455ET ¹	Classroom	\$650.00
T1457ET	Nightlatch (see note 2)	\$580.00

Escutcheon Trim Design: P10 Pull



Pull: Extruded **Escutcheon:** Wrought



Function	Description	Finish: 605, 606, 611, 612, 613, 613E, 618, 619, 625, 626, 629, 630, 722, BSP
P1050ET	Dummy	\$655.00
P1057ET	Nightlatch (see note 2)	

Escutcheon Trim Design: K1 Key Only

Note: Available with cylinder option only. Example: K157 x 6P



Function	Description	Finish: 605, 606, 611, 612, 613, 618, 619, 622, 625, 626, 722
K157ET	Nightlatch ²	\$62.00

Notes:

- Classroom function trim may be converted to storeroom function by a simple field adjustment. No additional parts required.
- Not recommended for use on surface or concealed vertical rod exit devices.

Offset Pull Trim: P12, P13, P14

Offset Pull Trim	Part Number	Finish: 605, 606, 611, 612, 613, 613E, 618, 619, 625, 626, 629, 630, 722, BSP	
P12	716F50M X Finish		\$304.00
P13	716F51M X Finish		\$370.00
P14	716F52M X Finish		\$261.00

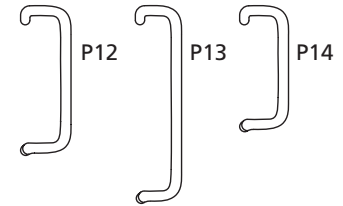

Electrified Options for Exit Devices

Description	Specify	Add or Deduct
Exit Alarm Device (cylinder is not included)	M61	\$770.00
Bolt Position Monitoring	M91*	Add \$227.00
Touchbar Monitoring or Signaling/Request to Exit (REX)	M92*	Add \$213.00
Outside Trim Monitoring or Signaling	M93*	
Motor Latch Retraction	MELR	Add \$852.00
Electric Dogging	M97	Add \$435.00

Delayed Egress Device

Description	Specify	Add or Deduct
Delayed Egress (Suffix the letter D to device. Ex: ED4200)	D	Add \$1672.00
30-Second Delay	M88*	\$116.00
BOCA 15-Second Delay	M89*	
BOCA 30-Second Delay	M90*	

Electrified Accessories

Part Number	Description	Specify	Price
709F609	Power Supply 1 Amp (controls 1 'D' device)	BPS-24-1	\$355.00
709F619	Power Supply 2 Amp (controls 2 'D' devices or 1 "D" with SAF or SEC)	BPS-24-2	\$722.00
709F269	Power Supply 4 amp 24VDC	BPS-24-4	\$1,220.00
704F288	Concealed transfer (for over 120-degree swing door)	EPTL	\$140.00
709F689	(1) SPDT Maintained Switch (Includes LED)	MKA	\$140.00
709F709	(1) SPDT Momentary Switch (Includes LED)	MK	\$214.00
709F749	(1) SPDT Momentary Switch (Illuminated)	PB2	\$164.00
709F759	(1) SPDT Maintained (Alternating Action) Switch	PB3EA	\$125.00
709F769	(1) SPDT Momentary Switch (Illuminated)	PB3	\$159.00
709F779	(1) SPDT Momentary Switch	PB3ER	\$106.00
709F729	DPDT Momentary Key Switch	MK2	\$246.00
709F699	Narrow Stile Key Switch (Alt. action)	MKAN	\$214.00
709F719	Narrow Stile Momentary Key Switch	MKN	\$214.00
709F789	Sonalert 90db @ 2 ft. 12-24VDC. Mounted on one gang stainless steel plate.	PZ1	\$106.00
	Alarm Kit (cylinder is not included)¹	ED40AK	\$875.00
709F679	Door Cord	TSB-C	\$45.00
741F739	Digital Entry System (4 users)	DK-12	\$39.00
709F809	Digital Entry System (59 users) ST finish	FADK-26SS	\$753.00
709F819	Digital Entry System (59 users) Black finish	DK-26BK	\$753.00

Notes:

1. Alarm kit cannot be installed in the field to surface vertical rod exit device. Any attempt to do so voids all warranties.

***ElectroLynx®**

As part of their promise to provide innovative, fast and effective high security solutions to their customers, certain ASSA ABLOY Group brands offer *ElectroLynx®*, a universal quick-connect system that simplifies the electrification of the door opening.

Cylinder Options*

Description	Specify	Add or Deduct
Conventional 6-pin	6P**	Add \$93.00 per cylinder
Conventional 7-pin	7P	Add \$95.00 per cylinder
Access 3 Patented	AP	Add \$93.00 per cylinder
Access 3 Security	AS	Add \$142.00 per cylinder
Access 3 High Security, UL 437	AHS	Add \$162.00 per cylinder
Access 3 IC Patented	ACP	Add \$173.00 per cylinder
Access 3 IC Security	ACS	Add \$222.00 per cylinder
Access 3 IC High Security, UL 437	ACHS	Add \$242.00 per cylinder
Pyramid Security fixed core	PS	Add \$157.00 per cylinder
Pyramid Security IC	PCS	Add \$233.00 per cylinder
Pyramid High Security fixed core	PHS	Add \$189.00 per cylinder
Pyramid High Security IC	PCHS	Add \$264.00 per cylinder
Pyramid IC with temporary construction core	CTP	Add \$173.00 per cylinder
Pyramid IC with temporary disposable core	CTPD	Add \$93.00 per cylinder
Pyramid IC less core	CLP	Add \$93.00 per cylinder
Security	HS	Add \$214.00 per cylinder
Security IC	CHS	Add \$292.00 per cylinder
IC 6-pin	C6	Add \$173.00 per cylinder
IC 6-pin with temporary construction core (Red)	CT6R	Add \$173.00 per cylinder
IC 6-pin with temporary construction core (Blue)	CT6B	Add \$173.00 per cylinder
IC 6-pin with temporary construction core (Green)	CT6G	Add \$173.00 per cylinder
IC 6-pin with temporary disposable core	CT6D	Add \$93.00 per cylinder
IC 6-pin less core	CL6	Add \$93.00 per cylinder
SFIC 6-pin with Less Core	CLS6	Add \$93.00 per cylinder
IC 6-pin with SFIC disposable temporary core	CT6SD	Add \$93.00 per cylinder
IC 7-pin	C7	Add \$177.00 per cylinder
IC 7-pin with temporary construction core (Red)	CT7R	Add \$177.00 per cylinder
IC 7-pin with temporary construction core (Blue)	CT7B	Add \$177.00 per cylinder
IC 7-pin with temporary construction core (Green)	CT7G	Add \$177.00 per cylinder
IC 7-pin with temporary disposable core	CT7D	Add \$95.00 per cylinder
IC 7-pin less core	CL7	Add \$95.00 per cylinder
SFIC 7-pin with Less Core	CLS7	Add \$95.00 per cylinder
IC 7-pin with SFIC disposable temporary core	CT7SD	Add \$95.00 per cylinder

*Optional dogging cylinder will be furnished with the same mechanism and keyed alike with the trim cylinder, unless otherwise specified. If different keying or cylinder type is required, specify outside (trim) first, then inside (dogging) cylinder.

**6P cylinder option is supplied in 6-pin, L4 keyway, 0-bitted with two nickel silver keys.

Keying Options*

Description	Specify	Add or Deduct
0-Bitted with 2 blank keys	(standard)	No Charge
Keyed random	KR	No Charge
Master keyed (all cylinders except 8000, 8020, 8027 IC)	specify keyset	Add \$16.00 per cylinder
Master keyed Pyramid	specify keyset	Add \$16.00 per cylinder
Master keyed Security (including IC cylinder and core)	specify keyset	Add \$16.00 per cylinder
Master keyed (8000, 8020, 8027 IC core)	specify keyset	No Charge
Master keyed to customer bittings or sample key	specify keyset	Add \$16.00 per cylinder
Construction master keyed ^{1, 2}	CMK	Add \$16.00 per cylinder
Visual key control (VKC)		
- No Stamping	VKC0	\$4.50
- Keys only	VKC1	No Charge
- Cylinders and Keys ³	VKC2	\$8.00
- Cylinders only ³	VKC3	\$8.00
Concealed key control (CKC)		
- CKC cylinders with VKC keys	CKC2	\$8.00
- CKC cylinders only ³	CKC3	\$8.00
More than 2 keys per lock	KY# (e.g., KY6)	See page 31 - Cut Keys Section

*For key bows other than 10 and 90, specify "KB" + bow number as Quick Code, e.g. KB12.

Notes:

1. CMK Construction master keying charge is in addition to master keying charge.

2. CMK Construction master keying is not available in interchangeable core, Access 3, Pyramid, or Security series.

3. VKC2, VKC3, CKC3 are not available in Pyramid or Security series.

Door Height Options
ED4400 Device

Door Height	Specify	Add or Deduct
7'0"	(standard)	No Charge
7'2"	H0702	
7'6"	H0706	
8'0"	H0800	
9'0"	H0900	Add \$86.00 per device
10'0"	H1000	

ED4800 Device

Door Height	Specify	Add or Deduct
8'0"	(standard)	No Charge
8'2"	H0802	
8'6"	H0806	
9'0"	H0900	Add \$86.00 per device
10'0"	H1000	

Door Width Options

Door Width	Specify	Add or Deduct
24"	W024	Add \$305.00 per device
36"	(standard)	No Charge
48"	W048	Add \$37.00 per device

Door Thickness Options

Door Thickness	Specify	Add or Deduct
1-3/4"	(standard)	No Charge
2"	D200	
2-1/4"	D214	

Strike Options

Description	Specify	Add or Deduct
Surface or concealed vertical rod	S09	No Charge
Bottom strike for 1/2" threshold		
Flush transom top strike bracket	M67	Add \$31.00 per device

Miscellaneous Options

Description	Specify	Add or Deduct
Torx® screws for rim, concealed vertical rod, mortise	M04	Add \$48.00 per device
Torx® screws for surface vertical rod	M04	Add \$90.00 per device
Knurling outside and inside (Embossed Touchbar - device side)	M20	Add \$153.00 per device
Knurling outside only (trim side)	M21	Add \$72.00 per device
Knurling inside only (Embossed Touchbar - device side)	M22	Add \$81.00 per device
Abrasive coat outside and inside (trim and device)	M23	Add \$97.00 per device
Abrasive coat inside only (device side)	M24	Add \$51.00 per device
Abrasive coat outside only (trim side)	M25	Add \$46.00 per device
Pathlite™ Photoluminescent Touchbar cover	M49	Add \$364.00 per device
Less dogging	M51	No Charge
Cylinder dogging (less cylinder)	M52	Add \$82.00 per device
Sex nuts and bolts (SNBs)	M54	No Charge
Mullion stabilizer*	M57	Add \$63.00 per mullion
Shim kit (for vision light)		
- All rim and concealed vertical rod	M58	Add \$75.00 per device
- All surface vertical rod	M58	Add \$100.00 per device
End Cap Reinforcement (used with standard end cap only)	M109	Add \$82.00 per device
Flush End Cap	M110	No Charge

Removable Mullion
Ordering Example

Quantity	Mullion Number	Finish
10	CR808	628

Door Height	Specify	Finish	Price
Up to 8'0"	CR808	628	\$1,571.00
Up to 8'0"	CR808	695	\$1,804.00

*Standard with all 808 mullions.

Custom Laser Engraving- LASER
Laser engraving processing charge (all engraving types)

- \$250 net per order. Charge will be applied to production order when placed.

Single Vanity, Logo or Other (same engraving on all parts)

- Lever - \$10 net add each
- Mortise Escutcheon - \$10 net add each
- HPSK Paddle - \$10 net add each

Unique laser engraving (i.e. Room Number, Apartment Number, etc)

- \$12 net add each (per piece)

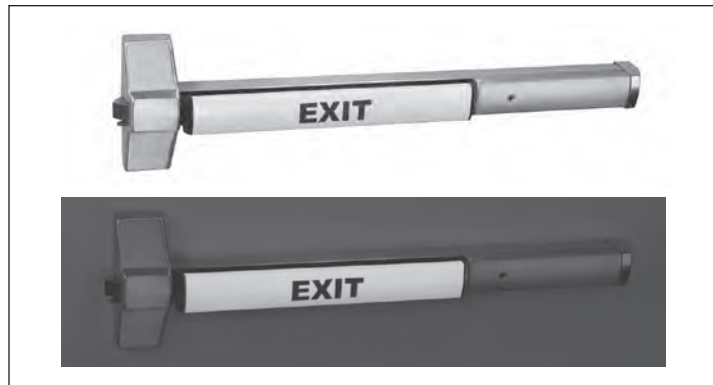

The PathLite™ patent pending technology offers a number of benefits:

- Requires no wiring or maintenance
- Recharges with exposure to ambient light
- Unaffected by heat or cold
- Non-toxic, will not rub off or fade
- Vandal resistant
- Fire resistant and non-radioactive
- Green contrasting word "EXIT" centered on touchbar in 1-1/4" high lettering
- Cost effective; especially suited for existing buildings

PathLite™ photoluminescent exit devices meet New York City's newly adopted standards for requirement of photoluminescent signage and stairwell markings in all office buildings in excess of 75 feet in height.

How To Order Complete Device

Exit Device	Trim/Function	Finish	Hand	Misc. Options
ED5200	N910ET	630	RHR	M49

ED5200 x N910 x 630 x RHR x M49

Options	Specify	Price
24", 36", and 48" PathLite™ Photoluminescent Touchbar Cover	M49	Add \$364.00 per device

How to Order Touchbar Cover Only

Options	Part Number	Price
24" PathLite™ Photoluminescent Touchbar cover	710F797	\$374.00
36" PathLite™ Photoluminescent Touchbar cover	710F737	
48" PathLite™ Photoluminescent Touchbar cover	710F747	

**Standard Features
Handing**

Devices are field reversible; specify hand. Lever trims are handed; specify hand.

Note:
Specify hand for all double cylinder exit devices

**Door Thickness
1-3/4"**

**Door Width
36"**

**Projection
3-1/4"; 2-3/4" dogged**

Trim
Cylinder is not included.
See page 292 for cylinder options.

- SecureBolt®**
 ED5200S Panic
 ED5200SA 3 Hour Fire Rated
 ED5202S Double Cylinder Panic, SecureBolt®
 ED5202SA Double Cylinder, Secure Bolt, 3 Hour Fire Rated

- RIM**
 ED5200 Panic
 ED5200A 3 Hour Fire Rated
 ED5202 Double Cylinder Panic
 ED5202A Double Cylinder; 3 Hour fire rated

- Vertical Rod**
 ED5400 Panic
 ED5470 Panic
 ED5400A 3 Hour Fire Rated
 ED5470B 1-1/2 Hour Fire Rated

- Concealed Vertical Rod**
 ED5800 Panic
 ED5860 Panic
 ED5800A 3 Hour Fire Rated
 ED5860B 1-1/2 Hour Fire Rated

- Mortise**
 ED5600 Panic
 ED5600A 3 Hour Fire Rated
 ED5602L Double Cylinder Panic (Classroom Function)
 ED5602AL Double Cylinder (Classroom Function); 3 Hour Fire Rated

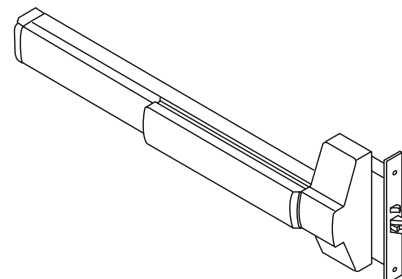
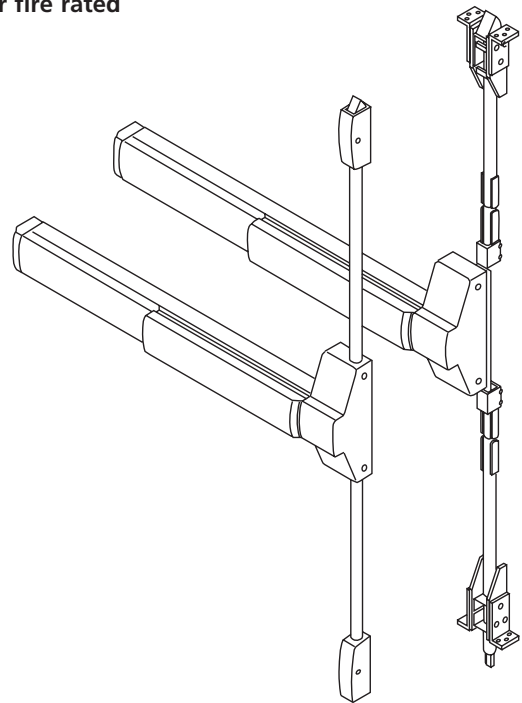
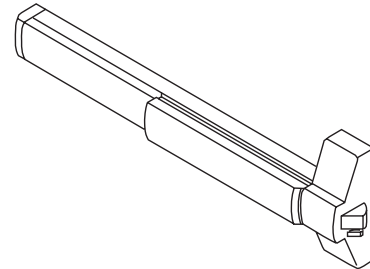

Ordering Examples

Exit Device with Trim

Quantity	Exit Device	Trim/Function	Finish	Hand	Door Thickness	Optional Strike	Door Width	Misc. Options
36	ED5600L	N9M55ET	605	LHR	D200	SB134	W048	M51-M54

Trim Only

Quantity	Trim/Function	Finish	Hand	Door Thickness
24	N955ET	625	RHR	D214

Contract/Detailed Order - Rim Exit Device with Trim

Quantity	Keyset	Exit Device	Trim/Function	Finish	Hand	Door Thickness	Door Width	Misc. Options	Optional Cylinder
36	AA1	ED5200	C955ET	613E	LHR	D200	W048	M52-M54	6P

Notes:

M55 less bottom rod option is available on ED5470(B) and ED5860(B) devices only.
H0900 and H1000 options are available on ED5470(B) and ED5860(B) devices only.
Non fire rated devices do not have a door size limitation set by UL.

36" Device Only

Includes device, strike(s) and screw pack. No cylinder or trim.

SecureBolt® ED5200S Series

Function	Description	Finish: 613E, 630, BSP, WSP	Finish: 605, 606, 611, 612, 613, 618, 619, 625, 629, 722
ED5200S	Panic	\$1,722.00	\$1,818.00
ED5202S ¹	Double Cylinder Panic <i>Classroom function Trim only</i>	\$1,944.00	\$2,040.00
ED5200SA	3 Hour Fire Rated	\$1,892.00	\$1,988.00
ED5202SA ¹	Double Cylinder 3 Hour Fire Rated <i>Classroom function Trim only</i>	\$2,114.00	\$2,210.00

Rim ED5200 Series

Function	Description	Finish: 613E, 630, BSP, WSP	Finish: 605, 606, 611, 612, 613, 618, 619, 625, 629, 722
ED5200	Panic	\$1,654.00	\$1,750.00
ED5202 ¹	Double Cylinder Panic <i>Classroom function Trim only</i>	\$1,876.00	\$1,972.00
ED5200A	3 Hour Fire Rated	\$1,824.00	\$1,920.00
ED5202A ¹	Double Cylinder 3 Hour Fire Rated <i>Classroom function Trim only</i>	\$2,046.00	\$2,142.00

Vertical Rod ED5400 Series

Function	Description	Finish: 613E, 630, BSP, WSP	Finish: 605, 606, 611, 612, 613, 618, 619, 625, 629, 722
ED5400	Panic	\$2,200.00	\$2,296.00
ED5470	Panic	\$2,266.00	\$2,362.00
ED5400A	3 Hour Fire Rated	\$2,370.00	\$2,466.00
ED5470B	1-1/2 Hour Fire Rated	\$2,436.00	\$2,532.00

Mortise ED5600 Series

Function	Description	Finish: 613E, 630, BSP, WSP	Finish: 605, 606, 611, 612, 613, 618, 619, 625, 629, 722
ED5600K	Panic	\$2,168.00	\$2,264.00
ED5657K			
ED5600L			
ED5657L			
ED5600T			
ED5657T			
ED5602L ¹	Double Cylinder Panic <i>Classroom function Trim only</i>	\$2,390.00	\$2,486.00
ED5600AK	3 Hour Fire Rated	\$2,338.00	\$2,434.00
ED5657AK			
ED5600AL			
ED5657AL			
ED5600AT			
ED5657AT			
ED5602AL ¹	Double Cylinder 3 Hour Fire Rated <i>Classroom function Trim only</i>	\$2,560.00	\$2,656.00
ED5633L	Access 800® Only - Panic – Without Cylinder	\$2,168.00	\$2,264.00
ED5634L	Access 800® Only - Panic – With Cylinder	\$2,168.00	\$2,264.00
ED5633AL	Access 800® Only - 3 Hour Fire Rated – Without Cylinder	\$2,338.00	\$2,434.00
ED5634AL	Access 800® Only - 3 Hour Fire Rated – With Cylinder	\$2,338.00	\$2,434.00

Concealed V.R. ED5800 Series

Function	Description	Finish: 613E, 630, BSP, WSP	Finish: 605, 606, 611, 612, 613, 619, 625, 629, 722
ED5800	Panic	\$2,457.00	\$2,553.00
ED5860	Panic	\$2,589.00	\$2,685.00
ED5800A	3 Hour Fire Rated	\$2,627.00	\$2,723.00
ED5860B	1-1/2 Hour Fire Rated	\$2,759.00	\$2,855.00

Inactive Bar ED5000DB Series

Function	Description	Finish: 613E, 630, BSP, WSP	Finish: 605, 606, 611, 612, 613, 619, 625, 629, 722
ED5000DB	Inactive Bar	\$815.00	\$911.00

1.Specify handing for double cylinder devices
 Only classroom function trim can be used with double cylinder devices.
 Caution: Be sure of your measurements. Exit devices are NOT returnable.

Pushpad Exit Devices

ED5000 Series: Muséo Levers with 900 Series Escutcheon

USA & Canada Prices Effective March 16, 2020



contemporary levers to complement the interior design of your next project

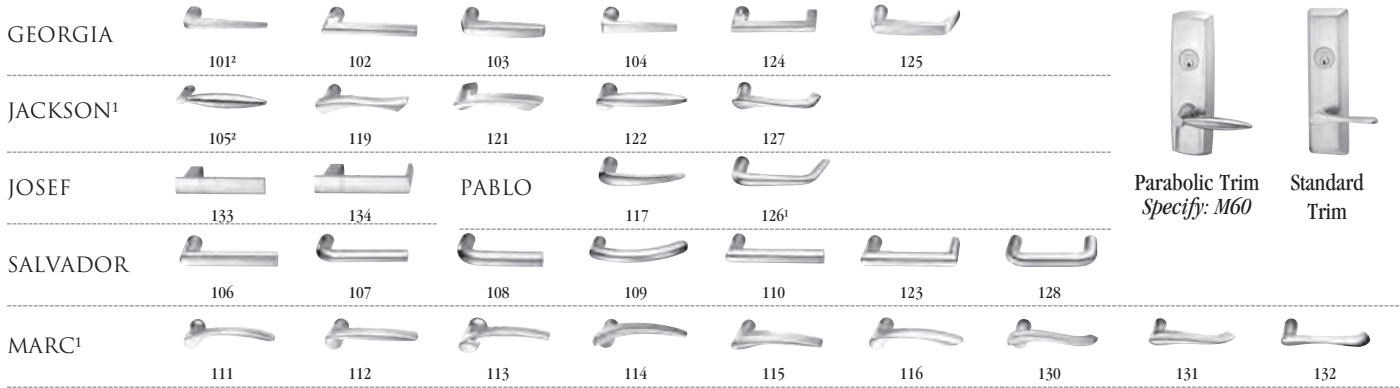

1. Handed: specify hand when ordering
2. Contact factory for current lead time

*629 and *630 finish options are Not available for all Muséo levers. Please refer to page 20 for availability.

605	Bright Brass, Clear Coated	613L	Dark Oxidized Satin Bronze, Clear Coated	WSP	White Suede Powder Coat
606	Satin Brass, Clear Coated	618	Bright Nickel Plated	722	Black Oxidized Bronze, Oil Rubbed
611	Bright Bronze, Clear Coated	619	Satin Nickel Plated		
612	Satin Bronze, Clear Coated	625	Bright Chromium Plated		
613	Dark Oxidized Satin Bronze, Oil Rubbed	629*	Bright Stainless Steel		
613E	Dark Oxidized Satin Bronze - Equivalent	630*	Satin Stainless Steel		
		BSP	Black Suede Powder Coat		

Function

Rim/SVR/CVR	910	Passage	\$733.00
	950	Dummy	
	955	Classroom	
	957	Nightlatch	
	959	Storeroom	
Mortise	9M10	Passage	\$733.00
	9M50	Dummy	
	9M55	Classroom	
	9M57	Nightlatch	
Electrified	9903	Fail Safe	\$1,121.00
	9905	Fail Secure	
Options	M60	Parabolic Escutcheon	Add \$82.00 per device

Ordering Example Details

- 111 Marc family lever
- 9M50 Dummy Trim; Mortise
- 625 Bright Chrome finish
- RHR Right Hand Reverse
- D214 2-1/4" Door Thickness
- M60 Parabolic Escutcheon Design (mechanical)



Trim Only					
Quantity	Trim/Function	Finish	Hand	Door Thickness	Option
24	1119M50	625	RHR	D214	M60



Experience a safer and more open world

Copyright © 2002-2020 Corbin Russwin, Inc., an ASSA ABLOY Group company. All rights reserved. Reproduction in whole or in part without the express written permission of Corbin Russwin, Inc., is prohibited. Contact us at: 800-543-3658 or visit www.corbinrusswin.com. In Canada contact us at: 800-461-3007 or visit www.assaabloydss.ca

Pushpad Exit Devices

ED5000 Series: Muséo Levers with 900 Series Escutcheon

USA & Canada Prices Effective March 16, 2020



contemporary levers to complement the interior design of your next project

GEORGES



Parabolic Trim
Specify: M60



Standard Trim

1. Handed: specify hand when ordering
2. Contact factory for current lead time

605	Bright Brass, Clear Coated	613L	Dark Oxidized Satin Bronze, Clear Coated	WSP	White Suede Powder Coat
606	Satin Brass, Clear Coated	618	Bright Nickel Plated	722	Black Oxidized Bronze, Oil Rubbed
611	Bright Bronze, Clear Coated	619	Satin Nickel Plated		
612	Satin Bronze, Clear Coated	625	Bright Chromium Plated		
613	Dark Oxidized Satin Bronze, Oil Rubbed	629*	Bright Stainless Steel		
613E	Dark Oxidized Satin Bronze - Equivalent	630*	Satin Stainless Steel		
		BSP	Black Suede Powder Coat		

Function

Rim/SVR/CVR	910	Passage	\$753.00
	950	Dummy	
	955	Classroom	
	957	Nightlatch	
	959	Storeroom	
Mortise	9M10	Passage	\$753.00
	9M50	Dummy	
	9M55	Classroom	
	9M57	Nightlatch	
Electrified	9903	Fail Safe	\$1,159.00
	9905	Fail Secure	
Options	M60	Parabolic Escutcheon	Add \$82.00 per device

Ordering Example Details

- 133 Josef family lever
- 9M50 Dummy Trim; Mortise
- 625 Bright Chrome finish
- RHR Right Hand Reverse
- D214 2-1/4" Door Thickness
- M60 Parabolic Escutcheon Design (mechanical)



Trim Only					
Quantity	Trim/Function	Finish	Hand	Door Thickness	Option
24	1339M50	625	RHR	D214	M60



Experience a safer
and more open world

Pushpad Exit Devices

ED5000 Series: Muséo Levers with 900 Series Escutcheon

USA & Canada Prices Effective March 16, 2020

contemporary levers to complement the interior design of your next project



*613E, BSP, WSP finishes are not available with 21M levers.



613E	Dark Oxidized Satin Bronze – Equivalent
629	Bright Stainless Steel
630	Satin Stainless Steel
BSP	Black Suede Powder Coat
WSP	White Suede Powder Coat

Function

Rim/SVR/CVR	910	Passage	\$753.00
	950	Dummy	
	955	Classroom	
	957	Nightlatch	
	959	Storeroom	
Mortise	9M10	Passage	\$753.00
	9M50	Dummy	
	9M55	Classroom	
	9M57	Nightlatch	
Electrified	9903	Fail Safe	\$1,159.00
	9905	Fail Secure	
Options	M60	Parabolic Escutcheon	Add \$82.00 per device



Ordering Example Details

21M Piet Family Lever - Polished with Satin Insert
 9M50 Dummy Trim; Mortise
 293029 Lever Finish
 Polished with satin stainless steel insert (630), polished stainless steel (629) shank and polished stainless steel (629) grip
 629 Lock Finish
 D214 2-1/4" Door Thickness
 M60 Parabolic Escutcheon Design (mechanical)

Trim Only						
Quantity	Trim/Function	Lever Finish	Lock Finish	Hand	Door Thickness	Option
2	21M9M50	293029	629	RHR	D214	M60



Experience a safer and more open world

ED5200S/ED5200/ED5400/ED5800 SecureBolt®, Rim, Surface and CVR Heavy-Duty Trim

Cylinder is not included.

Escutcheon Trim Design: A9 Armstrong



Lever: Cast

Escutcheon: Forged

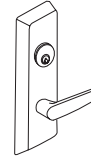

Function	Description	Finish: 605, 606, 611, 612, 613, 613E, 618, 619, 625, 626, 629 ² , 630 ¹ , 722, BSP
A910ET	Passage	\$733.00
A950ET	Dummy	
A955ET	Classroom ^{3,4}	
A957ET	Nightlatch ⁵	
A959ET	Storeroom	

Escutcheon Trim Design: C9 Citation



Lever: Cast

Escutcheon: Forged

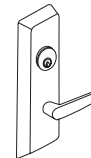

Function	Description	Finish: 605, 606, 611, 612, 613, 613E, 618, 619, 625, 626, 629 ² , 630 ¹ , 722, BSP
C910ET	Passage	\$733.00
C950ET	Dummy	
C955ET	Classroom ^{3,4}	
C957ET	Nightlatch ⁵	
C959ET	Storeroom	

Escutcheon Trim Design: D9 Dirke



Lever: Cast

Escutcheon: Forged

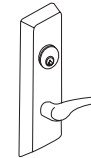

Function	Description	Finish: 605, 606, 611, 612, 613, 613E, 618, 619, 625, 626, 629 ² , 630 ¹ , 722, BSP
D910ET	Passage	\$733.00
D950ET	Dummy	
D955ET	Classroom ^{3,4}	
D957ET	Nightlatch ⁵	
D959ET	Storeroom	

Notes:

1. 619 finish provided to match 630 finish
2. 618 finish provided to match 629 finish.
3. Classroom function trim may be converted to storeroom function by a simple field adjustment. No additional parts required.
4. Only Classroom function may be used with Double Cylinder exit devices.
5. Not recommended for use with surface or concealed vertical rod exit devices (ED5400, ED5800)

ED5200S/ED5200/ED5400/ED5800 SecureBolt®, Rim, Surface and CVR Heavy-Duty Trim

Cylinder is not included.

Escutcheon Trim Design: E9 Essex



Lever: Cast **Escutcheon:** Forged

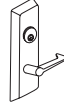

Function	Description	Finish: 605, 606, 611, 612, 613, 613E, 618, 619, 625, 626, 629 ² , 630 ¹ , 722, BSP
E910ET	Passage	\$733.00
E950ET	Dummy	
E955ET	Classroom ^{3,4}	
E957ET	Nightlatch ⁵	
E959ET	Storeroom	

Escutcheon Trim Design: L9 Lustra



Lever: Cast **Escutcheon:** Forged

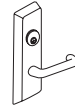

Function	Description	Finish: 605, 606, 611, 612, 613, 613E, 618, 619, 625, 626, 629 ² , 630 ¹ , 722, BSP
L910ET	Passage	\$733.00
L950ET	Dummy	
L955ET	Classroom ^{3,4}	
L957ET	Nightlatch ⁵	
L959ET	Storeroom	

Escutcheon Trim Design: N9 Newport



Lever: Cast **Escutcheon:** Forged

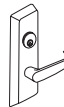

Function	Description	Finish: 605, 606, 611, 612, 613, 613E, 618, 619, 625, 626, 629 ² , 630 ¹ , 722, BSP
N910ET	Passage	\$733.00
N950ET	Dummy	
N955ET	Classroom ^{3,4}	
N957ET	Nightlatch ⁵	
N959ET	Storeroom	

Escutcheon Trim Design: R9 Regis



Lever: Cast **Escutcheon:** Forged

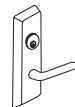

Function	Description	Finish: 605, 606, 611, 612, 613, 613E, 618, 619, 625, 626, 629 ² , 630 ¹ , 722, BSP
R910ET	Passage	\$733.00
R950ET	Dummy	
R955ET	Classroom ^{3,4}	
R957ET	Nightlatch ⁵	
R959ET	Storeroom	

Notes:

1. 619 finish provided to match 630 finish. - Escutcheons only
2. 618 finish provided to match 629 finish. - Escutcheons only
3. Classroom function trim may be converted to storeroom function by a simple field adjustment. No additional parts required.

4. Only Classroom function trim may be used with Double Cylinder exit devices.
5. Not recommended for use with surface or concealed vertical rod exit devices (ED5400, ED5800)

ED5200S/ED5200/ED5400/ED5800 SecureBolt®, Rim, Surface and CVR Heavy-Duty Trim

Cylinder is not included.

Escutcheon Trim Design: PR9 Princeton



Lever: Cast

Escutcheon: Forged



Function	Description	Finish: 605, 606, 611, 612, 613, 613E, 618, 619, 625, 626, 629 ² , 630 ¹ , 722, BSP
PR910ET	Passage	\$733.00
PR950ET	Dummy	
PR955ET	Classroom ^{3,4}	
PR957ET	Nightlatch ⁵	
PR959ET	Storeroom	

Escutcheon Trim Design: F9

Lever: Cast

Escutcheon: Forged



Function	Description	Finish: 605, 606, 611, 612, 613, 613E, 618, 619, 625, 626, 629 ² , 630 ¹ , 722, BSP
F950ET	Dummy	\$324.00
F957ET	Nightlatch ⁵	

Escutcheon Trim Design: G9

Lever: Cast

Escutcheon: Forged



Function	Description	Finish: 605, 606, 611, 612, 613, 613E, 618, 619, 625, 626, 629 ² , 630 ¹ , 722, BSP
G910ET	Passage	\$733.00
G950ET	Dummy	
G955ET	Classroom ^{3,4}	
G957ET	Nightlatch ⁵	
G959ET	Storeroom	

Escutcheon Trim Design: VT9

Plate: Stamped or Formed Stainless Steel



Function	Description	Finish: 630 ¹
VT957ET	Nightlatch ⁶	\$645.00
VTL957ET	Nightlatch with Lip ⁶	
VT950ET	Pull	
VTL950ET	Pull with Lip	

Notes:

1. 619 finish provided to match 630 finish. - Escutcheons only
2. 618 finish provided to match 629 finish. - Escutcheons only
3. Classroom function trim may be converted to storeroom function by a simple field adjustment. No additional parts required.

4. Only Classroom function trim may be used with Double Cylinder exit devices.
5. Not recommended for use with surface or concealed vertical rod exit devices (ED5400, ED5800)
6. VT957 and VTL957 trims are handed and not reversible

ED5200S/ED5200/ED5400/ED5800 SecureBolt® , Rim, Surface and CVR Heavy-Duty Trim

Cylinder is not included.

Escutcheon Trim Design: FR9 Frascati*



Escutcheon: Forged

* Handed Lever. Handing cannot be changed in the field.

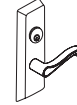

Function	Description	Finish: 605, 606, 611, 612, 613, 613E, 618, 619, 625, 626, 629 ² , 630 ¹ , 722, BSP
FR910ET	Passage	\$733.00
FR950ET	Dummy	
FR955ET	Classroom ^{3,4}	
FR957ET	Nightlatch ⁵	
FR959ET	Storeroom	

Escutcheon Trim Design: M9 Merlot



Escutcheon: Forged

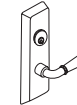

Function	Description	Finish: 605, 606, 611, 612, 613, 613E, 618, 619, 625, 626, 629 ² , 630 ¹ , 722, BSP
M910ET	Passage	\$733.00
M950ET	Dummy	
M955ET	Classroom ^{3,4}	
M957ET	Nightlatch ⁵	
M959ET	Storeroom	

Escutcheon Trim Design: Z9 Zinfandel*



Escutcheon: Forged

* Handed Lever. Handing cannot be changed in the field.

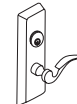

Function	Description	Finish: 605, 606, 611, 612, 613, 613E, 618, 619, 625, 626, 629 ² , 630 ¹ , 722, BSP
Z910ET	Passage	\$733.00
Z950ET	Dummy	
Z955ET	Classroom ^{3,4}	
Z957ET	Nightlatch ⁵	
Z959ET	Storeroom	

Notes:

- 3. Classroom function trim may be converted to storeroom function by a simple field adjustment. No additional parts required.
- 4. Only Classroom function trim may be used with Double Cylinder exit devices.
- 5. Not recommended for use with surface or concealed vertical rod exit devices.

ED5200S/ED5200/ED5400/ED5800 SecureBolt®, Rim, Surface and CVR Trim

Cylinder is not included.

Escutcheon Trim Design: TH900 Pull/Thumbpiece

Grip: Extruded

Escutcheon: Forged



Function	Description	Finish: 605, 606, 611, 612, 613, 613E, 618, 619, 625, 626, 629 ² , 630 ¹ , 722, BSP
TH910ET	Passage	\$534.00
TH950ET	Dummy (No thumbpiece)	\$504.00
TH955ET	Classroom ^{3,4}	\$534.00
TH957ET	Nightlatch ⁵ (No thumbpiece)	\$504.00
TH959ET	Storeroom	\$504.00

Escutcheon Trim Design: P9 Pull



Pull: Extruded

Escutcheon: Forged

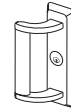

Function	Description	Finish: 605, 606, 611, 612, 613, 613E, 618, 619, 625, 626, 629 ² , 630 ¹ , 722, BSP
P950ET*	Dummy	\$461.00
P957ET*	Nightlatch ⁵	

* Specify Hand. Field Reversible.

Escutcheon Trim Design: K1 Key Only

Note: Only available with cylinder option. Example K157 x 6P



Function	Description	Finish: 605, 606, 611, 612, 613, 618, 619, 622, 625, 626, 722
K157ET	Nightlatch ⁵	\$62.00

Note:

1. 619 finish provided to match 630 finish. - Escutcheons only
2. 618 finish provided to match 629 finish. - Escutcheons only
3. Classroom function trim may be converted to storeroom function by a simple field adjustment. No additional parts required.
4. Only Classroom function trim may be used with Double Cylinder exit devices.
5. Not recommended for use on surface or concealed vertical rod exit devices.

ED5600 Mortise Heavy-Duty Trim

Cylinder is not included.

Escutcheon Trim Design: A4M Armstrong



Lever: Cast

Escutcheon: Forged

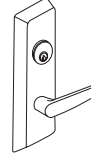

Function	Description	Finish: 605, 606, 611, 612, 613, 613E, 618, 619, 625, 626, 629 ² , 630 ¹ , 722, BSP
A9M10ET	Passage ³	\$733.00
A9M50ET	Dummy ³	
A9M55ET	Classroom ^{4, 5}	
A9M57ET	Nightlatch ⁴	

Escutcheon Trim Design: C9M Citation



Lever: Cast

Escutcheon: Forged

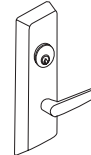

Function	Description	Finish: 605, 606, 611, 612, 613, 613E, 618, 619, 625, 626, 629 ² , 630 ¹ , 722, BSP
C9M10ET	Passage ³	\$733.00
C9M50ET	Dummy ³	
C9M55ET	Classroom ^{4, 5}	
C9M57ET	Nightlatch ⁴	

Escutcheon Trim Design: D9M Dirke*



Lever: Cast

Escutcheon: Forged

* Handed Lever. Handing cannot be changed in the field.

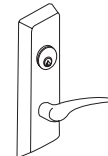

Function	Description	Finish: 605, 606, 611, 612, 613, 613E, 618, 619, 625, 626, 629 ² , 630 ¹ , 722, BSP
D9M10ET	Passage ³	\$733.00
D9M50ET	Dummy ³	
D9M55ET	Classroom ^{4, 5}	
D9M57ET	Nightlatch ⁴	

Notes:

1. 619 finish provided to match 630 finish. - Escutcheons only
2. 618 finish provided to match 629 finish. - Escutcheons only
3. Dummy and passage functions are the same. For dummy function, mortise lock body must be installed in the locked mode. No additional parts required.
4. Classroom and nightlatch function trims are the same. Trim function must be specified when ordered with an exit device to ensure that the correct lock body is supplied.
5. Only Classroom function trim may be used with Double Cylinder exit devices.

ED5600 Mortise Heavy-Duty Trim

Cylinder is not included.

Escutcheon Trim Design: E9M Essex



Lever: Cast

Escutcheon: Forged

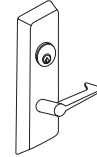

Function	Description	Finish: 605, 606, 611, 612, 613, 613E, 618, 619, 625, 626, 629 ² , 630 ¹ , 722, BSP
E9M10ET	Passage ³	\$733.00
E9M50ET	Dummy ³	
E9M55ET	Classroom ^{4, 5}	
E9M57ET	Nightlatch ⁴	

Escutcheon Trim Design: L9M Lustra



Lever: Cast

Escutcheon: Forged

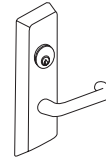

Function	Description	Finish: 605, 606, 611, 612, 613, 613E, 618, 619, 625, 626, 629 ² , 630 ¹ , 722, BSP
L9M10ET	Passage ³	\$733.00
L9M50ET	Dummy ³	
L9M55ET	Classroom ^{4, 5}	
L9M57ET	Nightlatch ⁴	

Escutcheon Trim Design: N9M Newport



Lever: Cast

Escutcheon: Forged

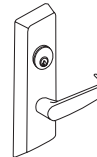

Function	Description	Finish: 605, 606, 611, 612, 613, 613E, 618, 619, 625, 626, 629 ² , 630 ¹ , 722, BSP
N9M10ET	Passage ³	\$733.00
N9M50ET	Dummy ³	
N9M55ET	Classroom ^{4, 5}	
N9M57ET	Nightlatch ⁴	

Notes:

1. 619 finish provided to match 630 finish. - Escutcheons only
2. 618 finish provided to match 629 finish. - Escutcheons only
3. Dummy and passage functions are the same. For dummy function, mortise lock body must be installed in the locked mode. No additional parts required.
4. Classroom and nightlatch function trims are the same. Trim function must be specified when ordered with an exit device to ensure that the correct lock body is supplied.
5. Only Classroom function trim may be used with Double Cylinder exit devices.

ED5600 Mortise Heavy-Duty Trim

Cylinder is not included.

Escutcheon Trim Design: R9M Regis



Lever: Cast **Escutcheon:** Forged

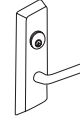

Function	Description	Finish: 605, 606, 611, 612, 613, 613E, 618, 619, 625, 626, 629 ² , 630 ¹ , 722, BSP
R9M10ET	Passage ³	\$733.00
R9M50ET	Dummy ³	
R9M55ET	Classroom ^{4, 5}	
R9M57ET	Nightlatch ⁴	

Escutcheon Trim Design: PR9M Princeton



Lever: Cast **Escutcheon:** Forged



Function	Description	Finish: 605, 606, 611, 612, 613, 613E, 618, 619, 625, 626, 629 ² , 630 ¹ , 722, BSP
PR9M10ET	Passage ³	\$733.00
PR9M50ET	Dummy ³	
PR9M55ET	Classroom ^{4, 5}	
PR9M57ET	Nightlatch ⁴	

Escutcheon Trim Design: F9

Escutcheon: Forged



Function	Description	Finish: 605, 606, 611, 612, 613, 613E, 618, 619, 625, 626, 629 ² , 630 ¹ , 722, BSP
F950ET	Dummy	\$324.00
F9M57ET	Nightlatch ⁴	

Escutcheon Trim Design: G9M

Escutcheon: Forged



Function	Description	Finish: 605, 606, 611, 612, 613, 613E, 618, 619, 625, 626, 629 ² , 630 ¹ , 722, BSP
G9M10ET	Passage ³	\$733.00
G9M50ET	Dummy ³	
G9M55ET	Classroom ^{4, 5}	
G9M57ET	Nightlatch ⁴	

Notes:

1. 619 finish provided to match 630 finish. - Escutcheons only
2. 618 finish provided to match 629 finish. - Escutcheons only
3. Dummy and passage functions are the same. For dummy function, mortise lock body must be installed in the locked mode. No additional parts required.

4. Classroom and nightlatch function trims are the same. Trim function must be specified when ordered with an exit device to ensure that the correct lock body is supplied.
5. Only Classroom function trim may be used with Double Cylinder exit devices.

ED5600 Mortise Heavy-Duty Trim

Cylinder is not included.

Escutcheon Trim Design: FR9M Frascati*



Lever: Cast

Escutcheon: Forged



* Handed Lever. Handing cannot be changed in the field.

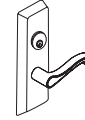

Function	Description	Finish: 605, 606, 611, 612, 613, 613E, 618, 619, 625, 626, 629 ² , 630 ¹ , 722, BSP
FR9M10ET	Passage ¹	\$733.00
FR9M50ET	Dummy ¹	
FR9M55ET	Classroom ^{2, 3}	
FR9M57ET	Nightlatch ²	

Escutcheon Trim Design: M9M Merlot



Lever: Cast

Escutcheon: Forged

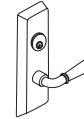

Function	Description	Finish: 605, 606, 611, 612, 613, 613E, 618, 619, 625, 626, 629 ² , 630 ¹ , 722, BSP
M9M10ET	Passage ¹	\$733.00
M9M50ET	Dummy ¹	
M9M55ET	Classroom ^{2, 3}	
M9M57ET	Nightlatch ²	

Escutcheon Trim Design: Z9M Zinfandel*



Lever: Cast

Escutcheon: Forged



* Handed Lever. Handing cannot be changed in the field.

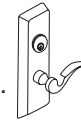

Function	Description	Finish: 605, 606, 611, 612, 613, 613E, 618, 619, 625, 626, 629 ² , 630 ¹ , 722, BSP
Z9M10ET	Passage ¹	\$733.00
Z9M50ET	Dummy ¹	
Z9M55ET	Classroom ^{2, 3}	
Z9M57ET	Nightlatch ²	

Notes:

- Dummy and passage functions are the same. For dummy function, mortise lock body must be installed in the locked mode. No additional parts required.
- Classroom and nightlatch function trims are the same. Trim function must be specified when ordered with an exit device to ensure that the correct lock body is supplied.
- Only Classroom function trim may be used with Double Cylinder exit devices.

Mortise Trim Design: ED5600

Cylinder is not included.

Escutcheon Trim Design: TH900, TH9M00 Pull/Thumbpiece

Grip: Extruded **Escutcheon:** Forged



Function	Description	Finish: 605, 606, 611, 612, 613, 613E, 618, 619, 625, 626, 629 ² , 630 ¹ , 722, BSP
TH9M10ET	Passage	\$534.00
TH950ET	Dummy (No Thumbpiece)	\$504.00
TH9M55ET	Classroom ³	\$534.00
TH9M57ET	Nightlatch (No Thumbpiece)	\$504.00

Escutcheon Trim Design: P9M Pull



Pull: Extruded **Escutcheon:** Forged

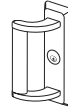

Function	Description	Finish: 605, 606, 611, 612, 613, 613E, 618, 619, 625, 626, 629 ² , 630 ¹ , 722, BSP
P950ET*	Dummy	\$461.00
P9M57ET*	Nightlatch	

*Specify Hand. Field Reversible.

Escutcheon Trim Design: VT9M

Plate: Stamped or Formed Stainless Steel



Function	Description	Finish: 630
VT9M57ET	Nightlatch	\$645.00
VTL9M57ET	Nightlatch with Lip	

Note: For mortise exit dummy functions, specify VT950 and VTL950

Escutcheon Trim Design: K1M Key Only

Note: Available with cylinder option only. Example: K1M57 x 6P



Function	Description	Finish: 605, 606, 611, 612, 613, 618, 619, 622, 625, 626, 722
K1M57ET	Nightlatch	\$62.00

Note:
 1. 619 finish provided to match 630 finish. - Escutcheons only
 2. 618 finish provided to match 629 finish. - Escutcheons only
 3. Only Classroom function trim may be used with Double Cylinder exit devices.

ED5200S/ED5200/ED5400/ED5800 SecureBolt®, Rim, Surface & CVR Heavy-Duty Trim

Cylinder is not included.

Escutcheon Trim Design: A9 Armstrong



Lever: Cast **Escutcheon:** Forged

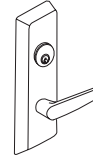

Function	Description	Finish: 605, 606, 611, 612, 613, 613E, 618, 619, 625, 626, 629 ² , 630 ¹ , 722, BSP
A9903ET*	Fail Safe	\$1,121.00
A9905ET*	Fail Secure	

Escutcheon Trim Design: C9 Citation



Lever: Cast **Escutcheon:** Forged

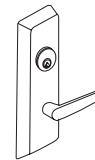

Function	Description	Finish: 605, 606, 611, 612, 613, 613E, 618, 619, 625, 626, 629 ² , 630 ¹ , 722, BSP
C9903ET*	Fail Safe	\$1,121.00
C9905ET*	Fail Secure	

Escutcheon Trim Design: D9 Dirke*



Lever: Cast **Escutcheon:** Forged
* Handed Lever. Handing cannot be changed in the field.

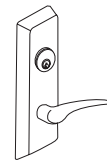

Function	Description	Finish: 605, 606, 611, 612, 613, 613E, 618, 619, 625, 626, 629 ² , 630 ¹ , 722, BSP
D9903ET*	Fail Safe	\$1,121.00
D9905ET*	Fail Secure	

Escutcheon Trim Design: E9 Essex



Lever: Cast **Escutcheon:** Forged

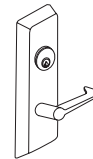

Function	Description	Finish: 605, 606, 611, 612, 613, 613E, 618, 619, 625, 626, 629 ² , 630 ¹ , 722, BSP
E9903ET*	Fail Safe	\$1,121.00
E9905ET*	Fail Secure	

Notes:
1. 619 finish provided to match 630 finish. - Escutcheons only
2. 618 finish provided to match 629 finish. - Escutcheons only



***ElectroLynx®**
As part of their promise to provide innovative, fast and effective high security solutions to their customers, certain ASSA ABLOY Group brands offer *ElectroLynx®*, a universal quick-connect system that simplifies the electrification of the door opening.

ED5200S/ED5200/ED5400/ED5800 SecureBolt® , Rim, Surface & CVR Heavy-Duty Trim

Cylinder is not included.

Escutcheon Trim Design: L9 Lustra



Lever: Cast **Escutcheon:** Forged

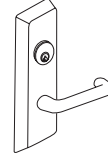

Function	Description	Finish: 605, 606, 611, 612, 613, 613E, 618, 619, 625, 626, 629 ² , 630 ¹ , 722, BSP
L9903ET*	Fail Safe	\$1,121.00
L9905ET*	Fail Secure	

Escutcheon Trim Design: N9 Newport



Lever: Cast **Escutcheon:** Forged

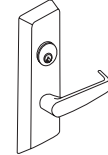

Function	Description	Finish: 605, 606, 611, 612, 613, 613E, 618, 619, 625, 626, 629 ² , 630 ¹ , 722, BSP
N9903ET*	Fail Safe	\$1,121.00
N9905ET*	Fail Secure	

Escutcheon Trim Design: R9 Regis



Lever: Cast **Escutcheon:** Forged

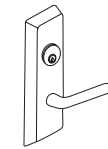

Function	Description	Finish: 605, 606, 611, 612, 613, 613E, 618, 619, 625, 626, 629 ² , 630 ¹ , 722, BSP
R9903ET*	Fail Safe	\$1,121.00
R9905ET*	Fail Secure	

Escutcheon Trim Design: PR9 Princeton



Lever: Cast **Escutcheon:** Forged

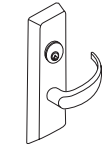

Function	Description	Finish: 605, 606, 611, 612, 613, 613E, 618, 619, 625, 626, 629 ² , 630 ¹ , 722, BSP
PR9903ET*	Fail Safe	\$1,121.00
PR9905ET*	Fail Secure	

Notes:
1. 619 finish provided to match 630 finish. - Escutcheons only
2. 618 finish provided to match 629 finish. - Escutcheons only



***ElectroLynx®**
As part of their promise to provide innovative, fast and effective high security solutions to their customers, certain ASSA ABLOY Group brands offer *ElectroLynx®*, a universal quick-connect system that simplifies the electrification of the door opening.

ED5200S/ED5200/ED5400/ED5800 SecureBolt®, Rim, Surface & CVR Heavy-Duty Trim

Cylinder is not included.

Escutcheon Trim Design: FR9 Frascati



Lever: Cast **Escutcheon:** Forged

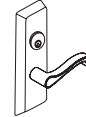

Function	Description	Finish: 605, 606, 611, 612, 613, 613E, 618, 619, 625, 626, 629 ² , 630 ¹ , 722, BSP
FR9903ET*	Fail Safe	\$1,121.00
FR9905ET*	Fail Secure	

Escutcheon Trim Design: M9 Merlot



Lever: Cast **Escutcheon:** Forged

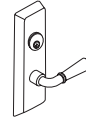

Function	Description	Finish: 605, 606, 611, 612, 613, 613E, 618, 619, 625, 626, 629 ² , 630 ¹ , 722, BSP
M9903ET*	Fail Safe	\$1,121.00
M9905ET*	Fail Secure	

Escutcheon Trim Design: Z9 Zinfandel



Lever: Cast **Escutcheon:** Forged

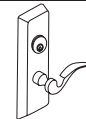

Function	Description	Finish: 605, 606, 611, 612, 613, 613E, 618, 619, 625, 626, 629 ² , 630 ¹ , 722, BSP
Z9903ET*	Fail Safe	\$1,121.00
Z9905ET*	Fail Secure	



***ElectroLynx®**

As part of their promise to provide innovative, fast and effective high security solutions to their customers, certain ASSA ABLOY Group brands offer *ElectroLynx®*, a universal quick-connect system that simplifies the electrification of the door opening.

Offset Pull Trim: P12, P13, P14

Offset Pull Trim	Part Number	Finish: 605, 606, 612, 613, 613E, 630, 626, 629, BSP, WSP
P12	716F50M X Finish	\$304.00
P13	716F51M X Finish	\$370.00
P14	716F52M X Finish	\$261.00

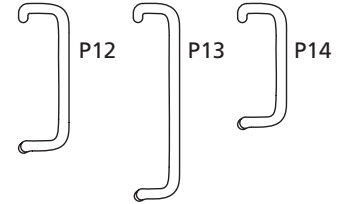

Electrified Options for Exit Devices

Description	Specify	Add or Deduct
Exit Alarm Device (cylinder is not included)	M61	\$770.00
Bolt Position Monitoring	M91*	Add \$227.00
Touchbar Monitoring or Signaling/Request to Exit (REX)	M92*	Add \$213.00
Outside Trim Monitoring or Signaling	M93*	
Motor Latch Retraction	MELR	Add \$852.00
Electric Dogging	M97*	Add \$435.00
SPDT Lock and Unlock security monitor switch (Electric Trim Only)	M98*	Add \$205.00
Trim gasket for exterior applications (Electric Trim Only)	M99	Add \$23.00
Mortise device lock with Outside Trim Control (Fail Safe)	SAF ² *	\$775.00
Mortise device lock with Outside Trim Control (Fail Secure)	SEC ² *	

Delayed Egress Device

Description	Suffix	Add or Deduct
Delayed Egress (Suffix the letter D to device. Ex: ED4200)	D	Add \$1672.00
30-Second Delay	M88*	\$116.00
BOCA 15-Second Delay	M89*	
BOCA 30-Second Delay	M90*	

Notes:

- Alarm kit cannot be installed in the field to surface vertical rod exit device. Any attempt to do so voids all warranties.
- Only available with ED5600(A) (Except knob trim)
- M88, M89 and M90 are available only as options for suffix "D" Delayed Egress Exit Devices.
- The following options cannot be ordered together on the same device: a) M94 or M97 & D; b) M94 x M97; c) M52 x M97; d) M97 x M107; e) M61 or M92 & D; f) M61 x M92; g) M61x M52; h) M52 & D; i) ED5600 x M91 & M93; j) ED5600 SAF or SEC x M91 or M93; k) Surface vertical rod exit devices with M61 x M91, M92 or M93.



***ElectroLynx®**

As part of their promise to provide innovative, fast and effective high security solutions to their customers, certain ASSA ABLOY Group brands offer *ElectroLynx®*, a universal quick-connect system that simplifies the electrification of the door opening.

Retrofit Kit: MELR rail assy, no switches, no latch, with controller, touchbar end cap

Description	Specify	Price
Device ASSY, MELR 36"	727F158	Add \$852.00
Device ASSY, MELR 36" NS (Narrow Stile)	727F228	
Device ASSY, MELR 48"	727F238	
Device ASSY, MELR WS 36" Device	727F248	
Device ASSY, MELR WS 48" Device	727F258	

Electrified Accessories

Part Number	Description	Specify	Price
709F609	Power Supply 1 Amp (controls 1 "D" device)	BPS-24-1	\$355.00
709F619	Power Supply 2 Amp (controls 2 "D" devices or 1 "D" with SAF or SEC)	BPS-24-2	\$722.00
709F629	Power Supply 4 amp 24VDC	BPS-24-4	\$1,220.00
704F288	Concealed transfer (for over 120-degree swing door)	EPTL	\$140.00
709F689	(1) SPDT Maintained Switch (Includes LED)	MKA	\$140.00
709F709	(1) SPDT Momentary Switch (Includes LED)	MK	\$214.00
709F749	(1) SPDT Momentary Switch (Illuminated)	PB2	\$164.00
709F759	(1) SPDT Maintained (Alternating Action) Switch	PB3EA	\$125.00
709F769	(1) SPDT Momentary Switch (Illuminated)	PB3	\$159.00
709F779	(1) SPDT Momentary Switch	2' PB3ER	\$106.00
709F729	DPDT Momentary Key Switch	2' MK2	\$246.00
709F699	Narrow Stile Key Switch (Alt. action)	MKAN	\$214.00
704F719	Narrow Stile Momentary Key Switch	MKN	\$214.00
709F789	Sonalert 90db @ 2 ft. 12-24VDC Mounted on one gang stainless steel plate.	PZ1	\$106.00
	Alarm Kit (cylinder is not included)'	ED50AK	\$875.00
709F679	Door Cord	TSB-C	\$45.00
741F739	Digital Entry System (4 users)	DK-12	\$39.00
709F809	Digital Entry System (59 users) SS finish	FADK-26SS	\$753.00
709F819	Digital Entry System (59 users) Black finish	DK-26BK	\$753.00
709F989	Remote Power Harness – 36"		\$140.00
709F999	Remote Power Harness – 48"		\$155.00

Custom Laser Engraving- LASER
Laser engraving processing charge (all engraving types)

- \$250 net per order. Charge will be applied to production order when placed.

Single Vanity, Logo or Other (same engraving on all parts)

- Lever - \$10 net add each
- Mortise Escutcheon - \$10 net add each
- HPSK Paddle - \$10 net add each

Unique laser engraving (i.e. Room Number, Apartment Number, etc)

- \$12 net add each (per piece)

Cylinder Options*

Description	Specify	Add or Deduct
Conventional 6-pin	6P**	Add \$93.00 per cylinder
Conventional 7-pin	7P	Add \$95.00 per cylinder
Access 3 Patented	AP	Add \$93.00 per cylinder
Access 3 Security	AS	Add \$142.00 per cylinder
Access 3 High Security, UL 437	AHS	Add \$162.00 per cylinder
Access 3 IC Patented	ACP	Add \$173.00 per cylinder
Access 3 IC Security	ACS	Add \$222.00 per cylinder
Access 3 IC High Security, UL 437	ACHS	Add \$242.00 per cylinder
Pyramid Security fixed core	PS	Add \$157.00 per cylinder
Pyramid Security IC	PCS	Add \$233.00 per cylinder
Pyramid High Security fixed core	PHS	Add \$189.00 per cylinder
Pyramid High Security IC	PCHS	Add \$264.00 per cylinder
Pyramid IC with temporary construction core	CTP	Add \$173.00 per cylinder
Pyramid IC with temporary disposable core	CTPD	Add \$93.00 per cylinder
Pyramid IC less core	CLP	Add \$93.00 per cylinder
Security	HS	Add \$214.00 per cylinder
Security IC	CHS	Add \$292.00 per cylinder
IC 6-pin	C6	Add \$173.00 per cylinder
IC 6-pin with temporary construction core (Red)	CT6R	Add \$173.00 per cylinder
IC 6-pin with temporary construction core (Blue)	CT6B	Add \$173.00 per cylinder
IC 6-pin with temporary construction core (Green)	CT6G	Add \$173.00 per cylinder
IC 6-pin with temporary disposable core	CT6D	Add \$93.00 per cylinder
IC 6-pin less core	CL6	Add \$93.00 per cylinder
SFIC 6-pin with Less Core	CLS6	Add \$93.00 per cylinder
IC 6-pin with SFIC disposable temporary core	CT6SD	Add \$93.00 per cylinder
IC 7-pin	C7	Add \$177.00 per cylinder
IC 7-pin with temporary construction core (Red)	CT7R	Add \$177.00 per cylinder
IC 7-pin with temporary construction core (Blue)	CT7B	Add \$177.00 per cylinder
IC 7-pin with temporary construction core (Green)	CT7G	Add \$177.00 per cylinder
IC 7-pin with temporary disposable core	CT7D	Add \$95.00 per cylinder
IC 7-pin less core	CL7	Add \$95.00 per cylinder
SFIC 7-pin with Less Core	CLS7	Add \$95.00 per cylinder
IC 7-pin with SFIC disposable temporary core	CT7SD	Add \$95.00 per cylinder

*Optional dogging cylinder will be furnished with the same mechanism and keyed alike with the trim cylinder, unless otherwise specified. If different keying or cylinder type is required, specify outside (trim) first, then inside (dogging) cylinder.

**6P cylinder option is supplied in 6-pin, L4 keyway, 0-bitted with two nickel silver keys.

Keying Options*

Description	Specify	Add or Deduct
0-Bitted with 2 blank keys	(standard)	No Charge
Keyed random	KR	No Charge
Master keyed (all cylinders except 8000, 8020, 8027 IC)	specify keyset	Add \$16.00 per cylinder
Master keyed Pyramid	specify keyset	Add \$16.00 per cylinder
Master keyed Security (including IC cylinder and core)	specify keyset	Add \$16.00 per cylinder
Master keyed (8000, 8020, 8027 IC core)	specify keyset	No Charge
Master keyed to customer bittings or sample key	specify keyset	Add \$16.00 per cylinder
Construction master keyed ^{1,2}	CMK	Add \$16.00 per cylinder
Visual key control (VKC)		
- No Stamping	VKC0	\$4.50
- Keys only	VKC1	No Charge
- Cylinders and Keys ³	VKC2	\$8.00
- Cylinders only ³	VKC3	\$8.00
Concealed key control (CKC)		
- CKC cylinders with VKC keys	CKC2	\$8.00
- CKC cylinders only ³	CKC3	\$8.00
More than 2 keys per lock	KY# (e.g., KY6)	See page 31 - Cut Keys Section

*For key bows other than 10 and 90, specify "KB" + bow number as Quick Code, e.g. KB12.

Notes:

1. CMK Construction master keying charge is in addition to master keying charge.
2. CMK Construction master keying is not available in interchangeable core, Access 3, Pyramid, or Security series.
3. VKC2, VKC3, CKC3 are not available in Pyramid or Security series.

Door Height Options
ED5400, ED5400A, ED5470(B) Devices

Door Height	Specify	Add or Deduct
7'0"	(standard)	No Charge
7'2"	H0702	
7'6"	H0706	
8'0"	H0800	

ED5800, ED5800A, ED5860(B) Devices

Door Height	Specify	Add or Deduct
8'0"	(standard)	No Charge

ED5470(B), ED5860(B) Devices

Door Height	Specify	Add or Deduct
9'0" ¹	H0900	Add \$86.00 per device
10'0" ¹	H1000	

Door Width Options

Door Width	Specify	Add or Deduct
24"	W024	Add \$305.00 per device
36"	(standard)	No Charge
48"	W048	Add \$37.00 per device

Door Thickness Options

Door Thickness	Specify	Add or Deduct
1-3/4"	(standard)	No Charge
2"	D200	
2-1/4"	D214	

Strike Options

Description	Specify	Add or Deduct
Rim x Vertical Rod on pairs of doors	S02	Add \$38.00 per device
Surface or Concealed Vertical Rod device bottom strike for 1/2" threshold	S09	No Charge
Flush transom top strike bracket	M67	Add \$31.00 per device
Mortise Device		
-ANSI wrought strike box	M17	No Charge
-ANSI strike for pair of doors w/ astragal (7/8" L to C)	SS078	
-Open back strike for 1-3/4" door	SB134	Add \$87.00 per device
-Open back strike for 2-1/4" door	SB214	\$140.00

Note:

1. H0900 and H1000 options for ED5470(B), ED5860(B) devices only

Miscellaneous Options

Description	Specify	Add or Deduct
Torx® screws for rim, concealed vertical rod, mortise	M04	Add \$48.00 per device
Torx® screws for surface vertical rod	M04	Add \$90.00 per device
Knurling outside and inside (Embossed Touchbar - device side) ¹	M20	Add \$153.00 per device
Knurling outside only (trim side) ¹	M21	Add \$72.00 per device
Knurling inside only (Embossed Touchbar - device side)	M22	Add \$81.00 per device
Abrasive coat outside and inside (trim and device)	M23	Add \$97.00 per device
Abrasive coat inside only (device side)	M24	Add \$51.00 per device
Abrasive coat outside only (trim side)	M25	Add \$46.00 per device
Pathlite™ Photoluminescent Touchbar cover	M49	Add \$364.00 per device
Less dogging	M51	No Charge
Cylinder dogging (less cylinder)	M52	Add \$82.00 per device
Sex nuts and bolts (SNBs)	M54	No Charge
Less bottom vertical rod ²	M55	
Narrow stile cover	M56	No Charge
Shim kit (for vision light)		
- All rim and concealed vertical rod	M58	Add \$75.00 per device
- All surface vertical rod	M58	Add \$100.00 per device
- All mortise exit devices	M58	Add \$100.00 per device
Parabolic Design Exit Trim	M60	Add \$82.00 per device
Wood screws For use on fire rated solid wood or wood core doors	M64	No Charge
Windstorm Certified products for ED5200S(A) and ED5470(B) Only ^{3, 4, 5}	M107	Add \$89.00 per device
End Cap Reinforcement (used with standard end cap only)	M109	Add \$82.00 per device
Flush End Cap	M110	No Charge
5 lbs Pressure Release	5CH	Add \$29.00

Notes:

1. Not available with VT9, VTL9, VT9M and VTL9M trim.
2. Available with ED5470 and ED5860 series only.
3. ED5200S(A) x M107 requires through bolts.
4. ED5470(B) maximum opening height is 8'0".
5. Contact Ceco, Curries® or Fleming for detailed frame/door requirements and limitations.

Surface Bolt™

Description	Specify	Price
Surface Bolt Kit For Approved Windstorm Code Applications - bright zinc plated finish	988CR	\$154.00

Mullions
Ordering Example

Quantity	Mullion Number
10	907A

Removable Mullions

Door Height	Description	Specify	Price
Up to 7'0"	Steel Mullion - Panic Rated	CR907	\$725.00
Up to 8'0"	Steel Mullion - Panic Rated	CR908	\$735.00
Up to 10'0" (ED5200, ED5200S only)	Steel Mullion - Panic Rated	CR910	\$875.00
Up to 7'0"	Steel Mullion - 3 Hour Fire Rated	CR907A	\$1,008.00
Up to 8'0"	Steel Mullion - 3 Hour Fire Rated	CR908A	\$1,018.00
Up to 7'0"	Steel Mullion - 3 Hour Fire Rated, Windstorm Certified	CRFE707A ¹	\$1,257.00
Up to 8'0"	Steel Mullion - 3 Hour Fire Rated, Windstorm Certified	CRFE708A ¹	\$1,267.00

Key Removable Mullions

Door Height	Description	Specify	Price
Up to 7'0"	Steel Mullion - 1-1/2 Hour Fire Rated	CR907BKM ²	\$1,552.00
Up to 8'0"	Steel Mullion - 1-1/2 Hour Fire Rated	CR908BKM ²	\$1,562.00
Up to 10'0" (ED5200, ED5200S only)	Steel Mullion - Panic Rated	CR910KM ²	\$1,372.00
Up to 7'0"	Steel Mullion - 3 Hour Fire Rated, Windstorm Certified	CRWS707AKM ²	\$1,763.00
Up to 8'0"	Steel Mullion - 3 Hour Fire Rated, Windstorm Certified	CRWS708AKM ²	\$1,773.00

Notes:

- For use with UL approved door assemblies that comply to FEMA 361 and FEMA 320 guidelines. For the latest listings on compliant door assemblies visit our website at corbinrusswin.com
- Cylinder and collars not included, specify separately

Mullions Cylinder Options

Description	Specify	Add or Deduct
Conventional 6-pin	6P	Add \$93.00 per cylinder
Conventional 7-pin	7P	Add \$95.00 per cylinder
IC 6-pin	C6	Add \$173.00 per cylinder
IC 7-pin	C7	Add \$177.00 per cylinder
Pyramid High Security Fixed Core	PHS	Add \$189.00 per cylinder
Pyramid Security Fixed Core	PS	Add \$157.00 per cylinder
Pyramid High Security IC	PCHS	Add \$264.00 per cylinder
Pyramid Security IC	PCS	Add \$233.00 per cylinder
Security	HS	Add \$214.00 per cylinder
Security IC	CHS	Add \$292.00 per cylinder
IC 6-pin with temporary construction core (Red)	CT6R	Add \$173.00 per cylinder
IC 6-pin with temporary construction core (Blue)	CT6B	Add \$173.00 per cylinder
IC 6-pin with temporary construction core (Green)	CT6G	Add \$173.00 per cylinder
IC 6-pin with temporary disposable core	CT6D	Add \$93.00 per cylinder
IC 6-pin less core	CL6	Add \$93.00 per cylinder
IC 7-pin with temporary construction core (Red)	CT7R	Add \$177.00 per cylinder
IC 7-pin with temporary construction core (Blue)	CT7B	Add \$177.00 per cylinder
IC 7-pin with temporary construction core (Green)	CT7G	Add \$177.00 per cylinder
IC 7-pin with temporary disposable core	CT7D	Add \$95.00 per cylinder
IC 7-pin less core	CL7	Add \$95.00 per cylinder

Options

Description	Specify	Add or Deduct
Door frame filler block for double rabbetted frames	M95	Add \$42.00 per mullion
Door frame angle bracket for aluminum frames	M96	Add \$42.00 per mullion
Mullion stabilizer	M57	Add \$63.00 per mullion

Standard Features

Handing

Handed, specify hand

Door Thickness

1-3/4"

Backset

2-3/4"

Projection

4-7/8"; 3-1/8" depressed

Trim

Cylinder is not included.
See page 303 for
cylinder options.

Rim

ED7200

Panic

Vertical Rod

ED7400

Panic

Concealed Vertical Rod

ED7800

Panic

ED7800A

3 Hour Fire Rated

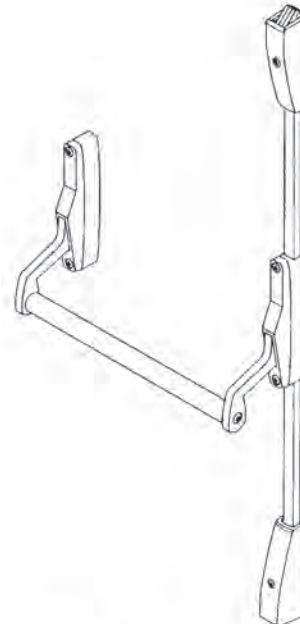
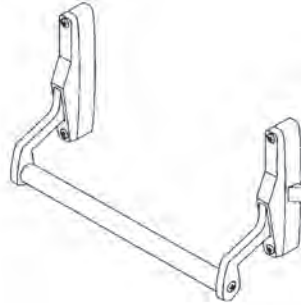

Ordering Example

Rim Exit Device

Quantity	Exit Device	Finish	Hand	Misc. Options
20	ED7200	606	RHR	M51-M54

Rim Exit Device with Trim

Quantity	Exit Device	Trim/Function	Finish	Hand	Door Thickness	Door Width	Misc. Options
50	ED7200	P557ET	630	LHR	D214	W048	M53

Trim Only (Rim Device)

Quantity	Exit Device	Finish
10	P457ET	630

Vertical Rod Exit Device with Trim

Quantity	Exit Device	Trim/Function	Finish	Hand	Door Thickness	Door Width	Misc. Options
50	ED7401	C455ET	613	RHR	D214	W048	H1000

Contract/Detailed Order - Rim Exit Device with Trim

Quantity	Keyset	Exit Device	Trim/Function	Finish	Hand	Door Thickness	Door Width	Optional Cylinders	Keying
50	AA1	ED7200	P457ET	626	LHR	D200	W048	C6	VKC3

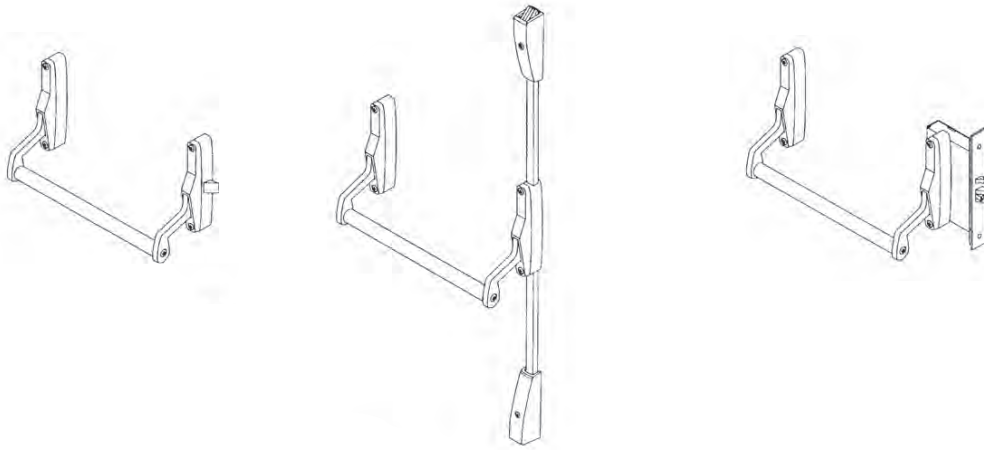

36" Device Only

Includes device, strike(s) and screw pack. No cylinder or trim.

Rim ED7200 Series

Function	Description	Finish: 613E, 626	Finish: 605, 606, 611, 612, 613, 618, 619, 625, 629, 630, 722
ED7200	Panic	\$3,009.00	\$3,086.00

Vertical Rod ED7400 Series

Function	Description	Finish: 613E, 626	Finish: 605, 606, 611, 612, 613, 618, 619, 625, 629, 630, 722
ED7400	Panic Exit Trim Only (accepts operator trim)	\$3,455.00	\$3,532.00
ED7401	Panic Exit Trim Only (accepts lever trim)		

Concealed V.R. ED7800 Series

Function	Description	Finish: 613E, 626	Finish: 605, 606, 611, 612, 613, 618, 619, 625, 629, 630, 722
ED7800	Panic	\$3,345.00	\$3,422.00
ED7800A	3 Hour Fire Rated	\$3,515.00	\$3,592.00

Caution: Be sure of your measurements. Exit devices are NOT returnable.

ED7200 Rim Trim

Cylinder is not included.

Pull Trim Design: P4 D Grip Pull



Grip: Extruded

Escutcheon: Wrought



Function	Description	Finish: 605, 606, 611, 612, 613, 613E, 618, 619, 625, 626, 629, 630, 722
P450ET	Dummy	\$424.00
P457ET	Nightlatch	

Pull Trim Design: P5 Round Grip Pull



Grip: Extruded

Escutcheon: Wrought



Function	Description	Finish: 605, 606, 611, 612, 613, 613E, 618, 619, 625, 626, 629, 630, 722
P550ET	Dummy	\$424.00
P557ET	Nightlatch	

Pull Trim Design: P6 Pull



Grip: Wrought
MR option available

Escutcheon: Wrought



Function	Description	Finish: 605, 606, 611, 612, 613, 613E, 618, 619, 625, 626, 629, 630, 722
P650ET	Dummy	\$424.00
P657ET	Nightlatch	

Pull Trim Design: P7 Plate

Escutcheon: Wrought
MR option available



Function	Description	Finish: 605, 606, 611, 612, 613, 613E, 618, 619, 625, 626, 629, 630, 722
P757ET	Nightlatch	\$416.00

ED7400 Surface Vertical Rod Trim

Cylinder is not included.

Escutcheon Trim Design: C4 Citation



Lever: Cast
MR option available

Escutcheon: Wrought
Available with ED7401 device only.



Function	Description	Finish: 605, 606, 611, 612, 613, 613E, 618, 619, 625, 626, 629, 630, 722
C455ET*	Classroom	\$867.00
C457ET*	Nightlatch	

*1-3/4 doors only

Escutcheon Trim Design: D4 Dirke



Lever: Cast
MR option available

Escutcheon: Wrought
Available with ED7401 device only.

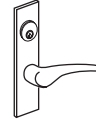

Function	Description	Finish: 605, 606, 611, 612, 613, 613E, 618, 619, 625, 626, 629, 630, 722
D455ET*	Classroom	\$867.00
D457ET*	Nightlatch	

*1-3/4 doors only

Escutcheon Trim Design: O3 D Grip Operator



Pull: Extruded
MR option available

Escutcheon: Cast
Available with ED7400 only.



Function	Description	Finish: 605, 606, 611, 612, 613, 613E, 618, 619, 625, 626, 629, 630, 722
O355ET	Classroom	\$867.00
O356ET**	Nightlatch	
O357ET	Nightlatch	

Escutcheon Trim Design: O4 Round Grip Operator



Pull: Extruded
MR option available

Escutcheon: Cast
Available with ED7400 only.



Function	Description	Finish: 605, 606, 611, 612, 613, 613E, 618, 619, 625, 626, 629, 630, 722
O455ET	Classroom	\$867.00
O456ET**	Nightlatch	
O457ET	Nightlatch	

**Key also used to hold top and bottom latchbolts in retracted position.

ED7800 Concealed Vertical Rod Trim

Cylinder is not included.

Trim Design: O5 Operator

Escutcheon: Cast



Function	Description	Finish: 605, 606, 611, 612, 613, 613E, 618, 619, 625, 626, 629, 630, 722
O557ET	Nightlatch	\$330.00

Offset Pull Trim: P12, P13, P14

Offset Pull Trim	Part Number	Finish: 605, 606, 612, 613, 613E, 626, 629, 630
P12	716F50M X Finish	\$304.00
P13	716F51M X Finish	\$370.00
P14	716F52M X Finish	\$261.00

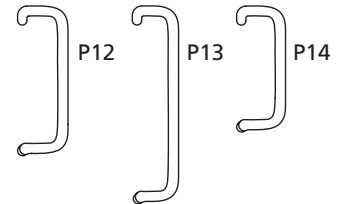

Cylinder Options

Description	Specify	Add or Deduct
Conventional 6-pin ⁷	6P*	Add \$93.00 per cylinder
Conventional 7-pin ⁷	7P	Add \$95.00 per cylinder
Access 3 Patented	AP	Add \$93.00 per cylinder
Access 3 Security	AS	Add \$142.00 per cylinder
Access 3 High Security, UL 437	AHS	Add \$162.00 per cylinder
Access 3 IC Patented	ACP	Add \$173.00 per cylinder
Access 3 IC Security	ACS	Add \$222.00 per cylinder
Access 3 IC High Security, UL 437	ACHS	Add \$242.00 per cylinder
Pyramid Security fixed core ^{1, 5, 6}	PS	Add \$157.00 per cylinder
Pyramid Security IC ^{2, 6}	PCS	Add \$233.00 per cylinder
Pyramid High Security fixed core ^{1, 5, 6}	PHS	Add \$189.00 per cylinder
Pyramid High Security IC ^{2, 6}	PCHS	Add \$264.00 per cylinder
Pyramid IC with temporary construction core ^{2, 6}	CTP	Add \$173.00 per cylinder
Pyramid IC with temporary disposable core ^{1, 3, 6}	CTPD	Add \$93.00 per cylinder
Pyramid IC less core ^{2, 6}	CLP	Add \$93.00 per cylinder
Security ¹	HS	Add \$214.00 per cylinder
Security IC ²	CHS	Add \$292.00 per cylinder
IC 6-pin ²	C6	Add \$173.00 per cylinder
IC 6-pin with temporary construction core ² (Red)	CT6R	Add \$173.00 per cylinder
IC 6-pin with temporary construction core ² (Blue)	CT6B	Add \$173.00 per cylinder
IC 6-pin with temporary construction core ² (Green)	CT6G	Add \$173.00 per cylinder
IC 6-pin with temporary disposable core ²	CT6D	Add \$93.00 per cylinder
IC 6-pin less core ²	CL6	Add \$93.00 per cylinder
SFIC 6-pin with Less Core	CLS6	Add \$93.00 per cylinder
IC 6-pin with SFIC disposable temporary core	CT6SD	Add \$93.00 per cylinder
IC 7-pin ³	C7	Add \$177.00 per cylinder
IC 7-pin with temporary construction core ³ (Red)	CT7R	Add \$177.00 per cylinder
IC 7-pin with temporary construction core ³ (Blue)	CT7B	Add \$177.00 per cylinder
IC 7-pin with temporary construction core ³ (Green)	CT7G	Add \$177.00 per cylinder
IC 7-pin with temporary disposable core ³	CT7D	Add \$95.00 per cylinder
IC 7-pin less core ³	CL7	Add \$95.00 per cylinder
SFIC 7-pin with Less Core	CLS7	Add \$95.00 per cylinder
IC 7-pin with SFIC disposable temporary core	CT7SD	Add \$95.00 per cylinder
Less master ring cylinder ⁴	MR-LC	No Charge
Master Ring ⁴	MR	Add \$144.00 per cylinder

*6P cylinder option is supplied in 6-pin, L4 keyway, 0-bitted with two nickel silver keys.

Notes:

- | | | |
|------------------------------------|----------------------------------------------------------|--------------------------------------------------------------------------|
| 1. Available on outside trim only. | 4. Available on C4, D4, OBS, O3, O4 trims only. | 6. Pyramid is not available on ED7600 with door thicknesses over 2-1/4". |
| 2. Not available on O5 trim. | 5. Not available on ED7600 C4M, D4M, E4M B5M, G6M trims. | 7. Not available on P4, P5, P5, P7 trims. |
| 3. Rim only. | | |

Keying Options

Description	Specify	Add or Deduct
0-Bitted with 2 blank keys	(standard)	No Charge
Keyed Random	KR	No Charge
Master Keyed (all cylinders except 8000, 8020, 8027 IC core)	specify keyset	Add \$16.00 per cylinder
Master Keyed Pyramid	specify keyset	Add \$16.00 per cylinder
Master Keyed Security (including IC cylinder and core)	specify keyset	Add \$16.00 per cylinder
Master Keyed (8000, 8020, 8027 IC core)	specify keyset	No Charge
Master Keyed to customer bittings or sample key	specify keyset	Add \$16.00 per cylinder
Construction master keyed ^{1,2}	CMK	Add \$16.00 per cylinder
Visual key control (VKC)		
- No Stamping	VKC0	\$4.50
- Keys only	VKC1	No Charge
- Cylinders and Keys ³	VKC2	\$8.00
- Cylinders only ³	VKC3	\$8.00
Concealed key control (CKC)		
- CKC cylinders with VKC keys	CKC2	\$8.00
- CKC cylinders only ³	CKC3	\$8.00
More than 2 keys per lock	KY# (e.g., KY6)	See page 31 - Cut Keys Section

- Notes:
1. CMK Construction master keying charge is in addition to master keying charge.
 2. CMK Construction master keying is not available in interchangeable core, Access 3, Pyramid, or Security series.
 3. VKC2, VKC3, CKC3 are not available in Pyramid or Security series.

Strike Options

To purchase strike separately, see catalog for part no.

Description	Specify	Add or Deduct
Open rim strike on ED7200	(standard)	No Charge
Rim strike	S07	
Rim strike for aluminum frames with blade stops	S08	
Mortised adjustable rim strike	S04	
Vertical rod top strike on ED7400 device	(standard)	
Vertical rod bottom strike on ED7400		
Vertical rod flush bottom strike on ED7400 device	S03	
Concealed vertical rod top strike on ED7800 device	(standard)	
Fire rated concealed vertical rod top strike on ED7800A device	(standard)	
Fire rated concealed vertical rod bottom strike on ED7800 and ED7800A devices	(standard)	

Description	Lip Length	Specify	Add or Deduct
Mortise straight lip ANSI strike on ED7600, ED7600A	1-1/8"	(standard)	No Charge
	1-1/4"	SS114	
	1-3/8"	SS138	
Mortise open back strike	1-3/4"	SB134	Add \$87.00 per device
	2"	SB200	\$140.00
	2-1/4"	SB214	

Custom Laser Engraving- LASER

Laser engraving processing charge (all engraving types)

- \$250 net per order. Charge will be applied to production order when placed.

Single Vanity, Logo or Other (same engraving on all parts)

- Lever - \$10 net add each
- Mortise Escutcheon - \$10 net add each
- HPSK Paddle - \$10 net add each

Unique laser engraving (i.e. Room Number, Apartment Number, etc)

- \$12 net add each (per piece)

Door Width Options		
Description	Specify	Add or Deduct
36"	(standard)	No Charge
48"	W048	Add \$37.00 per device
Door Thickness Options		
Description	Specify	Add or Deduct
1-3/4"	(standard)	No Charge
2" (Not available for ED7800 Series)	D200	
2-1/4" (Not available for ED7800 Series)	D214	
Door Height Options		
Description	Specify	Add or Deduct
7'6" (ED7400 devices)	(standard)	No Charge
7'2" (ED7400A & 7800A devices)	(standard)	
8'6" (ED7800 devices)	(standard)	
10'0" (ED7400 devices only)	H1000	Add \$87.00 per device
10'8" (ED7800 devices only)	H1008	
Miscellaneous Options		
Description	Specify	Add or Deduct
Spanner head screws	M02	Add \$36.00 per device
ANSI wrought strike box (for mortise only)	M17	No Charge
Knurling outside and inside (trim and device)	M20	Add \$153.00 per device
Knurling outside only (trim side)	M21	Add \$72.00 per device
Knurling inside only (device side)	M22	Add \$81.00 per device
Abrasive coat outside and inside (trim and device)	M23	Add \$97.00 per device
Abrasive coat inside only (device side)	M24	Add \$51.00 per device
Abrasive coat outside only (trim side)	M25	Add \$46.00 per device
Stainless steel crossbar ¹		
- When ordered with 626 or 630 finish	M50	No Charge
- All other finishes	M50	Add \$78.00 per device
Less dogging	M51	No Charge
Steel reinforced crossbar	M53	Add \$72.00 per device
Sex nuts and bolts (SNBs)	M54	No Charge
Shim for 2-3/4" backset on doors with 1/2" stop (for ED7200 only)	M59	Add \$23.00 per device
Less latch hold-back (for ED7200 and ED7600 devices only)	M66	No Charge
Note: 1. Not available with M22 or M20 option.		

Removable Mullion

Ordering Example

Quantity	Mullion Number
10	CR507

Mullion Number	Description	Price
CR507	For doors up to 7'2"	\$730.00
CR508	For doors up to 8'0"	\$1,018.00
CR510	For doors up to 10'	\$875.00

Standard Features

Handing

ED8200 Non-handed
ED8400 Handed; specify hand

Door Thickness

1-3/4"

Backset

2-3/4"

Bar Length

36 standard; 30", 42" and 48"
available. Easily field cut to
size.

Projection

2-1/2"

Trim

Cylinder is not included.
See page 313 for
cylinder options.

RIM

ED8200 Panic
ED8200B 1-1/2 Hour Fire Rated
ED8200A 3 Hour Fire Rated

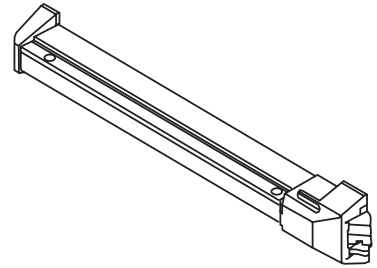

VERTICAL ROD

ED8400 Panic
ED8400A 3 Hour Fire Rated

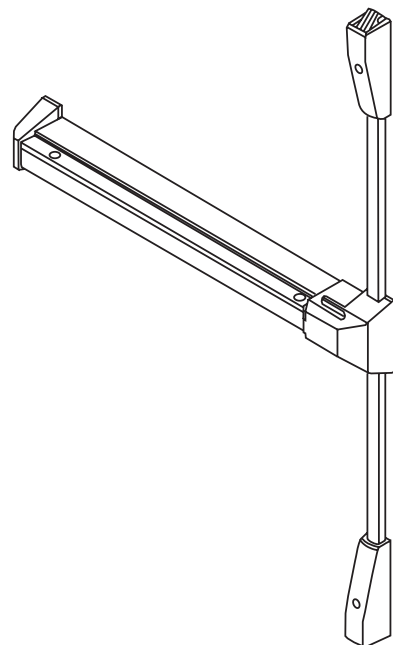

Ordering Example
Rim Exit Device

Quantity	Exit Device	Finish
20	ED8200	689

Rim Exit Device with Trim

Quantity	Exit Device	Trim/Function	Finish		Hand	Door Thickness	Door Width	Misc. Options
			Trim	Device				
50	ED8200A	A657ET	613	690	RHR	D200	W048	M58

Trim Only (Rim or Vertical Rod)

Quantity	Trim/Function	Finish	Hand
10	N655ET	606	RHR

Vertical Rod Exit Device with Trim

Quantity	Exit Device	Trim/Function	Finish		Hand	Optional Strike	Door Width	Height
			Trim	Device				
50	ED8400	PR610ET	626	689	RHR	S03	W048	H1000

Contract/Detailed Order - Rim Exit Device with Trim

Quantity	Keyset	Exit Device	Trim/Function	Finish		Hand	Door Thickness	Door Width	Optional Cylinder	Keying
				Trim	Device					
50	AA1	ED8200	N655ET	626	689	LHR	D200	W048	C6	VKC3

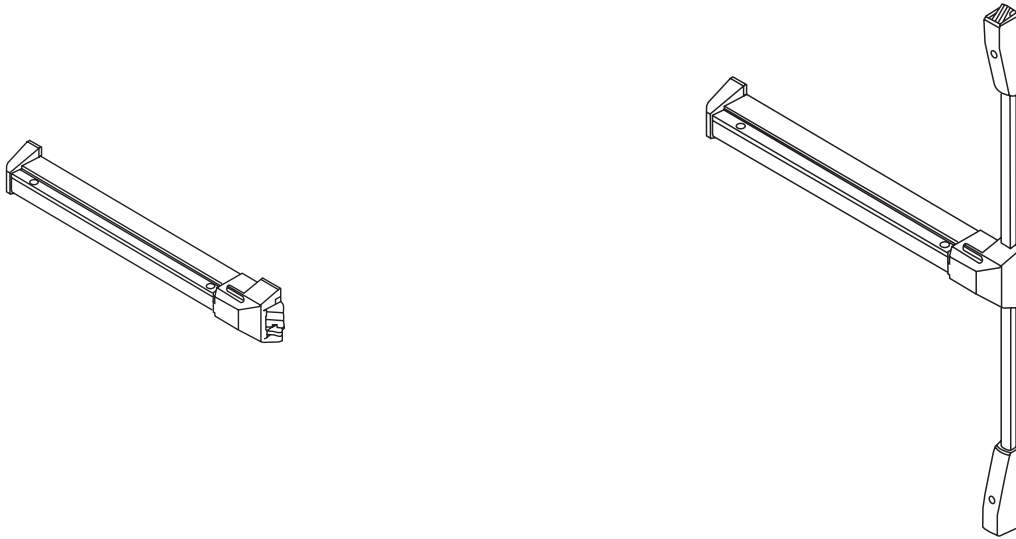

30", 36" and 42" Exit Devices

Includes device, strike(s) and screw pack. No cylinder or trim.

Rim ED8200 Series

Function	Description	Finish: 689, 690, 691
ED8200	Panic	\$558.00
ED8200B	1-1/2 Hour Fire Rated	\$630.00
ED8200A	3 Hour Fire Rated	\$711.00

Vertical Rod ED8400 Series

Function	Description	Finish: 689, 690, 691
ED8400	Panic	\$978.00
ED8400A	3 Hour Fire Rated	\$1,131.00

Caution: Be sure of your measurements. Exit devices are NOT returnable.

ED8200/ED8400 Rim and Vertical Rod Trim

Cylinder is not included, except where noted.

Rose Trim Design: A6 Armstrong



Lever: Die cast zinc
Cylinder included

Rose: Wrought brass or bronze



Function	Description	Finish: 605, 606, 611, 612, 613, 613E, 619, 625, 626, 722 BSP
A610ET	Passage	\$331.00
A650ET	Dummy	\$331.00
A655ET	Classroom	\$357.00
A657ET	Nightlatch ¹	
A659ET	Storeroom	

Rose Trim Design: N6 Newport



Lever: Die cast zinc
Cylinder included

Rose: Wrought brass or bronze

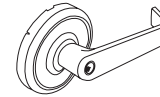

Function	Description	Finish: 605, 606, 611, 612, 613, 613E, 619, 625, 626, 722 BSP
N610ET	Passage	\$331.00
N650ET	Dummy	\$331.00
N655ET	Classroom	\$357.00
N657ET	Nightlatch ¹	
N659ET	Storeroom	

Rose Trim Design: PR6 Princeton



Lever: Die cast zinc
Cylinder included

Rose: Wrought brass or bronze

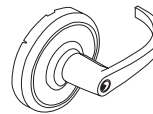

Function	Description	Finish: 605, 606, 611, 612, 613, 613E, 619, 625, 626, 722 BSP
PR610ET	Passage	\$331.00
PR650ET	Dummy	\$331.00
PR655ET	Classroom	\$357.00
PR657ET	Nightlatch ¹	
PR659ET	Storeroom	

Note:

1. Not recommended for use with ED8400 and ED8400A surface vertical rod exit devices.

ED8200/ED8400 Rim and Vertical Rod Trim

Cylinder is not included, except where noted.

Rose Trim Design: G10 Global

Knob: Wrought bronze
Cylinder included

Rose: Wrought brass or

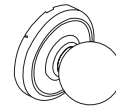

Function	Description	Finish: 605, 606, 611, 612, 613, 613E, 619, 625, 626, 722 BSP
G1010ET	Passage	\$311.00
G1055ET	Classroom	\$337.00
G1050ET	Dummy	\$311.00
G1057ET	Nightlatch ¹	\$337.00
G1059ET	Storeroom	\$337.00

Flat Plate Trim Design: F1 Flat Plate

Plate: Steel

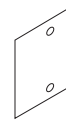

Function	Description	Finish: 605, 606, 611, 612, 613, 613E, 619, 625, 626, 722 BSP
F150ET	Dummy	\$93.00
F157ET	Nightlatch ¹	

Pull Trim Design: P1 Z-Pull



Pull: Extruded Aluminum



Function	Description	Finish: 605, 606, 611, 612, 613, 613E, 619, 625, 626, 722 BSP
P150ET	Dummy	\$269.00

Note:

1. Not recommended for use with ED8400 and ED8400A surface vertical rod exit devices.

ED8200/ED8400 Rim and Vertical Rod Trim

Cylinder is not included, except where noted.

Pull Trim Design: P2 Offset Pull



Pull: Extruded Aluminum



Function	Description	Finish: 605, 606, 611, 612, 613, 613E, 619, 625, 626, 722 BSP
P250ET	Dummy	\$309.00
P257ET	Nightlatch ¹	

Pull Trim Design: P8 Wing Pull



Pull: Extruded Aluminum

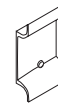

Function	Description	Finish: 689, 690, 691
P850ET	Dummy	\$88.00
P857ET	Nightlatch ¹	

Trim Design: KO Key Only

Note: Available with cylinder option only.
Example: KO57 x 6P



Function	Description	Finish: 605, 606, 611, 612, 613, 619, 622, 625, 626, 722
KO57ET	Nightlatch ¹	\$58.00

Offset Pull Trim: P12, P13, P14

Offset Pull Trim	Part Number	Finish: 605, 606, 611, 612, 613, 613E, 619, 625, 626, 722 BSP
P12	716F50M X Finish	\$304.00
P13	716F51M X Finish	\$370.00
P14	716F52M X Finish	\$261.00

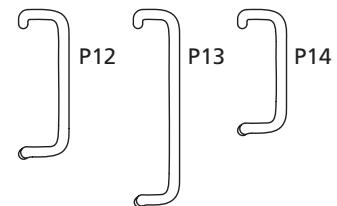

Note:

1. Not recommended for use with ED8400 and ED8400A surface vertical rod exit devices.

Cylinder Options*
Rim Cylinder Trim

Description	Specify	Add or Deduct
Conventional 6-pin	6P**	Add \$93.00 per cylinder
Conventional 7-pin	7P	Add \$95.00 per cylinder
Access 3 Patented	AP	Add \$93.00 per cylinder
Access 3 Security	AS	Add \$142.00 per cylinder
Access 3 High Security, UL 437	AHS	Add \$162.00 per cylinder
Access 3 IC Patented	ACP	Add \$173.00 per cylinder
Access 3 IC Security	ACS	Add \$222.00 per cylinder
Access 3 IC High Security, UL 437	ACHS	Add \$242.00 per cylinder
Pyramid Security fixed core	PS	Add \$157.00 per cylinder
Pyramid Security IC	PCS	Add \$233.00 per cylinder
Pyramid High Security fixed core	PHS	Add \$189.00 per cylinder
Pyramid High Security IC	PCHS	Add \$264.00 per cylinder
Pyramid IC with temporary construction core	CTP	Add \$173.00 per cylinder
Pyramid IC with temporary disposable core	CTPD	Add \$93.00 per cylinder
Pyramid IC less core	CLP	Add \$93.00 per cylinder
Security	HS	Add \$214.00 per cylinder
Security IC	CHS	Add \$292.00 per cylinder
IC 6-pin	C6	Add \$173.00 per cylinder
IC 6-pin with temporary construction core (Red)	CT6R	Add \$173.00 per cylinder
IC 6-pin with temporary construction core (Blue)	CT6B	Add \$173.00 per cylinder
IC 6-pin with temporary construction core (Green)	CT6G	Add \$173.00 per cylinder
IC 6-Pin with temporary disposable core	CT6D	Add \$93.00 per cylinder
IC 6-pin less core	CL6***	Add \$93.00 per cylinder
SFIC 6-pin with Less Core	CLS6	Add \$93.00 per cylinder
IC 6-pin with SFIC disposable temporary core	CT6SD	Add \$93.00 per cylinder
IC 7-pin	C7	Add \$177.00 per cylinder
IC 7-pin with temporary construction core (Red)	CT7R	Add \$177.00 per cylinder
IC 7-pin with temporary construction core (Blue)	CT7B	Add \$177.00 per cylinder
IC 7-pin with temporary construction core (Green)	CT7G	Add \$177.00 per cylinder
IC 7-Pin with temporary disposable core	CT7D	Add \$95.00 per cylinder
IC 7-pin less core	CL7	Add \$95.00 per cylinder
SFIC 7-pin with Less Core	CLS7	Add \$95.00 per cylinder
IC 7-pin with SFIC disposable temporary core	CT7SD	Add \$95.00 per cylinder

Knob and Lever Trim

Description	Specify	Add or Deduct
Conventional 6-pin	6P**	No Charge
Conventional 7-pin	7P	Add \$2.00 per cylinder
Access 3 Patented	AP	No Charge
Access 3 Security	AS	Add \$61.00 per cylinder
Access 3 High Security, UL 437	AHS	Add \$86.00 per cylinder
Access 3 IC Patented	ACP	Add \$80.00 per cylinder
Access 3 IC Security	ACS	Add \$132.00 per cylinder
Access 3 IC High Security, UL 437	ACHS	Add \$153.00 per cylinder
Pyramid Security fixed core	PS	Add \$64.00 per cylinder
Pyramid Security IC	PCS	Add \$140.00 per cylinder
Pyramid High Security fixed core	PHS	Add \$94.00 per cylinder
Pyramid High Security IC	PCHS	Add \$171.00 per cylinder
Security	HS	Add \$119.00 per cylinder
Security IC	CHS	Add \$199.00 per cylinder
IC 6-pin	C6	Add \$80.00 per cylinder
IC 6-pin with temporary construction core (Red)	CT6R	Add \$80.00 per cylinder
IC 6-pin with temporary construction core (Blue)	CT6B	Add \$80.00 per cylinder
IC 6-pin with temporary construction core (Green)	CT6G	Add \$80.00 per cylinder
IC 6-pin with temporary disposable core	CT6D	No Charge
IC 6-pin less core	CL6	No Charge
IC 7-pin	C7	Add \$82.00 per cylinder
IC 7-pin with temporary construction core (Red)	CT7R	Add \$82.00 per cylinder
IC 7-pin with temporary construction core (Blue)	CT7B	Add \$82.00 per cylinder
IC 7-pin with temporary construction core (Green)	CT7G	Add \$82.00 per cylinder
IC 7-pin with temporary disposable core	CT7D	No Charge
IC 7-pin less core	CL7	No Charge
Less (1) cylinder	LC	Deduct \$93.00 per cylinder

*Optional alarm unit cylinder and trim are keyed alike unless otherwise specified. If different keying is required, specify outside cylinder, then inside cylinder.

**6P cylinder option is supplied in 6-pin, L4 keyway, 0-bitted with two nickel silver keys.

*** Not available for G10 trim

Keying Options*

Description	Specify	Add or Deduct
0-Bitted with 2 blank keys	(standard)	No Charge
Keyed random	KR	No Charge
Master Keyed (all cylinders except (8000, 8020, 8027 IC core)	specify keyset	Add \$16.00 per cylinder
Master Keyed Pyramid	specify keyset	Add \$16.00 per cylinder
Master Keyed Security (including IC cylinder and core)	specify keyset	Add \$16.00 per cylinder
Master Keyed 8000, 8020, 8027 IC core	specify keyset	No Charge
Master Keyed to customer bittings or sample key	specify keyset	Add \$16.00 per cylinder
Construction master keyed ^{1,2}	CMK	Add \$16.00 per cylinder
Visual key control (VKC)		
- No Stamping	VKC0	\$4.50
- Keys only	VKC1	No Charge
- Cylinders and Keys ³	VKC2	\$8.00
- Cylinders only ³	VKC3	\$8.00
Concealed key control (CKC)		
- CKC cylinders with VKC keys	CKC2	\$8.00
- CKC cylinders only ³	CKC3	\$8.00
More than 2 keys per lock	KY# (e.g., KY6)	See page 31 - Cut Keys Section

Notes:

1. CMK Construction master keying charge is in addition to master keying charge.
2. CMK construction master keying is not available in interchangeable core, Access 3, Pyramid, or Security series.
3. VKC2, VKC3, CKC3 are not available in Pyramid or Security series.

*For key bows other than 10 and 90, specify 'KB' + bow number as Quick Code, e.g. KB12. No extra charge.

Door Width Options

Door Width	Specify	Add or Deduct
36"	(standard)	No Charge
30"	W030	
42"	W042	
48"	W048	Add \$37.00 per device

Door Thickness Options

Door Thickness	Specify	Add or Deduct
1-3/8" (G10, A6, N6, PR6 Trim only)	D138	No Charge
1-3/4"	(standard)	
2"	D200	
2-1/4"	D214	

Door Height Options

Door Height	Specify	Add or Deduct
7'6" (ED8400 devices)	(standard)	No Charge
8'0" (ED8400A devices)	(standard)	
10'0" (ED8400 devices only)	H1000	

Miscellaneous Options

Description	Specify	Add or Deduct
Less cylinder with tailpiece for Schlage® cylinder (A6, N6, PR6 designs only)	M06	No Charge
Lever to accept 6- or 7-pin Best-type IC core (SFIC) (N6, PR6 design only)	M08	No Charge
Lever to accept Sargent® cylinder (N6, PR6 design only)	M09	
Lever to accept <i>Schlage</i> IC core (N6, PR6 design only)	M69	
Knurling outside only (trim side)	M21	Add \$75.00 per lockset
Abrasive coat outside and inside (trim and device)	M23	Add \$92.00 per lockset
Abrasive coat inside only (device side)	M24	Add \$47.00 per lockset
Abrasive coat outside only (trim side)	M25	Add \$47.00 per lockset
Less dogging	M51	No Charge
Sex nuts and bolts (SNBs) ¹	M54	No Charge
Mullion Stabilizer	M57	Add \$63.00 per mullion
Shim kit (for vision light)		
- Rim device	M58	Add \$63.00 to device
- Vertical Rod device	M58	Add \$112.00 to device
Shim for 2-3/4" backset on doors with 1/2" stop	M59	Add \$30.00 to device

Note:

1. Not available with D138 option.

Strike Options*

Description	Specify	Add or Deduct
Rim strike on ED8200, ED8200B devices	(standard)	No Charge
Fire rated Rim strike on ED8200A devices		
Rim x Vertical Rod strike for pairs of doors	S02	Add \$37.00 to device
Vertical Rod top strike on ED8400 device	(standard)	No Charge
Vertical Rod surface projecting bottom strike on ED8400 device		
Vertical Rod flush bottom strike on ED8400 device	S03	No Charge
Fire rated Vertical Rod top strike on ED8400A device	(standard)	No Charge
Fire rated Vertical Rod bottom strike on ED8400A device	(standard)	No Charge

*To purchase strike separately, see catalog or parts manual for part no.

Custom Laser Engraving- LASER
Laser engraving processing charge (all engraving types)

- \$250 net per order. Charge will be applied to production order when placed.

Single Vanity, Logo or Other (same engraving on all parts)

- Lever - \$10 net add each
- Mortise Escutcheon - \$10 net add each
- HPSK Paddle - \$10 net add each

Unique laser engraving (i.e. Room Number, Apartment Number, etc)

- \$12 net add each (per piece)

Removable Mullion (Cylinder not included)

Cylinder not included

Ordering Example

Quantity	Mullion Number
10	508

Door Height Options

Door Height	Specify	Price
Up to 8'0" 3 hour fire rated	CR508	\$1,018.00
Up to 7'2"	CR507	\$730.00
(SFIC) Up to 10'0" (ED8200 only)	CR510	\$875.00
Up to 7'0" Steel Mullion - Panic Rated	CR907	\$725.00
Up to 8'0" Steel Mullion - Panic Rated	CR908	\$735.00
Up to 10'0" (ED8200 only), Steel Mullion - Panic Rated	CR910	\$875.00
Up to 7'0", Steel Mullion - 3 Hour Fire Rated	CR907A	\$1,008.00
Up to 8'0", Steel Mullion - 3 Hour Fire Rated	CR908A	\$1,018.00

Options

Description	Specify	Price
Up to 7'0", key removable mullion, 1-1/2 Hour Fire Rated	CR907BKM ¹	\$1,552.00
Up to 8'0", key removable mullion, 1-1/2 Hour Fire Rated	CR908BKM ¹	\$1,562.00
Up to 10'0" (ED8200 only), key removable mullion, Panic Rated	CR910KM ¹	\$1,372.00
Door frame filler block for double rabbeted frames	M95	Add \$42.00 per mullion
Door frame angle bracket for aluminum frames	M96	Add \$42.00 per mullion

Note 1: Cylinder and collars not included, specify separately

Mullions Cylinder Options

Description	Specify	Add or Deduct
Conventional 6-pin	6P	Add \$93.00 per cylinder
Conventional 7-pin	7P	Add \$95.00 per cylinder
IC 6-pin	C6	Add \$173.00 per cylinder
IC 7-pin	C7	Add \$177.00 per cylinder
Pyramid High Security Fixed Core	PHS	Add \$189.00 per cylinder
Pyramid Security Fixed Core	PS	Add \$157.00 per cylinder
Pyramid High Security IC	PCHS	Add \$264.00 per cylinder
Pyramid Security IC	PCS	Add \$233.00 per cylinder
Security	HS	Add \$214.00 per cylinder
Security IC	CHS	Add \$292.00 per cylinder
IC 6-pin with temporary construction core (Red)	CT6R	Add \$173.00 per cylinder
IC 6-pin with temporary construction core (Blue)	CT6B	Add \$173.00 per cylinder
IC 6-pin with temporary construction core (Green)	CT6G	Add \$173.00 per cylinder
IC 6-Pin with temporary disposable core	CT6D	Add \$93.00 per cylinder
IC 6-pin less core	CL6	Add \$93.00 per cylinder
IC 7-pin with temporary construction core (Red)	CT7R	Add \$177.00 per cylinder
IC 7-pin with temporary construction core (Blue)	CT7B	Add \$177.00 per cylinder
IC 7-pin with temporary construction core (Green)	CT7G	Add \$177.00 per cylinder
IC 7-Pin with temporary disposable core	CT7D	Add \$95.00 per cylinder
IC 7-pin less core	CL7	Add \$95.00 per cylinder

DC3000 Series:

DC3000 Series Standard Features	324
DC3000 Series Arm Options, Miscellaneous Options, Brackets, Door Thickness, Drop Plates, Finish Options	325

DC5000 Series (Cam Action Door Closer):

DC5000 Series Standard Features	326
DC5000 Series Arm Options, Door Thickness, Handing, Finish Options, Miscellaneous Options, Drop Plate	327

DC6000 Series:

DC6000 Series Standard Features	328
DC6200 Series, DC6400 Series	329
DC6000 Series Arm Options, Door Width Options, Finish Options, Door Thickness, Handing	330
DC6000 Series Miscellaneous Options, Blade Stop Spacer, Miscellaneous Brackets, Drop Plates	331

DC8000 Series:

DC8000 Series Standard Features	332
DC8200 Series (Factory Pre-Sized)	333
DC8000 Series Arm Options, Door Width Options, Finish Options	334
DC8000 Series Miscellaneous Options, Blade Stop Spacer, Miscellaneous Brackets	335
DC8000 Series Drop Plates	336

DC46900 Series:

DC46900 Series Safeguard™ Door Controls: Ordering Example, DC46900 Series, Voltage	337
------------------------------------------------------------------------------------	-----

DC62900 Series:

DC62900 Series Electromechanical Door Controls: Ordering Example, DC62900 Series, Miscellaneous Options, Voltage	338
------------------------------------------------------------------------------------------------------------------	-----

Standard Features

Handing

Non-handed

Spring Power

DC3200 Series: Non-sized
fully adjustable 1 thru 6.

Degree of Opening

Up to 180° opening standard for
regular, top jamb and
parallel arm mounting.

Case Quantity

4

Case Weight

42 lbs

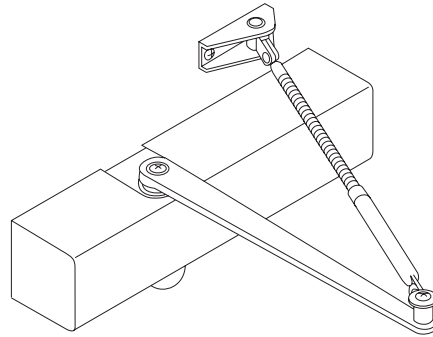

Ordering Examples

Stock Order

Quantity	Series/Mounting	Finish
48	DC3210	689

Contract Order

Quantity	Series/Mounting	Arm	Finish	Option
100	DC3210	A4	689	M54

DC3200 Series

Non-sized: full adjustability from sizes 1-6

Function	Description	Finish: 600, 689, 690, 691, 693, 696
DC3200	Regular arm	\$422.00
DC3210	Parallel arm	
DC3220	Top jamb	

DC3210 closers are tri-packed standard (for regular arm, top jamb or parallel arm mounting) unless specialty arm is requested.

Arm Options

Description	Specify Quick Code	Add or Deduct
Hold open arm	A1	Add \$74.00 per closer
Heavy-duty parallel arm with hold open	A2	Add \$95.00 per closer
Heavy-duty parallel arm	A3	Add \$47.00 per closer
Heavy-duty parallel arm with backstop	A4	Add \$89.00 per closer
Heavy-duty parallel arm with backstop & hold open	A5	Add \$167.00 per closer
Heavy-duty regular arm	A10	Add \$47.00 per closer

Miscellaneous Options

Description	Specify Quick Code	Add or Deduct
Sex nuts and bolts (SNB)	M54	No Charge
Backcheck intensity	(standard)	No Charge
Delayed Action	M71	Add \$44.00 per closer
Full ABS Cover	(standard)	No Charge
Corrosion protection	M75	Add \$42.00 per closer
Heavy-duty parallel arm flush transom bracket (499F30). Used with A2, A3, A4 & A5 arms)	M79	Add \$16.50 per closer

Miscellaneous Brackets

Description	Specify Quick Code	Add or Deduct
Parallel arm flush transom bracket	M82	Add \$31.00 per closer
Parallel arm offset bracket	M83	Add \$31.00 per closer
Mortise arm bracket for regular arm mounting	M84	Add \$31.00 per closer
Angle Support bracket	M85	Add \$31.00 per closer

Door Thickness

Description	Specify
1-3/4"	(standard)

Drop Plates

Closer Plates	Old Quick Ship #	Full Cover	List price
DC3210	M80	597F58	\$71.00
DC3220	M80	188F65	\$75.00

Finish Options

Description	Add or Deduct
600, 613E, 689, 690, 691, 693, 696, BSP, WSP	(standard)

Standard Features

Handing

Non-handed

Spring Power

DC5000 Series: sizes 1 thru 6 fully adjustable.

Degree of Opening

110° opening range for Push Side and Pull Side installations.

Slide Track

Standard

Case Weight

DC5230 8 lbs.
DC5240 8 lbs.



Ordering Example

Stock Order

Quantity	Series/Mounting	Finish
100	DC5230	689

Contract Order

Quantity	Series/Mounting	Arm	Finish
100	DC5240	A1	689

DC5000 Series

Non-sized: full adjustability from sizes 1-6

Function	Description	Finish: 689, 690, 691, 693, 696
DC5230	Pull Side Track	\$606.00
DC5240	Push Side Track	

Arm Options

Description	Specify Quick Code	Add or Deduct
Hold open arm	A1	\$28.00

Door Thickness

Description	Specify
1-3/4"	(standard)

Handing

Description	Specify
Left Hand	LH
Right Hand	RH
Left Hand Reverse	RH
Right Hand Reverse	LH

Finish Options

Description	Add or Deduct
Painted finishes: 689, 690, 691, 693, 696	(standard)

Miscellaneous Options

Description	Specify Quick Code	Add or Deduct
Sex nuts and bolts (SNB)	M54	No Charge

Drop Plate

Description	Part Number	Add or Deduct
Drop Plate (Push side)	754F80	\$51.00

Standard Features
Handing

Non-handed

Spring Power

DC6200 Series: sizes 1 thru 6 non-sized fully adjustable.
DC6400 Series: sizes 1 thru 6 half-size adjustability.

Degree of Opening

Up to full 180° opening standard for regular, top jamb and parallel arm applications.

Case Quantity

4

Case Weight

DC6200 42 lbs
DC6400 42 lbs



Ordering Example

Stock Order

Quantity	Series/Mounting	Finish
100	DC6210	689

Contract Order

Quantity	Series/Mounting	Arm	Finish	Door Thickness
100	DC6406	A6	689	D138

DC6200 Series

Non-sized: full adjustability from sizes 1-6

Function	Description	Finish: 600, 613E, 689, 690, 691, 693, 696, BSP, WSP
DC6200	Regular arm	\$464.00
DC6210	Parallel arm	
DC6220	Top jamb	
DC6230	Pull side track**	\$534.00
DC6240	Push side track	

DC6210 closers are tri-packed standard (for regular arm, top jamb or parallel arm mounting) unless specialty arm is requested.

**Minimum 3" top jamb required.

DC6400 Series

Sized: 1/2-size adjustability

Function	Description	Finish: 600, 613E, 689, 690, 691, 693, 696, BSP, WSP
DC6401	Regular arm	Size 1
DC6402		Size 2
DC6403		Size 3
DC6404		Size 4
DC6405		Size 5
DC6406		Size 6
DC6411	Parallel arm	Size 1
DC6412		Size 2
DC6413		Size 3
DC6414		Size 4
DC6415		Size 5
DC6416		Size 6
DC6421	Top jamb	Size 1
DC6422		Size 2
DC6423		Size 3
DC6424		Size 4
DC6425		Size 5
DC6426		Size 6
DC6433	Pull side track	Size 3
DC6434		Size 4
DC6435		Size 5
DC6436		Size 6
DC6443	Push side track	Size 3
DC6444		Size 4
DC6445		Size 5
DC6446		Size 6

Note: See page 323 for plated finishes.

DC641X closers are tri-packed standard (for regular arm, top jamb or parallel arm mounting) unless specialty arm is requested.

Arm Options

Description	Specify Quick Code	Add or Deduct
Hold open arm	A1	Add \$74.00 per closer
Heavy-duty parallel arm with hold open	A2	Add \$95.00 per closer
Heavy-duty parallel arm	A3	Add \$47.00 per closer
Heavy-duty parallel arm with backstop	A4	Add \$89.00 per closer
Heavy-duty parallel arm with backstop & hold open	A5	Add \$167.00 per closer
Deep reveal (3-1/4" - 7-1/4")	A6	No Charge
Deep reveal with hold open	A8	Add \$74.00 per closer
Heavy-duty regular arm	A10	Add \$47.00 per closer
Heavy-duty Unitrol®	A11*	Add \$241.00 per closer
Heavy-duty Unitrol® with hold open	A12*	Add \$317.00 per closer
Heavy-duty parallel arm with extra clearance	A13	Add \$39.00 per closer
Heavy-duty friction hold open arm	A14	Add \$94.00 per closer
Push side track with hold open	A1	Add \$74.00 per closer

* Specify door width

Door Width Options

Description	Specify Quick Code	Add or Deduct
A11, A12 door width 28" - 32"	W28	No Charge
A11, A12 door width 33" - 41"	W33	
A11, A12 door width 42" - 48"	W42	

Finish Options*

Description	Add or Deduct
	605, 606, 611, 612, 625, 626
Painted finishes: 600, 613E, 689, 690, 691, 693, 696, BSP, WSP	(standard)
Plated finishes: specify 605, 606, 611, 612, 625, 626	
Regular, parallel, hold open:	
- Plated arm & cover*	Add \$557.00 per closer
- Plated cover (metal)	Add \$227.00 per closer
- Plated arm*	Add \$330.00 per closer

Heavy-Duty arms (A2, A3, A4, A5, A10, A11, A12, A13, A14) are not available plated.

Track & arm for track-type closers are not available plated.

*For split finish of closer cover and arm, specify cover first, then arm finish; e.g. DC6200 x 625 x 689.

Special Finishes

<ul style="list-style-type: none"> Contact factory for availability A set-up fee will be added to EACH purchase order that lists non-standard sprayed or powder coat finishes 	Add \$832.00
Fee will appear as a separate line item on invoice SETUPDCG.	

Door Thickness

Description	Specify
1- 3/4"	(standard)
2"	D200

Handing

Description	Specify
Left Hand	LH
Right Hand	RH
Left Hand Reverse	RH
Right Hand Reverse	LH

Miscellaneous Options

Description	Specify Quick Code	Add or Deduct
Torx® Screws	M04	Add \$35.00 per closer
Sex nuts and bolts (SNB)	M54	No Charge
Backcheck intensity and location valves	(standard)	No Charge
Delayed Action	M71	Add \$44.00 per closer
Full ABS Cover	(standard)	No Charge
Full Metal Cover	M73	Add \$18.00 per closer
Extreme temperature fluid	(standard)	No Charge
Corrosion protection	M75	Add \$42.00 per closer
Security package*	M87	A2-Arm - Add \$137.00 per closer
		A3-Arm - Add \$90.00 per closer
		A4-Arm - Add \$131.00 per closer
		A5-Arm - Add \$209.00 per closer
		A10-Arm - Add \$90.00 per closer

*M87 includes full metal cover, Torx® fasteners and A2, A3, A4, A5, or A10 arm. Specify arm when ordering.

Blade Stop Spacer

Description	Specify Quick Code	Add or Deduct
1/2" spacer (597F92)	M77	Add \$23.00 per closer
5/8" spacer (597F93)	M78	Add \$38.00 per closer

Miscellaneous Brackets

Description	Specify Quick Code	Add or Deduct
HD PA flush transom bracket (used with all parallel arms except the Unitrol®)	M79	Add \$39.00 per closer
Parallel arm flush transom bracket	M82	Add \$31.00 per closer
Parallel arm offset bracket	M83	Add \$31.00 per closer
Mortise arm bracket for regular arm mounting	M84	Add \$31.00 per closer
Angle support bracket	M85	Add \$31.00 per closer
Deep Reveal Reinforcement Kit	M103	Add \$31.00 per closer
Flush partition bracket	M104	Add \$25.00 per closer
Lead lined cover (metal cover only)	M108	Add \$186.00 per closer

Drop Plates

Closer Plates	Old Quick Ship #	Full Cover	List Price
DC6210, DC6410 (Parallel)	M80	597F58	\$71.00
DC6220, DC6420 (Top Jamb)	M80	188F65	\$75.00
DC6230, DC6430 (Pull Side)	M81	597F59	\$75.00
DC6240, DC6440 (Push Side)	M102	597F59	\$75.00

Standard Features
Handing

Non-handed

Spring Power

DC8200 Series: sizes 1 thru 6
non-sized fully adjustable.

DC8200 Series: sizes 1 thru 6
half-size adjustability.

Degree of Opening

Up to full 180° opening
standard for regular, top jamb
and parallel arm applications.

Case Quantity

4

Case Weight

DC8200 54 lbs



Ordering Example

Stock Order

Quantity	Series/Mounting	Finish
100	DC8210	689

Contract Order

Quantity	Series/Mounting	Arm	Finish	Door Thickness
100	DC8206	A6	689	D138

DC8200 Series			
Non-sized full adjustability from sizes 1-6			
Function	Description		Finish: 600, 613E, 689, 690, 691, 693, 696, BSP, WSP
DC8200	Regular arm		\$599.00
DC8210	Parallel arm		
DC8220	Top Jamb		
DC8230	Pull side track**		\$664.00
DC8240	Push side track		
DC8210 closers are tri-packed standard (for regular arm, top jamb or parallel arm mounting) unless specialty arm is requested. *Minimum 3" top jamb required.			
Factory Pre-Sized (available upon request)			
Function	Description		Finish: 600, 613E, 689, 690, 691, 693, 696, BSP, WSP
DC8201	Regular arm	Size 1	\$599.00
DC8202		Size 2	
DC8203		Size 3	
DC8204		Size 4	
DC8205		Size 5	
DC8206		Size 6	
DC8211	Parallel arm	Size 1	
DC8212		Size 2	
DC8213		Size 3	
DC8214		Size 4	
DC8215		Size 5	
DC8216		Size 6	
DC8221	Top Jamb	Size 1	
DC8222		Size 2	
DC8223		Size 3	
DC8224		Size 4	
DC8225		Size 5	
DC8226		Size 6	
DC8233	Pull side track	Size 3	\$664.00
DC8234		Size 4	
DC8235		Size 5	
DC8236		Size 6	
DC8243	Push side track	Size 3	
DC8244		Size 4	
DC8245		Size 5	
DC8246		Size 6	
DC821X closers are tri-packed standard (for regular arm, top jamb or parallel arm mounting) unless specialty arm is requested.			

Arm Options

Description	Specify Quick Code	Add or Deduct
Hold open arm	A1	Add \$74.00 per closer
Heavy-duty parallel arm with hold open	A2	Add \$95.00 per closer
Heavy-duty parallel arm	A3	Add \$47.00 per closer
Heavy-duty parallel arm with backstop	A4	Add \$89.00 per closer
Heavy-duty parallel arm with backstop & hold open	A5	Add \$167.00 per closer
Deep reveal (3-1/4" - 7-1/4")	A6	No Charge
Deep reveal with hold open	A8	Add \$74.00 per closer
Heavy-duty regular arm	A10	Add \$47.00 per closer
Unitrol® arm	A11*	Add \$241.00 per closer
Unitrol arm x hold open	A12*	Add \$317.00 per closer
Heavy-duty parallel arm with extra clearance	A13	Add \$39.00 per closer
Heavy-duty friction hold open	A14	Add \$94.00 per closer
Push side track with hold open	A1	Add \$74.00 per closer

*Specify door width

Door Width Options

Description	Specify Quick Code	Add or Deduct
A11, A12 - door width 28" - 32"	W28	No Charge
A11, A12 - door width 33" - 41"	W33	
A11, A12 - door width 42" - 48"	W42	

Finish Options*

Description	Add or Deduct
	605, 606, 611, 612, 625, 626
Painted finishes: 600, 613E, 689, 690, 691, 693, 696, BSP, WSP	(standard)
Plated finishes: specify 605, 606, 611, 612, 625, 626	
Regular, parallel, hold open:	
- Plated arm & cover*	Add \$557.00 per closer
- Plated cover (metal)**	Add \$227.00 per closer
- Plated arm*	Add \$330.00 per closer

Heavy-Duty arms (A2, A3, A4, A5, A10, A11, A12, A13, A14) are not available plated.
 Track & arm for track-type closers are not available plated.

*For split finish of closer cover and arm, specify cover first, then arm finish; e.g. DC6200 x 625 x 689.

**Price of M73 option is not included.

Special Finishes

<ul style="list-style-type: none"> Contact factory for availability A set-up fee will be added to EACH purchase order that lists non-standard sprayed or powder coat finishes 	Add \$832.00
Fee will appear as a separate line item on invoice SETUPDCG.	

Miscellaneous Options		
Description	Specify Quick Code	Add or Deduct
Torx® Screws	M04	Add \$35.00 per closer
Sex nuts and bolts (SNB)	M54	No Charge
Backcheck valve	(standard)	No Charge
Delayed Action	M71	Add \$44.00 per closer
Full ABS Cover	(standard)	No Charge
Full Metal Cover	M73	Add \$18.00 per closer
Extreme Temperature Fluid	(standard)	No Charge
Corrosion Protection	M75	Add \$42.00 per closer
Security Package*	M87	A2-Arm - Add \$137.00 per closer
		A3-Arm - Add \$90.00 per closer
		A4-Arm - Add \$131.00 per closer
		A5-Arm - Add \$209.00 per closer
		A10-Arm - Add \$90.00 per closer
*M87 includes full metal cover, Torx® fasteners and A2, A3, A4, A5, A10 or A13. Specify arm when ordering		
Blade Stop Spacer		
Description	Specify Quick Code	Add or Deduct
1/2" spacer (597F92)	M77	Add \$23.00 per closer
5/8" spacer (597F93)	M78	Add \$38.00 per closer
Miscellaneous Brackets		
Description	Specify Quick Code	Add or Deduct
HD PA flush transom bracket (used with all parallel arms except the Unitrol®)	M79	Add \$39.00 per closer
Parallel arm flush transom bracket	M82	Add \$31.00 per closer
Parallel arm offset bracket	M83	Add \$31.00 per closer
Mortise arm bracket for regular arm mounting	M84	Add \$31.00 per closer
Angle support bracket	M85	Add \$31.00 per closer
Deep reveal reinforcement kit	M103	Add \$31.00 per closer
Flush partition bracket (used with Unitrol® arm)	M104	Add \$25.00 per closer
Lead lined cover	M108	Add \$183.00 per closer

Drop Plates

Closer Series	Part Number	List Price
DC8200 (regular)	754F20	\$92.00
DC8200 (with concealed holder)	754F24	\$92.00
DC8210 (parallel)	754F25	\$92.00
DC8220 (top jamb)	754F24	\$92.00
DC8230 (pull side track)	754F20	\$92.00
DC8240 (push side track)	754F25	\$92.00

Safeguard™ Door Controls

Non-sized closer.
689 and 690 Finishes.

Ordering Example

Quantity	Series/Mounting	Finish	Voltage
10	DC46920	689	24A

DC46900 Series

Model	Description	Price
DC46920	Pull side for RH and LH single doors and pair of doors	\$1,471.00
DC46925	Push side for LHR double egress doors	
DC46928	Pull side holder body with push side closer for reverse bevel doors	

Voltage

Description	Specify Quick Code
24VAC	24A
24VDC	24D
120VAC	120A

Electromechanical Door Controls

Sex nuts and bolts are furnished standard.
 689 Finish.

Ordering Example

Quantity	Series/Mounting	Finish	Voltage	Options
24	DC62930	689	24A	M54

DC62900 Series

Model	Quick Code	Description	Finish: 689, 690, 691, 693, 696
DC62930	ETD	Pull Side	Master Unit
DC62930	ET		Support Unit
DC62940	ETD	Push Side	Master Unit
DC62940	ET		Support Unit

Miscellaneous Options

Description	Specify Quick Code	Add or Deduct
Torx® machine screws	M04	Add \$36.00 per closer
Sex nuts and bolts		
- DC62930	(standard)	(standard)
- DC62940	(standard)	(standard)
Backcheck intensity valve	M70	Add \$36.00 per closer

Voltage*

Description	Specify Quick Code
24VAC	24A
24VDC	24D
120VAC	120A

Parts Price List

Number 34
USA & Canada Prices Effective
March 16, 2020



PLUGS AND SHELLS

6-PIN PLUGS, BULK PACKS

606, 626

PART NO.	DESCRIPTION	LIST PRICE
----------	-------------	------------

These packages are priced at a savings over individual plug prices. Keyway availability is limited to L4, D1, H1, 60, 59A1 and 981.

492K90	25 Pack for 1-1/8" Mortise	\$792.00
492K91	25 Pack for 3000 Rim	
492K92	50 Pack for CK4200, UT5200	\$1,585.00
610K48	50 Pack for CL3300	

5- AND 6-PIN INDIVIDUAL PLUGS

X CLASS	STANDARD	USED IN	LIST PRICE
---------	----------	---------	------------

487K10	121K10	1" Mortise (5-pin)	\$40.00
487K11	121K11	1-1/8" Mortise	
606K73	193K09	3-1/4" Mortise	\$71.00
606K74	193K10	3-1/2" Mortise	\$73.00
606K75	193K11	3-3/4" Mortise	\$76.00
487K38	197K51*	1001 Hotel Mortise	\$43.00
488K99	488K98	CK4200, UT5200 (.552") and 2000051	\$40.00
564K53	574K05	CK4400, except below	
564K60	564K52	CK4429 Hotel, old tailpiece	\$50.00
564K59	579K14	CK4429, new tailpiece	
580K99	574K07	CK4455, CK4482, before 8/93	\$40.00
596K29	585K24	CL3300, CL3500, CL3600, CL3700, CL3800	
596K31	585K26	CL3329, CL3629 Hotel	\$52.00
489K49	186K75	2001051 (1429/3433EM)	\$52.00
534K25	245K37	2100/2160 (large head)	\$50.00
612K90	444K87	2200001 and 009	
612K91	444K89	2200002	
612K88	444K94	2200008	
612K93	444K88	2200054	
612K94	523K21	2200076	\$40.00
488K84	253K66	3000 Rim Cylinder	
610K46	146K80	4200002 for AR Pull	\$50.00
	195K68	4266 for MR Exit Operators	\$61.00
334K01	334K00	80006 Interchangeable Core	\$40.00
n/a	378K18	Fox Police Rim Cyl. (5-pin)	\$61.00

7-PIN PLUGS

606, 626

X CLASS	STANDARD	USED IN	LIST PRICE
---------	----------	---------	------------

487K13	292K95	1-1/4" Mortise	\$43.00
487K15	292K96	1-3/8" Mortise	
487K17	292K97	1-1/2" Mortise	
487K19	292K98	1-3/4" Mortise	\$55.00
487K21	292K99	2" Mortise	\$60.00
606K76	293K00	2-1/4" Mortise	
606K77	293K01	2-1/2" Mortise	
606K78	293K02	2-3/4" Mortise	
606K79	293K03	3" Mortise	\$62.00
596K30	585K25	CL3300 Non-Hotel	\$51.00
596K32	585K27	CL3329 Hotel	\$55.00
488K85	253K67	3000-7 Rim Cylinder	\$43.00
416K08	416K07	8000-7 Core	\$51.00

SECURITY PLUGS (USE IN SECURITY SHELLS ONLY)

PART NO.	DESCRIPTION	LIST PRICE
----------	-------------	------------

407K63	1-1/8" Mortise	\$62.00
407K64	1-1/4" Mortise	
415K73	1-3/8" Mortise	\$68.00
415K74	1-1/2" Mortise	
518K73	1-3/4" Mortise	\$79.00
518K74	2" Mortise	\$82.00
518K75	2-1/4" Mortise	
518K76	2-1/2" Mortise	\$85.00
518K77	2-3/4" Mortise	
409K12*	1011 Mortise Hotel	\$62.00
408K45	CK4200, UT5200	\$55.00
585K46	CL3300 Non-Hotel	\$68.00
444K97	2210001 and 009	\$68.00
444K98	2210002	\$62.00
444K96	2210008	\$68.00
444K99	2210054	\$62.00
407K65	3010 Rim Cylinder	\$55.00
483K01	3012 Rim	\$66.00
446K68	8010 Interchangeable Core	\$51.00

PYRAMID STANDARD PLUGS

696K43	Used with 1020	†Order 10-	\$55.00
798K912 x Fin	Used with 1020112	†Order 10-	
696K45	Used with 3020	†Order 10-	
696K46	Used with 2020	†Order 10-	
696K48	Used with 2020	†Order 10-	
696K52	Used with 8020, 8027	†Order 10-	
715K14	Used with 2220	†Order 10-	\$55.00

PYRAMID SECURITY PLUGS

716K43	Used with 1027	†Order 10-	\$55.00
798K922 x Fin	Used with 1027112	†Order 10-	
716K45	Used with 3027	†Order 10-	
716K46	Used with 2027 KIL	†Order 10-	
716K48	Used with 2027 KIK	†Order 10-	
716K16	Used with 2227	†Order 10-	\$55.00

PYRAMID SIDE PIN PLUGS

628K852 x Fin	Used with 1020114	†Order 10-	\$55.00
628K972 x Fin	Used with 1020112	†Order 10-	
628K872 x Fin	Used with 3020	†Order 10-	
628K902 x Fin	Used with 2020052	†Order 10-	
628K882 x Fin	Used with 202003x	†Order 10-	\$55.00
628K952 x Fin	Used with 2220	†Order 10-	
629K032 x Fin	Used with 8020, 8027	†Order 10-	\$55.00
628K992 x Fin	Used with 1027114	†Order 10-	
630K472 x Fin	Used with 1027112	†Order 10-	
629K002 x Fin	Used with 3027	†Order 10-	
629K022 x Fin	Used with 2027052	†Order 10-	
629K012 x Fin	Used with 202703x	†Order 10-	\$55.00
629K042 x Fin	Used with 2227	†Order 10-	

6-PIN LOADED SHELLS, BULK PACKS

Finishes available for rim and mortise shells: 605, 606, 612, 613, 625, 626		
493F76	25 Pack for 1000118 Mortise	\$1,478.00
677F42	25 Pack for 1000114 Mortise	
493F77	25 Pack for 3000 Rim	
493F78	50 Pack for CK4200, UT5200	\$1,478.00
610F49	50 Pack for CL3300, CL3700	

*Not available in D1, D2, L1, L2, 752, 852 or A class keyways.
†Sold only in multiples of the number indicated. Price is each.

CYLINDER PARTS

PART NO.	DESCRIPTION	LIST PRICE	SOLD IN MULT. OF	PART NO.	DESCRIPTION	LIST PRICE	SOLD IN MULT. OF		
PYRAMID SHELLS				SECURITY MASTER PINS					
695F042 x Fin	Used with 1020114, 1027114, 3020058, 3027058	\$72.00	10†	407T314097	2L	\$5.30	20†		
695F052 x Fin	Used with 3020, 3027 (Slotted)								
696F502 x Fin	Used with 8020, 8027								
696F472	Used with 2020, 2027 (KIL))	\$64.00							
696F499	Used with 2020, 2027 (KIK)								
715F152	Used with 2220, 2227	\$64.00							
PYRAMID SHELLS - SIDE PINS				SECURITY TOP PINS					
628F922 x Fin	Used with 8020, 8027	\$64.00		1	407T434193	Size 1 Long	\$5.30	20†	
629F062 x Fin	Used with 1020114, 1027114, 3020058, 3027058								
630F482 x Fin	Used with 1020112, 1027112								
628F912	Used with 2020052, 2027052	\$64.00							
628F892	Used with 2020, 2027 (Levers)								
628F962	Used with 2220, 2227 (Competitors)	\$64.00							
629F072 x Fin	Used with 3020, 3027 (Slotted)	\$63.00							
PYRAMID SIDE PINS (VIAL OF 20 PINS)					BUMP-RESISTANT TOP SPOOL PINS (VIAL OF 100 PINS)				
630F494	Pyramid Side Pins - Vial Of 20 Pins	\$18.00	1		628F107171	Conventional	\$49.00	1	
PYRAMID HIGH SECURITY PINS (VIAL OF 100 PINS)					628F107142	Pyramid A	\$107.00	1	
TOP PINS				628F107236	Pyramid C	\$116.00	1		
695F257031 - .031"	695F257173 - .173"	\$50.00		1	SPRINGS AND SPRING COVERS				
695F257047 - .047"	695F257189 - .189"				792F997	Spring, interchangeable core	\$0.70	100†	
695F257063 - .063"	695F257204 - .204"				603F207	Spring, security and convent	\$0.30	100†	
695F257078 - .078"	695F257220 - .220"				026F757	Spring, hotel mortise blocking pin			
695F257094 - .094"	695F257236 - .236"				585F327	Spring, cylinder cap pin for 2000034 type	\$0.40	100†	
695F257110 - .110"	695F257252 - .252"				314F987	Spring for 2001034 indicator	\$0.30	100†	
695F257126 - .126"	695F257267 - .267"				217F422	Spring Cover, 5-pin brass	\$0.50	100†	
695F257141 - .141"	695F257283 - .283"		217F442		Spring Cover, 6-pin brass	\$0.50	100†		
695F257157 - .157"	695F257299 - .299"		314F887		Spring Cover, 6-pin stainless for most 2000 Series	\$0.70	50†		
BOTTOM PINS					217F432	Spring Cover, 7-pin brass	\$0.40	100†	
695F247139 - .139"	695F247218 - .218"	\$50.00	1	585F397	Spring Cover for 20000347	\$2.20	10†		
695F247155 - .155"	695F247234 - .234"			171F468	Spring for 1100 Series Cyl. Head	\$0.30	100†		
695F247171 - .171"	695F247250 - .250"			697F507	Spring for all Pyramid Cyls	\$0.30	100†		
695F247187 - .187"	695F247265 - .265"			ACCESS 3 PINS (VIAL OF 100 PINS)					
695F247202 - .202"	695F247281 - .281"			Bottom Pins (BP)					
PYRAMID SECURITY PINS (VIAL OF 100 PINS)				763F002213	Bottom AP-0	\$26.00	1		
TOP PINS				763F002243	Bottom AP-1				
695F252031 - .031"	695F252173 - .173"			\$50.00	1			763F002273	Bottom AP-2
695F252047 - .047"	695F252189 - .189"							763F002303	Bottom AP-3
695F252063 - .063"	695F252204 - .204"							763F002333	Bottom AP-4
695F252078 - .078"	695F252220 - .220"	763F002363	Bottom AP-5						
695F252094 - .094"	695F252236 - .236"	763F002393	Bottom AP-6						
695F252110 - .110"	695F252252 - .252"	Master Pins (MP)							
695F252126 - .126"	695F252267 - .267"	763F012030	Master AP&AS-1			\$26.00	1		
695F252141 - .141"	695F252283 - .283"	763F012060	Master AP&AS-2						
695F252157 - .157"	695F252299 - .299"	763F012090	Master AP&AS-3						
BOTTOM PINS								763F012120	Master AP&AS-4
695F244139 - .139"	695F244218 - .218"	763F012150	Master AP&AS-5						
695F244155 - .155"	695F244234 - .234"	Top Pin - Bump Resistant							
695F244171 - .171"	695F244250 - .250"	763F027120	Top-Spool AP-4	\$52.00	1				
695F244187 - .187"	695F244265 - .265"	763F027150	Top-Spool AP-5						
695F244202 - .202"	695F244281 - .281"	763F027180	Top-Spool AP-6						
PINS (SPECIFY SIZE WHERE APPROPRIATE)						763F027210	Top-Spool AP-7		
553F484 x length	Vial of 100 bottom pins (L Pins)	\$26.00	1			763F027240	Top-Spool AP-8		
553F502 x length	Vial of 100 spool top pins (J Pins)					763F027270	Top-Spool AP-9		
553F492 x length	Vial of 100 top pins (= master & Bu) (M Pins)					763F027300	Top-Spool AP-10		
546F978	Vial of 1500 construction balls	\$22.00	1	Top Pin					
197F527	Pin, blocking of 1001, 1011 (hotel)	\$2.20	50†	763F012180	Top AP-6	\$26.00	1		
SECURITY BOTTOM PINS				763F012210	Top AP/BU-7				
407T414242	2L	\$5.30	20†	763F012240	Top AP/BU-8				
407T424242	2R			763F012270	Top AP/BU-9				
407T414270	3L			Build Up Pins (BU)					
407T424270	3R			763F012300	BU-10	\$26.00	1		
407T414298	4L			763F012330	BU-11				
407T424298	4R			763F012360	BU-12				
407T414326	5L			CMK Wafer					
407T424326	5R			763F072	CMK Wafer	\$46.00	1		
407T414354	6L			†Sold only in multiples of the number indicated. Price is each.					
407T424354	6R			Copyright © 2002-2020 Corbin Russwin, Inc., an ASSA ABLOY Group company. All rights reserved. Reproduction in whole or in part without the express written permission of Corbin Russwin, Inc., is prohibited.					

CYLINDER PARTS (CONT'D)

PART NO.	DESCRIPTION	LIST PRICE	SOLD IN MULT. OF
CAMS – CONVENTIONAL AND SECURITY			
756F507	A01 Cloverleaf	\$6.40	10†
756F517	A02 Straight	\$6.40	10†
756F527	A03	\$6.40	10†
756F537	A04	\$6.40	10†
756F542	A05 AR4070	\$6.40	5†
756F557	A06	\$6.40	10
756F567	A07	\$7.50	10
756F582	A62	\$19.00	10
756F622	A92	\$5.30	10†
281F272	A93	\$9.60	10†
406F438	Cam for O5 Exit trim	\$13.00	1
CAMS - LFIC VERSION			
756F507	A01 Cloverleaf	\$6.40	10†
756F517	A02 Straight	\$6.40	
756F527	A03		
756F537	A04		
756F542	A05 AR4070		\$6.40
756F557	A06	\$6.40	10
756F567	A07	\$7.50	10
756F582	A62 Straight	\$19.00	10
756F622	A92	\$5.30	10
362F432	A93	\$9.60	10†
MASTER RING			
562F402	A61 New Cloverleaf (locks after 5/93)	\$5.30	10†
756F582	A62 Straight	\$19.00	10†
121F012	A63	\$5.30	5†
135F192	A64	\$8.50	5†
025F722	A65 Old Cloverleaf (was 11A)	\$6.40	5†
TAILPIECES			
444F748	A21	\$3.20	20†
461F108	A22	\$3.20	10†
520F358	A23	\$5.30	10†
444F758	A24	\$3.20	10†
365F968	A38 (Fox square)	\$4.30	5†
329F998	A39 (Fox round)	\$7.50	5†
484F958	A41	\$3.20	10†
484F928	A42		
484F918	A43	\$3.20	20†
484F968	A44	\$5.30	10†
484F938	A45	\$4.30	10†
484F948	A46	\$5.30	10†
146F788	A47	\$17.00	1
585F337	For 20010346	\$3.20	20†
585F358	For 20010347	\$4.30	10†
622F298	For 20000346	\$4.30	10†
596F898	For 2000038		
622F308	For 20000336, 20000347		
489F028	For 2000051	\$3.20	20†
682F298	For 20000337	\$3.20	20†
186F748	For 2001051	\$3.20	20†
622F328	For 2400033	\$7.50	1
682F398	For 2400034		
685F098	For 2400037		
616F208	For 2400039		
616F218	For 2400039L	\$8.50	1
490F558	For 3000138	\$4.30	10†
253F768	For 3000200	\$3.20	20†
413F488	For 3000200V	\$4.30	10†
253F778	For 3000312	\$3.20	20†
413F498	For 3000312V	\$4.30	10†
582F298	For 3080114 for exit alarm options M61 & M62	\$5.30	10†
253F858	For 3080178	\$5.30	10†
284F138	For 3080318	\$4.30	10†
599F389	Kit for Sargent® in CL3600	\$11.00	1
601F229	Kit for Sargent® in CL3400	\$12.00	1
622F328	For Schlage® cyl. in CL3400/CL3600	\$8.50	5†
715F108	P21	\$6.40	10†
715F118	P22		
715F128	P23		

PART NO.	DESCRIPTION	LIST PRICE	SOLD IN MULT. OF
RETAINERS			
173F798	.020" Plug Retainer-3300/5600,1400/4300	\$3.20	50†
368F918	.030" Plug Retainer-3000 and 3010 rim cylinders	\$3.20	20†
488F928	.032" Plug Retainer-2000052, 044 and 051	\$3.20	20†
333F998	Plug Retainer, LFIC, CK4400, 2200008, 2020 KIK	\$3.20	100†
334F238	Retainer, LFIC rim tailpiece	\$5.30	10†
365F958	Retainer, Fox Police rim cylinder	\$6.40	10†
250F088	Retainer for flex head cylinder	\$3.20	100†
680F645	Cap for 2000033, 034	\$5.30	10†
585F312	Cap Pin for 2000034	\$3.20	100†
219F888	Plug Retainer for 2060052	\$3.20	100†
LFIC THROW MEMBERS			
715F892	CK4200, UT5200	\$4.30	1
320F442	CK4200, UT5200 Best® knob	\$7.50	1
631F248	CL3400, CL3600 Series packet (before 6/2000) straight	\$5.30	10†
379F805	Used with 1030134, 1037134	\$46.00	1
628F825	Used with 1030114, 1037114, 1030138, 1037138, 3030, 3037	\$15.00	1
628F835	Used with 1030112, 1037112	\$18.00	1
362F153	Padlock	\$9.60	10†
OTHER LFIC PARTS			
353F868	Inner cam for 1071 (hotel)	\$9.60	5†
446F572	Control Sleeve for 8000 core	\$17.00	5†
446F582	Control Sleeve for 8010 core	\$20.00	5†
438F428	Mortise Cylinder Cam Screw	\$3.20	100†
334F128	Mortise Cylinder Cam Plate	\$3.20	20†
622F698	Security disk for CL3400, CL3600		
607F919	Spacer for 6-pin Best type core		
OTHER MASTER RING CYLINDER PARTS			
522F932	Adapter Bushing for MR	\$83.00	1
135F108	Backplate, MR rim	\$5.30	10†
158F062	Cam Spacer for A61, A62, A65	\$3.20	20†
700F575	Thumbturn Hub for A61 MR cam	\$37.00	1
562F422	Kit, A61 cam / hub conversion		
488F108	Mortise Cylinder Set Screw Pkt	\$3.20	20†
354F198	Thumbturn disk, A64 cam	\$98.00	1
197F357	Wave Washer for collar	\$5.30	10†
OTHER MORTISE/RIM CYLINDER PARTS			
253F758	Backplate, rim cylinder	\$3.20	20†
438F418	Cam Screw	\$3.20	100†
488F088	Mortise Cylinder Set Screw Pkt	\$3.20	20†
021F688	Screw, rim cyl. mounting, 2-9/32"	\$3.20	20†
021F718	Screw, rim cyl. mounting, 3-1/8"	\$5.30	10†
197F347	Wave Washer for collar	\$4.30	20†
129F848	Cylinder Nut	\$8.50	1
310F488	Thumbturn Disk, A02 cam	\$42.00	1
OTHER KNOB/LEVER CYLINDER PARTS			
596F879	Obsolete by new design		
585F387	2001034 Indicator fork	\$3.20	20†
585F377	2001034 Stabilizer Pin	\$3.20	20†
314F997	20010346 Indicator Pin	\$5.30	20†
585F407	20010347 Indicator Pin	\$8.50	1
585F367	Tailpiece Anchor, 2001034	\$3.20	20†
041F478	Key, hotel shut-out		50†
PYRAMID CYLINDER PARTS			
696F42	Blocking plate	\$5.30	20†
697F50	Tumbler spring	\$3.20	100†
217F43	Spring cover	\$3.20	100†
217F44	LFIC Spring cover	\$3.20	100†
696F51	Control sleeve	\$31.00	10†
628F932	Control sleeve - Used with 8020, 8027	\$33.00	10

†Sold only in multiples of the number indicated. Price is each.

STANDARD DIAMETER CYLINDER COLLARS

PART NO.	DESCRIPTION	LIST PRICE	SOLD IN MULT. OF
STAMPED COLLARS			
253F97	Spring collar 605, 606, 612, 613, 618, 619, 622, 625, 626	\$8.50	10†
428F66	2-Piece (was 574 1/2, H) 605, 606, 612, 613, 618, 619, 622, 625, 626	\$13.00	5† 1
549F52	.219" Straight (was 154 1/2, H1) 605, 606, 612, 613, 618, 619, 622, 625, 626	\$8.50	10†
605F43	.350 Tapered spring collar 605, 606, 612, 613, 618, 619, 622, 625, 626	\$8.50	
SPACER FOR FLEXIBLE HEAD CYLINDER			
370F29	.125" (1/8")	\$43.00	1
370F31	.250" (1/4")	\$43.00	1
252F82	.312" (5/16")	\$43.00	1
SOLID, RECESSED FOR CYLINDER HEAD			
447F41	.031" (was 575 1/4, 910) 605, 606, 612, 613, 618, 619, 622, 625, 626	\$20.00	1
270F15	.156" 605, 606, 612, 613, 618, 619, 622, 625, 626	\$27.00	1
447F42	.172" (was 575 3/8, 9106) 605, 606, 612, 613, 618, 619, 622, 625, 626	\$20.00	1
610F01	.221" (was 5574 3/4, C) 605, 606, 612, 613, 618, 619, 622, 625, 626	\$34.00	1
610F02	.289" (was 5574 1/4, L) 605, 606, 611, 612, 613, 618, 619, 625, 626	\$34.00	1
654F07	.356" for ED4000/ED5000 605, 606, 611, 612, 613, 622, 625, 626, 629, 630	\$27.00	1
447F43	.375" (was 575 9/16, 9109) 605, 606, 611, 612, 613, 618, 619, 625, 626	\$20.00	1
609F36	.500" 605, 606, 611, 612, 613, 618, 619, 625, 626	\$36.00	1

PART NO.	DESCRIPTION	LIST PRICE	SOLD IN MULT. OF
SOLID, RECESSED FOR CYLINDER HEAD (Cont'd)			
654F08	.556" for ED4000/ED5000 605, 606, 611, 612, 613, 622, 625, 626, 629, 630	\$27.00	1
609F37	.650" 605, 606, 611, 612, 613, 618, 619, 625, 626	\$38.00	1
609F38	.850" 605, 606, 611, 612, 613, 618, 619, 625, 626	\$38.00	1
134F05	With lip, .510" ED7400, ED7800 605, 606, 611, 612, 613, 618, 619, 622, 625, 626	\$38.00	1
267F97	With lip, .635" 605, 606, 611, 612, 613, 618, 619, 622, 625, 626	\$39.00	1
OTHER CYLINDER COLLARS			
416F39	Security .172" (was 95) 605, 606, 611, 612, 613, 618, 619, 625, 626	\$27.00	1
303F25	Solid .312" (was 571/J) 605, 606, 611, 612, 613, 618, 619, 625, 626	\$37.00	1
RIM CYLINDER COLLARS			
Flush Mount (was 151/ R1290)			
255F53	605, 606, 611, 612, 613, 618, 619, 622, 625, 626	\$20.00	10† 10† 1
Surface Mount			
422F88	605, 606, 611, 612, 613, 618, 619, 622, 626, 625	\$20.00	5† 1

†Sold only in multiples of the number indicated. Price is each.

MASTER RING CYLINDER COLLARS

PART NO.	DESCRIPTION	LIST PRICE	SOLD IN MULT. OF
SOLID, RECESSED FOR CYLINDER HEAD			
447F44	.031" (was 576 1/4, MR910)		1
	605, 606, 611, 612, 613, 618, 619, 625, 626	\$27.00	
447F45	.172" (was 576 3/8, MR9106)		1
	605, 606, 611, 612, 613, 618, 619, 625, 626	\$32.00	
447F46	.375" (was 576 9/16, MR9109)		1
	605, 606, 611, 612, 613, 618, 619, 625, 626	\$36.00	
SPACERS FOR FLEXIBLE HEAD CYLINDERS			
366F70	.090" tapered	\$13.00	5
370F33	.094"		
370F35	.281"	\$13.00	1
RIM CYLINDER COLLARS			
255F54	(was 151 3/4, T)		1
	605, 606, 612, 613, 619, 625, 626	\$20.00	

PART NO.	DESCRIPTION	LIST PRICE
CYLINDER SERVICE TOOLS		
See main price book		
LOCKSET INSTALLATION TOOLS		
574F158	CK4400 Series Knob Removal Tool	\$3.20
506F57	CK4400 Series Knob Cover Removal Tool	\$8.50
391F658	Knob Release Tool, CK4200, ML2200 †Order 100-	\$3.20

PART NO.	DESCRIPTION	LIST PRICE	PART NO.	DESCRIPTION	LIST PRICE
ARMORED FRONT			AUXILIARY LATCH		
Finish: 605, 606, 611, 612, 613, 619, 625, 626, 629**, 630**			403F677	Auxiliary latch	\$18.00
Deadbolt			AUXILIARY LATCH LEVER		
079F00	Armored front, 1-1/4" standard	\$39.00	678F548	Auxiliary latch lever	\$6.40
079F02	Armored front, 1-1/8"		Auxiliary Latch Lever Spring		
Deadbolt, latchbolt, aux. latch, toggle			678F677	Auxiliary latch lever spring. †Order 100-	\$3.20
402F29	Armored front, 1-1/4" standard	\$39.00	CAP		
402F33	Armored front, 1-1/8"		700F278	Cap	\$27.00
Deadbolt, latchbolt, auxiliary latch			CASE & FRONT SA		
402F30	Armored front, 1-1/4" standard	\$39.00	820F268 = 1-1/4" - STD		
402F34	Armored front, 1-1/8"		820F278 = 1-1/4" - ML2060/68		
Deadbolt, latchbolt, toggle			820F348 = 1-1/8" - STD		
402F31	Armored front, 1-1/4" standard	\$39.00	820F358 = 1-1/8" - ML2060/68		
402F35	Armored front, 1-1/8"		CYLINDER LATCH LEVER SA		
Latchbolt, auxiliary latch, toggle			701F748	Cylinder latch lever	\$3.20
681F31	Armored front, 1-1/4" standard	\$39.00	753F098	Cylinder latch lever (functions 72, 73, 75)	
681F30	Armored front, 1-1/8"		CYLINDER LATCH LEVER STOP		
681F41	LHB, 1-1/4"		705F949	Cylinder latch lever stop	\$3.20
681F40	LHB, 1-1/16"		CYLINDER SET SCREW BRACKET		
Blank Front			402F738	Cylinder set screw bracket	\$6.40
720F43	Armored front, 1-1/4"	\$39.00	DEADBOLT		
720F46	Armored front, 1-1/16"		702F987	Deadbolt	\$46.00
Filler Plate			753F697	Deadbolt ML2072	
334F998	USP Filler, 8" x 1-1/4"		DEADBOLT SPRING		
Deadbolt, latchbolt			701F228	Deadbolt spring †Order 50-	\$3.20
423F54	Armored front, 1-1/4" standard	\$39.00	DEADLOCKING LEVER		
423F57	Armored front, 1-1/8"		602F198	Toggle Functions	\$5.30
Latchbolt only			624F488	Non-Toggle Functions	
423F55	Armored front, 1-1/4" standard	\$39.00	DEADLOCKING LEVER SPRING		
423F58	Armored front, 1-1/8"		700F907	Deadlocking lever spring	\$3.20
Latchbolt, auxiliary latch			FIXED STOP		
624F49	Armored front, 1-1/4" standard	\$39.00	684F559	Fixed stop	\$5.30
624F53	Armored front, 1-1/8"		HUB ALIGNMENT BRACKET		
			404F868	Hub alignment bracket	\$7.50
			HUB ALIGNMENT BRACKET SCREW		
			269F088	FHUM-PH #8-32 X 3/8" Screw †Order 20-	\$3.20
			HUB LEVER		
			820F008	Non Panic Egress	\$6.40
			820F148	Panic Egress	

†Sold only in multiples of the number indicated. Price is each.
 **618, 619 finish provided to match 629, 630.

PART NO.	DESCRIPTION	LIST PRICE
HUB LEVER SPRING		
820F048	Hub lever spring †Order 10-	\$3.20
HUB SPACER		
684F119	Hub spacer	\$3.20
KNOB HUB		
820F088	Cap Side	\$23.00
820F168	Case Side	
LATCHBOLT		
688F177	Latchbolt	\$52.00
LATCH LEVER SPRING		
700F957	Latch lever spring	\$3.20
LEVER HUB		
820F068	Cap side	\$15.00
820F078	Case side	
LEVER RETURN SPRING		
404F858	Lever return spring †Order 20-	\$3.20
LOCKING LEVER		
852F307	ML2017 Locking Lever	\$26.00
852F318	ML2017 Spring	
OCCUPANCY INDICATOR, ML2029		
605, 606, 611, 612, 613, 618, 619, 625, 626		
416F84	1-3/4" door, sectional	\$92.00
429F08	1-3/8" door, sectional	\$92.00
484F74	2-1/4" door, sectional	\$92.00
416F49	Escutcheon trim - 1-3/4" door	\$70.00
RETAINING RING		
436F177	Retaining ring †Order 100-	\$3.20
SCREW PACKETS		
Finish: 606, 612, 613, 619		
429F41	Mounting screw pack, standard	\$5.30
488F09	Mounting screw pack, MR option	\$8.50
465F57	Mounting screw pack, M04 (VR)	\$27.00
616F12	Mounting screw pack, MR x M04	
SPACER		
466F229	Spacer	\$3.20
624F439	Spacer	
624F449	Spacer	
SPACER SPRING		
684F129	Spacer spring	\$2.20
SPRINGS		
403F568	Spring	\$9.60
688F017	Spring, kickoff	\$3.20
624F427	Spring	\$4.30

†Sold only in multiples of the number indicated. Price is each.

**618, 619 finish provided to match 629, 630

PART NO.	DESCRIPTION	LIST PRICE
STOP		
684F055	Stop	\$5.30
STOP LEVERS		
700F708	Stop lever	\$3.20
624F478	Stop lever	\$6.40
681F448	Stop lever	\$3.20
682F018	Stop lever	\$6.40
700F748	Stop lever	\$3.20
753F078	Stop lever	
STOP SCREW		
684F067	Stop screw	\$3.20
STOP SPRING		
685F387	Stop spring	\$3.20
703F997	Stop spring	\$3.20
790F047	Aux Stop Spring	
THUMBTURN LEVER HUB		
624F455	Thumbturn lever hub	\$9.60
TURNPIECE HUB – STANDARD		
813F505	Turnpiece Hub, Standard	\$4.30
TURNPIECE HUB – LARGE		
701F705	Turnpiece Hub, Large	\$8.50
853F865	Turnpiece hub, large (ML2087 RH/RHR)	
853F875	Turnpiece hub, large (ML2087 LH/LHR)	
STRIKES		
605, 606, 611, 612, 613, 619, 625, 626, 629**, 630**		
Latchbolt & Deadbolt - Straight Lip		
236L72M014FIN	7/8" Lip Length	\$38.00
236L72M016FIN	1" Lip Length	
236L72M018FIN	1-1/8" Lip Length	
236L72M020FIN	1-1/4" Lip Length	
236L72M022FIN	1-3/8" Lip Length	
236L72M024FIN	1-1/2" Lip Length	
236L72M028FIN	1-3/4" Lip Length	
236L72M032FIN	2" Lip Length	
236L72M036FIN	2-1/4" Lip Length	
236L72M040FIN	2-1/2" Lip Length	
236L72M044FIN	2-3/4" Lip Length	
236L72M048FIN	3" Lip Length	

PART NO.	DESCRIPTION	LIST PRICE
STRIKES (Cont'd)		
605, 606, 611, 612, 619, 613, 625, 626, 629**, 630**		
Latchbolt & Deadbolt - Curved Lip (RH)		
340L60M018FIN	1-1/8" Lip Length RH	\$38.00
340L60M020FIN	1-1/4" Lip Length RH	
340L60M022FIN	1-3/8" Lip Length RH	
340L60M024FIN	1-1/2" Lip Length RH	
340L60M028FIN	1-3/4" Lip Length RH	
340L60M032FIN	2" Lip Length RH	
340L60M036FIN	2-1/4" Lip Length RH	
340L60M040FIN	2-1/2" Lip Length RH	
340L60M044FIN	2-3/4" Lip Length RH	
340L60M048FIN	3" Lip Length RH	
Latchbolt & Deadbolt - Curved Lip (LH)		
340L61M018FIN	1-1/8" Lip Length LH	\$38.00
340L617020FIN	1-1/4" Lip Length LH	
340L61M022FIN	1-3/8" Lip Length LH	
340L61M024FIN	1-1/2" Lip Length LH	
340L61M028FIN	1-3/4" Lip Length LH	
340L61M032FIN	2" Lip Length LH	
340L61M036FIN	2-1/4" Lip Length LH	
340L61M040FIN	2-1/2" Lip Length LH	
340L61M044FIN	2-3/4" Lip Length LH	
340L61M048FIN	3" Lip Length LH	

PART NO.	DESCRIPTION	LIST PRICE
STRIKE - OPEN BACK		
605, 606, 611, 612, 613, 619, 625, 626, 629**, 630**		
411L63M016FIN	1-3/4" (016) Door RHR	\$122.00
411L63M018FIN	2" (018) Door LHR	
411L63M020FIN	2-1/4" (020) Door RHR	\$182.00
411L62M016FIN	1-3/4" (016) Door LHR	
411L62M018FIN	2" (018) Door RHR	
411L62M020FIN	2-1/4" (020) Door LHR	
STRIKE - RABBETED FRONT		
605, 606, 611, 612, 613, 619, 625, 626, 629**, 630**		
318F64	Latch RH/LHR	\$210.00
318F65	Deadbolt RH/LHR	
318F66	Latch and Deadbolt RH/LHR	
318F67	Latch LH/RHR	
318F68	Deadbolt LH/RHR	
318F69	Latch and Deadbolt LH/RHR	

†Sold only in multiples of the number indicated. Price is each.

**618, 619 finish provided to match 629, 630, except on 1-1/4" length curved lip strike

PART NO.	DESCRIPTION	LIST PRICE
TRIM ALIGNMENT (ADAPTER) PACKETS		
Finish: 605, 606, 611, 612, 613, 619, 625, 626, 629**, 630**		
"P" Escutcheon		
Knob or Lever Trim		
466F73	1-3/8" door	\$63.00
466F74	1-3/4" door	
466F75	2-1/4" door	\$71.00
Half Working Trim		
439F25	1-3/8" door	\$39.00
439F26	1-3/4" door	
439F27	2-1/4" door	
Lever/Knob (GZ/YZ) Half Dummy Trim		
488F31	"P" Escutcheon	\$80.00
Lever/Knob (GZ/YZ) Full Dummy Trim		
854F19	"P" Escutcheon	\$80.00
Knob Half Dummy Trim		
437F28	"P" Escutcheon*	\$80.00
Wrought Knob Half Dummy Trim		
511F52	"P" Escutcheon*	\$71.00
"M" and "N" Escutcheons		
Regularly Furnished with Working Trim		
466F50	1-3/8" door	\$61.00
466F51	1-3/4" door	\$61.00
466F52	2-1/4" door	\$61.00
Half Working Trim		
428F32	1-3/8" door	\$38.00
428F33	1-3/4" door	
428F34	2-1/4" door	
Half Dummy Trim		
437F26	Knob*	\$68.00
438F37	Cast Knob*	\$75.00
854F27	Lever/Knob (GZ/YZ)	\$68.00
Full Dummy Trim		
854F15	Lever/Knob (GZ/YZ)	\$68.00

†Sold only in multiples of the number indicated. Price is each.

**618, 619 finish provided to match 629, 630.

*Discontinued product, only available as inventory allows.

PART NO.	DESCRIPTION	LIST PRICE
TRIM ALIGNMENT (ADAPTER) PACKETS (Cont'd)		
Knob or Lever Trim Outside & Blank Escutcheon Inside		
466F45	1-3/8" door	\$46.00
466F46	1-3/4" door	
466F47	2-1/4" door	\$46.00
Sectional Trim		
Regularly Furnished with Working Trim		No Finish
466F40	1-3/8" door	\$31.00
466F41	1-3/4" door	\$31.00
466F42	2-1/4" door	\$31.00
Half Working Trim		
437F40	1-3/8" door	\$31.00
437F41	1-3/4" door	
437F42	2-1/4" door	
Half Dummy Trim		
438F38	Cast Knob*	\$78.00
854F23	Lever/Knob (GZ/YZ)	\$48.00
511F51	Wrought Knob*	\$61.00
Full Dummy Trim		
854F11	Lever/Knob (GZ/YZ)	\$16.00
Inside Adapter Only - Lockbody		
427F06	Knob Half Working Trim*	\$31.00
488F27	Lever/Knob (GZ/YZ) Half Working Trim	\$55.00
Adjustable Locknut Assembly*		No Finish
482F37	Adjustable Locknut Assembly	\$11.00
Adjusting Bolt for Half Lever Trim		No Finish
483F34	1-3/8" door	\$11.00
483F35	1-3/4" door	\$11.00
483F36	2-1/4" door	\$11.00
Cylinder Set Screw Packet		No Finish
488F088	Standard †Order 20	\$3.20
488F108	Master Ring	\$3.20
Dowel Screw		No Finish
483F30	for Inside Lever/Knob (GZ/YZ)	\$4.30
Emergency Key		Finish: 619
605F42	for ML2020, ML2030, ML2060	\$6.40
E-Ring		No Finish
427F078	for working half trim adapter. †Order 100-	\$3.20

PART NO.	DESCRIPTION	605, 606, 611, 612, 613, 613E, 618, 619, 625, 626, 629, 630, 722
"R" ESCUTCHEON - CAST		
Blank		
426F52	Outside	
545F79	Inside	
For Cylinder only		
427F45	Outside	
545F88	Inside	
For Grip only		
427F43	Outside	
545F87	Inside	
For Cylinder & Grip		
427F39	Outside	
545F80	Inside	
For Thumbturn Lever only		
545F84	Inside-1-3/8" door	\$247.00
545F86	Inside-2-1/4" door	
545F85	Inside-1-3/4" door	
For Thumbturn Lever & Grip		
545F81	Inside-1-3/8" door	
545F83	Inside-2-1/4" door	
545F82	Inside-1-3/4" door	
For Grip & Emergency Key		
427F47	Outside	
For Cylinder, Grip & Indicator		
427F37	Outside-1-3/4" door	
427F36	Outside-1-3/8" door	
485F74	Outside-2-1/4" door	
PART NO.	DESCRIPTION	605, 606, 611, 612, 613, 613E, 618, 619, 625, 626, 629, 630, 722
"N" ESCUTCHEON - WROUGHT		
Blank		
544F93	Inside or Outside	
For Cylinder only		
544F80	Inside or Outside	
For Grip only		
544F76	Inside or Outside	
For Cylinder & Grip		
544F77	Inside or Outside	
For Thumbturn Lever only		
544F89	Inside-1-3/4" door	
544F92	Inside-1-3/8" door	
544F91	Inside-2-1/4" door	\$137.00
For Thumbturn Lever & Grip		
544F85	Inside-1-3/4" door	
544F87	Inside-2-1/4" door	
544F88	Inside-1-3/8" door	
For Grip & Emergency Key		
544F79	Outside	
For Cylinder, Grip & Indicator		
544F82	Outside-1-3/8" door	
544F83	Outside-1-3/4" door	
544F84	Outside-2-1/4" door	

PART NO.	DESCRIPTION	605, 606, 611, 612, 613, 613E, 618, 619, 625, 626, 629, 630, 722
"M" ESCUTCHEON - WROUGHT		
Blank		
383F82	Outside	
545F45	Inside	
For Cylinder only		
488F07	Outside	
751F16	Outside - Master Ring	
545F00	Inside	
751F17	Inside - Master Ring	
For Grip only		
488F04	Outside	
544F95	Inside	
For Cylinder & Grip		
488F05	Outside - Conventional	
557F29	Outside - Master Ring	
544F96	Inside - Conventional	\$137.00
377F80	Inside - Master Ring	
For Thumbturn Lever only		
545F42	Inside-1-3/8" door	
545F43	Inside-1-3/4" door	
545F44	Inside-2-1/4" door	
For Thumbturn Lever & Grip		
544F97	Inside-1-3/8" door	
544F98	Inside-1-3/4" door	
544F99	Inside-2-1/4" door	
For Grip & Emergency Key		
544F94	Outside	
For Cylinder, Grip & Indicator		
433F48	Outside-1-3/8" door	
433F49	Outside-1-3/4" door	
484F90	Outside-2-1/4" door	
"P" ESCUTCHEON - WROUGHT		
Blank		
544F46	Inside	
384F11	Outside	\$137.00
For Cylinder only		
488F03	Outside	
544F43	Inside	

PART NO.	DESCRIPTION	605, 606, 611, 612, 613, 613E, 618, 619, 626, 625, 629, 630, 722
"P" ESCUTCHEON - WROUGHT		
For Grip only		
488F00	Outside	
544F39	Inside	
For Cylinder & Grip		
488F01	Outside	
544F40	Inside	
For Thumbturn Lever only		
544F14	Inside-1-3/8" door	
544F44	Inside-2-1/4" door	
544F45	Inside-1-3/4" door	
For Thumbturn Lever & Grp		
544F13	Inside-1-3/8" door	
544F41	Inside-2-1/4" door	
544F42	Inside-1-3/4" door	
For Grp & Emergency Key		
544F38	Outside	
For Cylinder, Grip & Indicator		
430F47	Outside-1-3/8" door	
435F00	Outside-1-3/4" door	
484F76	Outside-2-1/4" door	
		\$137.00

PART NO.	DESCRIPTION	613E, 630
"V" ESCUTCHEON - CAST		
Blank		
700F80	Outside	
700F40	Inside	
For Cylinder only		
700F83	Outside	
700F43	Inside	
For Grip only		
700F81	Outside	
700F41	Inside	
For Cylinder & Grip		
700F82	Outside	
700F87	Outside - 7P & C6 (Use when collar is required)	
700F42	Inside	
700F47	Inside - 7P & C6 (Use when collar is required)	
For Thumbturn Lever only		
700F45	Inside	
For Thumbturn Lever & Grip		
700F44	Inside	
For Grp & Emergency Key		
700F84	Outside	
For Cylinder, Grip & Indicator		
700F86	Outside	
700F46	Inside	
		\$279.00

PART NO.	DESCRIPTION	LIST PRICE
Hex Wrench		
		No Finish
264F698	Hex Wrench	\$3.20
Key Plate Packet		
438F90	Key Plate Packet: 605, 606, 611, 612, 613, 619, 625, 626, 629**, 630**	\$28.00

**618, 619 finish provided to match 629, 630.

PART NO.	DESCRIPTION	605, 606, 611, 612, 613, 613E, 625, 626	PART NO.	DESCRIPTION	605, 606, 611, 612, 613, 613E, 625, 626
"GZ" KNOB - CAST*			"YZ" KNOB - CAST*		
Inside Knob			Inside Knob		
854F04		\$201.00	854F09		\$201.00
Outside Knob & Spindle Assembly			Outside Knob & Spindle Assembly		
854F01	for 1-3/4" door	\$201.00	854F06	for 1-3/4" door	\$201.00
854F00	for 1-3/8" door		854F05	for 1-3/8" door	
854F03	for 2-1/4" door		854F08	for 2-1/4" door	

MISCELLANEOUS PARTS		
PART NO.	DESCRIPTION	LIST PRICE
Knob Release Tool		No Finish
391F658	Knob Release Tool	\$3.20
Knob Shank Adapter		No Finish
483F118	Knob Shank Adapter	\$8.50
Spring Clip		
377F308	Spring Clip	\$3.20

MORTISE INDICATOR PARTS		
PART NO.	DESCRIPTION	LIST PRICE
855F649	Indicator Mechanism Retaining Pad (sectional)	\$3.00
856F049	Indicator Window	
855F619	Indicator Spindle Cam - Thumbturn	\$13.00
855F707	Indicator Spindle Cam - Cylinder / No Input-Blank (Std door thickness)	
855F727	Indicator Spindle Cam - Cylinder / No Input-Blank - (other door thicknesses *must specify)	
855F747 x Finish	Indicator Spindle Cam - Coin Turn (Std door thickness)	
855F767 x Finish	Indicator Spindle Cam - Coin Turn (other door thicknesses *must specify)	
858F241	Indicator Display Assembly - Unlocked/Locked, Green/Red	\$75.00
858F251	Indicator Display Assembly - Vacant/Occupied, Green/Red	
858F261	Indicator Display Assembly - Unlocked Icon/Locked Icon, Green/Red	
858F271	Indicator Display Assembly - Unlocked/Locked, White/Red	
858F281	Indicator Display Assembly - Vacant/Occupied, White/Red	
858F291	Indicator Display Assembly - Unlocked Icon/Locked Icon, White/Red	
855F638	Escutcheon Indicator Backing Plate	\$14.00
855F658	Sectional Indicator Surface Mount Backing Plate	\$5.00
858F517 x Finish	Escutcheon Indicator Screw Pack - Phillips, 1-3/4" Door	\$9.00
858F50M FIN	Escutcheon Indicator Screw Pack - Phillips, 1-3/8" Door	
858F52M FIN	Escutcheon Indicator Screw Pack - Phillips, 2" Door	
858F53M FIN	Escutcheon Indicator Screw Pack - Phillips, 2-1/4" Door	
858F55M FIN	Escutcheon Indicator Screw Pack - Phillips, 2-1/2" Door	
858F497 x Finish	Sectional Indicator Screw Pack - Phillips & Torx	\$14.00
858F549	Sectional Indicator Template Kit	
55F592 x Finish	Cylinder Plate Only - ML190 (Cylinder not included)	\$92.00
855F582 x Finish	CoinTurn Plate Only - ML193 (Assembly that includes cointurn)	\$89.00
859F052 x Finish	Thumbturn Plate Only - ML194 (Assembly that includes standard thumbturn)	\$92.00
859F062 x Finish	Thumbturn Plate Only - ML194 (Assembly that includes ADA thumbturn)	\$108.00
859F072 x Finish	Thumbturn Plate Only - ML194 (Assembly that includes T1 thumbturn)	\$92.00
859F082 x Finish	Thumbturn Plate Only - ML194 (Assembly that includes T2 thumbturn)	
859F092 x Finish	Thumbturn Plate Only - ML194 (Assembly that includes T3 thumbturn)	
855F602 x Finish	Blank/No Input Plate Only - ML197	
855F697	Indicator Spindle Cam - Cylinder / No Input-Blank (1-3/8" door thickness)	\$13.00
855F717	Indicator Spindle Cam - Cylinder / No Input-Blank (2-1/4" door thickness)	
855F737 x Finish	Indicator Spindle Cam - Coin Turn (1-3/8" door thickness)	\$16.00
855F757 x Finish	Indicator Spindle Cam - Coin Turn (2-1/4" door thickness)	

PART NO.	DESCRIPTION	605, 606, 611, 612, 613, 613E, 618, 619, 625, 626, 629, 630, 722
"AS" LEVER - CAST		
Inside Lever		
670F37		
Outside Lever & Spindle Assembly		
670F64	for 1-3/8" door	\$216.00
670F73	for 1-3/4" door	
671F09	for 2-1/4" door	
"CS" LEVER - CAST		
Inside Lever		
670F30		
Outside Lever & Spindle Assembly		
670F57	for 1-3/8" door	\$216.00
670F66	for 1-3/4" door	
671F02	for 2-1/4" door	
"DS" LEVER - CAST		
Inside Lever		
670F32	LH/LHR	
670F31	RH/RHR	
Outside Lever & Spindle Assembly		
670F59	for 1-3/8" door	RH/RHR
670F68	for 1-3/4" door	RH/RHR
671F04	for 2-1/4" door	RH/RHR
670F58	for 1-3/8" door	LH/LHR
670F67	for 1-3/4" door	LH/LHR
671F03	for 2-1/4" door	LH/LHR
"ES" LEVER - CAST		
Inside Lever		
670F33		
Outside Lever & Spindle Assembly		
670F60	for 1-3/8" door	\$216.00
670F69	for 1-3/4" door	
671F05	for 2-1/4" door	
"LS" LEVER - CAST		
Inside Lever		
670F34		
Outside Lever & Spindle Assembly		
670F61	for 1-3/8" door	\$216.00
670F70	for 1-3/4" door	
671F06	for 2-1/4" door	
"NS" LEVER - CAST		
Inside Lever		
670F36		
Outside Lever & Spindle Assembly		
670F63	for 1-3/8" door	\$216.00
670F72	for 1-3/4" door	
671F08	for 2-1/4" door	
"PS" LEVER - CAST		
Inside Lever		
670F38		
Outside Lever & Spindle Assembly		
670F65	for 1-3/8" door	\$216.00
670F74	for 1-3/4" door	
671F10	for 2-1/4" door	
"RS" LEVER - CAST		
Inside Lever		
670F35		
Outside Lever & Spindle Assembly		
670F62	for 1-3/8" door	\$216.00
670F71	for 1-3/4" door	
671F07	for 2-1/4" door	

PART NO.	DESCRIPTION	605, 606, 611, 612, 613, 613E, 618, 619, 625, 626, 629, 630, 722
"LW" LEVER - WROUGHT		
Inside Lever		
493F31		\$182.00
Outside Lever & Spindle Assembly		
483F79	for 1-3/8" door	\$182.00
483F80	for 1-3/4" door	
483F81	for 2-1/4" door	
"RW" LEVER - WROUGHT		
Inside Lever		
493F34		\$182.00
Outside Lever & Spindle Assembly		
483F82	for 1-3/8" door	\$182.00
483F83	for 1-3/4" door	
483F84	for 2-1/4" door	

PART NO.	DESCRIPTION	LIST PRICE
NYLON BUSHING NO FINISH		
698F22	Nylon Bushing †Order 100-	\$3.20
ROSE PACKET		
Wrought Rose Packet- (Qty 2) 2-7/8" dia. (C)*		
445F82	605, 606, 611, 612, 613, 613E, 618, 619, 625, 626, 722	\$79.00
Wrought Rose Packet- (Qty 2) 3-1/2" dia. (D)*		
445F83	605, 606, 611, 612, 613, 613E, 618, 619, 625, 626, 722	\$79.00
Wrought Rose Packet- (Qty 2) 3" square (E)*		
445F84	605, 606, 611, 612, 613, 613E, 618, 619, 625, 626, 722	\$79.00
Cast Rose Packet - (Qty 2) 2-7/8" dia. (F)		
447F24	605, 606, 611, 612, 613E, 618, 619, 625, 626, 629, 630, 722	\$193.00
Cast Rose Packet- (Qty 2) 2-1/4" dia. (B)		
447F25	605, 606, 611, 612, 613E, 618, 619, 625, 626, 629, 630, 722	\$100.00
Wrought Rose Packet- (Qty 2) 2-1/4" dia. (A)		
487F08	605, 606, 611, 612, 613E, 618, 619, 625, 626, 629, 630, 722	\$79.00
Wrought Rose Packet- (Qty 2) 2-7/8" dia. (H)		
853F05	605, 606, 611, 612, 613E, 618, 619, 625, 626, 629, 630, 722	\$79.00

PART NO.	DESCRIPTION	LIST PRICE
ROSE REINFORCEMENT PACKET NO FINISH		
445F869	Rose Reinforcement Packet*	\$7.50
SCREW PACKET		
605, 606, 611, 612, 613, 619, 625, 626, 629, 630		
569F45	For M & P half dummy trim*	\$8.50
429F317	Screw Packet for "N" Surface Mounted Escutcheon	\$11.00
616F088	Lock mounting, spanner	\$11.00
584F46	Escutcheon for 1-3/4" door, spanner	\$6.40
384F03	Escutcheon for 2" - 2-1/4" door, spanner	
616F078	T20 Torx® bit	\$15.00
269F098	Screw 1-32 x 1/4" OHMS-PH †Order 100-	\$3.20
SPACER NO FINISH		
497F528	Spacer for Cast Knob*	\$4.30
SPINDLES NO FINISH		
LxL, KxK, LxK, KxL Spindle		
499F828	1-3/8" door	\$39.00
499F838	1-3/4" door	
499F848	2-1/4" door	

†Sold only in multiples of the number indicated. Price is each.

*Discontinued product, only available as inventory allows.

PART NO.	DESCRIPTION	LIST PRICE	PART NO.	DESCRIPTION	LIST PRICE
INSIDE SPINDLE FOR HALF LEVER TRIM*			ERGONOMIC THUMBTURN KIT FOR ESCUTCHEON TRIM		
	(Knob x Knob) Spindle*			605, 606, 611, 612, 613, 619, 625, 626, 629, 630	
680F348	1-3/8" door	\$20.00	711F002	for up to 4" door (must be field cut to size)	\$76.00
680F358	1-3/4" door	\$6.40	WASHER FOR VANDAL RESISTANT TRIM		
680F368	2-1/4" door	\$14.00	700F378	Washer	\$4.30
VANDAL RESISTANT SPINDLE & SCREW PACK			RETAINING RING FOR VANDAL RESISTANT TRIM		
700F65	1-3/4" door	\$18.00	700F168	Retaining ring	\$3.20
700F66	2" door		LEVER SPINDLE SPRING FOR VANDAL RESISTANT TRIM		
700F67	2 -1/4" door		700F367	Lever spindle spring	\$3.20
THIMBLE PACKET			M19 OPTION INDICATORS – KEYED FUNCTION (SECURE)		
432F86	(Qty 2) for wrought escutcheon knob trim designs*		PART NO. X FINISH	DESCRIPTION	605, 606, 611, 612, 613, 613E, 618, 619, 625, 626, 629, 630, 722
	605, 606, 611, 612, 613, 619, 625, 626, 629, 630	\$38.00			
445F85	(Qty 2) for sectional knob trim designs*				
	605, 606, 611, 612, 613, 619, 625, 626	\$47.00			
THIMBLE WRENCH NO FINISH			M19 OPTION INDICATORS – KEYED FUNCTION (VACANT)		
300F688	Thimble Wrench	\$4.80	720F21	for 1-3/8" (35mm) door	\$130.00
THROUGHBOLT PACKET			720F22	for 1-3/4" (44mm) – 2" (51mm) door	
	605, 606, 611, 612, 613, 619, 625, 626, 629, 630		720F24	for 2-1/4" (57mm) door	
	"M" and "P" Escutcheons		720F25	for over 2-1/4" (57mm) door	
433F76	1-3/8" door	\$8.50	M19 OPTION INDICATORS – KEYED FUNCTION (SECURE)		
433F77	1-3/4" door		741F21	for 1-3/8" door	\$130.00
433F78	2-1/4" door		741F22	for 1-3/4" to 2" doors	
"R" Escutcheon			741F23	for 2-1/4" door	
439F33	1-3/8" door	\$8.50	741F24	for up to 3" door	
439F34	1-3/4" door		M19 OPTION INDICATORS – NON-KEYED FUNCTION (SECURE)		
439F35	2-1/4" door		721F16	for 1-3/8" (35mm) door	\$127.00
"T" Escutcheon (spanner head)*			721F17	for 1-3/4" (44mm) – 2" (51mm) door	
445F318	1-3/4" door	\$17.00	721F18	for 2-1/4" (57mm) door	
498F928	2" to 2-1/4" door		721F19	for over 2-1/4" (57mm) door	
THUMBTURN LEVER PACKET			M19 OPTION INDICATORS – NON-KEYED FUNCTION (VACANT)		
	605, 606, 611, 612, 613, 625, 626, 629, 630		720F61	for 1-3/8" (35mm) door	\$127.00
519F09	for 1-3/8" door	\$52.00	720F62	for 1-3/4" (44mm) – 2" (51mm) door	
519F10	for 1-3/4" door		720F64	for 2-1/4" (57mm) door	
519F11	for 2-1/4" door		720F65	for over 2-1/4" (57mm) door	
519F12	for up to 3" door	\$67.00	M19 OPTION THUMBTURN INDICATOR		
581F96	for up to 3-1/2" door		723F69	for 1-3/8" (35mm) door	\$225.00
696F39	Blank Plate	\$67.00	723F26	for 1-3/4" (44mm) – 2" (51mm) door	
ERGONOMIC THUMBTURN LEVER PACKET FOR SECTIONAL TRIM			791F59	for 2-1/4" (57mm) door	
	605, 606, 611, 612, 613, 619, 625, 626, 629, 630		791F60	for over 2-1/4" (57mm) door	
707F57	for 1-3/8" door	\$76.00			
707F58	for 1-3/4" to 2" doors				
707F59	for 2-1/4" door				
707F60	for up to 3" door	\$76.00			
706F70	for up to 4" door				

*Discontinued product, only available as inventory allows.

VINEYARD™ COLLECTION TRIM

PART NO.	DESCRIPTION	605 , 606, 613E, 619, 625, 626
INSIDE LEVERS		
692F632	Frascati LH/LHR	\$284.00
692F642	Frascati RH/RHR	
692F662	Zinfandel LH/LHR	
692F672	Zinfandel RH/RHR	
692F652	Merlot	\$265.00
OUTSIDE LEVERS		
692F762	Frascati for 1 3/4" door LH/LHR	\$284.00
692F752	Frascati for 1 3/4" door RH/RHR	
692F952	Zinfandel for 1 3/4" door LH/LHR	
692F942	Zinfandel for 1 3/4" door RH/RHR	
692F932	Merlot for 1 3/4" door	\$265.00
L ESCUTCHEON - CAST		
Blank		
692F862	Inside	\$234.00
For Cylinder Only		
694F322	Inside	
694F522	Outside	
For Grip Only		
694F312	Inside	
694F442	Outside	
For Cylinder & Grip		
694F332	Inside	
694F562	Outside	
For Thumbturn Lever Only		
694F352	Inside	
For Thumbturn Lever & Grip		
694F392	Inside	
For Grip & Emergency Key		
694F482	Outside	
For Cylinder, Grip & Indicator		
694F602	Outside	
For Grip x Plug Only		
694F682	Outside	
For Grip x Plug Only x Indicator		
694F722	Outside	
ROSES (PAIR)		
694F802	G-Rose (All functions)	\$264.00

LOCKSET PARTS

PART NO.	DESCRIPTION	LIST PRICE
LEVERS – (Finish: 605,606,611,612,613,613E,613L,618,619,625,626,722)		
790F215	NZ - Plain	\$92.00
790F225	NZ - Cylinder or Button	\$92.00
790F235	NZ - Emergency Key Hole	\$92.00
790F245	NZ - Intruder	\$92.00
790F335	NZ - Sargent® Cylinder Cutout	\$92.00
790F345	NZ - Sargent Cylinder Cutout - Intruder	\$92.00
790F395	NZ - Corbin Russwin LFIC - 6 Pin	\$92.00
790F405	NZ - Corbin Russwin LFIC - 6 Pin Intruder	\$92.00
790F415	NZ - Corbin Russwin LFIC - 7 Pin	\$92.00
790F425	NZ - Corbin Russwin LFIC - 7 Pin Intruder	\$92.00
790F515	NZ - SFIC Cutout	\$92.00
790F525	NZ - SFIC Cutout Intruder	\$92.00
790F575	NZ - Schlage® LFIC Cutout	\$92.00
790F585	NZ - Schlage® LFIC Cutout - Intruder	\$92.00
774F225	PZ Yale® Cylinder Cutout 6/7 Pin	\$92.00
798F295	PZ Yale® Cylinder Cutout 6/7 Pin - Intruder	\$92.00
774F945	PZ Yale® Cylinder Cutout 6/7 Pin	\$92.00
798F305	PZ Yale® Cylinder Cutout 6/7 Pin - Intruder	\$92.00
780F215	NZ Security - Plain	\$92.00
780F225	NZ Security - Cylinder or Button	\$92.00
780F235	NZ Security - Emergency Key Hole	\$92.00
780F245	NZ Security - Intruder	\$92.00
780F335	NZ Security - Sargent Cylinder Cutout	\$92.00
780F345	NZ Security - Sargent Cylinder Cutout - Intruder	\$92.00
780F395	NZ Security - Corbin Russwin LFIC - 6 Pin	\$92.00
780F405	NZ Security - Corbin Russwin LFIC - 6 Pin Intruder	\$92.00
780F415	NZ Security - Corbin Russwin LFIC - 7 Pin	\$92.00
780F425	NZ Security - Corbin Russwin LFIC - 7 Pin Intruder	\$92.00
780F515	NZ Security - SFIC Cutout	\$92.00
780F525	NZ Security - SFIC Cutout Intruder	\$92.00
780F575	NZ Security - Schlage® LFIC Cutout	\$92.00
780F585	NZ Security - Schlage® LFIC Cutout - Intruder	\$92.00
790F225	PZ Yale® Cylinder Cutout 6/7 Pin	\$92.00
790F245	PZ Yale® Cylinder Cutout 6/7 Pin - Intruder	\$92.00
776F215	AZ - Plain	\$92.00
776F225	AZ - Cylinder or Button	\$92.00
776F235	AZ - Emergency Key Hole	\$92.00
776F245	AZ - Intruder	\$92.00
776F335	AZ - Sargent® Cylinder Cutout	\$92.00
776F345	AZ - Sargent Cylinder Cutout - Intruder	\$92.00
776F395	AZ - Corbin Russwin LFIC - 6 Pin	\$92.00
776F405	AZ - Corbin Russwin LFIC - 6 Pin Intruder	\$92.00
776F415	AZ - Corbin Russwin LFIC - 7 Pin	\$92.00
776F425	AZ - Corbin Russwin LFIC - 7 Pin Intruder	\$92.00
776F515	AZ - SFIC Cutout	\$92.00
776F525	AZ - SFIC Cutout Intruder	\$92.00
776F575	AZ - Schlage® LFIC Cutout	\$92.00
776F585	AZ - Schlage® LFIC Cutout - Intruder	\$92.00
777F215	AZ Security - Plain	\$92.00
777F225	AZ Security - Cylinder or Button	\$92.00
777F235	AZ Security - Emergency Key Hole	\$92.00
777F245	AZ Security - Intruder	\$92.00
777F335	AZ Security - Sargent Cylinder Cutout	\$92.00
777F345	AZ Security - Sargent Cylinder Cutout - Intruder	\$92.00
777F395	AZ Security - Corbin Russwin LFIC - 6 Pin	\$92.00
777F405	AZ Security - Corbin Russwin LFIC - 6 Pin Intruder	\$92.00
777F415	AZ Security - Corbin Russwin LFIC - 7 Pin	\$92.00
777F425	AZ Security - Corbin Russwin LFIC - 7 Pin Intruder	\$92.00
777F515	AZ Security - SFIC Cutout	\$92.00
777F525	AZ Security - SFIC Cutout Intruder	\$92.00
777F575	AZ Security - Schlage® LFIC Cutout	\$92.00
777F585	AZ Security - Schlage® LFIC Cutout - Intruder	\$92.00

PART NO.	DESCRIPTION	LIST PRICE
LEVERS – (Finish: 605,606,611,612,613,613E,613L,618,619,625,626,722)		
778F215	PZ - Plain	\$92.00
778F225	PZ - Cylinder or Button	\$92.00
778F235	PZ - Emergency Key Hole	\$92.00
778F245	PZ - Intruder	\$92.00
778F335	PZ - Sargent® Cylinder Cutout	\$92.00
778F345	PZ - Sargent Cylinder Cutout - Intruder	\$92.00
778F395	PZ - Corbin Russwin LFIC - 6 Pin	\$92.00
778F405	PZ - Corbin Russwin LFIC - 6 Pin Intruder	\$92.00
778F415	PZ - Corbin Russwin LFIC - 7 Pin	\$92.00
778F425	PZ - Corbin Russwin LFIC - 7 Pin Intruder	\$92.00
778F515	PZ - SFIC Cutout	\$92.00
778F525	PZ - SFIC Cutout Intruder	\$92.00
778F575	PZ - Schlage® LFIC Cutout	\$92.00
778F585	PZ - Schlage® LFIC Cutout - Intruder	\$92.00
778F225	PZ Yale® Cylinder Cutout 6/7 Pin	\$92.00
778F245	PZ Yale® Cylinder Cutout 6/7 Pin - Intruder	\$92.00
774F965	PZ Yale® Cylinder Cutout 6/7 Pin	\$92.00
798F395	PZ Yale® Cylinder Cutout 6/7 Pin - Intruder	\$92.00
774F985	PZ Yale® Cylinder Cutout 6/7 Pin	\$92.00
798F405	PZ Yale® Cylinder Cutout 6/7 Pin - Intruder	\$92.00
779F215	PZ Security - Plain	\$92.00
779F225	PZ Security - Cylinder or Button	\$92.00
779F235	PZ Security - Emergency Key Hole	\$92.00
779F245	PZ Security - Intruder	\$92.00
779F335	PZ Security - Sargent Cylinder Cutout	\$92.00
779F345	PZ Security - Sargent Cylinder Cutout - Intruder	\$92.00
779F395	PZ Security - Corbin Russwin LFIC - 6 Pin	\$92.00
779F405	PZ Security - Corbin Russwin LFIC - 6 Pin Intruder	\$92.00
779F415	PZ Security - Corbin Russwin LFIC - 7 Pin	\$92.00
779F425	PZ Security - Corbin Russwin LFIC - 7 Pin Intruder	\$92.00
779F515	PZ Security - SFIC Cutout	\$92.00
779F525	PZ Security - SFIC Cutout Intruder	\$92.00
779F575	PZ Security - Schlage® LFIC Cutout	\$92.00
779F585	PZ Security - Schlage® LFIC Cutout - Intruder	\$92.00

PART NO.	DESCRIPTION	LIST PRICE
ROSES		
D ROSE		
678F252 Fin	626/613E	\$52.00
	605,606,611,612,613,613L,618,619,625,722	
C ROSE		
779F97 Fin	626/613E	\$52.00
	605,606,611,612,613,613L,618,619,625,722	
ROSETTE FOR C & K ROSE		
778F90 Fin	626/613E	\$52.00
	605,606,611,612,613,613L,618,619,625,722	
E ROSE		
779F98 Fin	626/613E	\$52.00
	605,606,611,612,613,613L,618,619,625,722	
ROSETTE FOR E ROSE		
778F97 Fin	626/613E	\$52.00
	605,606,611,612,613,613L,618,619,625,722	
K ROSE		
779F99 Fin	626/613E	\$52.00
	605,606,611,612,613,613L,618,619,625,722	

LOCKSET PARTS

PART NO.	DESCRIPTION	LIST PRICE
LATCH ASSEMBLIES		
Standard		
780F81 Fin	10 Function	\$168.00
780F82 Fin	32, 40NT, 51, 52, 55, 57, 62, 72, and 80 Functions	
780F83 Fin	20 and 20H Functions	
780F84 Fin	29, 75, and 93 Functions	
780F85 Fin	61 Function	
3-3/4" Backset		
780F86 Fin	10 Function	\$168.00
780F87 Fin	32, 40NT, 51, 52, 55, 57, 62, 72, and 80 Functions	
780F88 Fin	20 and 20H Functions	
780F89 Fin	29, 75, and 93 Functions	
780F90 Fin	61 Function	
5" Backset		
780F91 Fin	10 Function	\$168.00
780F92 Fin	32, 40NT, 51, 52, 55, 57, 62, 72, and 80 Functions	
780F93 Fin	20 and 20H Functions	
780F94 Fin	29, 75, and 93 Functions	
780F95 Fin	61 Function	
3/4" Throw Fire Latch		
780F96 Fin	10, 51, 55, 57, 72, and 80 Functions	\$217.00

PART NO.	DESCRIPTION	LIST PRICE
STRIKES		
586L19	Curved Lip "T" Strike	\$27.00

PART NO.	DESCRIPTION	LIST PRICE
SLEEVE ASSEMBLIES		
STANDARD		
775F808	Outside Sleeve - 61 Function	\$180.00
776F002 Fin	Inside Sleeve - 51 Function	\$94.00
776F012 Fin	Inside Sleeve - 93 Function	\$94.00
776F022 Fin	Inside Sleeve - 61 Function	\$94.00
776F032 Fin	Inside Sleeve - 29 Function	\$180.00
776F042 Fin	Inside Sleeve - 20, 20H and 75 Functions	\$233.00
776F638	Outside Sleeve - 51,57,61,72, and 93 Functions	\$180.00
776F648	Outside Sleeve - 40NT Function	\$94.00
776F658	Outside Sleeve - 32 Function	\$168.00
776F668	Outside Sleeve - 55 and 62 Functions	\$168.00
776F678	Outside Sleeve - 29 Function	\$180.00
776F688	Outside Sleeve - 52 and 75 Functions	\$199.00
776F698	Outside Sleeve - 20 and 20H Functions	\$152.00
776F708	Inside Sleeve - 10, 55, and 80 Functions Outside Sleeve - 10 Function	\$83.00
776F848	Inside Sleeve - 52 and 72 Functions	\$233.00
776F858	Inside Sleeve - 32 Function	\$168.00
776F868	Inside Sleeve - 62 Function	\$168.00
776F878	Inside Sleeve - 40NT and 57 Functions	\$83.00

PART NO.	DESCRIPTION	LIST PRICE
SLEEVE ASSEMBLIES		
INTERCHANGEABLE CORE		
775F818	Outside Sleeve - 61 Function	\$180.00
776F718	Outside Sleeve - 51, 57, 72, 93 Functions	\$180.00
776F728	Outside Sleeve - 32 Function	\$168.00
776F738	Outside Sleeve - 55, 62 Functions	\$168.00
776F748	Outside Sleeve - 52, 75 Functions	\$199.00
776F918	Inside Sleeve - 61, 75 Functions	\$180.00
776F928	Inside Sleeve - 52, 72 Functions	\$168.00
776F938	Inside Sleeve - 32 Function	\$168.00
776F948	Inside Sleeve - 62 Function	\$164.00
3/4" THROW FIRE LATCH - STANDARD		
779F638	Outside Sleeve - 51, 57, 72 Functions	\$168.00
779F648	Outside Sleeve - 55 Function	\$168.00
779F658	Inside Sleeve - 72 Function Inside Sleeve - 57 Function	\$87.00
779F728	Inside Sleeve - 72 Function	\$233.00
779F738	Inside Sleeve - 57 Function	\$83.00
779F748	Inside Sleeve - 51 Function	\$168.00
3/4" THROW FIRE LATCH - INTERCHANGEABLE CORE		
779F758	Inside Sleeve - 72 Function	\$180.00
M111 SLEEVE ASSEMBLIES - STANDARD		
775F828	Outside Sleeve - 61 Function	\$180.00
776F758	Outside Sleeve - 51, 57, 72, 93 Functions	\$180.00
776F768	Outside Sleeve - 32 Function	\$168.00
776F778	Outside Sleeve - 55, 62 Functions	\$168.00
776F788	Outside Sleeve - 29 Function	\$180.00
776F798	Outside Sleeve - 52, 75 Functions	\$199.00
776F958	Inside Sleeve - 52, 72 Functions	\$233.00
776F968	Inside Sleeve - 32 Function	\$168.00
776F978	Inside Sleeve - 62 Function	\$168.00
M111 SLEEVE ASSEMBLIES - INTERCHANGEABLE CORE		
775F838	Outside Sleeve - 61 Function	\$180.00
776F808	Outside Sleeve - 51,57,61,72,93 Functions	\$180.00
776F818	Outside Sleeve - 32 Function	\$168.00
776F828	Outside Sleeve - 55, 62 Functions	\$168.00
776F838	Outside Sleeve - 52, 75 Functions	\$199.00
776F988	Inside Sleeve - 52, 72 Functions	\$168.00
776F998	Inside Sleeve - 32 Function	\$168.00
777F208	Inside Sleeve - 62 Function	\$168.00

PART NO.	DESCRIPTION	LIST PRICE
COLLARS		
778F888	Inside Collar	\$9.60
778F898	Outside Collar	\$9.60

PART NO.	DESCRIPTION	LIST PRICE
TAILPIECES		
778F788	Schlage® Fixed Core	\$20.00
780F658	SFIC Core	\$6.40
775F948	SARGENT Fixed Core	\$20.00
780F662	Schlage® LFIC	\$27.00
780F648	Corbin Russwin LFIC	\$3.20
774F878	Yale® LFIC 6-Pin	\$2.20
774F888	Yale® LFIC 7-Pin	\$2.20
780F808	Tail, Cylinder, 20H	\$3.20

LOCKSET PARTS

PART NO.	DESCRIPTION	LIST PRICE
MISCELLANEOUS		
778F638	Collar/Rosette Installation Wrench	\$9.60
780F638	Allen Key Wrench	\$9.60
780F208	M111 Screwdriver	\$6.40
604F228 Fin	Screw Packet	\$20.00
775F908 Fin	Mounting Kit Packet (CL3150)	\$26.00
775F918 Fin	Mounting Kit Packet (CL3170)	\$26.00
753F598	Rose Installation Tool	\$8.50
778F868	Aligning Pin	\$3.20
779F787	Bearing Assembly	\$227.00
778F812	Emergency Release Cylinder	\$52.00
206F578	Screw, combo #8 PH	\$3.20
790F988	Inside Mounting Flange Assembly	\$131.00
790F998	Outside Mounting Flange Assembly	\$131.00
403F302 Fin	Cup Washer	\$4.30
305F318 Fin	Machine Screw 1/4-20 x 2-3/4"	\$5.30
269F808	Countersunk Flat Head Screw 10-24x3/8" (1-3/4" Door)	\$3.20
778F968	Anchor Plate	\$3.20
778F91 Fin	Rosette Plug	\$45.00
790F988	Flange SA, Mounting I/S	\$131.00
790F998	Flange SA, Mounting O/S	\$131.00
220F718	Screw, FHM-PH, 10-24X1/2"	\$3.20
779F797	Bearing SA, D200	\$227.00
779F807	Bearing SA, M16	\$201.00
790F208	Screw, FHM-PH, #4-40X1/2"	\$5.30
679F818	Emergency Release Tool	\$3.20
778F759	Cylinder Spacer for 6-Pin Fixed Core Corbin Russwin or Yale® Cylinder	\$3.20

LOCKSET PARTS

PART NO.	DESCRIPTION	LIST PRICE	PART NO.	DESCRIPTION	LIST PRICE
CHASSIS ASSEMBLY STANDARD			LEVERS 1-3/4" TO 2" DOORS (Cont'd)		
785F008	for CL3310	\$180.00	596F825	NZD - SFIC (Best®) cylinder	\$120.00
785F118 Fin	for CL3320, CL3361	\$189.00	714F425	NZD - SFIC (Best®) cylinder CL3352 inside	
785F138 Fin	CL3320TO	\$180.00	690F975	NZD - Schlage® LFIC cylinder	
785F078 Fin	for CL3329	\$222.00	714F455	NZD - Schlage® LFIC cylinder CL3352 inside	\$120.00
785F068	for CL3332	\$214.00	563F885	AZD - Plain	
785F028 Fin	for CL3340	\$210.00	563F895	AZD - Cylinder or button	
785F038	for CL3340NT	\$191.00	714F005	AZD - CL3352 inside	\$120.00
785F018 Fin	CL3351, CL3357	\$191.00	563F905	AZD - Emergency key hole	
785F048	for CL3352, CL3355	\$222.00	585F705	AZD - LFIC cylinder - 6 pin	
785F148	for CL3359	\$191.00	714F305	AZD - LFIC cylinder - 6 pin CL3352 inside	\$120.00
785F058	for CL3362	\$214.00	600F425	AZD - LFIC cylinder - 7 pin	
785F088	for CL3372	\$203.00	714F315	AZD - LFIC cylinder - 7 pin CL3352 inside	
785F158 Fin	CL3375	\$203.00	695F075	AZD - Sargent® cylinder	\$120.00
785F088	for CL3380, CL3390	\$178.00	714F035	AZD - Sargent® cylinder CL3352 inside	
785F108	for CL3381, CL3391	\$203.00	578F435	NZD - Sargent cylinder	
785F378 Fin	CL3393	\$203.00	714F125	NZD - Sargent cylinder CL3352 inside	\$120.00
785F188	CL33903-12AD	\$493.00	799F505	PZD - plain	
785F168	CL33903-24AD	\$493.00	799F515	PZD - Cylinder or button	
785F198	CL33905-12AD	\$493.00	799F535	PZD - CL3352 inside	\$120.00
785F178	CL33905-24AD	\$493.00	799F525	PZD - Emergency key hole	
CHASSIS ASSEMBLY, LFIC			799F565	PZD - LFIC Cylinder - 6 pin	
785F298	for CL3361	\$214.00	799F575	PZD - LFIC Cylinder - 6 pin CL3352 inside	
785F268 Fin	for CL3329	\$235.00	799F585	PZD - LFIC Cylinder - 7 pin	
785F258	for CL3332	\$229.00	799F595	PZD - LFIC Cylinder - 7 pin CL3352 inside	\$120.00
785F218 Fin	for CL3351, CL3357, CL3393	\$210.00	799F805	PZD - SFIC (Best®) cylinder	
785F238	for CL3352	\$229.00	799F815	PZD - SFIC (Best®) cylinder CL3352 inside	
785F228	for CL3355	\$210.00	799F825	PZD - Schlage® LFIC cylinder	\$120.00
785F308	for CL3359	\$210.00	799F835	PZD - Schlage® LFIC cylinder CL3352 inside	
785F248	for CL3362	\$229.00	799F545	PZD - Sargent® cylinder	
785F278	for CL3372	\$194.00	799F555	PZD - Sargent® cylinder CL3352 inside	\$120.00
785F318 Fin	CL3375	\$218.00	712F205	FZD - LH plain	
785F288	for CL3381, CL3391	\$194.00	712F215	FZD - LH cylinder or button	
785F388 Fin	CL3393	\$493.00	712F385	FZD - LH CL3352 inside	\$120.00
785F348	CL33903-12AD	\$493.00	712F225	FZD - LH emergency key hole	
785F328	CL33903-24AD	\$493.00	715F245	FZD - LH LFIC cylinder - 6 pin	
785F358	CL33905-12AD	\$493.00	712F405	FZD - LH LFIC cylinder - 6 pin CL3352 inside	\$120.00
785F338	CL33905-24AD	\$493.00	714F255	FZD - LH LFIC cylinder - 7 pin	
CYLINDER PARTS			712F415	FZD - LH LFIC cylinder - 7 pin CL3352 inside	
622F308	Tailpiece 6-pin	\$3.20	712F265	FZD - LH SFIC (Best®) cylinder	
682F298	Tailpiece 7-pin	\$3.20	712F425	FZD - LH SFIC (Best®) cylinder CL3352 inside	
631F248	Corbin Russwin LFIC core kit	\$7.50	712F275	FZD - LH Schlage® LFIC cylinder	\$120.00
682F958	SFIC (Best®) tailpiece kit	\$7.50	712F435	FZD - LH Schlage® LFIC cylinder CL3352 inside	
682F969	Sargent® tailpiece kit	\$20.00	712F235	FZD - LH Sargent® cylinder	
697F942	Schlage® LFIC tailpiece kit	\$27.00	712F395	FZD - LH Sargent® cylinder CL3352 inside	\$120.00
682F398	Schlage® tailpiece kit	\$7.50	712F505	FZD - RH plain	
HOUSING ASSEMBLIES			712F515	FZD - RH cylinder or button	
783F208	Spring housing O/S	\$39.00	712F685	FZD - RH CL3352 inside	
783F308	Spring housing I/S 1 3/4" - 2"	\$33.00	712F525	FZD - RH emergency key hole	
783F408	Spring housing I/S 2 1/4"	\$33.00	712F545	FZD - RH LFIC cylinder - 6 pin	\$120.00
686F858	Dummy housing I/S	\$120.00	712F705	FZD - RH LFIC cylinder - 6 pin CL3352 inside	
686F868	Dummy housing O/S	\$110.00	712F555	FZD - RH LFIC cylinder - 7 pin	
LEVERS 1-3/4" TO 2" DOORS			712F715	FZD - RH LFIC cylinder - 7 pin CL3352 inside	\$120.00
563F945	NZD - Plain	\$120.00	712F565	FZD - RH SFIC (Best®) cylinder	
563F955	NZD - Cylinder button		712F725	FZD - RH SFIC (Best®) cylinder CL3352 inside	
714F065	NZD - CL3352 inside		712F575	FZD Schlage® LFIC cylinder	
563F965	NZD - Emergency key hole	\$120.00	712F735	FZD Schlage® LFIC cylinder CL3352 inside	
585F715	NZD - LFIC cylinder - 6 pin		712F535	FDZ - RH Sargent® cylinder	
714F365	NZD - LFIC cylinder - 6 pin CL3352 inside		712F695	FDZ - RH Sargent® cylinder CL3352 inside	
600F415	NZD - LFIC cylinder - 7 pin	\$120.00			
714F375	NZD - LFIC cylinder - 7 pin CL3352 inside				

LOCKSET PARTS

PART NO.	DESCRIPTION	LIST PRICE	PART NO.	DESCRIPTION	LIST PRICE
LEVERS 2 1/4" DOORS			LEVERS 2 1/4" DOORS (Cont'd)		
684F825	NZD - Plain	\$120.00	712F335	FZD - LH Sargent® cylinder	\$120.00
684F835	NZD - Cylinder or button		712F455	FZD - LH Sargent® cylinder CL3352 inside	
714F215	NZD - CL3352 inside		712F605	FZD - RH plain	\$120.00
684F845	NZD - Emergency key hole		712F615	FZD - RH cylinder or button	
684F865	NZD - LFIC cylinder - 6 pin	712F745	FZD - RH CL3352 inside		
714F545	NZD - LFIC cylinder - 6 pin CL3352 inside	712F625	FZD - RH emergency key hole	\$120.00	
685F875	NZD - LFIC cylinder - 7 pin	712F645	FZD - RH LFIC cylinder - 6 pin		
714F555	NZD - LFIC cylinder - 7 pin CL3352 inside	712F765	FZD - RH LFIC cylinder - 6 pin CL3352 inside		
684F885	NZD - SFIC (Best®) cylinder	712F655	FZD - RH LFIC cylinder - 7 pin		\$120.00
714F605	NZD - SFIC (Best®) cylinder CL3352 inside	712F775	FZD - RH LFIC cylinder - 7 pin CL3352 inside		
690F985	NZD - Schlage® LFIC cylinder	712F665	FZD - RH SFIC (Best®) cylinder		
714F635	NZD - Schlage® LFIC cylinder CL3352 inside	712F785	FZD - RH SFIC (Best®) cylinder CL3352 inside	\$120.00	
684F855	NZD - Sargent® cylinder	712F675	FZD - RH Schlage® LFIC cylinder		
714F275	NZD - Sargent® cylinder CL3352 inside	712F795	FZD - RH Schlage® LFIC cylinder CL3352 inside		
684F775	AZD - Plain	712F635	FZD - RH Sargent® cylinder		\$120.00
684F785	AZD - Cylinder or button	712F755	FZD - RH Sargent® cylinder CL3352 inside		
714F155	AZD - CL3352 inside	EMERGENCY RELEASE TOOL			
684F795	AZD - Emergency key hole	679F818	Emergency Release Tool (CL3320)	\$3.20	
684F805	AZD - LFIC cylinder - 6 pin	601F829	Emergency Release Label (CL3320)		
714F485	AZD - LFIC cylinder - 6 pin CL3352 inside	LEVER INSERT			
684F815	AZD - LFIC cylinder - 7 pin	585F729	Lever insert (black)	\$3.20	
714F495	AZD - LFIC cylinder - 7 pin CL3352 inside	LATCH ASSEMBLY			
697F995	AZD - Sargent® cylinder	2 3/4" Backsets			
714F185	AZD - Sargent® cylinder CL3352 inside	586F16	Plain, square corner	\$83.00	
799F605	PZD - Plain	596F66	Plain, round corner		
799F615	PZD - Cylinder or button	586F17	Deadlocking square corner	\$93.00	
799F635	PZD - CL3352 inside	596F67	Deadlocking round corner		
799F625	PZD - Emergency key hole	586F18	Throw-Off square corner		
799F665	PZD - LFIC cylinder - 6 pin	596F68	Throw-Off round corner		
799F675	PZD - LFIC cylinder - 6 pin CL3352 inside	601F69	3/4" Through deadlocking fire latch square corner	\$120.00	
799F685	PZD - LFIC cylinder - 7 pin	3 3/4" Backsets			
799F695	PZD - LFIC cylinder - 7 pin CL3352 inside	586F80	Plain, square corner	\$158.00	
799F845	PZD - SFIC (Best®) cylinder	586F86	Plain, round corner		
799F855	PZD - SFIC (Best®) cylinder CL3352 inside	586F81	Deadlocking square corner	\$166.00	
799F865	PZD - Schlage® LFIC cylinder	586F87	Deadlocking round corner		
799F875	PZD - Schlage LFIC cylinder CL3352 inside	586F82	Throw-Off square corner		
799F645	PZD - Sargent® cylinder	586F88	Throw-Off round corner		
799F655	PZD - Sargent® cylinder CL3352 inside	5" Backsets			
712F305	FZD - LH plain	598F20	Plain, square corner	\$113.00	
712F315	FZD - LH cylinder or botton	601F24	Plain, round corner		
712F445	FZD - LH CL3352 inside	598F21	Deadlocking square corner	\$121.00	
712F325	FZD - LH emergency key hole	601F25	Deadlocking round corner		
712F345	FZD - LH LFIC cylinder - 6 pin	598F22	Throw-Off square corner		
712F465	FZD - LH LFIC cylinder - 6 pin CL3352 inside	601F26	Throw-Off round corner		
712F355	FZD - LH LFIC cylinder - 7 pin				
712F475	FZD - LH LFIC cylinder - 7 pin CL3352 inside				
712F365	FZD - LH SFIC (Best®) cylinder				
712F485	FZD - LH SFIC (Best®) cylinder CL3352 inside				
712F375	FZD - LH Schlage® LFIC cylinder				
712F495	FZD - LH Schlage® LFIC cylinder CL3352 inside				

CL3300 Cylindrical Lock Series Extra Heavy-Duty Lever Lockset

USA & Canada Prices Effective March 16, 2020

LOCKSET PARTS

PART NO.	DESCRIPTION	LIST PRICE
LATCH & STRIKE SCREW PACKS		
604F228 Fin	Latch & ANSI (4 7/8") strike - phillips head	\$7.50
604F238 Fin	Latch & ANSI (4 7/8") strike - spanner head	\$16.00
604F248 Fin	Latch & ANSI (4 7/8") strike - Torx head	\$16.00
604F268 Fin	Latch & T (2 3/4") strike - phillips head	\$7.50
604F278 Fin	Latch & T (2 3/4") strike - spanner head	\$16.00
604F288 Fin	Latch & T (2 3/4") strike - Torx head	\$16.00
480F688 Fin	Rabbetted Strike - phillips head	\$7.50
596F618 Fin	Rabbetted Strike - spanner head	\$16.00
596F628 Fin	Rabbetted Strike - Torx head	\$16.00
MOUNTING SCREW PACKS		
682F608	1 3/4" - 2" doors (pre June 2004)	\$7.50
710F658	1 3/4" - 2" doors (after June 2004)	
682F618	Over 2" (pre June 2004)	\$11.00
710F668	Over 2" (after June 2004)	
682F628	CL3380, CL3381 1 3/4" - 2" doors	\$7.50
682F638	CL3380, CL3381 over 2" doors	\$11.00
682F64 Fin	CL3390, CL3391 1 3/4" - 2" phillips head	\$8.50
682F67 Fin	CL3390, CL3391 1 3/4" - 2" spanner head	\$16.00
682F68 Fin	CL3390, CL3391 1 3/4" - 2" Torx head	\$16.00
682F65 Fin	CL3390, CL3391 over 2" phillips head	\$51.00
682F86 Fin	CL3390, CL3391 over 2" spanner head	\$51.00
682F87 Fin	CL3390, CL3391 over 2" Torx head	\$51.00
684F44 Fin	CL3350 Half Dummy Trim - phillips head	\$11.00
684F45 Fin	CL3350 Half Dummy Trim - spanner head	\$51.00
684F46 Fin	CL3350 Half Dummy Trim - Torx head	\$51.00
684F528	CL3370 Half Dummy Trim	\$7.50
BUTTONS		
585F76 Fin	Turnbutton CL3351	\$23.00
585F77 Fin	Pushbutton CL3320, CL3320H, CL3320TO, CL3340, CL3361, CL3375	\$23.00
585F78 Fin	Hotel button CL3329	
585F79 Fin	Slotted button CL3393	

PART NO.	DESCRIPTION	LIST PRICE
FRONT PLATE RABBETTED STRIKE		
315F93 Fin*	606, 612, 619, 626, 605, 611, 613, 625	\$65.00
RABBETTED STRIKE		
315F94 Fin*	606, 612, 619, 626, 605, 611, 613, 625	\$65.00
601F283 Fin*	Rabbetted Strike & Front	\$101.00

ROSES		
678F25 Fin	Rose	\$31.00
598F59 Fin	Blank Rose	\$31.00
710F618	Rose liner I/S 1 3/4" - 2" after June 2004	\$7.50
710F628	Rose liner I/S over 2" after June 2004	\$7.50
678F248	Rose liner O/S 1 3/4" - 2"	
678F498	Rose liner O/S over 2"	\$7.50
586F51 Fin	Thumbturn ass'y 1 3/4" - 2"	\$100.00
686F88 Fin	Thumbturn ass'y over 2"	
682F788	Rose liner CL3380, CL3381	\$31.00

STRIKES - 4 7/8" ANSI CURVED LIP		
217L13M016	1" Lip Length	\$27.00
217L13M018	1 1/8" Lip Length	
217L13M020	1 1/4" Lip Length	
217L13M022	1 3/8" Lip Length	
217L13M024	1 1/2" Lip Length	
217L13M028	1 3/4" Lip Length	
217L13M032	2" Lip Length	\$27.00
217L13M036	2 1/4" Lip Length	
217L13M040	2 1/2" Lip Length	
217L13M044	2 3/4" Lip Length	
217L13M048	3" Lip Length	

STRIKES - 2 3/4" T- CURVED LIP		
586L19M016	1" Lip Length	\$27.00
586L19M018	1 1/8" Lip Length	
586L19M020	1 1/4" Lip Length	
586L19M022	1 3/8" Lip Length	
586L19M024	1 1/2" Lip Length	
586L19M028	1 3/4" Lip Length	
586L19M032	2" Lip Length	\$27.00
586L19M036	2 1/4" Lip Length	
586L19M040	2 1/2" Lip Length	
586L19M044	2 3/4" Lip Length	
586L19M048	3" Lip Length	

EMERGENCY RELEASE TOOL		
679F818	Emergency Release Tool (CL3320)	\$3.20
601F829	Emergency Release Label (CL3320)	

ASSA ABLOY

PART NO.	DESCRIPTION	LIST PRICE
BUTTONS		ALL FINISH
585F762	CL3551 (Turn Button)	\$23.00
585F772	CL3520, 61 (Push Button)	\$21.00
CASSETTE HOUSING O/S		NO FINISH
796F378	Standard	\$34.00
686F858	CL3550, 70	\$120.00
CASSETTE HOUSING I/S		NO FINISH
796F408	CL3580, 81	\$23.00
686F868	CL3570	\$110.00
796F398	Standard I/S Spring Housing	\$12.00
CHASSIS ASSEMBLY, STANDARD		NO FINISH
796F208	CL3510	\$94.00
796F218	CL3520, 61	\$133.00
796F248	CL3580	\$133.00
796F228	CL3551, 57	\$133.00
796F238	CL3555	\$133.00
796F258	CL3581	\$151.00
796F268	CL3582	\$179.00
CHASSIS ASSEMBLY, LFIC		NO FINISH
796F318	CL3561	\$133.00
796F328	CL3551, 57	\$133.00
796F338	CL3555	\$142.00
796F358	CL3581	\$158.00
796F368	CL3582	\$186.00
CYLINDER PARTS		NO FINISH
622F308	Tailpiece 6-Pin	\$3.20
682F298	Tailpiece 7-pin	\$3.20
682F398	M06 - Schlage® tailpiece kit	\$7.50
682F969	M09 - Sargent® tailpiece kit	\$20.00
631F248	C6/C7 - LFIC tailpiece kit	\$7.50
682F958	M08 - small format IC kit	\$7.50
697F942	M69 - Schlage® IC tailpiece kit	\$27.00
HOUSING ASSEMBLIES		
796F388	Housing Assembly, I/S, D134	\$23.00
796F398	Housing Assembly, I/S, D138	\$18.00

CL3500 Cylindrical Lock Series Heavy-Duty Lever Lockset

USA & Canada Prices Effective March 16, 2020

PART NO.	DESCRIPTION	LIST PRICE	
LATCHES		ALL FINISH	
Deadlocking Latches			
599F92	2-3/8" backset x 1" front	\$72.00	
599F95	2-3/8" backset x 1" round corner		
599F98	2-3/8" backset x 1-1/8" front		
600F01	2-3/8" backset x 1-1/8" round corner		
600F04	2-3/4" backset x 1" front		
600F07	2-3/4" backset x 1" round corner		
600F10	2-3/4" backset x 1-1/8" front		
600F13	2-3/4" backset x 1-1/8" round corner		
600F63	3-3/4" backset x 1-1/8" front		\$100.00
600F66	3-3/4" backset x 1-1/8" round corner		
600F69	5" backset x 1-1/8" front	\$100.00	
600F72	5" backset x 1-1/8" round corner		
Deadlocking Latches with Release (CL3520)			
599F93	2-3/8" backset x 1" front	\$72.00	
599F96	2-3/8" backset x 1" round corner		
599F99	2-3/8" backset x 1-1/8" front		
600F02	2-3/8" backset x 1-1/8" round corner		
600F05	2-3/4" backset x 1" front		
600F08	2-3/4" backset x 1" round corner		
600F11	2-3/4" backset x 1-1/8" front		
600F14	2-3/4" backset x 1-1/8" round corner		
600F64	3 3/4" backset x 1 1/8" front		\$100.00
600F67	3-3/4" backset x 1-1/8" round corner		
600F70	5" backset x 1 1/8" front	\$100.00	
600F73	5" backset x 1-1/8" round corner		
Plain Spring Latches (CL3610)			
599F91	2-3/8" backset x 1" front	\$72.00	
599F94	2-3/8" backset x 1" round corner		
599F97	2-3/8" backset x 1-1/8" front		
600F00	2-3/8" backset x 1-1/8" round corner		
600F03	2-3/4" backset x 1" front		
600F06	2-3/4" backset x 1" round corner		
600F09	2-3/4" backset x 1-1/8" front		
600F12	2-3/4" backset x 1-1/8" round corner		
600F62	3-3/4" backset x 1-1/8" front		\$100.00
600F65	3-3/4" backset x 1-1/8" round corner		
600F68	5" backset x 1-1/8" front	\$100.00	
600F71	5" backset x 1-1/8" round corner		

CL3500 Cylindrical Lock Series Heavy-Duty Lever Lockset

USA & Canada Prices Effective March 16, 2020

PART NO.	DESCRIPTION	LIST PRICE
LEVERS		ALL FINISH
598F815	AZD x plain	\$99.00
598F825	AZD x cylinder or button	\$99.00
598F835	AZD x emergency hole	\$99.00
598F905	AZD x C6 LFIC 6-pin	\$99.00
599F275	AZD x C7 LFIC 7-pin	\$99.00
797F845	NZD x plain	\$99.00
797F855	NZD x cylinder or button	\$99.00
797F865	NZD x emergency hole	\$99.00
797F875	NZD x M09 Sargent® cylinder	\$99.00
797F915	NZD x C6 LFIC 6-pin	\$99.00
797F925	NZD x C7 LFIC 7-pin	\$99.00
797F935	NZD x M69 Schlage LFIC	\$99.00
797F945	NZD x M08 SFIC	\$99.00
798F115	PZD x plain	\$99.00
798F125	PZD x cylinder or button	
798F135	PZD x emergency hole	
798F145	PZD x M09 Sargent® cylinder	\$99.00
798F155	PZD x C6 LFIC 6-pin	
798F165	PZD x C7 LFIC 7-pin	
798F175	PZD x M69 Schlage® LFIC	\$99.00
798F185	PZD x M08 SFIC	
LEVER INSERT		ALL FINISH
598F809	Standard	\$3.20
MOUNTING SCREW PACK		
796F118	Standard	\$5.30
797F828	Standard - CL3580, 81	\$14.00
684F448	CL3550 (ALL FINISH)	\$11.00
684F528	CL3570	\$7.50

PART NO.	DESCRIPTION	LIST PRICE
ROSES		ALL FINISH
678F252	Standard	\$33.00
598F592	Blank - CL3580, 81	\$33.00
ROSE LINER O/S		NO FINISH
678F248	Standard	\$6.40
682F788	CL3580, 81	\$31.00
SCREW PACKS FOR LATCH & STRIKE		
604F228	For Latch & ANSI Strike	\$7.50
604F268	For Latch & (T strike)	\$7.50
STRIKES		NO FINISH
ANSI Curved Lip Strike		
217L13M016	1" Lip Length	\$27.00
217L13M018	1-1/8" Lip Length	
217L13M020	1-1/4" Lip Length	
217L13M022	1-3/8" Lip Length	
217L13M024	1-1/2" Lip Length	
217L13M028	1-3/4" Lip Length	\$27.00
217L13M032	2" Lip Length	
217L13M036	2-1/4" Lip Length	
217L13M040	2-1/2" Lip Length	
217L13M044	2-3/4" Lip Length	
217L13M048	3" Lip Length	
STRIKE BOX		NO FINISH
025F858	Curved lip (T strike)	\$4.30

CL3700 Cylindrical Lock Series Grade 2 Key-In-Lever Locksets

CL3700 SERIES		
PART NO.	DESCRIPTION	LIST PRICE
MISCELLANEOUS		
679F818	Emergency Release Tool	\$3.20

CL3800 PARTS

PART NO.	DESCRIPTION	LIST PRICE
BUTTONS		ALL FINISH
585F762	CL3851 (Turn Button)	\$23.00
585F772	CL3820, 40, 61 (Push Button)	\$21.00
CASSETTE HOUSING O/S		NO FINISH
796F378	Standard	\$34.00
686F858	CL3850, 70	\$120.00
CASSETTE HOUSING I/S		NO FINISH
796F398	Standard - 1-3/8" to 1-7/8" door	\$18.00
797F808	D214 - 2" to 2-1/4" door	\$23.00
796F408	CL3880, 81	\$23.00
686F868	CL3870	\$110.00
CHASSIS ASSEMBLY, STANDARD		NO FINISH
797F618	CL3810	\$58.00
797F628	CL3820, 61	\$65.00
797F658	CL3880	\$58.00
797F668	CL3851, 57	\$69.00
797F688	CL3855	\$69.00
CHASSIS ASSEMBLY, IC		NO FINISH
797F638	CL3861	\$67.00
797F678	CL3851, 57	\$71.00
797F698	CL3855	\$71.00

PART NO.	DESCRIPTION	LIST PRICE	
CYLINDER PARTS		NO FINISH	
622F308	Tailpiece 6-Pin	\$3.20	
682F298	Tailpiece 7-pin	\$3.20	
682F398	M06 - Schlage® tailpiece kit	\$20.00	
682F969	M09 - SARGENT® tailpiece kit	\$20.00	
631F248	C6/C7 - LFIC tailpiece kit	\$7.50	
682F958	M08 - SFIC kit	\$7.50	
697F942	M69 - Schlage® LFIC tailpiece kit	\$27.00	
LATCHES		ALL FINISH	
Deadlocking Latches			
599F92	2-3/8" backset x 1" front	\$72.00	
599F95	2-3/8" backset x 1" round corner		
599F98	2-3/8" backset x 1-1/8" front		
600F01	2-3/8" backset x 1-1/8" round corner		
600F04	2-3/4" backset x 1" front		
600F07	2-3/4" backset x 1" round corner		
600F10	2-3/4" backset x 1-1/8" front		
600F13	2-3/4" backset x 1-1/8" round corner		
600F63	3-3/4" backset x 1-1/8" front		\$100.00
600F66	3-3/4" backset x 1-1/8" round corner		\$100.00
600F69	5" backset x 1-1/8" front	\$100.00	
600F72	5" backset x 1-1/8" round corner	\$100.00	
Deadlocking Latches with Release (CL3820)			
599F93	2-3/8" backset x 1" front	\$72.00	
599F96	2-3/8" backset x 1" round corner		
599F99	2-3/8" backset x 1-1/8" front		
600F02	2-3/8" backset x 1-1/8" round corner		
600F05	2-3/4" backset x 1" front		
600F08	2-3/4" backset x 1" round corner		
600F11	2-3/4" backset x 1-1/8" front		
600F14	2-3/4" backset x 1-1/8" round corner		
600F64	3 3/4" backset x 1 1/8" front		\$100.00
600F67	3-3/4" backset x 1-1/8" round corner		\$100.00
600F70	5" backset x 1 1/8" front	\$100.00	
600F73	5" backset x 1-1/8" round corner	\$100.00	
Plain Spring Latches (CL3610)			
599F91	2-3/8" backset x 1" front	\$72.00	
599F94	2-3/8" backset x 1" round corner		
599F97	2-3/8" backset x 1-1/8" front		
600F00	2-3/8" backset x 1-1/8" round corner		
600F03	2-3/4" backset x 1" front		
600F06	2-3/4" backset x 1" round corner		
600F09	2-3/4" backset x 1-1/8" front		
600F12	2-3/4" backset x 1-1/8" round corner		
600F62	3-3/4" backset x 1-1/8" front		\$100.00
600F65	3-3/4" backset x 1-1/8" round corner		\$89.00
600F68	5" backset x 1-1/8" front	\$100.00	
600F71	5" backset x 1-1/8" round corner	\$92.00	

CL3800 Cylindrical Lock Series Grade 2 Key-In-Lever Lockset

USA & Canada Prices Effective March 16, 2020

CL3800 PARTS

PART NO.	DESCRIPTION	LIST PRICE
LEVERS 1-3/8" to 1-7/8" Doors		ALL FINISH
598F815	AZD x plain	\$99.00
598F825	AZD x cylinder or button	\$99.00
598F835	AZD x emergency hole	\$99.00
598F905	AZD x C6 LFIC 6-pin	\$99.00
599F275	AZD x C7 LFIC 7-pin	\$99.00
797F845	NZD x plain	\$99.00
797F855	NZD x cylinder or button	\$99.00
797F865	NZD x emergency hole	\$99.00
797F875	NZD x M09 Sargent® cylinder	\$99.00
797F915	NZD x C6 LFIC 6-pin	\$99.00
797F925	NZD x C7 LFIC 7-pin	\$99.00
797F935	NZD x M69 Schlage LFIC	\$99.00
797F945	NZD x M08 SFIC	\$99.00
798F115	PZD x plain	\$99.00
798F125	PZD x cylinder or button	\$99.00
798F135	PZD x emergency hole	\$99.00
798F145	PZD x M09 Sargent® cylinder	\$99.00
798F155	PZD x C6 LFIC 6-pin	\$99.00
798F165	PZD x C7 LFIC 7-pin	\$99.00
798F175	PZD x M69 Schlage® LFIC	\$99.00
798F185	PZD x M08 SFIC	\$99.00
LEVERS 2" to 2-1/4" Doors - D214		ALL FINISH
684F775	AZD x plain	\$120.00
684F785	AZD x cylinder or button	\$118.00
684F795	AZD x emergency hole	\$118.00
684F805	AZD x C6 LFIC 6-pin	\$120.00
684F815	AZD x C7 LFIC 7-pin	\$118.00
684F825	NZD x plain	\$120.00
684F835	NZD x cylinder or button	\$118.00
684F845	NZD x emergency hole	\$118.00
684F855	NZD x M09 Sargent® cylinder	\$118.00
684F865	NZD x C6 LFIC 6-pin	\$120.00
684F875	NZD x C7 LFIC 7-pin	\$118.00
690F985	NZD x M69 Schlage® LFIC	\$118.00
684F885	NZD x M08 SFIC	\$120.00
798F215	PZD x plain	\$118.00
798F225	PZD x cylinder or button	\$118.00
798F235	PZD x emergency hole	\$118.00
798F245	PZD x M09 Sargent® cylinder	\$118.00
798F255	PZD x C6 LFIC 6-pin	\$118.00
798F265	PZD x C7 LFIC 7-pin	\$118.00
798F275	PZD x M69 Schlage® LFIC	\$118.00
798F285	PZD x M08 SFIC	\$118.00

PART NO.	DESCRIPTION	LIST PRICE
LEVER INSERT		ALL FINISH
598F809	Standard - 1-3/8" to 1-7/8" door	\$3.20
684F539	D214 - 2" to 2-1/4" door	\$47.00
MOUNTING SCREW PACK		
796F118	Standard - 1-3/8" to 1-7/8" door	\$5.30
797F818	D214 - 2" to 2-1/4" door	\$18.00
797F828	Standard - CL3880, 81, 90, 91	\$14.00
797F838	D214 - CL3880, 81, 90, 91	\$18.00
684F448	CL3850 (ALL FINISH)	\$11.00
684F528	CL3870	\$7.50
ROSES		ALL FINISH
678F252	Standard	\$33.00
598F592	Blank - CL3880, 81	\$33.00
ROSE LINER O/S		NO FINISH
678F248	Standard - 1-3/8" to 1-7/8" door	\$6.40
678F498	D214 - 2" to 2-1/4" door	\$7.50
682F788	CL3880, 81	\$31.00
SCREW PACK FOR LATCH & STRIKE		ALL FINISH
604F228	For Latch & ANSI Strike	\$7.50
604F268	For Latch & 'T' or Full Lip Strike	\$7.50
STRIKES*		ALL FINISH
680L52	ANSI Curved Lip Blank Strike	\$27.00
586L19	T-Strike	
680L50	Full Lip Strike	
680L51	Full Lip Strike 1/4" Radius (Available Only 1-1/4" Lip)	\$17.00
STRIKE BOX		NO FINISH
025F858	Curved lip (T strike)	\$4.30
THUMBTURNS		ALL FINISH
586F512	Standard - 91	\$100.00
686F882	D214 - 91	\$100.00

*Specify length and finish

LOCKSET PARTS

PART NO.	DESCRIPTION	LIST PRICE
SCREW PACKET 605, 613E, 630		
556F558	for CK4350 †Order 50-	\$3.20
604F268	for curved lip strike	\$6.40
604F298	for curved lip strike x hex head (M04)	\$13.00
604F278	for curved lip strike x spanner head (M02)	\$17.00
604F288	for curved lip strike x Torx® head (M04)	\$16.00
604F258	for hex head (M04)	\$5.30
604F238	for spanner head (M02)	\$16.00
480F68	for SR118	\$6.40
596F638	for SR118 & hex head (M04)	\$7.50
596F618	for SR118 & spanner head (M02)	\$8.50
596F628	for SR118 & Torx head (M04)	
604F228	standard	\$6.40
604F248	for Torx head (M04)	\$16.00
224F008*	Screw, Sems Assembly #8 -32 X 1-1/4" †Order 100-	\$3.20

STRIKE 605, 613E, 630		
---------------------------------	--	--

ANSI Curved Lip Strike		
217L13M016	1" Lip Length	\$27.00
217L13M018	1-1/8" Lip Length	
217L13M020	1-1/4" Lip Length	
217L13M022	1-3/8" Lip Length	
217L13M024	1-1/2" Lip Length	
217L13M028	1-3/4" Lip Length	\$27.00
217L13M032	2" Lip Length	
217L13M036	2-1/4" Lip Length	
217L13M040	2-1/2" Lip Length	
217L13M044	2-3/4" Lip Length	
217L13M048	3" Lip Length	

PART NO.	DESCRIPTION	LIST PRICE
STRIKE (Cont'd)		
Curved Lip Box Strike		
586L19M016	1" Lip Length	\$27.00
586L19M018	1-1/8" Lip Length	
586L19M020	1-1/4" Lip Length	
586L19M022	1-3/8" Lip Length	
586L19M024	1-1/2" Lip Length	
586L19M028	1-3/4" Lip Length	\$27.00
586L19M032	2" Lip Length	
586L19M036	2-1/4" Lip Length	
586L19M040	2-1/2" Lip Length	
586L19M044	2-3/4" Lip Length	
586L19M048	3" Lip Length	

†Sold only in multiples of the number indicated. Price is each.

CK4400 SERIES

PART NO.	DESCRIPTION	LIST PRICE
STRIKES AND WROUGHT BOX		
ANSI TYPE 605, 606, 611, 612, 613, 619, 625, 626		
217L13M016	1" Lip to Center	\$27.00
217L13M018	1-1/8" Lip to Center	
217L13M020	1-1/4" Lip to Center (standard)	
217L13M022	1-3/8" Lip to Center	
217L13M024	1-1/2" Lip to Center	
217L13M028	1-3/4" Lip to Center	\$27.00
217L13M032	2" Lip to Center	
217L13M036	2-1/4" Lip to Center	
217L13M040	2-1/2" Lip to center	
217L13M044	2-3/4" Lip to Center	
217L13M048	3" Lip to Center	
CURVED LIP BOX TYPE STRIKE 605, 606, 611, 612, 613, 619, 625, 626		
586L19M016	1" Lip Length	\$27.00
586L19M018	1-1/8" Lip Length	
586L19M020	1-1/4" Lip Length	
586L19M022	1-3/8" Lip Length	
586L19M024	1-1/2" Lip Length	
586L19M028	1-3/4" Lip Length	\$27.00
586L19M032	2" Lip Length	
586L19M036	2-1/4" Lip Length	
586L19M040	2-1/2" Lip Length	
586L19M044	2-3/4" Lip Length	
586L19M048	3" Lip Length	

PART NO.	DESCRIPTION	LIST PRICE
ROSE		
NO FINISH		
579F11	Screw Packet & Strike Box	\$6.40
580F387	Rose Sub Assembly, stainless I/S	\$18.00
580F38	Rose Sub Assembly I/S	\$17.00
LATCHES		
574F29	2-3/8" deadlatch	\$43.00
574F30	2-3/8" deadlatch with throw-off	
574F55	2-3/4" deadlatch	
574F56	2-3/4" deadlatch with throw-off	
574F29 x574F25	3-3/4" deadlatch	\$75.00
574F30 x574F25	3-3/4" deadlatch with throw-off	
574F29 x574F26	5" deadlatch	
574F30 x574F26	5" deadlatch with throw-off	
BACKSET EXTENDER KIT		
574F258	Extender ONLY (No Latch Unit) - Must be added to 2-3/8" Latch Unit	\$34.00
574F268	Extender ONLY (No Latch Unit) - Must be added to 2-3/8" Latch Unit	

LOCKSET PARTS

PART NO.	DESCRIPTION	LIST PRICE	PART NO.	DESCRIPTION	LIST PRICE	
BUSHING			HUB SPACER			
		NO FINISH			NO FINISH	
194F228	Bushing	\$4.30	060F338	for UT5210, 61	†Order 50- \$3.20	
BUTTON ASSEMBLY			NO FINISH			
	612, 613, 619, 625, 626		070F428	for UT5220	†Order 50- \$3.20	
022F80	for UT5220	\$61.00	070F438	for UT5220	†Order 50- \$5.30	
157F11	for UT5251		606F038	for UT5255	\$3.20	
156F43	for UT5261		067F428	for UT5257	\$4.30	
CHASSIS COVER			LEVER			
		NO FINISH			612, 613, 619, 625, 626	
138F888	Chassis Cover	\$7.50	582F122	cyl/button LH	\$219.00	
CHASSIS			582F112	cyl/button RH		
	612, 613, 619, 625, 626		582F142	cyl/button LH tactile	\$219.00	
496F33	for UT5210	\$345.00	582F132	cyl/button RH tactile		
496F34	for UT5220		489F892	LFIC 6-pin LH	\$219.00	
496F32	for UT5251, 55, 57, 72		489F882	LFIC 6-pin RH		
198F71	for UT5261		549F362	LFIC 6-pin LH tactile	\$227.00	
381F30	for UT5282		549F352	LFIC 6-pin RH tactile		
CORE HOUSING			NO FINISH			
		NO FINISH	613F232	LFIC 7-pin LH	\$219.00	
342F052	for 6-pin LFIC	\$13.00	613F222	LFIC 7-pin RH		
442F952	for 7-pin LFIC		613F252	LFIC 7-pin LH tactile	\$227.00	
613F352	for 6/7 pin Best-type LFIC	\$11.00	613F242	LFIC 7-pin RH tactile		
COUPLING			NO FINISH			
		NO FINISH	613F112	plain LH	\$219.00	
131F278	Coupling	\$60.00	613F102	plain RH		
EMERGENCY KEY			NO FINISH			
		NO FINISH	613F152	plain LH tactile	\$219.00	
679F818	for UT5220	\$3.20	613F142	plain RH tactile		
ESCUTCHEON			NO FINISH			
		NO FINISH	613F132	priv. key hole LH	\$219.00	
144F33	for inside lever	\$170.00	613F122	priv. key hole RH		
415F16	for outside knob		613F172	priv. key hole LH tactile	\$219.00	
144F34	for outside lever		613F162	priv. key hole RH tactile		
605F90	for inside lever, lead lined		613F432	Best - type core prep LH	\$241.00	
301F567	for outside lever, ext. lip 630 only		613F422	Best - type core prep RH		
GRIP RETAINER			LEVER INSERT			
		NO FINISH			NO FINISH	
078F078	Grip Retainer	†Order 50-	\$3.20	613F029	Lever Insert	†Order 50- \$3.20
HUB			NO FINISH			
		NO FINISH			NO FINISH	
060F428	for all but UT5255	\$4.30	LEVER SPRING ANCHOR			
071F628	for UT5210	\$5.30			NO FINISH	
081F778	for UT5220	\$6.40	171F798	Lever Spring Anchor	\$18.00	
147F078	for UT5251, 55, 72	\$4.30	PIN			
140F978	for UT5251, 57, 72	\$4.30			NO FINISH	
071F638	for UT5257	\$4.30	019F137	Pin, Spindle Drive	†Order 50- \$3.20	
			156F837	Pin, UT5261 shank	†Order 50- \$3.20	
			286F507	Pin, UT5282 spindle	†Order 50- \$3.20	

†Sold only in multiples of the number indicated. Price is each.

UT5200 Series Pre-Assembled Unit Locksets

USA & Canada Prices Effective March 16, 2020

PART NO.	DESCRIPTION	LIST PRICE
PLUG DRIVER NO FINISH		
144F888	Plug Driver & Spindle Assembly UT5282	\$44.00
168F818	Plug Driver Assembly	\$28.00
144F298	Plug Driver UT5251, 57, 72	\$17.00
606F018	Plug Driver UT5255	\$16.00
145F328	Plug Driver UT5282	\$44.00
RETAINING RING NO FINISH		
251F198	Retaining Ring for UT5282 Spindle †Order 100-	\$3.20
SCREW 612, 619, 626, 613, 625		
480F70	Screw Pkt. (strike mount'g) †Order 20-	\$3.20
No Finish		
249F768	Screw, Fixed Escutcheon †Order 50-	\$3.20
092F789	Screw, Strike Adjustment (nylon) †Order 50-	\$3.20
SHANK, LEVER NO FINISH		
102F198	for UT5210, 57 outside	\$52.00
102F378	for UT5220 inside	
114F678	for UT5220 outside	
188F758	for UT5251, 57, 72 outside	
188F738	for UT5251, 72 inside	\$60.00
605F768	for UT5255 inside	\$54.00
605F778	for UT5255 outside	\$54.00
156F658	for UT5261 inside	\$95.00
156F648	for UT5261 outside	\$64.00
102F278	for UT5282 inside	\$54.00
287F608	for UT5282 outside	\$80.00
SHANK RETAINER NO FINISH		
242F508	for lever †Order 50-	\$3.20

† Sold only in multiples of the number indicated. Price is each.

PART NO.	DESCRIPTION	LIST PRICE
SPINDLE NO FINISH		
201F188	for UT5220	\$8.50
144F308	for UT5251, 72	\$8.50
606F028	for UT5255	\$8.50
335F988	for UT5257	\$12.00
SPRING NO FINISH		
022F723	Spring, Button UT5220, 61 †Order 50-	\$3.20
103F458	Spring, Lever Return LH	\$11.00
103F448	Spring, Lever Return RH	\$11.00
060F053	Spring, Shoe UT5220, 61 †Order 100-	\$3.20
071F673	Spring, Spindle for UT5220 †Order 100-	\$3.20
249F773	Spring, Spindle for UT5251, 55, 57, 72 †Order 100-	\$3.20
261F118	Spring, Spindle for UT5282 †Order 100-	\$3.20
STRIKE 612, 613, 625, 626		
236L75M020	ANSI curved lip	\$26.00
610L44	ANSI straight lip	
610L43	ANSI straight lip for ext. esc.	
083L96M032	curved lip box, 2"	
083L96M036	curved lip box, 2-1/4"	
083L96M034	curved lip box, 2-1/8" (std)	
083L96M040	curved lip box, 2-1/2"	
083L96M048	curved lip box, 3"	
293L14	curved lip box for ext. lip esc.	
082L67	pairs of doors	
THROUGHBOLT		
222F85	Regular	\$6.40
223F29	Spanner head	\$6.40
THROW MEMBER NO FINISH		
320F442	for Best® style core	\$7.50
342F032	for Corbin Russwin core	\$7.50

Padlocks and Deadlocks

PADLOCKS			
PART NO.	DESCRIPTION	LIST PRICE	SOLD IN MULT. OF
422L842144	Chain & clevis, 9" brass	\$23.00	1
422L848144	Chain & clevis, 9" steel	\$21.00	1
303F242	Pin chamber cap	\$3.20	100
228F348	Plug retainer, oversize Spirol pin	\$3.20	100
244F647	Plug retainer, standard solid pin	\$3.20	20
405F772	Security disc	\$3.20	50
756F963	Throw member, LFIC models	\$9.60	10

DL4100 SERIES DEADLOCK PARTS			
PART NO.	DESCRIPTION	LIST PRICE	SOLD IN MULT. OF
796F46 x Fin	Outside Front	\$95.00	
796F30 x Fin	Thumbturn Assembly	\$79.00	
791F51 x Fin	Ergonomic Thumbturn Assembly	\$72.00	
Mouting Packs:			
791F82 Fin	Screw Pack - Standard Strike	\$23.00	
791F83 Fin	Spanner Head crew Pack - Standard Strike	\$16.00	
791F84 Fin	Torx Head Screw Pack - Standard Strike	\$16.00	
791F85 Fin	Screw Pack - ANSI Strike	\$5.30	
791F86 Fin	Spanner Head crew Pack - ANSI Strike	\$16.00	
791F87 Fin	Torx Head Screw Pack - ANSI Strike	\$16.00	
Strikes:			
796F43	Standard Strike	\$15.00	
240L08018	ANSI Strike 1-3/4" Door	\$23.00	
240L08020	ANSI Strike 2" Door	\$23.00	
240L08022	ANSI Strike 2-1/4" Door	\$23.00	
466F279	Strike Box	\$11.00	

DL3000 SERIES DEADLOCKS			
PART NO.	DESCRIPTION	LIST PRICE	SOLD IN MULT. OF
261F298	Allen wrench 5/64"	\$4.30	10
467F36	Bolt front	\$18.00	1
467F345	Cylinder housing	\$55.00	1
467F338	Cylinder housing screw	\$3.20	20
480F708	Screw pack for ANSI strike	\$3.20	20
480F69	Screw pack for strikes 424F83 and 394F19	\$4.30	20
283F81	Collar Base / Rose	\$51.00	1
Strike, 2-3/4" x 1-1/8			
424F838	605, 606, 611, 612, 613, 618, 619, 625, 626	\$33.00	1
		\$19.00	1
		\$23.00	1
394F198	Strike, 3-1/2" x 1-1/8"	\$22.00	1
Strike, ANSI			
423L71	611,613, and all other finishes	\$31.00	1
416F38	Security collar	\$46.00	1
467F358	Bolt, less front -2-3/4" B.S.	\$47.00	1
693F208	Bolt, less front -2-3/8" B.S.	\$47.00	1
467F378	Strike box	\$7.50	1
496F718	Strike box	\$6.40	1

DEVICE PARTS					
PART NO.	DESCRIPTION	LIST PRICE	PART NO.	DESCRIPTION	LIST PRICE
ACTIVE HEAD (FIELD REVERSIBLE, WHERE HANDED)			NO FINISH		
650F378	ED4200	\$268.00	DELAYED EGRESS PC BOARDS		
681F618	ED4200S	\$286.00			
650F418	ED4400 LHR	\$282.00			
650F408	ED4400 RHR				
650F468	ED4800 LHR	\$294.00			
650F458	ED4800 RHR				
650F358	ED5200	\$268.00			
650F368	ED5200A	\$282.00			
706F038	ED5202 RHR	\$315.00			
706F048	ED5202 LHR				
706F058	ED5202A RHR	\$328.00			
706F068	ED5202A LHR				
681F608	ED5200S(A)	\$286.00			
706F078	ED5202S(A) RHR	\$332.00			
706F088	ED5202S(A) LHR				
650F398	ED5400(A) LHR	\$282.00			
650F388	ED5400(A) RHR				
650F428	ED5600(A)	\$268.00			
706F098	ED5602(A) RHR	\$315.00			
706F108	ED5602(A) LHR				
650F448	ED5800(A) LHR	\$294.00			
650F438	ED5800(A) RHR				
ARMORED FRONT 605, 606, 611, 612, 613, 619, 625, 626, 629, 630			COVER, BAR 605, 606, 611, 612, 613, 619, 625, 626, 629, 630		
650F06	ED5600	\$19.00	650F07	36"	\$60.00
BAR & CARRIER ASSEMBLY			NO FINISH		
650F248	All 48"	\$311.00	650F08	48"	\$60.00
650F238	ED4000 36"	\$295.00	COVER, END		
650F228	ED5000 36"				
BAR CAP			NO FINISH		
650F189	Black nylon	†Order 10-	\$5.30	ED5000DB	
BOTTOM BOLT CASE			NO FINISH		
650F588	ED4400, ED5400	\$48.00	605, 606, 611, 612, 613, 619, 625, 626, 629, 630		
650F598	ED5400A	\$52.00	ED4000 36" cyl. dogging		
BOTTOM BOLT PACKET					
650F778	ED4800	\$144.00	605, 606, 611, 612, 613, 619, 625, 626, 629, 630		
698F038	ED5800(A)	\$127.00	ED4000 36" standard		
BOTTOM RAIL					
650F21	48"	\$186.00	605, 606, 611, 612, 613, 619, 625, 626, 629, 630		
	606, 612, 630				
	605, 613				
	611, 625, 626, 629				
BOTTOM ROD & COUPLER ASSEMBLY			NO FINISH		
650F798	ED4800, ED5800(A)	\$108.00	ED5000 36" cyl. dogging		
BOTTOM ROD & END PIN ASSEMBLY 605, 606, 611, 612, 613, 618, 619, 625, 626, 629, 630, 722					
649F99 fin	Surface devices	\$173.00	605, 606, 611, 612, 613, 619, 625, 626, 629, 630		
CARRIER BAR NO FINISH			NO FINISH		
650F998	Internal	\$17.00	ED5000(A) 36" standard		
COVER, ACTIVE HEAD 605, 606, 611, 612, 613, 619, 625, 626, 629, 630					
650F00	ED5200	\$217.00	605, 606, 611, 612, 613, 619, 625, 626, 629, 630		
650F03	ED4200				
681F63	ED4200S				
650F04	ED4400				
650F05	ED4800				
681F62	ED5200S				
706F15	ED5602 RHR		\$230.00	COVER, TOP & BOTTOM LATCH	
706F16	ED5602 LHR				
DOGGING ASSEMBLY			NO FINISH		
650F968	Cylinder type	\$43.00	ED4400, ED5400(A)		
650F528	Hex Key type				
DOGGING CYLINDER NUT			NO FINISH		
697F862	Dogging Cylinder Nut	\$17.00	605, 606, 611, 612, 613, 619, 625, 626, 629, 630		

†Sold only in multiples of the number indicated. Price is each.

ED4000/ED5000 Series Pushpad Exit Devices

USA & Canada Prices Effective March 16, 2020

DEVICE PARTS (Cont'd)

PART NO.	DESCRIPTION	LIST PRICE
DOGGING CYLINDER SLEEVE		
650F959	Dogging Cylinder Sleeve	\$9.60
DOGGING HOLE PLUG		
650F279	Dogging Hole Plug †Order 50-	\$2.20
DOGGING KEY, HEX		
656F408	5/32"	\$4.30
END CAP RETROFIT KIT		
704F66	End Cap Retrofit Kit	\$91.00
END CAP		
704F62	End Cap	\$67.00
710F00M	Flush End Cap Retrofit Kit (M110)	\$85.00
END CLAMP PACKET		
592F338	ED4000, ED5000-D214	\$15.00
704F658	ED4200(S), ED5200S(A)	
704F648	ED4000, ED5000(A)	
FLUSH STRIKE TRANSOM BRACKET		
650F878	Flush strike transom brkt., ED5400(A)	\$60.00
LATCH PACKET		
654F218	Latch pkt, ED4400, ED5400 †Order 10-	\$5.30
MORTISE LOCK BODY		
655F488RR	ED5610 knob - RHR	\$367.00
655F488LR	ED5610 knob - LHR	
650F698RR	ED5602, ED5610, ED5655 lever - RHR	\$367.00
650F698LR	ED5602, ED5610, ED5655 lever - LHR	
678F008RR	ED5610, ED5655 thumbpiece - RHR	\$367.00
678F008LR	ED5610, ED5655 thumbpiece - LHR	
650F678RR	ED5650,57 knob, lever/thumbpiece - RHR	\$367.00
650F678LR	ED5650,57 knob, lever/thumbpiece - LHR	
710F318LR	ED5634L - LHR	\$629.00
710F318RR	ED5634L - RHR	
710F328LR	ED5634L - LHR - M91	\$629.00
710F328RR	ED5634L - RHR - M91	
710F338LR	ED5634L - LHR - M93	\$612.00
710F338RR	ED5634L - RHR - M93	
ADAPTER ASSEMBLY, MORTISE		
706F462	ED5602(A)	\$34.00
MOUNTING PACKET		
650F578	ED4400, ED5400(A)	\$97.00
654F208	Non-rated, wood door †Order 20-	\$4.30
900, WS700 & FE700 SERIES MULLION PACKETS		
TOP RETAINER AND SCREW PACKET		
713F518	907, 908, 910, 907A, 908A	\$228.00
713F938	FE707A, FE708A	\$236.00
713F948	907BKM, 908BKM, 910KM	\$228.00
713F958	WS707AKM, WS708AKM	\$236.00
BOTTOM RETAINER AND SCREW PACKET		
713F528	907, 908, 910, 907A, 908A	\$150.00
713F998	FE707A, FE708A	\$236.00
713F988	907BKM, 908BKM, 910KM	\$150.00
713F908	WS707AKM, WS708AKM	\$236.00
LOCKING MECHANISM PACKET		
744F258	907BKM, 908BKM, 910KM	\$491.00
744F208	WS707AKM, WS708AKM	\$510.00
1-1/4" CYLINDER COLLAR PACKET¹		
447F43	907BKM ² , 908BKM ² , 910KM ²	\$20.00
610F01	WS707AKM ² , WS708AKM ²	\$32.00
1-1/2" LFIC CYLINDER COLLAR PACKET¹		
609F37	907BKM ² , 908BKM ² , 910KM ²	\$36.00
609F36	WS707AKM ² , WS708AKM ²	\$34.00

Notes: 1. Cylinder collar packets contain a collar & spring washer.
2. Specify finish when ordering packets.

PART NO.	DESCRIPTION	LIST PRICE
ROD EXTENSION KIT (CONCEALED VERTICAL)		
684F427	Rod Extension Kit, 24"	\$95.00
ROD EXTENSION KIT (SURFACE VERTICAL)		
Rod Extension Kit, 2"		
655F15	605, 606, 612, 613, 619, 625, 626, 629, 630	\$94.00
Rod Extension Kit, 6"		
655F16	605, 606, 612, 613, 619, 625, 626, 629, 630	\$108.00
Rod Extension Kit, 12"		
655F17	605, 606, 612, 613, 619, 625, 626, 629, 630	\$113.00
Rod Extension Kit, 24"		
684F42	605, 606, 612, 613, 619, 625, 626, 629, 630	\$115.00
ROD GUIDE COVER		
Rod Guide Cover		
650F63	605, 606, 612, 613, 619, 625, 626, 629, 630	\$37.00
ROD GUIDE PACKET		
Rod Guide Packet		
650F62	606, 612, 613, 626	\$22.00
SCREWS		
605, 606, 611, 612, 613, 619, 625, 626, 629, 630		
429F41	Pack, Armored Front †Order 20- 606, 612, 613, 619	\$5.30
704F63	Packet, Cover 606,612,613,630 finish	\$5.30
656F668	#10-24 x 1/4" PH †Order 100-	\$3.20
650F538	Dogging Assembly †Order 50-	\$3.20
650F518	Latch head to carrier †Order 50-	\$3.20
650F288	Touch bar caps (622 only) †Order 50-	\$3.20
650F508	Trim slide †Order 100-	\$3.20
SCREW PACK, TORX® PIN		
701F60	ED4200(S), ED4800, ED5200(S), ED5800	\$19.00
701F61	ED4400, ED5400, ED5470	\$19.00
701F62	ED5600	\$20.00
701F63	ED5860	\$19.00
SEX NUT PACKET		
652F298	Sex Nut Packet (4 sex nuts)	\$22.00
SHIM KIT		
697F338	ED5200(S)(A), ED5600(A), ED5800(A)	\$124.00
697F348	ED5400(A)	\$147.00
697F358	ED4200(S), ED4800	\$124.00
697F368	ED4400	\$147.00
SPRING, TOUCH PAD		
656F41	Spring, Touch Pad	\$4.30
STRIKE PACKET 622 FINISH ONLY		
650F888	bottom for 1/2" threshold (S09)	\$67.00
650F318	ED4200(S), ED4800	\$65.00
730F778	ED5200(S)(A), ED5202(S)(A)	\$93.00
650L65	ED5600	\$42.00
650L657020	Mortise strike for ED5602(A)	\$42.00
653L157014	Mortise strike for doors with astragal	\$37.00
655F718	ED5200 x S02	\$67.00
653L163016	open back straight lip for 1-3/4" door	\$102.00
653L163020	open back straight lip for 2-1/4" door	\$136.00
653L183016	open back curved lip for 1-3/4" door	\$102.00
653L183020	open back curved lip for 2-1/4" door	\$136.00

†Sold only in multiples of the number indicated. Price is each.

DEVICE PARTS (Cont'd)

PART NO.	DESCRIPTION	LIST PRICE	PART NO.	DESCRIPTION	LIST PRICE
TOP LATCH			TOP STRIKE PACKET		
650F738	Top Latch & Bracket Assembly, ED4800	\$209.00	650F548	Top strike packet	\$88.00
650F718	Top Latch & Bracket Assembly, ED5800	\$211.00	681F708	Top strike packet for ED5470B	\$34.00
650F728	Top Latch & Bracket Assembly, ED5800A	\$226.00	681F778	Top strike for ED5860B	\$38.00
650F558	Top Latch, ED4400, ED5400, ED5470	\$196.00	TOUCH PAD CAP 622 ONLY		
650F568	Top Latch, ED5400A, ED5470B	\$207.00	724F278	Touch Pad Cap, front	\$38.00
681F768	Top Latch, ED5860B	\$236.00	650F095	Touch Pad Cap, rear	\$32.00
681F718	Top Mtg. Plate for ED5470B	\$60.00	TRIM SLIDE NO FINISH		
TOP ROD NO FINISH			650F498	Trim Slide Retainer †Order 10-	\$5.30
650F818	Top Rod Tube, concealed	\$107.00	650F489	Trim Slide, ED4000	\$7.50
650F808	Top Rod, concealed	\$91.00			
Top Rod, surface					
650F60 fin	605, 606, 611, 612, 613, 619, 625, 626, 629, 630	\$142.00			

TRIM PARTS, GRIPS

DESIGN	STANDARD PART NO.	STANDARD PRICE 605, 606, 611, 612, 613, 619, 625, 626, 629, 630	KNURLED PART NO.	KNURLED PART PRICE	ABRASIVE PART NO.	ABRASIVE PART PRICE
A7	652F78		652F79		652F80	
C7	652F66		652F67		652F68	
D7 RHR	652F69		652F70		652F71	
D7 LHR	652F72		652F73		652F74	
E7	652F57		652F58		652F59	
G7	656F45		656F48		656F51	
L7	652F60		652F61		652F62	
N7	652F75		652F76		652F77	
PR7	652F81		652F82		652F83	
R7	652F63		652F64		652F65	
A7M	653F71		653F72		653F73	
C7M	653F59		653F60		653F61	
D7M RHR	653F62		653F63			
D7M LHR	653F65		653F66			
E7M	653F50					
G7M	656F44	\$185.00	656F47	\$255.00	656F50	\$230.00
L7M	653F53		653F54		653F55	
N7M	653F68		653F69		653F70	
PR7M	653F74		653F75		653F76	
R7M	653F56		653F57			
A8	653F05					
C8	652F93				652F95	
D8 RHR	652F96					
D8 LHR	652F99					
E8	652F84		652F85		652F86	
G8	656F46		656F49		656F52	
L8	652F87		652F88		652F89	
N8	653F02		653F03		653F04	
PR8	653F08		653F09		653F10	
R8	652F90				652F92	
08, 014	656F53		n/a		n/a	

†Sold only in multiples of the number indicated. Price is each.

TRIM PARTS, GRIPS, ESCUTCHEONS (Cont'd)

DESIGN	STANDARD PART NO.	STANDARD PRICE 605, 606, 611, 612, 613, 619, 625, 626, 629, 630	KNURLED PART NO.	KNURLED PART PRICE	ABRASIVE PART NO.	ABRASIVE PART PRICE
A9	677F16	\$209.00	652F79	\$278.00	652F80	\$253.00
C9	677F15		652F67		652F68	
D9 RHR	677F26		652F70		652F71	
D9 LHR	677F27		652F73		652F74	
E9	677F13		652F58		652F59	
L9	677F04		652F61		652F62	
N9	677F05		652F76		652F77	
PR9	677F28		652F82		652F83	
R9	677F14		652F64		652F65	
A9M	653F71		653F72		653F73	
C9M	653F59		653F60		653F61	
D9M RHR	653F62		653F63			
D9M LHR	653F65		653F66			
E9M	653F50					
L9M	653F53		653F54		653F55	
N9M	653F68		653F69		653F70	
PR9M	653F74		653F75		653F76	
R9M	653F56		653F57			

DESIGN	PART NO.	LIST PRICE 605, 606, 613, 625, 626
FR9 RHR	698F64	\$209.00
FR9 LHR	698F66	
TS9	698F31	
Z9 RHR	698F68	
Z9 LHR	698F70	
M9	698F33	\$190.00
FR9M RHR	698F65	\$209.00
FR9M LHR	698F67	
TS9M	698F32	
Z9M RHR	698F69	
Z9M LHR	698F71	
M9M	698F34	\$190.00

PART NO.	DESCRIPTION	605, 606, 611, 612, 613, 613E, 619, 625, 626, 629, 630
656F58	x8 cyl. x knob	\$152.00
656F59	x8 cyl. x lever	\$161.00
656F60	x8 plain x knob or thumbturn	\$152.00
656F61	x8 plain x lever	\$161.00
651F00	F450	\$145.00
651F01	F457	
651F10	O14, T14 bottom	\$67.00
656F62	O1410 top	\$145.00
656F63	O1455/59 top	
651F09	T1410 top	\$132.00
651F06	T1450 top	\$127.00
651F08	T1455, T1459 top	\$132.00
651F04	T1457 top	\$127.00
733F41	F950	\$209.00
733F42	F957	
733F43	9M10, M50	
733F05	L910, G910	
733F44	L950, G950	
733F45	L955, G955	
783F06*	L955, G955, L959, G959	
733F46	F9M57	
733F47	L957, G957	
733F48	DL910	
733F49	DL9M10, DL9M50	
733F50	DL955, DL959	
733F51	DL9M55, DL9M57	
733F52	DL957	
733F53	DL950	

†Sold only in multiples of the number indicated. Price is each.

*Not available in 630 Finish.

TRIM PARTS (Cont'd)

PART NO.	DESCRIPTION	LIST PRICE
BUSHING, NYLON		
652F239	Bushing, Nylon †Order 20-	\$5.30
CLUTCH LEVER		
651F538	Clutch Lever †Order 20-	\$5.30
COTTER PIN		
677F098	Cotter Pin †Order 100-	\$3.20
COVER PLATE		
651F858	Cover Plate, x8, O14, T14	\$16.00
CYLINDER COLLAR		
	various	see page 337
GEAR & BLACK HOUSING ASSEMBLY		
651F638	Gear & Black Housing Assembly (all but x750)	\$18.00
651F648	Gear, levers	\$7.50
655F548	Gear, dummy lever	
HEX NUT/BUSHING		
651F398	Hex Nut/Bushing for spring	\$6.40
HOUSING		
651F675	Housing & Cam Assembly, x755, T1355	\$49.00
651F965	Housing & Cam Assembly, x855, x859, O/T1455/59	\$40.00
651F425	Housing, Cylinder, F2, F3, T1357, O/T1457	\$8.50
651F545	Housing, Tailpiece Assembly	\$34.00
706F015	Housing, Cylinder ED5202(S)(A), ED5602(A)	\$9.60
706F005	Housing, Cylinder, Trim, ED5202(S)(A), ED5602(A)	\$48.00
HUB		
652F228	Hub	\$28.00
651F655	Hub, lever	\$8.50
656F64	Hub, G knob	\$8.50
LOCK WASHER		
651F448	for screw post †Order 50-	\$3.20
NUT		
651F888	Nut, Cover Plate †Order 50-	\$3.20
651F928	Nut, Spring Post	\$6.40
PIN		
651F838	Pin, Clutch Lever †Order 50-	\$3.20
651F988	Pin, Groove, 5/32" x 1-1/8" for T1410, T1455, T145	†Order 50- \$3.20
651F587	Pin, Thumbpiece, T13M †Order 20-	\$3.20
PULL		
651F372	Pull, Offset - 605, 606, 611, 612, 613, 619, 625, 626, 629, 630	\$155.00
651F362	Pull, Straight - 605, 606, 611, 612, 613, 619, 625, 626, 629, 630	\$127.00
RACK & TAILPIECE ASSEMBLY		
651F828	x810, x855, x859, O14, T14	\$99.00
652F218	x850	\$86.00
RETAINER, CLUTCH LEVER PIN		
651F898	Retainer, Clutch Lever Pin †Order 100-	\$3.20
RETAINING RING		
651F608	Retaining Ring, T13M †Order 50-	\$3.20
ELECTRIFIED LOCKBODY USED WITH "SAF" & "SEC" ED5600L DEVICES:		
677F768LR 626	LOCK SA-L5 MORT.SAFE LHR	\$846.00
677F768RR 626	LOCK SA-L5 MORT.SAFE RHR	\$846.00
677F778LR 626	LOCK SA-L5 MORT.SEC. LHR	\$846.00
677F778RR 626	LOCK SA-L5 MORT.SEC. RHR	\$846.00
SCREW		
655F028	Screw, Cylinder Mounting †Order 100-	\$3.20
651F878	Screw, FHM-PH #8-32 x 7/16" †Order 50-	\$3.20

PART NO.	DESCRIPTION	LIST PRICE
SCREW (CONT'D)		
656F658	Screw, Function	\$3.20
651F418	Screw, RHM-PH #1/4-20 x 5/8" †Order 50-	\$3.20
651F508	Screw, Tailpiece Plate, PHT-T-PH #6 x 3/8 †Order 50-	\$3.20
SCREW PACKET, MOUNTING		
652F128	1-3/4" - 2" door - 606, 612, 613, 619, 626	\$9.60
652F108	1-3/4" - 2" door - 606, 612, 613, 619, 626	\$7.50
652F118	2-1/4" door - 606, 612, 613, 619, 626	\$7.50
652F138	2-1/4" door - 606, 612, 613, 619, 626	\$9.60
652F148	F3, T13 for 1-3/4" - 2 door - 606, 612, 613, 619, 626	\$13.00
652F158	F3, T13 for 2-1/4" door - 606, 612, 613, 619, 626	\$13.00
SCREW POST		
783F048	Screw Post	\$7.50
SLIDER, THUMBPIECE		
651F498	Slider, Thumbpiece	\$7.50
SPINDLE BRACKET		
652F048	Spindle Bracket, lever	\$7.50
SPINDLE NUT		
651F738	Spindle Nut, x7 †Order 20-	\$3.20
652F098	Spindle Nut, x7M lever †Order 50-	\$3.20
SPINDLE WASHER		
652F068	Spindle washer, G Knob	\$5.30
652F058	Spindle Washer, Levers	\$5.30
SPRING		
651F948	Spring, Extension	\$3.20
651F758	Spring, Grip Return, knob †Order 10-	\$5.30
651F618	Spring, Grip Return, lever, LHR (red)	\$5.30
651F628	Spring, Grip Return, lever, RHR (blue)	
651F938	Spring, Rack, lever †Order 50-	\$3.20
651F478	Spring, Thumbpiece, T13	\$6.40
678F028	Spring, Thumbpiece T13M	\$8.50
651F408	Spring, various trim †Order 20-	\$3.20
651F868	Spring, various trim †Order 50-	\$3.20
TAILPIECE ASSEMBLY		
677F068	1-3/4" door without shim kit	\$44.00
655F698	2" - 2-1/4" door or 1 3/4" door with shim kit - TH9 series trims	\$44.00
655F708	2" - 2-1/4" door or std. door with shim kit - All trims except TH9 series	\$44.00
THIMBLE INSERT		
651F389	Knob & thumbturn †Order 50-	\$3.20
118F299	Lever †Order 100-	\$3.20
THUMBPIECE BRACKET		
651F578	Thumbpiece Bracket, T13M	\$22.00
THUMBPIECE TAB		
651F568	Thumbpiece Tab, T13M	\$4.30
THUMBPIECE 605, 606, 611, 612, 613, 619, 625, 626, 629, 630		
566F50	Thumbpiece, T13, T14	\$52.00
566F51	Thumbpiece, T13M	\$61.00
WASHER		
651F708	Washer under tailpiece †Order 50-	\$3.20
651F848	Washer, Grip †Order 20-	\$3.20

ED7000 Series Crossbar Exit Devices

USA & Canada Prices Effective March 16, 2020

STRIKES FOR CROSSBAR EXIT DEVICES

PART NO.	DESCRIPTION	LIST PRICE
269F73	ED7000 LHR with dogging	\$950.00
269F74	ED7000 RHR with dogging	
269F75	ED7000 LHR less dogging	\$897.00
269F76	ED7000 RHR less dogging	
VERTICAL ROD STRIKES 605, 606, 612, 613, 622, 626, 629		
392F24	Top	\$103.00
392F22	Top	\$82.00
392F28	Bottom flush	\$66.00
392F29	Bottom surface	\$55.00
176F653	Top bracket	\$55.00
304F337	Bottom 630 only	\$37.00
304F347	Bottom 630 only	\$55.00
352F042	Bottom	\$37.00
352F05	Top	\$66.00
361F913	Bottom flush	\$66.00
123F22	Bottom	
183F857	Top 630 only	\$39.00
502F75	Bottom mortised	
502F96	Surface	\$50.00

STRIKES FOR CROSSBAR EXIT DEVICES (Cont'd)

PART NO.	DESCRIPTION	LIST PRICE
CONCEALED VERTICAL ROD STRIKES 605, 606, 612, 613, 622, 626		
503F52	Bottom Strike	\$67.00
503F533	Fire Rated Bottom Strike	\$67.00
RIM EXIT DEVICE STRIKES 605, 606, 612, 613, 622, 626		
142F43	Adj. Packet	\$153.00
467F733	Pack, rim vert. rod	\$103.00
300F71	Packet	\$131.00
499F598	Adj.	\$97.00
MORTISE STRIKES 605, 606, 612, 613, 619, 622, 625, 626		
240L50	Stainless Mortise - LHR 629, 630 only	\$54.00
240L51	Stainless Mortise - RHR 629, 630 only	
411L63	Open Back - RHR	See page 341
411L62	Open Back - LHR	See page 341
LOW PROFILE EXIT DEVICE STRIKES		
416F355	Strike 622 689, 690, 691	\$50.00
436F038	Strike, bottom	\$20.00
487M048589	Top Rod (for 10' Doors)	\$145.00
463F918	Flush Bottom Strike	\$23.00

DEVICE PARTS					
PART NO.	DESCRIPTION	LIST PRICE	PART NO.	DESCRIPTION	LIST PRICE
122F188	Mounting Bracket	\$34.00	164F329	Nylon Washer †Order 50-	\$3.20
122F248	Washer †Order 100-	\$3.20	173F698	Stud	\$3.20
122F413	Lower Rod Guide	\$14.00	173F728	Nut	\$6.40
122F508	Lower Bolt Tube Sub Assembly	\$94.00	175F518	Rod Insert	\$22.00
122F518	Bottom Guide Sub Assembly	\$89.00	183F74	Top Latch Sub Assembly (with top rod doors 6'4" to 8'6")	\$417.00
122F568	Locking Lever	\$26.00	183F75	Top Latch Sub Assembly (with top rod door 8'6" to 10'8")	\$417.00
122F578	Locking Lever	\$18.00	184F825	Shim	\$22.00
122F593	Locking Lever Spring	\$28.00	184F948	Jam Nut	\$7.50
122F608	Locking Hub	\$15.00			
122F618	Locking Hub	\$7.50			
122F639	Spacer Washer (Nylon)	\$3.20			
122F643*	Handle Lever	\$131.00			
123F538	Dogging Key, 3/16" hex	\$4.30			
129F499	Sound Deadener	\$8.50			
129F848	Cylinder Nut	\$8.50			
134F05	Cylinder Collar	See page 337			
140F528	Stud †Order 20-	\$3.20			
141L548	Reinforcing Tube	\$160.00			
141L59	Crossbar				
	605, 606, 611, 612, 613, 619, 622, 625, 626, 629, 630	\$362.00			
142F44*	Adj. Strike	\$85.00			
143F248	Spring †Order 50-	\$3.20			
145F543*	Strike Plate	\$92.00			
148F367	Release Plunger Sub Assembly	\$27.00			
148F448	Mounting Wrench	\$6.40			

DEVICE PARTS (Cont'd)

PART NO.	DESCRIPTION	LIST PRICE
213F117	Top Strike S/A (reveal less 5-1/2") <i>Obsolete</i> 629, 630	\$101.00
200F168	Screw 12-24 x 1/2" FHMS <i>Obsolete</i>	\$3.20
220F498	Screw 1/4-20 x 2" FHMS <i>Obsolete</i>	\$3.20
220F722	Screw 12-24 x 1/2" FHMS-PH <i>Obsolete</i> †Order 20-	\$3.20
220F75	Screw 1/4-20 x 5/8" FHMS-PH	
	606, 619, 622, 625, 626, 630	\$3.20
	605, 611, 512, 613, 629	\$4.30
220F778	Screw 622, CDC, MTD, 613	\$3.20
220F827	Screw 1/4-20 x 1" FHMS-PH	\$4.30
220F848	Screw 12-24 x 1-1/4" FHMS-PH	\$3.20
220F85*	Screw 1/4-20 x 1-1/4" FHMS-PH x Anchor <i>Obsolete</i>	\$4.30
221F948*	Mounting Screw	\$4.30
222F71*	Throughbolt	
224F348	Screw 12 x 1" FHWS †Order 20- <i>Obsolete</i>	\$3.20
224F392	Screw 14 x 1-1/4" FHWS †Order 20- <i>Obsolete</i>	
224F448	Screw 14 x 1-1/2" FHWS <i>Obsolete</i>	\$4.30
224F508	Screw 14 x 2" FHWS †Order 20- <i>Obsolete</i>	\$3.20
225F998	Screw 12 x 1-1/2" OHWS-PH <i>Obsolete</i>	\$3.20
228F188	Roll Pin †Order 100- <i>Obsolete</i>	\$3.20
228F497	Roll Pin (79028-1250343)	\$3.20
228F517	Roll Pin (79028-1250500 St'd) †Order 100-	\$3.20
228F528	Roll Pin †Order 100- <i>Obsolete</i>	\$3.20
228F558	Roll Pin 1/8 x 3/4" †Order 100- <i>Obsolete</i>	\$3.20
228F687	Roll Pin 156 x 9/16" †Order 50-	\$3.20
228F808	Roll Pin 187 x 3/4" †Order 100-	\$3.20
228F817	Roll Pin 187 x 1-15/16" †Order 20-	\$3.20
228F847	Roll Pin 187 x 1-3/8" †Order 20-	\$3.20
243F769	Stop Nut †Order 20- <i>Obsolete</i>	\$3.20
243F798	Spring Lock Washer †Order 100- <i>Obsolete</i>	\$3.20
243F808	1/4-20 x 5/8" FRMS-PH <i>Obsolete</i>	\$4.30
243F85	Top Cover Sub Assembly	\$165.00
	605, 606, 611, 612, 613, 619, 625, 626, 629, 630 <i>Obsolete</i>	
249F33*	1/4-20 NC-2A x 1-1/4" Lg. Phillips OHMS	\$5.30
253F118	Drive Screw †Order 100-	\$3.20
254F73	Screw 8-32 x 3/8" OHMS-PH <i>Obsolete</i>	
	605, 606, 611, 612, 613, 619, 625, 626, 630	\$3.20
255F41*	Screw 12-24 x 2" FHMS-PH	\$6.40
261F288	Screw 8-32 x 3/8" HSS Cone-SOC <i>Obsolete</i>	\$4.30
261F318	Screw 5/16-24 x 1-1/2" FHMS-SOC	
	605, 611, 612, 613, 619, 625, 626, 630	\$4.30
261F54	Cylinder Collar	\$33.00
261F658	Screw 1/4-20 x 1/2" PHMS	\$4.30
262F901	River 3/32" x 5/32" †Order 100- <i>Obsolete</i>	\$3.20

PART NO.	DESCRIPTION	LIST PRICE
264F958	Screw 12-24 x 7/8" RHMS-PH <i>Obsolete</i>	\$3.20
	(Metal Doors) †Order 20-	
268F647	Washer †Order 50-	\$3.20
268F848	Screw 6-32 x 5/8" RHMS †Order 20- <i>Obsolete</i>	\$3.20
268F878	Retainer Ring †Order 20-	
269F048	Cotter Pin †Order 50-	\$3.20
269F058	Lockwasher †Order 100-	\$3.20
269F08	Screw 8-32 x 3/8" FHMS-PH	\$3.20
	605, 606, 611, 612, 613, 619, 625, 626, 630	
	Lever	
269F31	605, 606, 611, 612, 619, 613, 619, 625, 626	\$341.00
269F32	605, 606, 611, 612, 619, 613, 619, 625, 626	
COVER		
269F33	605, 606, 611, 612, 613, 619, 625, 626, 629, 630	\$353.00
269F34	605, 606, 611, 612, 613, 619, 625, 626, 629, 630	\$353.00
269F35	605, 606, 611, 612, 613, 619, 625, 626, 629, 630	\$353.00
269F36	Active Case Less Cover, ED7200 RHR & LHR	\$380.00
	605, 606, 611, 612, 613, 619, 625, 626, 629, 630	
269F378	Hub	\$46.00
269F393	Latch Retractor	\$42.00
269F403	Latch Retractor	\$46.00
269F413	Slide	\$54.00
269F42	Inactive Case S/A, all ED7000	\$378.00
	605, 606, 611, 612, 613, 619, 625, 626, 629, 630	
269F468	Hold Back Sleeve	\$46.00
269F479	Nyliner	\$4.30
269F488	Lever Pivot	\$4.30
269F499	Bushing	\$5.30
269F528	Hub Shank	\$6.40
269F538	Latch Spring	\$4.30
269F549	Button	\$3.20
269F559	Washer †Order 50-	\$3.20
269F569	Washer †Order 50-	
269F578	Spring Washer	\$7.50
269F587	Latch Pin	\$4.30
269F608	Inner Spring	\$7.50
269F91*	Screw Packet	\$104.00
269F92*	Screw Packet	\$77.00
270F01*	Screw Packet	\$104.00
270F02*	Screw Packet	\$80.00
270F11*	Through Bolt	\$5.30
282F325	Caulking Anchor <i>Obsolete</i>	\$5.30
282F357	Caulking Anchor	\$4.30
284F67*	Lever RH <i>Obsolete</i>	\$134.00

*Specify Finish. Ø Subject to availability.

† Sold only in multiples of the number indicated. Price is each.

DEVICE PARTS (Cont'd)

PART NO.	DESCRIPTION	LIST PRICE	PART NO.	DESCRIPTION	LIST PRICE
284F977	Roll Pin †Order 50-	\$3.20	351F72	Bottom Latch Cover 605, 606, 611, 612, 613, 619, 625, 626, 629, 630	\$257.00
291F498	Stop Plate	\$28.00	351F73	Top Latch Cover 605, 606, 611, 612, 613, 619, 625, 626, 629, 630	\$271.00
291F578	Screw 10-31 x 1" FHM-PH †Order 50-	\$3.20	351F797	Top Latch Sub Assembly	\$62.00
293F183	Slide Assembly	\$124.00	351F807	Roll Pin †Order 50-	\$3.20
306F068	Screw 10-24 x 5/16" RHMS-PH †Order 20-	\$3.20	351F823	Top Latch Backplate	\$113.00
306F078	Spring Lockwasher †Order 100-	\$3.20	351F833	Top Latch Slide	
321F907	Dogging Device Sub Assembly	\$50.00	351F849	Spacer	\$11.00
333F519	Screw	\$3.20	351F85*	Top Latch Sub Assembly No Cover	\$429.00
341F318	Shim	\$23.00	351F867	Bottom Latch	\$113.00
351F50*	Active Case - less cover, ED7400 standard		351F873	Latch Link	\$110.00
	606, 612, 619, 622, 626	\$236.00	351F883	Bottom Latch Backplate	\$113.00
	605, 611, 613, 625, 629, 630		351F897	Spring †Order 20-	\$3.20
351F51*	Active Case - less cover, ED74000, ED7401, no bottom rod		351F907*	Bottom Latch Sub Assembly	\$387.00
	606, 612, 619, 622, 626	\$236.00	351F988	Rod Connector Sub Assembly	\$6.40
	605, 611, 613, 625, 629, 630		352F021	Drive Rivet †Order 20-	\$3.20
351F528	10-32 x 7/16" FHUMS-PH Screw †Order 100-	\$3.20	352F068	1/4-20 x 3/4" BHUMS-PH Screw †Order 20-	\$3.20
351F553	Slide Sub Assembly	\$177.00	361F308	Anchor	\$7.50
351F56*	Active Case Sub Ass'y, ED7400 with dogging -RHR	\$973.00	362F498	Nut	\$27.00
351F57*	Active Case Sub Ass'y, ED7400 with dogging -LHR		362F918	Plate	\$8.50
			364F228	Washer	\$7.50
			364F272	Locking Slide	\$31.00
			364F288	Locking Lever Sub Assembly	\$40.00
			364F308	Lifting Lever	\$33.00
			364F36*	Escutcheon Assembly RHR, C4, D4, E4 - MR	\$327.00
			364F37*	Escutcheon Assembly LHR, C4, D4, E4 - MR	
			364F38*	Escutcheon Assembly RHR, C4, D4, E4 - Std	\$342.00
			364F39*	Escutcheon Assembly LHR, C4, D4, E4 - Std	
			365F003	Slide Extension S/A Door 1-3/4"	\$50.00
			365F013	Slide Extension S/A Door 2-1/4"	
			365F033	Slide Extension S/A Door 1-3/4" or Lever Trim	
			365F98*	1/4-20 x 2" OHTS-F-PH Metal Door	\$7.50
				Latch Sub Assembly	
			376F42	611, 612, 613, 619, 625, 626	\$60.00
				605, 606, 629, 630	\$70.00
			378F745	Tenon Sub Assembly	\$48.00

*Specify Finish. Subject to availability.

† Sold only in multiples of the number indicated. Price is each.

DEVICE PARTS (Cont'd)

PART NO.	DESCRIPTION	LIST PRICE	PART NO.	DESCRIPTION	LIST PRICE
392L19*	Adj. Bottom Rod Assembly	\$252.00	468F246	Active Backplate Assembly, RH	\$897.00
393L13-M672*	Top Rod	\$196.00	468F256	Active Backplate Assembly, LH	
399F188	Lower Bolt Assembly	\$391.00	468F266	Active Backplate Assembly, RH	
402F99*	Thumbpiece	\$51.00	468F276	Active Backplate Assembly, LH	
403F035	Slide x4M Trim	\$101.00	468F355	Cylinder housing	\$11.00
403F30*	Washer	\$4.30	480F128	Inactive Backplate Assembly	\$120.00
405F428	Anchor	\$7.50	480F13*	Lever	\$302.00
405F458	Mullion (507) 7'2" door	\$265.00	480F188	Spindle	\$49.00
Ø 405F466	Bottom Plate	\$120.00	480F198	Nut	\$11.00
405F476	Top Plate	\$107.00	480F208	Rollback	\$12.00
405F496	Bottom Plate Assembly		480F28*	Lever & Spindle Assembly	\$281.00
Ø 409F836	Top Plate Assembly		480F30*	Lever & Spindle Assembly	\$281.00
412F133*	Screw, 8-32 x 5/16"	\$4.30	480F33*	Lever & Spindle Assembly	\$285.00
412F157	Lever Pivot	\$14.00	480F375	Slide	\$55.00
412F167	Deadlocking Plunger	\$23.00	482F442	*Bushing	\$62.00
412F451	Inactive Backplate Assembly	\$117.00	482F49*	Escutcheon	
416F818	Stud	\$9.60	482F73*	Escutcheon & Bushing	\$285.00
418F288	Dogging Screw	\$7.50	484F418	Rollback	\$19.00
418F308	Rivet	\$4.30	484F898	Knob Shank Sub Assembly	\$37.00
418F352	Hub	\$54.00	492F195	Slide	\$99.00
418F368	Lever, RH	\$6.40	BLANK PLATE FOR STOCK HOLLOW METAL DOORS		
418F378	Lever, LH		561F29	Blank Plate 14" x 3-1/2" Used on the outside of stock cut-out hollow metal doors where no trim is desired	
420F128*	Screw Packet	\$50.00		605, 606, 612, 613, 619, 625, 626, 630	\$148.00
433F978	Lever Pivot	\$48.00	BLANK FRONTS AND STRIKES FOR STOCK HOLLOW METAL DOORS AND FRAMES		
433F988	Lever Pivot				Steel, USP
434F008	Lever Pivot	\$28.00	077F198	Front, 2-1/4" x 1-1/8"	\$9.60
434F028	Screw 1/4-20 x 3/4" BUHC-SK	\$3.20	334F99	Front, 8" x 1-1/4"	\$23.00
464F028	Mullion (508) 8' door	\$259.00	Ø 236L718018	Strike, 4-7/8" x 1-1/4"	\$9.60
464F915	Active Case Casting only	\$50.00	321F24*	RHR Bracket for P3 trim	\$120.00
467F942	Thumbpiece Lever RH	\$92.00	393L13-M672*	Top Rod	\$196.00
467F952*	Thumbpiece Lever LH		Ø 399F168	Spindle Adapter	\$55.00
468F022*	Lever, inactive RH	\$137.00	399F178	Lower Rod Assembly	\$196.00
468F032*	Lever, inactive LH		402F983	Extension Slide	\$39.00
468F122	Thumbpiece Lever Assembly RH	\$236.00	402F99*	Thumbpiece	\$51.00
468F132	Thumbpiece Lever Assembly LH		408F258	Guide Spring	\$3.20
468F147	Latch Pin Assembly RH	\$92.00	503F533	Bottom Strike	\$67.00
468F157	Latch Pin Assembly LH		503F557	Top Strike	\$63.00
468F162	Lever Assembly RH	\$87.00	503F567	Top Strike - Fire Rated	
468F172	Lever Assembly LH		376F37*	Sex Nut (For 1-3/4 & 2" doors)	\$7.50
468F202*	Lever Assembly RH	\$217.00	MISCELLANEOUS		
468F212*	Lever Assembly LH		148F228	Pin	\$3.20

*Specify Finish. Ø Subject to availability.

† Sold only in multiples of the number indicated. Price is each.

PART NO.	DESCRIPTION	LIST PRICE	PART NO.	DESCRIPTION	LIST PRICE
ALARM DELAY SWITCH			MISCELLANEOUS		
696F318	for M62 option	\$61.00	650F279	Dogging Hole Plug	\$2.20
BAR 689, 690, 691			697F988	Sex Nut Pack (M54)	\$19.00
436F418	for ED8400, 30" door width, with dogging	\$379.00	436F858	Latch Assembly Screw	\$3.20
436F428	for ED8400, 36" door width, with dogging		558F528	Mounting packet for F1 and P8 Trim 689, 690, 691	\$26.00
436F438	for ED8400, 42" door width, with dogging		482F798	ANSI fastening plate packet for G3 Trim No Finish	\$11.00
436F448	for ED8400, 48" door width, with dogging	\$407.00	123F538	Dogging Key, 3/16" hex No Finish	\$4.30
387F218	for ED8200, 30" door width, with dogging	\$356.00	267F348*	Mounting Screw †Order 20-	\$3.20
387F248	for ED8200, 36" door width, with dogging		MOUNTING PACKET 605, 606, 611, 612, 613, 619, 622, 625, 626		
387F278	for ED8200, 42" door width, with dogging		469F67	for F157, P857 trim	\$30.00
387F308	for ED8200, 48" door width, with dogging	\$381.00	469F68	for F150, P150, P850 trim (dummy)	\$17.00
387F638	for ED8200, 30" door width, less dogging	\$349.00	496F68	for P257 trim	\$32.00
387F668	for ED8200, 36" door width, less dogging		496F69	for P250 trim (dummy)	\$30.00
387F698	for ED8200, 42" door width, less dogging		PLATES AND PULLS 689, 690, 691		
387F728	for ED8200, 48" door width, less dogging	\$375.00	436F828	for F1 Trim, plate - no cylinder hole	\$45.00
564F888	for ED8400, 30" door width, less dogging	\$373.00	436F838	for F1 Trim, plate - with cylinder hole	
564F898	for ED8400, 36" door width, less dogging		436F801	for P8 Trim, pull - no cylinder hole	\$51.00
564F908	for ED8400, 42" door width, less dogging		436F811	for P8 Trim, pull - with cylinder hole	
564F918	for ED8400, 48" door width, less dogging	\$400.00	602F151	Pull Grip (Black) for P2 622 Only	\$61.00
564F378	for ED8400A, 30" door width, less dogging	\$373.00	605, 606, 611, 612, 613, 619, 622, 625, 626		
564F408	for ED8400A, 36" door width, less dogging		270F13	Escutcheon for P3 trim without cylinder hole	\$118.00
564F438	for ED8400A, 42" door width, less dogging		492F20	Offset Pull for P1 trim without cylinder hole	\$146.00
564F688	for ED8400A, 48" door width, less dogging	\$400.00	492F21	Offset Pull for P1 trim with cylinder hole	\$168.00
BOTTOM ROD			602F181	Pull Base for P2 trim plate without cylinder hole	\$215.00
436L328557	for ED8400, 40-5/16" Pushbar Height, for Door 7'6" high	\$200.00	602F171	Pull Base for P2 trim plate with cylinder hole	\$236.00
526L518540	for ED8400A		328F80	Pull Tube for P3 trim	\$120.00
BRACKET 605, 606, 611, 612, 613, 619, 622, 625, 626			REAR COVER 689, 690, 691		
321F23	LHR Bracket for P3 trim	\$138.00	603F64	for ED8000 devices purchased AFTER Nov. 1, 1993	\$31.00
321F24	RHR Bracket for P3 trim		ROD GUIDE PACKET SCREW PACKET		
FRAME PLATES			446F208	Rod guide packet	\$39.00
552F598	for ED8400 - RHR	\$181.00	523F038	for ED8200(B) and ED8400(A), Packet for mounting bar & active case with SNB	\$39.00
552F608	for ED8400 - LHR		484F208	for ED8400, Packet for mounting top latch	\$64.00
552F468	for ED8400A - RHR	\$262.00	484F218	for ED8400, Packet for mounting bottom latch	\$27.00
552F478	for ED8400A - LHR		261F308	for ED8200, Latch & Frame Plate Attachment Screw †Order 20-	\$4.30
FRONT COVER			ROD GUIDE PACKET SCREW PACKET (Cont'd)		
564F345	for ED8400 (A) (not handed)	\$52.00	449F828	for ED8200(B) and ED8400 for bar & active case	\$27.00
385F545	for ED8200(B) (not handed)	\$63.00	492F59	Rear Side Screw Packet for P1 trim	\$6.40
564F115	for ED8200A (not handed)	\$76.00	564F128	for ED8200A, Packet for mtg. bar & active case with SNB	\$47.00
KNOB 605, 606, 611, 612, 613, 619, 625, 626			534F008	for ED8400A, Packet for mtg. Top & bottom latch	\$58.00
695F22	for G10 Trim, plain	\$128.00	SHIM KITS		
695F23	for G10 Trim, with cylinder hole	\$126.00	557F928	for ED8200 (B)	\$94.00
LATCH			557F938	for ED8200A	\$94.00
436F258	for ED8400, Top No Finish	\$209.00	557F948	for ED8400	\$155.00
436F298	for ED8400, Bottom No Finish	\$111.00	557F958	for ED8400A	\$155.00
552F368	for ED8200(B) 626	\$130.00	*Specify Finish.		
552F416	for ED8200A	\$307.00	†Sold only in multiples of the number indicated. Price is each.		
525F998	for ED8400A, top	\$224.00			
526F168	for ED8400A, bottom	\$257.00			
LATCH COVER 689, 690, 691					
526F321	for ED8400A, Top or Bottom Latches	\$100.00			
446F231	for ED8400, Top or Bottom Latches	\$86.00			

DEVICE PARTS (Cont'd)

PART NO.	DESCRIPTION	LIST PRICE
STRIKE PACKET		
391F575	for ED8200, Shim used with 1/2" Stop	\$33.00
446F21M	for ED8400, Packet for Top Latch.Strike 605, 606, 611, 612, 613, 622, 625, 626	\$50.00
446F228	for ED8400, Packet for Bottom Latch (Surface Mounting) 625 only	\$39.00
463F928	for ED8400, Packet for Bottom Latch (Flush Mounting) 625 only	\$35.00
386F453	for ED8200(B) Strike Packet 612, 613, 626	\$46.00
468F305	Packet for Rim by Vertical Rod 605, 606, 612, 613, 622, 625, 626, 689, 690, 691	\$39.00
518F067	for ED8200A	\$78.00
526F527	for ED8400A, Packet for Top Strike	\$51.00
526F533	for ED8400A, Packet for Bottom Strike	\$47.00
TOP ROD		
487L048697	for ED8400, 40-5/16" Pushbar Height, for Door 7'6" high	\$111.00
487M048589	for ED8400, 40-5/16" Pushbar Height, for Door 7'6" high to 10' high	\$145.00
526L928759	for ED8400A	\$96.00
CHASSIS, 1-3/4" TO 2-1/4" DOORS NO FINISH		
690F44	Dummy (50)	\$107.00
698F43	Passage (10)	
698F44	Classroom (55)	\$116.00
698F45	Nightlatch (57)	
698F46	Storeroom (59)	
698F51	Classroom - LFIC	\$122.00
698F52	Nightlatch - LFIC	
698F53	Storeroom - LFIC	
MISCELLANEOUS 605, 606, 611, 612, 613,619, 625, 626		
678F25	Rose for X6 trim	\$31.00
585F72	Lever Insert for X6 trim	\$3.20
682F91	Recore Driver Packet	\$7.50
696F05	Mounting Packet	\$5.30
LEVERS ALL FINISHES STANDARD 1-3/8" TO 2-1/4" DOORS		
563F955	N6 design x cylinder or button	\$120.00
563F965	N6 design x emergency key hole	
563F945	N6 design x plain	\$120.00
578F435	N6 x Sargent® cylinder cutout	
563F895	A6 design x cylinder or button	
563F905	A6 design x emergency key hole	\$120.00
563F885	A6 design x plain	
685F515	P6 design x cylinder or button	
685F525	P6 design x emergency key hole	
685F505	P6 design x plain	

PART NO.	DESCRIPTION	LIST PRICE
LEVERS ALL FINISHES LFIC, 1-3/8" TO 2-1/4" DOORS		
585F715	N6 x cylinder (LFIC core 6-pin)	\$120.00
600F415	N6 x cylinder (LFIC core 7-pin)	
596F825	N6 x Best® cylinder cutout	\$120.00
585F705	A6 x cylinder (LFIC core 6-pin)	\$120.00
600F425	A6 x cylinder (LFIC core 7-pin)	
685F535	P6 x cylinder (LFIC core 6-pin)	
685F545	P6 x cylinder (LFIC core 7-pin)	
685F555	P6 x Best cylinder cutout	\$120.00

†Sold only in multiples of the number indicated. Price is each.

DC3000 CLOSER PARTS		
PART NO.	DESCRIPTION	LIST PRICE
TOOLS		
330F10	Hex wrench for closer valve, 3/32"	\$5.30
597F24	Torx tool kit	\$216.00
CLOSER BODIES 600, 689, 690, 691, 693, 696		
540F27	Closer body for DC3200	\$393.00
597F35	Closer body for DC3200 x M71	\$441.00
M71 = Delayed action		
ARMS 600, 689, 690, 691, 693, 696		
688F95	Regular arm	\$137.00
688F77	Regular arm with hold-open	\$203.00
688F95	Top jamb	\$137.00
688F77	Top jamb with hold-open	\$203.00
689F02	Heavy-duty parallel arm	\$206.00
689F01	Heavy-duty parallel arm with hold-open	\$231.00
597F52	Heavy-duty regular arm	\$206.00
689F03	Heavy-duty parallel arm with backstop	\$215.00
689F04	Heavy-duty parallel arm with backstop & hold-open	\$199.00
691F98	Reg. secondary arm assy.	\$48.00
691F99	Deep reveal secondary arm assembly	\$49.00
692F02	Reg. H.D. secondary arm assembly	\$182.00
692F03	Deep reveal H.D. secondary arm assembly	\$314.00
BRACKETS 600, 689, 690, 691, 693, 696		
188F03	Quik-Install™	\$20.00
188F41	Parallel arm	\$7.50
509F49	Parallel arm with hold-open	\$47.00
188F62	Parallel arm offset	\$32.00
188F63	Parallel arm for flush transom	\$47.00
244F17	Regular arm mortise	\$58.00
447F14	Angle Support Bracket and Spacer	\$47.00
DROP PLATES 600, 689, 690, 691, 693, 696		
188F65	For DC3220 x full cover	\$75.00
597F58	For DC3210 x full cover	\$75.00
COVERS 600, 689, 690, 691, 693, 696		
597F78	Full cover and insert packet (standard)	\$46.00
PAINT (PER CAN)		
597F94	Silver Aluminum - 689	\$60.00
597F95	Dark Bronze - 690	
597F96	Light Bronze - 691	
597F97	Satin Brass - 696	

DC5000 CLOSER PARTS		
PART NO.	DESCRIPTION	LIST PRICE
CLOSER BODY 600, 689, 690, 691, 693, 696		
754F68	Closer Body Only	\$502.00
ARMS 600, 689, 690, 691, 693, 696		
754F95	Pull Side Slide Track & Arm Assy., Non-Hold Open	\$207.00
754F96	Pull Side Slide Track & Arm Assy., Hold Open	\$312.00
754F97	Push Side Slide Track & Arm Assy., Non-Hold Open	\$207.00
754F98	Push Side Slide Track & Arm Assy., Hold Open	\$312.00
754F92	Hold Open Assembly	\$40.00
COVER		
754F79	Plastic Cover	\$47.00
DROP PLATE		
754F80	Push side, drop plate	\$50.00
ANGLE BRACKET		
754F93	Stop Mount Track Angle Bracket	\$84.00
SCREW PACKETS		
754F69	Closer Screw Pack	\$12.00
754F70	Spline Screw Pack	\$32.00
754F94	Track Screw Pack	\$16.00
261F298	Hex Key 5/64" †Order 10-	\$4.30

† Sold only in multiples of the number indicated. Price is each.

CLOSER PARTS

PART NO.	DESCRIPTION	LIST PRICE
CLOSER BODIES 600, 689, 690, 691, 693, 696		
689F12	Closer body for DC6200	\$463.00
689F13	Closer body for DC6200 x M71	\$511.00
689F14	Closer body for DC6401	\$463.00
689F15	Closer body for DC6402	
689F16	Closer body for DC6403	
689F17	Closer body for DC6404	
689F18	Closer body for DC6405	
689F19	Closer body for DC6406	
691F52	Closer body for DC6401 x M71	
691F53	Closer body for DC6402 x M71	
691F54	Closer body for DC6403 x M71	
691F55	Closer body for DC6404 x M71	
691F56	Closer body for DC6405 x M71	
691F57	Closer body for DC6406 x M71	
M71 = Delayed action		
ARMS 600, 689, 690, 691, 693, 696		
688F95	Regular arm, consists of:	\$137.00
	688F99 main arm & tube assembly	\$87.00
	688F98 rod & shoe assembly	\$37.00
	688F92 hex screw pkg.	\$15.00
688F77	Regular arm with hold-open (A1), consists of:	\$203.00
	691F92 main arm & rod assy	\$81.00
	540F40 hold-open bracket assembly	\$122.00
689F02	Heavy duty parallel arm (A3)	\$206.00
689F01	Heavy duty parallel arm with hold-open (A2)	\$231.00
597F52	Heavy duty regular arm (A10)	\$206.00
689F03	Heavy duty parallel arm with backstop (A4)	\$215.00
689F04	Heavy duty parallel arm with backstop & hold-open (A5)	\$199.00
615F52	HD Spring stop for Dr. width. 28"-32" (A11)	\$206.00
615F54	Unitrol® for Dr. width. 33"-41	
615F56	Unitrol® for Dr. width. 42"-48"	
615F51	Unitrol®/HO for Dr. width. 28"-32" (A12)	
615F53	Unitrol®/HO for Dr. width. 33"-41"	
615F55	Unitrol®/HO for Dr. width. 42"-48"	\$231.00
691F96	Heavy-duty offset arm (A13)	\$136.00
754F16	DC6230, DC6430 pull side - arm only	\$105.00
754F10	DC6230, DC6430 - track only (hold-open)	\$312.00
754F09	DC6230, DC6430 - track only (non hold-open)	\$207.00
754F44	DC6230, DC6430 pull side track assembly, non-hold open	\$441.00
754F45	DC6230, DC6430 pull side track assembly, hold open	\$552.00
754F12	DC6240, DC6440 push side track & arm (non hold open)	\$308.00
754F14	DC6240, DC6440 - track only (non hold-open)	\$207.00
754F13	DC6240, DC6440 track & arm (hold-open)	\$417.00
754F15	DC6240, DC6440 - track only (hold-open)	\$312.00
754F16	DC6240, DC6440 - arm only (hold-open)	\$105.00
691F72	Deep reveal arm (7-1/4" max), consists of:	\$125.00
	688F99 main arm and arm tube assy	\$87.00
	691F75 rod & shoe assembly	\$16.00

PART NO.	DESCRIPTION	LIST PRICE
ARMS 600, 689, 690, 691, 693, 696		
691F74	Deep reveal arm w/hold-open (7-1/4" max), consists of:	\$166.00
	691F95 main arm & rod assy- deep reveal	\$166.00
	540F40 hold-open bracket assy.	\$122.00
615F58	Reinforcing bracket	\$39.00
615F59	Deep reveal reinforcing kit	\$52.00
615F60	Flush partition bracket	\$38.00
692F04	Friction, Hold Open Arm RH	\$126.00
692F05	Friction, Hold Open Arm LH	\$126.00
692F00	Reg. Secondary Arm Assy.	\$48.00
692F01	Top Jamb Secondary Arm Assy.	\$49.00
692F02	Reg. H.D. Secondary Arm Assy.	\$182.00
692F03	Deep Reveal HD. Secondary Arm Assy.	\$314.00
BRACKETS 600, 689, 690, 691, 693, 696		
188F03	Quik-Install™	\$20.00
188F41	Parallel arm	\$7.50
509F49	Parallel arm with hold-open	\$47.00
188F63	Parallel arm for flush transom	\$47.00
188F62	Parallel arm offset	\$32.00
244F17	Regular arm mortise	\$58.00
447F14	Angle support	\$47.00
499F30	Flush transom	\$30.00
691F78	Spacer	\$6.40
COVERS 600, 689, 690, 691, 693, 696		
597F78	Full cover and insert pkt. (standard)	\$46.00
603F55	Full metal cover RH/LHR	\$51.00
603F57	Full metal cover LH/RHR	
261F95	Cover screw pack	\$6.40
DROP PLATES 600, 689, 690, 691, 693, 696		
188F65	For DC6220 x full cover	\$75.00
	For DC6420 x full cover	
597F58	For DC6210, DC6410, DC6240, DC6440 x full cover	\$75.00
597F59	For DC6230, DC6240, x full cover	\$75.00
	For DC6430, DC6440 x full cover	
BLADE STOP SPACER		
597F92	1/2" Spacer block	\$23.00
597F93	5/8" Spacer block	\$38.00
SCREW PACKETS 600, 689, 690, 691, 693, 696		
691F93	Standard Screw Pack	\$14.00
691F94	Standard Screw Pack w/ Sex Nuts	\$22.00
468F34	SNB for 1-3/4" door	\$13.00
691F89	Torx® Screw Pack	\$32.00
691F90	Torx Screw Pack with Sex Nuts	\$36.00
597F24	Torx® tool kit	\$216.00
754F43	Screw pack (push or pull track)	\$20.00
PAINT (PER CAN)		
597F94	Silver Aluminum - 689	\$60.00
597F95	Dark Bronze - 690	
597F96	Light Bronze - 691	
597F97	Satin Brass - 696	

CLOSER PARTS

PART NO.	DESCRIPTION	LIST PRICE
CLOSER BODIES		
754F21	Closer body for DC8200	\$513.00
754F26	Closer body for DC8200 x M71	\$562.00
ARMS		
688F95	Regular arm, consists of:	\$137.00
	688F99 main arm & tube assembly	\$87.00
	688F98 rod & shoe assembly	\$37.00
	688F92 hex screw pkg.	\$15.00
688F77	Regular arm with hold-open (A1), consists of:	\$203.00
	691F92 main arm & rod assy	\$81.00
	540F40 hold open bracket assembly	\$122.00
689F02	Heavy-duty parallel arm (A3)	\$206.00
689F01	Heavy-duty parallel arm with hold-open (A2)	\$231.00
597F52	Heavy-duty regular arm (A10)	\$206.00
689F03	Heavy-duty parallel arm with backstop (A4)	\$215.00
689F04	Heavy-duty parallel arm with backstop & hold-open (A5)	\$199.00
615F52	Unitrol® - Dr. width 28"-32" (A11)	\$206.00
615F54	Unitrol® - Dr. width 33"-41" (A11)	
615F56	Unitrol® - Dr. width 42"-48" (A11)	
615F51	Unitrol® w/ Hold Open - Dr. width 28"-32" (A12)	\$231.00
615F53	Unitrol® w/ Hold Open - Dr. width 33"-41" (A12)	
615F55	Unitrol® w/ Hold Open - Dr. width 42"-48" (A12)	
691F96	Heavy-duty offset arm (A13)	\$136.00
692F04	Heavy duty friction hold open, RH (A14)	\$126.00
692F05	Heavy duty friction hold open, LH (A14)	\$126.00
754F09	Pull side track only, non-hold open	\$207.00
754F10	Pull side track only, hold open	\$312.00
754F12	Push side track & arm, non-hold open	\$308.00
754F13	Push side track & arm, hold open	\$417.00
754F14	Push side track only, non-hold open	\$207.00
754F15	Push side track only, hold open	\$312.00
754F16	Slide track assembly (non-hold open or hold open)	\$105.00
691F72	Deep reveal arm (7 1/4" max) consists of:	\$125.00
	688F99 main arm and arm tube assy	\$87.00
	691F75 rod & shoe assembly	\$16.00
691F74	Deep reveal arm with hold-open (7 1/4" max), consists of:	\$166.00
	691F95 main arm & rod assy- deep reveal	\$37.00
	540F40 hold open bracket assy.	\$122.00
615F58	Reinforcing bracket	\$39.00
615F59	Deep reveal reinforcing kit	\$52.00
615F60	Flush partition bracket	\$38.00

PART NO.	DESCRIPTION	LIST PRICE
BRACKET		
754F18	Quik-Install™	\$22.00
188F41	Parallel arm	\$7.50
509F49	Parallel arm with hold-open	\$47.00
188F63	Parallel arm for flush transom	\$47.00
188F62	Parallel arm offset	\$32.00
244F17	Regular arm mortise	\$58.00
447F14	Angle support	\$47.00
499F30	Heavy duty parallel arm flush transom bracket	\$30.00
COVERS		
754F84	Full ABS cover	\$32.00
754F22	Full metal cover RH/LHR	\$70.00
754F23	Full metal cover LH/RHR	
754F17	Cover screw pack	\$6.40
DROP PLATES		
754F20	For DC8200 (regular)	\$92.00
754F24	For DC8200 (with concealed holder)	\$92.00
	For DC8220 (top jamb)	
754F25	For DC8210 (parallel)	\$92.00
	For DC8230 (pull side track)	
	For DC8240 (push side track)	
BLADE STOP SPACER		
597F92	1/2" Spacer block	\$23.00
597F93	5/8" Spacer block	\$38.00
SCREW PACKETS		
754F37	Standard screw pack	\$15.00
754F29	Standard screw pack (includes sex nuts)	
754F30	SNB for 1-3/4" door	\$19.00
754F38	Torx® screw pack	\$46.00
754F34	Torx screw pack (includes sex nuts)	
597F24	Torx® tool kit	
754F35	Main arm screw & washer	\$7.50
RETROFIT PLATES		
754F36	To Replace DC6000 (Reg. Arm)	\$102.00
754F46	To Replace DC6000 (Par. Arm or Top Jamb)	\$102.00

PART NO.	DESCRIPTION	LIST PRICE
DC62900 SERIES ELECTROMECHANICAL CLOSERS		
689F12	DC6000 Closer Body	\$463.00
188F03	Quik-Install Bracket	\$20.00
597F78	Full Cover	\$46.00
603F55	Full Metal Cover RH	\$51.00
603F57	Full Metal Cover LH	\$51.00
692F24	Standard Arm Assembly	\$101.00
692F25	Adjusting Head and Tube Assembly	\$127.00
692F14	Slide Assembly	\$109.00
692F15	Arm Stud Clip	\$11.00
692F16	Track Assembly End Cap	\$8.50
692F17	Solenoid Block Assembly, 24V	\$325.00
692F19	Adjusting Rod Assembly	\$52.00
692F20	Arm Stud	\$7.50
692F21	Retaining Ring	\$4.30
692F23	Arm Length Adjusting Screw	\$3.20
754F02	Double Egress Arm, RH	\$185.00
754F03	Double Egress Arm, LH	\$185.00
754F04	Adjusting Head and Tube Assembly, RH	\$125.00
754F05	Adjusting Head and Tube Assembly, LH	\$125.00
754F52	Track Assy. (Hinge Side) Master or support units	\$404.00
754F53	Track Assy. (Stop Side) Master or support units	
754F54	Hook-Up Board, Master or Support, 24V	\$132.00
754F55	Hook-Up Board, Master or Support, 120V	\$198.00
754F56	Hook-Up Box, Master unit, 24V, push side	\$350.00
754F57	Hook-Up Box, Master unit, 120V, push side	
754F58	Hook-Up Box, Support unit, 24V, push side	\$338.00
754F59	Hook-Up Box, Support unit, 120V, push side	
754F61	Hook-Up Box, Master unit, 24V, pull side	\$350.00
754F62	Hook-Up Box, Master unit, 120V, pull side	
754F63	Hook-Up Box, Support unit, 24V, pull side	\$350.00
754F64	Hook-Up Box, Support unit, 120V, pull side	
754F66	Fuse	\$20.00
754F71	Hook-Up Box Cover Kit (included cover & screws), Master	\$350.00
754F72	Hook-Up Box Cover Kit (included cover & screws), Support	\$61.00
754F73	Smoke Detector Board	\$522.00

PART NO.	DESCRIPTION	LIST PRICE
DC46920 SERIES ELECTROMECHANICAL DOOR HOLDER AND CLOSER		
494F77	Arm Assembly "Pull side"	\$212.00
494F76	Arm Assembly "Push side"	
494F74	Holder - 120VAC	\$453.00
494F75	Holder - 24VAC/DC	\$453.00
494F72	Holder cover - Non Detector	\$173.00
494F92	System plug - 24VDC	\$105.00
494F94	Wire harness - 24VDC	\$86.00

PART NO.	DESCRIPTION	LIST PRICE
Access 800® AC2 Series		
794F509	Gaskets Exit device - Reader	\$12.00
794F519	Gaskets Exit device trim	\$12.00
794F529	Gaskets Cylindrical lock	\$16.00
794F539	Gaskets Mortise lock	\$16.00

PART NO.	DESCRIPTION	LIST PRICE
Motorized		
789F929	ECOFLEX, Motor SUB Assembly	\$141.00
728F709	Harness Fail Safe / Fail Secure	\$18.00
789F859	Motor Mortise ECOFLEX	\$114.00
728F759	ECOFLEX ET Harness A800 AC2	\$18.00
789F869	ECOFLEX ET Link Harness IN100	\$18.00
728F799	ECOFLEX ET Link Harness A800 WI1 & IP1	\$18.00
789F879	ECOFLEX ET Link Harness A700 PIP1, PWI1, IN120, IN220	\$18.00
728F809	ECOFLEX ET Link Harness A700 PAC1	\$18.00
728F939	ECOFLEX ET Link Harness A600 & SE LP10	\$18.00
728F799	ECOFLEX ET Ground Wire A800 WI1, IP1	\$18.00

Part Number	Page	Part Number	Page	Part Number	Page	Part Number	Page	Part Number	Page
188F41	385	083L96M048	370	141F84*	377	171F909	377	200F168	378
188F62	385	092F789	370	141F86*	377	173F446	377	201F188	370
188F63	385	095F351	377	141F87*	377	173F456	377	206F578	359
244F17	385	102F198	370	141L548	377	173F698	377	207F558	377
447F14	385	102F278	370	141L59	377	173F728	377	207F64*	377
499F30	385	102F378	370	142F16*	377	173F798	342	207F68*	377
509F49	385	103F448	370	142F43	376	174F797	377	207F69*	377
597F92	385	103F458	370	142F44*	377	174F807	377	209F55*	377
597F93	385	114F678	370	143F248	377	175F518	377	213F107	377
712F305	361	118F299	375	143F25	377	176F653	376	213F117	378
712F315	361	120F558	377	143F265	377	183F74	377	217F422	341
712F445	361	120F768	346	143F42*	377	183F75	377	217F43	342
754F17	385	120F768	358	143F43*	377	183F857	376	217F432	341
754F18	385	120F768	362	143F52*	377	184F57	377	217F44	342
754F22	385	120F768	364	143F833	377	184F825	377	217F442	341
754F23	385	120F768	364	144F298	370	184F948	377	217L13	358
754F30	385	120F768	366	144F308	370	184F97*	377	217L13	364
754F36	385	120F768	367	144F33	369	185F558	377	217L13	366
754F38	385	120F768	368	144F34	369	186F23	377	217L13	368
754F46	385	120F768	368	144F888	370	186F748	342	217L13M016	362
754F84	385	120F768	370	145F328	370	186K75	340	217L13M016	364
799F655	361	121F012	342	145F543*	377	187F213	377	217L13M016	367
019F137	369	121K10	340	146F788	342	187F887	377	217L13M016	368
021F688	342	121K11	340	146K80	340	187F897	377	217L13M018	362
021F718	342	122F188	377	147F078	369	188F03	383	217L13M018	364
022F723	370	122F248	377	147F838	377	188F03	383	217L13M018	367
022F80	369	122F413	377	147F849	377	188F03	384	217L13M018	368
025F722	342	122F508	377	147F878	377	188F03	386	217L13M020	362
025F858	364	122F518	377	147F888	377	188F41	383	217L13M020	364
025F858	366	122F568	377	148F157	377	188F41	383	217L13M020	367
026F757	341	122F578	377	148F17	377	188F41	384	217L13M020	368
041F478	342	122F593	377	148F228	377	188F62	383	217L13M022	362
060F053	370	122F608	377	148F367	377	188F62	383	217L13M022	364
060F338	369	122F618	377	148F448	377	188F62	384	217L13M022	367
060F428	369	122F639	377	156F43	369	188F63	383	217L13M022	368
067F428	369	122F643*	377	156F648	370	188F63	383	217L13M024	362
070F428	369	123F22	376	156F658	370	188F63	384	217L13M024	364
070F438	369	123F538	377	156F837	369	188F65	384	217L13M024	367
071F628	369	123F538	381	157F11	369	188F738	370	217L13M024	368
071F638	369	129F499	377	158F062	342	188F758	370	217L13M028	362
071F673	370	129F848	342	158F528	377	193K09	340	217L13M028	364
077F198	380	129F848	377	158F538	377	193K10	340	217L13M028	367
078F078	369	131F278	369	158F548	377	193K11	340	217L13M028	368
079F00	345	134F05	343	158F558	377	194F228	369	217L13M032	362
079F02	345	134F05	377	159F367	341	195F67	377	217L13M032	364
081F778	369	135F108	342	164F329	377	195K68	340	217L13M032	367
082L67	370	135F192	342	166F347	377	197F347	342	217L13M032	368
083L96M032	370	138F888	369	168F818	370	197F357	342	217L13M036	362
083L96M034	370	140F528	377	171F468	341	197F527	341	217L13M036	364
083L96M036	370	140F978	369	171F798	369	197K51*	340	217L13M036	367
083L96M040	370	141F418	377	171F896	377	198F71	369	217L13M036	368

Part Number	Page	Part Number	Page	Part Number	Page	Part Number	Page	Part Number	Page
217L13M040	362	236L72M044FIN	346	268F848	378	291F498	379	334K01	340
217L13M040	364	236L72M048FIN	346	268F878	378	291F578	379	335F988	370
217L13M040	367	236L75M020	370	269F048	378	292K95	340	340L60M018FIN	347
217L13M040	368	240L08018	370	269F058	378	292K96	340	340L60M020FIN	347
217L13M044	362	240L08020	370	269F08	378	292K97	340	340L60M022FIN	347
217L13M044	364	240L08022	370	269F088	345	292K98	340	340L60M024FIN	347
217L13M044	367	240L50	376	269F098	354	292K99	340	340L60M028FIN	347
217L13M044	368	240L51	376	269F31	378	293F183	379	340L60M032FIN	347
217L13M048	362	242F508	370	269F32	378	293K00	340	340L60M036FIN	347
217L13M048	364	243F769	378	269F33	378	293K01	340	340L60M040FIN	347
217L13M048	367	243F798	378	269F34	378	293K02	340	340L60M044FIN	347
217L13M048	368	243F808	378	269F35	378	293K03	340	340L60M048FIN	347
219F888	342	243F85	378	269F36	378	293L14	370	340L61M018FIN	347
220F498	378	244F17	383	269F378	378	300F688	355	340L61M020FIN	347
220F718	359	244F17	383	269F393	378	300F71	376	340L61M022FIN	347
220F722	378	244F17	384	269F403	378	301F567	369	340L61M024FIN	347
220F75	378	244F647	370	269F413	378	303F242	370	340L61M028FIN	347
220F778	378	245K37	340	269F42	378	303F25	343	340L61M032FIN	347
220F827	378	249F33*	378	269F468	378	304F337	376	340L61M036FIN	347
220F848	378	249F768	370	269F479	378	304F347	376	340L61M040FIN	347
220F85*	378	249F773	370	269F488	378	305F318 Fin	359	340L61M044FIN	347
221F948*	378	250F088	342	269F499	378	306F068	379	340L61M048FIN	347
222F71*	378	251F198	370	269F528	378	306F078	379	341F318	379
222F85	370	252F82	343	269F538	378	310F488	342	342F032	370
223F29	370	253F118	378	269F549	378	314F887	341	342F052	369
224F008*	367	253F758	342	269F559	378	314F987	341	351F50*	379
224F348	378	253F768	342	269F569	378	314F997	342	351F51*	379
224F392	378	253F778	342	269F578	378	315F93 Fin*	362	351F528	379
224F448	378	253F858	342	269F587	378	315F94 Fin*	362	351F553	379
224F508	378	253F97	343	269F608	378	318F64	347	351F56*	379
225F998	378	253K66	340	269F73	376	318F65	347	351F57*	379
228F188	378	253K67	340	269F74	376	318F66	347	351F72	379
228F348	370	254F73	378	269F75	376	318F67	347	351F73	379
228F497	378	255F41*	378	269F76	376	318F68	347	351F797	379
228F517	378	255F53	343	269F808	359	318F69	347	351F807	379
228F528	378	255F54	344	269F91*	378	320F442	342	351F823	379
228F558	378	261F118	370	269F92*	378	320F442	370	351F833	379
228F687	378	261F288	378	270F01*	378	321F23	381	351F849	379
228F808	378	261F298	370	270F02*	378	321F24	381	351F85*	379
228F817	378	261F298	383	270F11*	378	321F24*	380	351F867	379
228F847	378	261F308	381	270F13	381	321F907	379	351F873	379
236L72M014FIN	346	261F318	378	270F15	343	328F80	381	351F883	379
236L72M016FIN	346	261F54	378	281F272	342	329F998	342	351F897	379
236L72M018FIN	346	261F658	378	282F325	378	330F10	383	351F907*	379
236L72M020FIN	346	261F95	384	282F357	378	333F519	379	351F988	379
236L72M022FIN	346	262F901	378	283F81	370	333F998	342	352F021	379
236L72M024FIN	346	264F698	351	284F138	342	334F128	342	352F042	376
236L72M028FIN	346	264F958	378	284F67*	378	334F238	342	352F05	376
236L72M032FIN	346	267F348*	381	284F977	379	334F99	380	352F068	379
236L72M036FIN	346	267F97	343	286F507	369	334F998	345	353F868	342
236L72M040FIN	346	268F647	378	287F608	370	334K00	340	354F198	342

Part Number	Page	Part Number	Page	Part Number	Page	Part Number	Page	Part Number	Page
361F308	379	392F24	376	407T414270 3L	341	423F58	345	437F41	348
361F913	376	392F28	376	407T414298 4L	341	423L71	370	437F42	348
362F153	342	392F29	376	407T414326 5L	341	424F428	376	438F37	348
362F432	342	392L19*	380	407T414354 6L	341	424F438	376	438F38	348
362F498	379	393L13-M672*	380	407T424242 2R	341	424F838	370	438F418	342
362F918	379	393L13-M672*	380	407T424270 3R	341	426F52	349	438F428	342
364F228	379	394F198	370	407T424298 4R	341	427F06	348	438F90	351
364F272	379	399F178	380	407T424326 5R	341	427F078	348	439F25	348
364F288	379	399F188	380	407T424354 6R	341	427F36	349	439F26	348
364F308	379	402F29	345	407T434158	341	427F37	349	439F27	348
364F36*	379	402F30	345	407T434193	341	427F39	349	439F33	355
364F37*	379	402F31	345	408F258	380	427F43	349	439F34	355
364F38*	379	402F33	345	408K45	340	427F45	349	439F35	355
364F39*	379	402F34	345	409K12*	340	427F47	349	442F952	369
365F003	379	402F35	345	411L62	376	428F32	348	444F748	342
365F013	379	402F738	345	411L62M016FIN	347	428F33	348	444F758	342
365F033	379	402F983	380	411L62M018FIN	347	428F34	348	444K87	340
365F958	342	402F99*	380	411L62M020FIN	347	428F66	343	444K88	340
365F968	342	402F99*	380	411L63	376	429F08	346	444K89	340
365F98*	379	403F035	380	411L63M016FIN	347	429F317	354	444K94	340
366F70	344	403F30*	380	411L63M018FIN	347	429F41	346	444K96	340
368F918	342	403F302 Fin	359	411L63M020FIN	347	429F41	372	444K97	340
370F29	343	403F568	346	412F133*	380	430F47	351	444K98	340
370F31	343	403F677	345	412F157	380	432F86	355	444K99	340
370F33	344	404F858	346	412F167	380	433F48	350	445F318	355
370F35	344	404F868	345	412F451	380	433F49	350	445F82	354
376F37*	377	405F428	380	413F488	342	433F76	355	445F83	354
376F42	379	405F458	380	413F498	342	433F77	355	445F84	354
377F308	352	405F476	380	415F16	369	433F78	355	445F85	355
377F80	350	405F496	380	415K73	340	433F978	380	445F869	354
378F745	379	405F772	370	415K74	340	433F988	380	446F208	381
378K18	340	405L138M018FIN	347	416F355	376	434F008	380	446F21M	382
379F805	342	405L138M020FIN	347	416F38	370	434F028	380	446F228	382
381F30	369	405L138M022FIN	347	416F39	343	435F00	351	446F231	381
383F82	350	405L148M018FIN	347	416F49	346	436F038	376	446F572	342
384F03	354	405L148M020FIN	347	416F818	380	436F177	346	446F582	342
384F11	350	405L148M022FIN	347	416F84	346	436F258	381	446K68	340
385F545	381	406F438	342	416K07	340	436F298	381	447F14	383
386F453	382	407K63	340	416K08	340	436F418	381	447F14	383
387F218	381	407K64	340	418F288	380	436F428	381	447F14	384
387F248	381	407K65	340	418F308	380	436F438	381	447F24	354
387F278	381	407T314097 2L	341	418F352	380	436F448	381	447F25	354
387F308	381	407T314125 3L	341	418F368	380	436F801	381	447F41	343
387F638	381	407T314153 4L	341	418F378	380	436F811	381	447F42	343
387F668	381	407T324097 2R	341	420F128*	380	436F828	381	447F43	343
387F698	381	407T324125 3R	341	422F88	343	436F838	381	447F43	372
387F728	381	407T324153 4R	341	422L842144	370	436F858	381	447F44	344
391F575	382	407T334097 2S	341	422L848144	370	436L328557	381	447F45	344
391F658	344	407T334125 3S	341	423F54	345	437F26	348	447F46	344
391F658	352	407T334153 4S	341	423F55	345	437F28	348	449F828	381
392F22	376	407T414242 2L	341	423F57	345	437F40	348	461F108	342

Part Number	Page	Part Number	Page	Part Number	Page	Part Number	Page	Part Number	Page
463F918	376	480F198	380	487K21	340	496F34	369	544F39	351
463F928	382	480F208	380	487K38	340	496F68	381	544F40	351
464F028	380	480F28*	380	487L048697	382	496F69	381	544F41	351
464F915	380	480F30*	380	487M048589	376	496F718	370	544F42	351
464K97	340	480F33*	380	487M048589	382	497F528	354	544F43	350
465F57	346	480F375	380	488F00	351	498F928	355	544F44	351
466F229	346	480F68	367	488F01	351	499F30	384	544F45	351
466F279	370	480F688 Fin	362	488F03	350	499F598	376	544F46	350
466F40	348	480F69	370	488F04	350	499F828	354	544F76	349
466F41	348	480F70	370	488F05	350	499F838	354	544F77	349
466F42	348	480F708	370	488F07	350	499F848	354	544F79	349
466F45	348	481K19	340	488F088	342	502F75	376	544F80	349
466F46	348	481K28	340	488F088	348	502F96	376	544F82	349
466F47	348	482F37	348	488F09	346	503F52	376	544F83	349
466F50	348	482F442	380	488F108	342	503F533	376	544F84	349
466F51	348	482F49*	380	488F108	348	503F533	380	544F85	349
466F52	348	482F73*	380	488F27	348	503F557	380	544F87	349
466F73	348	482F798	381	488F31	348	503F567	380	544F88	349
466F74	348	483F118	352	488F928	342	506F57	344	544F89	349
466F75	348	483F30	348	488K84	340	509F49	383	544F91	349
467F338	370	483F34	348	488K85	340	509F49	383	544F92	349
467F345	370	483F35	348	488K98	340	509F49	384	544F93	349
467F358	370	483F36	348	488K99	340	511F51	348	544F94	350
467F36	370	483F79	354	489F028	342	511F52	348	544F95	350
467F378	370	483F80	354	489F882	369	518F067	382	544F96	350
467F733	376	483F81	354	489F892	369	518K73	340	544F97	350
467F942	380	483F82	354	489K49	340	518K74	340	544F98	350
467F952*	380	483F83	354	490F558	342	518K75	340	544F99	350
468F022*	380	483F84	354	492F195	380	518K76	340	545F00	350
468F032*	380	483K01	340	492F20	381	518K77	340	545F42	350
468F122	380	484F208	381	492F21	381	519F09	355	545F43	350
468F132	380	484F218	381	492F59	381	519F10	355	545F44	350
468F147	380	484F418	380	492K90	340	519F11	355	545F45	350
468F157	380	484F74	346	492K91	340	519F12	355	545F79	349
468F162	380	484F76	351	492K92	340	520F358	342	545F80	349
468F172	380	484F898	380	493F31	354	522F932	342	545F81	349
468F202*	380	484F90	350	493F34	354	523F038	381	545F82	349
468F212*	380	484F918	342	493F76	340	523K21	340	545F83	349
468F246	380	484F928	342	493F77	340	525F998	381	545F84	349
468F256	380	484F938	342	493F78	340	526F168	381	545F85	349
468F266	380	484F948	342	494F72	386	526F321	381	545F86	349
468F276	380	484F958	342	494F74	386	526F527	382	545F87	349
468F305	382	484F968	342	494F75	386	526F533	382	545F88	349
468F34	384	485F74	349	494F76	386	526L518540	381	546F978	341
468F355	380	487F08	354	494F77	386	526L928759	382	549F352	369
468K87	340	487K10	340	494F86	386	534F008	381	549F362	369
469F67	381	487K11	340	494F92	386	534K25	340	549F52	343
469F68	381	487K13	340	494F93	386	540F27	383	552F368	381
480F128	380	487K15	340	494F94	386	544F13	351	552F416	381
480F13*	380	487K17	340	496F32	369	544F14	351	552F468	381
480F188	380	487K19	340	496F33	369	544F38	351	552F478	381

Part Number	Page	Part Number	Page	Part Number	Page	Part Number	Page	Part Number	Page
552F598	381	574F29 x574F25	368	585K46	340	596F638	367	599F389	342
552F608	381	574F29 x574F26	368	586F16	361	596F66	361	599F91	363
553F484 x length	341	574F30	368	586F17	361	596F67	361	599F91	365
553F492 x length	341	574F30 x574F25	368	586F18	361	596F68	361	599F92	363
553F502 x length	341	574F30 x574F26	368	586F51 Fin	362	596F825	360	599F92	365
556F558	367	574F55	368	586F512	366	596F825	382	599F93	363
557F29	350	574F56	368	586F80	361	596F879	342	599F93	365
557F928	381	574K05	340	586F81	361	596F898	342	599F94	363
557F938	381	574K07	340	586F82	361	596K29	340	599F94	365
557F948	381	578F435	360	586F86	361	596K30	340	599F95	363
557F958	381	578F435	382	586F87	361	596K31	340	599F95	365
558F528	381	579F11	368	586F88	361	596K32	340	599F96	363
559K94	340	579K14	340	586L19	358	597F24	383	599F96	365
559K95	340	580F38	368	586L19	366	597F24	384	599F97	363
561F29	380	580F387	368	586L19M016	362	597F24	385	599F97	365
562F402	342	580K99	340	586L19M016	367	597F35	383	599F98	363
562F422	342	581F96	355	586L19M016	368	597F52	383	599F98	365
563F885	360	582F112	369	586L19M018	362	597F52	385	599F99	363
563F885	382	582F122	369	586L19M018	367	597F52	384	599F99	365
563F895	360	582F132	369	586L19M018	368	597F58	384	600F00	365
563F895	382	582F142	369	586L19M020	362	597F59	384	600F00	363
563F905	360	582F298	342	586L19M020	367	597F78	383	600F01	365
563F905	382	584F46	354	586L19M020	368	597F78	384	600F01	363
563F945	360	585F312	342	586L19M022	362	597F78	386	600F02	363
563F945	382	585F327	341	586L19M022	367	597F92	384	600F02	365
563F955	360	585F337	342	586L19M022	368	597F93	384	600F03	363
563F955	382	585F358	342	586L19M024	362	597F94	383	600F03	365
563F965	360	585F367	342	586L19M024	367	597F94	384	600F04	363
563F965	382	585F377	342	586L19M024	368	597F95	383	600F04	365
564F115	381	585F387	342	586L19M028	362	597F95	384	600F05	363
564F128	381	585F397	341	586L19M028	367	597F96	383	600F05	365
564F345	381	585F407	342	586L19M028	368	597F96	384	600F06	363
564F378	381	585F705	360	586L19M032	362	597F97	383	600F06	365
564F408	381	585F705	382	586L19M032	367	597F97	384	600F07	363
564F438	381	585F715	360	586L19M032	368	598F20	361	600F07	365
564F688	381	585F715	382	586L19M036	362	598F21	361	600F08	363
564F888	381	585F72	382	586L19M036	367	598F22	361	600F08	365
564F898	381	585F729	361	586L19M036	368	598F59 Fin	362	600F09	363
564F908	381	585F76 Fin	362	586L19M040	362	598F592	364	600F09	365
564F918	381	585F762	363	586L19M040	367	598F592	366	600F10	363
564K52	340	585F762	365	586L19M040	368	598F809	364	600F10	365
564K53	340	585F77 Fin	362	586L19M044	362	598F815	364	600F11	363
564K59	340	585F772	363	586L19M044	367	598F815	366	600F11	365
564K60	340	585F772	365	586L19M044	368	598F825	364	600F12	363
566F50	375	585F78 Fin	362	586L19M048	362	598F825	366	600F12	365
566F51	375	585F79 Fin	362	586L19M048	367	598F835	364	600F13	363
569F45	354	585F792	365	586L19M048	368	598F835	366	600F13	365
574F158	344	585K24	340	596F618	367	598F905	364	600F14	363
574F258	368	585K25	340	596F618 Fin	362	598F905	366	600F14	365
574F268	368	585K26	340	596F628	367	599F275	364	600F415	360
574F29	368	585K27	340	596F628 Fin	362	599F275	366	600F415	382

Part Number	Page	Part Number	Page	Part Number	Page	Part Number	Page	Part Number	Page
600F425	360	604F248	367	613F142	369	628F107142	341	650F279	372
600F425	382	604F248 Fin	362	613F152	369	628F107171	341	650F279	381
600F62	363	604F258	367	613F162	369	628F107236	341	650F288	372
600F62	365	604F268	364	613F172	369	628F825	342	650F318	372
600F63	363	604F268	366	613F222	369	628F835	342	650F358	371
600F63	365	604F268	367	613F232	369	628F892	341	650F368	371
600F64	363	604F268 Fin	362	613F242	369	628F912	341	650F378	371
600F64	365	604F278	367	613F252	369	628F922 x Fin	341	650F388	371
600F65	363	604F278 Fin	362	613F352	369	628F932	342	650F398	371
600F65	365	604F288	367	613F422	369	628F962	341	650F408	371
600F66	363	604F288 Fin	362	613F432	369	628K852 x Fin	340	650F418	371
600F66	365	604F298	367	615F51	385	628K872 x Fin	340	650F428	371
600F67	363	605F42	348	615F51	384	628K882 x Fin	340	650F438	371
600F67	365	605F43	343	615F52	385	628K902 x Fin	340	650F448	371
600F68	363	605F768	370	615F52	384	628K952 x Fin	340	650F458	371
600F68	365	605F778	370	615F53	385	628K972 x Fin	340	650F468	371
600F69	363	605F90	369	615F53	384	628K992 x Fin	340	650F489	373
600F69	365	606F018	370	615F54	385	629F062 x Fin	341	650F498	373
600F70	363	606F028	370	615F54	384	629F072 x Fin	341	650F508	372
600F70	365	606F038	369	615F55	385	629K002 x Fin	340	650F518	372
600F71	363	606K73	340	615F55	384	629K012 x Fin	340	650F528	371
600F71	365	606K74	340	615F56	385	629K022 x Fin	340	650F538	372
600F72	365	606K75	340	615F56	384	629K032 x Fin	340	650F548	373
600F72	363	606K76	340	615F58	385	629K042 x Fin	340	650F558	373
600F73	363	606K77	340	615F58	384	630F482 x Fin	341	650F568	373
600F73	365	606K78	340	615F59	385	630F494	341	650F578	372
601F229	342	606K79	340	615F59	384	630K472 x Fin	340	650F588	371
601F24	361	607F919	342	615F60	385	631F248	360	650F598	371
601F25	361	609F36	343	615F60	384	631F248	363	650F60 fin	373
601F26	361	609F36	372	616F078	354	631F248	365	650F62	372
601F283 Fin*	362	609F37	343	616F088	354	649F99 fin	371	650F63	372
601F69	361	609F37	372	616F12	346	650F00	371	650F64	371
601F829	362	609F38	343	616F208	342	650F03	371	650F678LR	372
601F829	361	610F01	343	616F218	342	650F04	371	650F678RR	372
602F151	381	610F01	372	622F298	342	650F05	371	650F698LR	372
602F171	381	610F02	343	622F308	342	650F06	371	650F698RR	372
602F181	381	610F49	340	622F308	360	650F07	371	650F718	373
602F198	345	610K46	340	622F308	363	650F08	371	650F728	373
603F207	341	610K48	340	622F308	365	650F095	373	650F738	373
603F55	384	610L43	370	622F328	342	650F105	373	650F778	371
603F55	386	610L44	370	622F328	342	650F11	371	650F798	371
603F57	384	612K88	340	622F698	342	650F12	371	650F808	373
603F57	386	612K90	340	622F728	342	650F13	371	650F818	373
603F64	381	612K91	340	624F427	346	650F14	371	650F828	372
604F228	364	612K93	340	624F439	346	650F15	371	650F878	372
604F228	366	612K94	340	624F449	346	650F16	371	650F888	372
604F228	367	613F029	369	624F455	346	650F189	371	650F93	371
604F228 Fin	359	613F102	369	624F478	346	650F21	371	650F959	372
604F228 Fin	362	613F112	369	624F488	345	650F228	371	650F968	371
604F238	367	613F122	369	624F49	345	650F238	371	650F978	372
604F238 Fin	362	613F132	369	624F53	345	650F248	371	650F998	371

Part Number	Page	Part Number	Page	Part Number	Page	Part Number	Page	Part Number	Page
650L65	372	652F098	375	652F77	374	653F60	373	655F708	375
650L657020	372	652F108	375	652F77	374	653F60	374	655F718	372
651F00	374	652F118	375	652F78	373	653F61	373	656F408	372
651F01	374	652F128	375	652F79	373	653F61	374	656F41	372
651F04	374	652F138	375	652F79	374	653F61	374	656F44	373
651F06	374	652F148	375	652F80	373	653F62	373	656F45	373
651F08	374	652F158	375	652F80	374	653F62	374	656F46	373
651F09	374	652F218	375	652F80	374	653F63	373	656F47	373
651F10	374	652F228	375	652F81	373	653F63	374	656F48	373
651F362	375	652F239	375	652F82	373	653F65	373	656F49	373
651F372	375	652F298	372	652F82	374	653F65	374	656F50	373
651F389	375	652F57	373	652F83	373	653F66	373	656F51	373
651F398	375	652F58	373	652F83	374	653F66	374	656F52	373
651F408	375	652F58	374	652F83	374	653F68	373	656F53	373
651F418	375	652F59	373	652F84	373	653F68	374	656F58	374
651F425	375	652F59	374	652F85	373	653F69	373	656F59	374
651F448	375	652F59	374	652F86	373	653F69	374	656F60	374
651F478	375	652F60	373	652F87	373	653F70	373	656F61	374
651F498	375	652F61	373	652F88	373	653F70	374	656F62	374
651F508	375	652F61	374	652F89	373	653F70	374	656F63	374
651F538	375	652F62	373	652F90	373	653F71	373	656F64	375
651F545	375	652F62	374	652F92	373	653F71	374	656F658	375
651F568	375	652F62	374	652F93	373	653F72	373	656F668	372
651F578	375	652F63	373	652F95	373	653F72	374	670F30	353
651F587	375	652F64	373	652F96	373	653F73	373	670F31	353
651F608	375	652F64	374	652F99	373	653F73	374	670F32	353
651F618	375	652F65	373	653F02	373	653F73	374	670F33	353
651F628	375	652F65	374	653F03	373	653F74	373	670F34	353
651F638	375	652F65	374	653F04	373	653F74	374	670F35	353
651F648	375	652F66	373	653F05	373	653F75	373	670F36	353
651F655	375	652F67	373	653F08	373	653F75	374	670F37	353
651F675	375	652F67	374	653F09	373	653F76	373	670F38	353
651F708	375	652F68	373	653F10	373	653F76	374	670F57	353
651F738	375	652F68	374	653F12	371	653F76	374	670F58	353
651F758	375	652F68	374	653F13	371	653L157014	372	670F59	353
651F828	375	652F69	373	653F14	371	653L163016	372	670F60	353
651F838	375	652F70	373	653F50	373	653L163020	372	670F61	353
651F848	375	652F70	374	653F50	374	653L183016	372	670F62	353
651F858	375	652F71	373	653F53	373	653L183020	372	670F63	353
651F868	375	652F71	374	653F53	374	654F07	343	670F64	353
651F878	375	652F71	374	653F54	373	654F08	343	670F65	353
651F888	375	652F72	373	653F54	374	654F208	372	670F66	353
651F898	375	652F73	373	653F55	373	654F218	372	670F67	353
651F928	375	652F73	374	653F55	374	655F028	375	670F68	353
651F938	375	652F74	373	653F55	374	655F15	372	670F69	353
651F948	375	652F74	374	653F56	373	655F16	372	670F70	353
651F965	375	652F74	374	653F56	374	655F17	372	670F71	353
651F988	375	652F75	373	653F57	373	655F488LR	372	670F72	353
652F048	375	652F76	373	653F57	374	655F488RR	372	670F73	353
652F058	375	652F76	374	653F59	373	655F548	375	670F74	353
652F068	375	652F77	373	653F59	374	655F698	375	671F02	353

Part Number	Page	Part Number	Page	Part Number	Page	Part Number	Page	Part Number	Page
671F03	353	681F30	345	684F448	366	686F858	360	689F04	384
671F04	353	681F31	345	684F45 Fin	362	686F858	363	689F12	384
671F05	353	681F40	345	684F46 Fin	362	686F858	365	689F12	386
671F06	353	681F41	345	684F528	362	686F868	360	689F13	384
671F07	353	681F448	346	684F528	364	686F868	363	689F14	384
671F08	353	681F608	371	684F528	366	686F868	365	689F15	384
671F09	353	681F618	371	684F559	345	686F88 Fin	362	689F16	384
671F10	353	681F62	371	684F775	361	686F882	366	689F17	384
677F04	374	681F63	371	684F775	366	687F60	364	689F18	384
677F05	374	681F708	373	684F775	366	687F60	368	689F19	384
677F068	375	681F718	373	684F785	361	687F61	364	690F44	382
677F098	375	681F768	373	684F785	366	687F61	368	690F975	360
677F13	374	681F778	373	684F785	366	687F62	364	690F985	361
677F14	374	682F018	346	684F795	361	687F62	368	690F985	366
677F15	374	682F298	342	684F795	366	687F63	364	690F985	366
677F16	374	682F298	360	684F795	366	687F63	368	691F52	384
677F26	374	682F298	363	684F805	361	687F64	364	691F53	384
677F27	374	682F298	365	684F805	366	687F64	368	691F54	384
677F28	374	682F398	342	684F805	366	687F65	364	691F55	384
677F42	340	682F398	360	684F815	361	687F65	368	691F56	384
677F768LR 626	375	682F398	363	684F815	366	687F66	364	691F57	384
677F768RR 626	375	682F398	365	684F815	366	687F66	368	691F72	384
677F778LR 626	375	682F608	362	684F825	361	687F71	364	691F72	385
677F778RR 626	375	682F618	362	684F825	366	687F71	368	691F74	384
678F008LR	372	682F628	362	684F825	366	687F94	364	691F74	385
678F008RR	372	682F638	362	684F835	361	687F94	368	691F78	384
678F028	375	682F64 Fin	362	684F835	366	687F95	364	691F89	384
678F248	362	682F65 Fin	362	684F835	366	687F95	368	691F90	384
678F248	364	682F67 Fin	362	684F845	361	687F96	364	691F93	384
678F248	366	682F68 Fin	362	684F845	366	687F96	368	691F94	384
678F25	382	682F788	362	684F845	366	688F017	346	691F96	384
678F25 Fin	362	682F788	364	684F855	361	688F177	346	691F96	385
678F252	364	682F788	366	684F855	366	688F77	383	691F98	383
678F252	366	682F86 Fin	362	684F855	366	688F77	383	691F99	383
678F252 Fin	357	682F87 Fin	362	684F865	361	688F77	384	692F00	384
678F498	362	682F91	382	684F865	366	688F77	385	692F01	384
678F498	366	682F918	342	684F865	366	688F95	383	692F02	383
678F548	345	682F958	360	684F875	366	688F95	383	692F02	384
678F677	345	682F958	363	684F875	366	688F95	384	692F03	383
679F818	359	682F958	365	684F885	361	688F95	385	692F03	384
679F818	362	682F969	360	684F885	366	689F01	383	692F04	384
679F818	364	682F969	363	684F885	366	689F01	385	692F04	385
679F818	369	682F969	365	685F098	342	689F01	384	692F05	384
679F818	361	684F055	346	685F387	346	689F02	383	692F05	385
680F348	355	684F068	346	685F505	382	689F02	385	692F14	386
680F358	355	684F119	346	685F515	382	689F02	384	692F15	386
680F368	355	684F129	346	685F525	382	689F03	383	692F16	386
680F645	342	684F42	372	685F535	382	689F03	385	692F17	386
680L50	366	684F427	372	685F545	382	689F03	384	692F19	386
680L51	366	684F44 Fin	362	685F555	382	689F04	383	692F20	386
680L52	366	684F448	364	685F875	361	689F04	385	692F21	386

Part Number	Page	Part Number	Page	Part Number	Page	Part Number	Page	Part Number	Page
692F23	386	695F247265 - .265"	341	697F338	372	701F61	372	712F205	360
692F24	386	695F247281 - .281"	341	697F348	372	701F62	372	712F215	360
692F25	386	695F252031 - .031"	341	697F358	372	701F63	372	712F225	360
692F632	356	695F252047 - .047"	341	697F368	372	701F705	346	712F235	360
692F642	356	695F252063 - .063"	341	697F50	342	701F748	345	712F265	360
692F652	356	695F252078 - .078"	341	697F507	341	702F987	345	712F275	360
692F662	356	695F252094 - .094"	341	697F862	371	703F997	346	712F325	361
692F672	356	695F252110 - .110"	341	697F942	360	704F269	371	712F335	361
692F752	356	695F252126 - .126"	341	697F942	363	704F279	371	712F345	361
692F762	356	695F252141 - .141"	341	697F942	365	704F479	371	712F355	361
692F862	356	695F252157 - .157"	341	697F988	381	704F489	371	712F365	361
692F932	356	695F252173 - .173"	341	697F995	361	704F569	371	712F375	361
692F942	356	695F252189 - .189"	341	698F038	371	704F579	371	712F385	360
692F952	356	695F252204 - .204"	341	698F22	354	704F589	371	712F395	360
693F208	370	695F252220 - .220"	341	698F22	354	704F599	371	712F405	360
694F312	356	695F252236 - .236"	341	698F43	382	704F62	372	712F415	360
694F322	356	695F252252 - .252"	341	698F44	382	704F63	372	712F425	360
694F332	356	695F252267 - .267"	341	698F45	382	704F648	372	712F435	360
694F352	356	695F252283 - .283"	341	698F46	382	704F658	372	712F455	361
694F392	356	695F252299 - .299"	341	698F51	382	704F66	372	712F465	361
694F442	356	695F257031 - .031"	341	698F52	382	705F949	345	712F475	361
694F482	356	695F257047 - .047"	341	698F53	382	706F005	375	712F485	361
694F522	356	695F257063 - .063"	341	700F168	355	706F015	375	712F495	361
694F562	356	695F257078 - .078"	341	700F278	345	706F038	371	712F505	360
694F602	356	695F257094 - .094"	341	700F367	355	706F048	371	712F515	360
694F682	356	695F257110 - .110"	341	700F378	355	706F058	371	712F525	360
694F722	356	695F257126 - .126"	341	700F40	351	706F068	371	712F535	360
694F802	356	695F257141 - .141"	341	700F41	351	706F078	371	712F545	360
695F042 x Fin	341	695F257157 - .157"	341	700F42	351	706F088	371	712F555	360
695F052 x Fin	341	695F257173 - .173"	341	700F43	351	706F098	371	712F565	360
695F075	360	695F257189 - .189"	341	700F44	351	706F108	371	712F575	360
695F22	381	695F257204 - .204"	341	700F45	351	706F15	371	712F605	361
695F23	381	695F257220 - .220"	341	700F46	351	706F16	371	712F615	361
695F244139 - .139"	341	695F257236 - .236"	341	700F47	351	706F462	372	712F625	361
695F244155 - .155"	341	695F257252 - .252"	341	700F575	342	706F70	355	712F635	361
695F244171 - .171"	341	695F257267 - .267"	341	700F65	355	707F57	355	712F645	361
695F244187 - .187"	341	695F257283 - .283"	341	700F66	355	707F58	355	712F655	361
695F244202 - .202"	341	695F257299 - .299"	341	700F67	355	707F59	355	712F665	361
695F244218 - .218"	341	696F05	382	700F708	346	707F60	355	712F675	361
695F244234 - .234"	341	696F318	381	700F748	346	710F00M	372	712F685	360
695F244250 - .250"	341	696F39	355	700F80	351	710F318LR	372	712F695	360
695F244265 - .265"	341	696F42	342	700F81	351	710F318RR	372	712F705	360
695F244281 - .281"	341	696F472	341	700F82	351	710F328LR	372	712F715	360
695F247139 - .139"	341	696F499	341	700F83	351	710F328RR	372	712F725	360
695F247155 - .155"	341	696F502 x Fin	341	700F84	351	710F338LR	372	712F735	360
695F247171 - .171"	341	696F51	342	700F86	351	710F338RR	372	712F745	361
695F247187 - .187"	341	696K43	340	700F87	351	710F618	362	712F755	361
695F247202 - .202"	341	696K45	340	700F907	345	710F628	362	712F765	361
695F247218 - .218"	341	696K46	340	700F957	346	710F658	362	712F775	361
695F247234 - .234"	341	696K48	340	701F228	345	710F668	362	712F785	361
695F247250 - .250"	341	696K52	340	701F60	372	711F002	355	712F795	361

Part Number	Page	Part Number	Page	Part Number	Page	Part Number	Page	Part Number	Page
713F518	372	721F16	355	754F13	385	756F527	342	775F918 Fin	359
713F528	372	721F17	355	754F14	384	756F527	342	775F948	358
713F908	372	721F18	355	754F14	385	756F537	342	776F002 Fin	358
713F938	372	721F19	355	754F15	384	756F537	342	776F012 Fin	358
713F948	372	723F26	355	754F15	385	756F542	342	776F022 Fin	358
713F958	372	723F69	355	754F16	384	756F542	342	776F032 Fin	358
713F988	372	728F709	386	754F16	384	756F557	342	776F042 Fin	358
713F998	372	728F759	386	754F16	385	756F557	342	776F215	357
714F005	360	728F799	386	754F20	385	756F567	342	776F225	357
714F035	360	728F799	386	754F21	385	756F567	342	776F235	357
714F065	360	728F809	386	754F24	385	756F582	342	776F245	357
714F125	360	728F939	386	754F25	385	756F582	342	776F335	357
714F155	361	730F778	372	754F26	385	756F582	342	776F345	357
714F185	361	733F05	374	754F29	385	756F622	342	776F395	357
714F215	361	733F41	374	754F34	385	756F622	342	776F405	357
714F255	360	733F42	374	754F35	385	756F963	370	776F415	357
714F275	361	733F43	374	754F37	385	763F002243	341	776F425	357
714F305	360	733F44	374	754F43	384	763F002273	341	776F515	357
714F315	360	733F45	374	754F44	384	763F002303	341	776F525	357
714F365	360	733F46	374	754F45	384	763F002333	341	776F575	357
714F375	360	733F47	374	754F52	386	763F002363	341	776F585	357
714F425	360	733F48	374	754F53	386	763F002393	341	776F638	358
714F455	360	733F49	374	754F54	386	763F012030	341	776F648	358
714F485	361	733F50	374	754F55	386	763F012060	341	776F658	358
714F495	361	733F51	374	754F56	386	763F012090	341	776F668	358
714F545	361	733F52	374	754F57	386	763F012120	341	776F678	358
714F555	361	733F53	374	754F58	386	763F012150	341	776F688	358
714F605	361	741F21	355	754F59	386	763F012180	341	776F698	358
714F635	361	741F22	355	754F61	386	763F012210	341	776F708	358
715F108	342	741F23	355	754F62	386	763F012240	341	776F718	358
715F118	342	741F24	355	754F63	386	763F012270	341	776F728	358
715F128	342	744F208	372	754F64	386	763F012300	341	776F738	358
715F152	341	744F258	372	754F66	386	763F012330	341	776F748	358
715F245	360	744F688	372	754F68	383	763F027120	341	776F758	358
715F892	342	751F16	350	754F69	383	763F027150	341	776F768	358
715K14	340	751F17	350	754F70	383	763F027180	341	776F778	358
716K16	340	753F078	346	754F71	386	763F027210	341	776F788	358
716K43	340	753F098	345	754F72	386	763F027240	341	776F798	358
716K45	340	753F598	359	754F73	386	763F027270	341	776F808	358
716K46	340	753F697	345	754F79	383	763F072	341	776F818	358
716K48	340	754F02	386	754F80	383	774F225	357	776F828	358
720F21	355	754F03	386	754F92	383	774F878	358	776F838	358
720F22	355	754F04	386	754F93	383	774F888	358	776F848	358
720F24	355	754F05	386	754F94	383	774F945	357	776F858	358
720F25	355	754F09	384	754F95	383	774F965	357	776F868	358
720F43	345	754F09	385	754F96	383	774F985	357	776F878	358
720F46	345	754F10	384	754F98	383	775F808	358	776F918	358
720F61	355	754F10	385	756F507	342	775F818	358	776F928	358
720F62	355	754F12	384	756F507	342	775F828	358	776F938	358
720F64	355	754F12	385	756F517	342	775F838	358	776F948	358
720F65	355	754F13	384	756F517	342	775F908 Fin	359	776F958	358

Part Number	Page	Part Number	Page	Part Number	Page	Part Number	Page	Part Number	Page
776F968	358	779F345	357	780F90 Fin	358	789F929	386	796F358	363
776F978	358	779F395	357	780F91 Fin	358	790F047	346	796F368	363
776F988	358	779F405	357	780F92 Fin	358	790F208	359	796F378	363
776F998	358	779F415	357	780F93 Fin	358	790F215	357	796F378	365
777F208	358	779F425	357	780F94 Fin	358	790F225	357	796F388	363
777F215	357	779F515	357	780F95 Fin	358	790F225	357	796F398	363
777F225	357	779F525	357	780F96 Fin	358	790F235	357	796F398	363
777F235	357	779F575	357	783F048	375	790F245	357	796F398	365
777F245	357	779F585	357	783F06	374	790F245	357	796F408	363
777F335	357	779F638	358	783F208	360	790F335	357	796F408	365
777F345	357	779F648	358	783F308	360	790F345	357	796F43	370
777F395	357	779F658	358	783F408	360	790F395	357	796F46 x Fin	370
777F405	357	779F728	358	785F008	360	790F405	357	797F618	365
777F415	357	779F738	358	785F018 Fin	360	790F415	357	797F628	365
777F425	357	779F748	358	785F028 Fin	360	790F425	357	797F638	365
777F515	357	779F758	358	785F038	360	790F515	357	797F648	365
777F525	357	779F787	359	785F048	360	790F525	357	797F658	365
777F575	357	779F797	359	785F058	360	790F575	357	797F668	365
777F585	357	779F807	359	785F068	360	790F585	357	797F678	365
778F215	357	779F97 Fin	357	785F078 Fin	360	790F988	359	797F688	365
778F225	357	779F98 Fin	357	785F088	360	790F988	359	797F698	365
778F225	357	779F99 Fin	357	785F088	360	790F998	359	797F708	365
778F235	357	780F208	359	785F108	360	790F998	359	797F718	365
778F245	357	780F215	357	785F118 Fin	360	791F51 x Fin	370	797F728	365
778F245	357	780F225	357	785F138 Fin	360	791F59	355	797F738	365
778F335	357	780F235	357	785F148	360	791F60	355	797F748	365
778F345	357	780F245	357	785F158 Fin	360	791F82 Fin	370	797F758	365
778F395	357	780F335	357	785F168	360	791F83 Fin	370	797F768	365
778F405	357	780F345	357	785F178	360	791F84 Fin	370	797F778	365
778F415	357	780F395	357	785F188	360	791F85 Fin	370	797F788	365
778F425	357	780F405	357	785F198	360	791F86 Fin	370	797F808	365
778F515	357	780F415	357	785F218 Fin	360	791F87 Fin	370	797F818	366
778F525	357	780F425	357	785F228	360	792F997	341	797F828	364
778F575	357	780F515	357	785F238	360	794F509	386	797F828	366
778F585	357	780F525	357	785F248	360	794F519	386	797F838	366
778F638	359	780F575	357	785F258	360	794F529	386	797F845	364
778F759	359	780F585	357	785F268 Fin	360	794F539	386	797F845	366
778F788	358	780F638	359	785F278	360	754F97	383	797F855	364
778F812	359	780F648	358	785F288	360	796F118	364	797F855	366
778F868	359	780F658	358	785F298	360	796F118	366	797F865	364
778F888	358	780F662	358	785F308	360	796F208	363	797F865	366
778F898	358	780F808	358	785F318 Fin	360	796F218	363	797F875	364
778F90 Fin	357	780F81 Fin	358	785F328	360	796F228	363	797F875	366
778F91 Fin	359	780F82 Fin	358	785F338	360	796F238	363	797F915	364
778F968	359	780F83 Fin	358	785F348	360	796F248	363	797F915	366
778F97 Fin	357	780F84 Fin	358	785F358	360	796F258	363	797F925	364
779F215	357	780F85 Fin	358	785F378 Fin	360	796F268	363	797F925	366
779F225	357	780F86 Fin	358	785F388 Fin	360	796F30 x Fin	370	797F935	364
779F235	357	780F87 Fin	358	789F859	386	796F318	363	797F935	366
779F245	357	780F88 Fin	358	789F869	386	796F328	363	797F945	364
779F335	357	780F89 Fin	358	789F879	386	796F338	363	797F945	366

Part Number	Page	Part Number	Page	Part Number	Page	Part Number	Page	Part Number	Page
798F115	364	799F635	361	855F658	352				
798F115	366	799F645	361	856F049	352				
798F125	364	799F665	361	858F241	352				
798F125	366	799F675	361	858F251	352				
798F135	364	799F685	361	858F261	352				
798F135	366	799F695	361	858F271	352				
798F145	364	799F805	360	858F281	352				
798F145	366	799F815	360	858F291	352				
798F155	364	799F825	360	858F549	352				
798F155	366	799F835	360	858F497 x Finish	352				
798F165	364	799F845	361	858F517 x Finish	352				
798F165	366	799F855	361	858F50M FIN	352				
798F175	364	799F865	361	858F52M FIN	352				
798F175	366	799F875	361	858F53M FIN	352				
798F185	364	813F505	346	858F55M FIN	352				
798F185	366	820F008	345	Ø 236L718018	380				
798F215	366	820F048	346	Ø 399F168	380				
798F215	366	820F068	346	Ø 405F466	380				
798F225	366	820F078	346	Ø 409F836	380				
798F225	366	820F088	346						
798F235	366	820F148	345						
798F235	366	820F168	346						
798F245	366	820F268	345						
798F245	366	820F278	345						
798F255	366	820F348	345						
798F255	366	820F358	345						
798F265	366	852F307	346						
798F265	366	852F318	346						
798F275	366	853F05	354						
798F275	366	853F865	346						
798F285	366	853F875	346						
798F285	366	854F00	352						
798F295	357	854F01	352						
798F305	357	854F03	352						
798F395	357	854F04	352						
798F405	357	854F05	352						
798K912 x Fin	340	854F06	352						
798K922 x Fin	340	854F08	352						
799F505	360	854F09	352						
799F515	360	854F11	348						
799F525	360	854F15	348						
799F535	360	854F19	348						
799F545	360	854F23	348						
799F555	360	854F27	348						
799F565	360	855F619	352						
799F575	360	855F707	352						
799F585	360	855F727	352						
799F595	360	855F747 x Finish	352						
799F605	361	855F767 x Finish	352						
799F615	361	855F638	352						
799F625	361	855F649	352						



ASSA ABLOY

Notes

USA & Canada Prices Effective March 16, 2020

For more information regarding Corbin Russwin Locksets, Exit Devices, Door Controls and Key Systems, contact your authorized Corbin Russwin Distributor or Sales Representative.

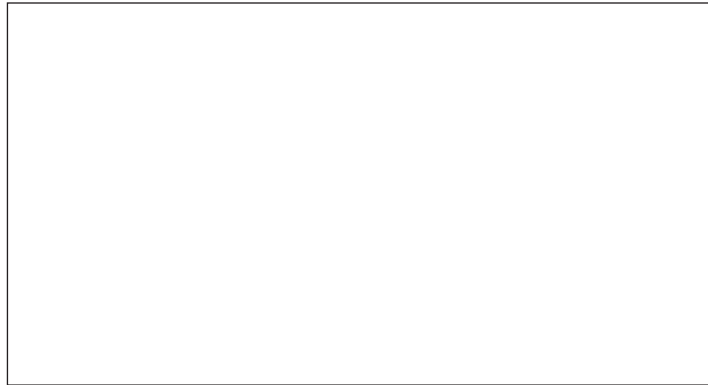

Corbin Russwin Architectural Hardware

225 Episcopal Road
Berlin, CT 06037
Phone 800-543-3658
Fax 800-447-6714
www.corbinrusswin.com

Notice: This price book takes precedence over the catalog as to the correctness and availability of items in our entire line.

Corbin Russwin and Design®, Corbin®, Russwin®, and Design® Access 800®, Muséo®, and SecureBolt® are registered trademarks of Corbin Russwin, Inc., an ASSA ABLOY Group company. Safeguard™, PathLite™ and Vineyard™ are trademarks of Corbin Russwin, Inc., an ASSA ABLOY Group company. Unitrol® is a registered trademark of Yale Security Inc., an ASSA ABLOY Group company. These materials are protected under US copyright laws. All contents current at time of publication. Corbin Russwin Inc., an ASSA ABLOY Group company reserves the right to change availability of any item in this catalog, its design, construction, and/or its materials. Other products' brand names may be trademarks or registered trademarks of their respective owners and are mentioned for reference purposes only.

Copyright © 2002-2020 Corbin Russwin, Inc., an ASSA ABLOY Group company. All rights reserved. Reproduction in whole or in part without the express written permission of Corbin Russwin, Inc. is prohibited.