

LCN®

Automatic
operators





Improving accessibility through superior door control

Since 1877, LCN has been a leader in delivering safety and security through superior door control. Building on our pioneering past, LCN continues investing in innovations to ensure superior performance and expertise at every point of the customer journey.

Manufactured with pride in Princeton, Ill., U.S.A., by our highly skilled and tenured craftsmen. Our solutions are specifically designed for enhanced durability, consistency and longevity. From meticulous engineering to strict quality control, LCN accepts no less than the best. We require review and approval of supplier materials, adhere to in-house testing, and assemble a customized solution for your application's needs. Our quality control focuses on producing products that conform to industry standards and exceed customer expectations.

LCN automatic operators have been improving accessibility in schools and health care facilities for over 20 years. Provided at a reliable factory setting, LCN operators allow for field adjustability to tailor performance to individual needs. Our Sales and Technical Services teams provide support throughout every step of our process, whether consulting on code, advising a door specification or answering installation questions. We are focused on making your LCN experience positive.

Automatic operator features

- Easily retrofitted into existing doors and frames, as well as new construction
- Breadth of offerings are certified to ANSI156.19 and meet ADA requirements
- Electrohydraulic offerings are best for primarily manual applications; they feature a heavy duty closer to handle closing function and electronics to perform automatic opening
- Electromechanical offerings are best for primarily automatic operations; they include a motor gearbox and controller that perform the opening and closing function
- All operators allow for smooth manual operation and reliable automatic operation for a variety of pedestrian and accessibility needs and preferences
- LCN provides replacement parts for purchase in order to ensure continued performance and extended life of the product



Information and customer care



us.allegion.com



US 877.671.7011
Canada 800.900.4734



support@allegion.com
Closers_TechProdSupport@allegion.com



www.youtube.com/LCNHardware

Ordering



Allegion_Orders@allegion.com



eFax: 1.800.248.1460

Automatic operators

Product selection guide

LCN automatic operators have been improving accessibility in schools and health care facilities for over 20 years. All automatic operator systems are easily retrofitted into existing doors and frames, as well as new construction. Low energy electrohydraulic and pneumatic automatic operators feature a heavy duty closer with a slow opening function. Electromechanical automatic operators utilize a motor gearbox and control box to perform the opening and closing function.

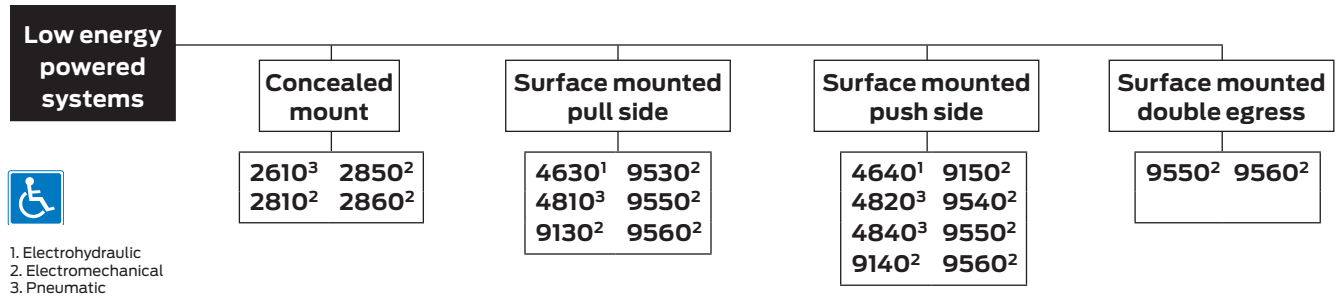

Electrohydraulic/pneumatic product comparison

This chart shows a basic features comparison of the LCN electrohydraulic and pneumatic automatic operator systems designed to provide easy access without sacrificing closing power. Refer to the specific closer chapter for complete details.

	Mounting				Finish		Cover			Cylinder		Arm function*							
	Top jamb (pull) side	Top jamb (push) side	Parallel arm	Concealed	Powder coat	Plated	Plastic	Metal	Non-handed	Non-sized	Accessibility	Automatic operator	Hold open	DPS	Standard (single)	Regular (double)	EDA	CUSH	SCUSH
2610	■	■	■	■	■	■	■	■	■	■	■	■	■	90°	■	■	■	■	
4630	■	■	■	■	■	■	■	■	■	■	■	■	■	90°	■	■	■	■	
4630CS	■	■	■	■	■	■	■	■	■	■	■	■	■	90°	■	■	■	■	
4640	■	■	■	■	■	■	■	■	■	■	■	■	■	90°	■	■	■	■	
4640CS	■	■	■	■	■	■	■	■	■	■	■	■	■	90°	■	■	■	■	
4810	■	■	■	■	■	■	■	■	■	■	■	■	■	90°	■	■	■	■	
4820	■	■	■	■	■	■	■	■	■	■	■	■	■	90°	■	■	■	■	
4840	■	■	■	■	■	■	■	■	■	■	■	■	■	90°	90°	90°	90°	90°	

■ Available
■ Not available

♿ Meets ADA requirements (power mode).
* See individual series for maximum manual opening.
** Switch provided for continuous Hold Open (4630 and 4640 only).

Electromechanical product comparison

This chart shows a basic features comparison of the LCN electromechanical automatic operator systems designed to provide easy access without sacrificing closing power. Refer to the specific operator chapter for complete details.

	Mounting			Handing		Finish		Cover		Arm function					
	Surface mount, single door	Surface mount, simultaneous pair	Surface mount, independent pair	Concealed single door	Concealed simultaneous pair	Concealed independent pair	Handed*	Non-handed	Standard anodized	Metal	Standard (single lever)	Regular (double lever)	Double egress (push/pull)	Offset pivot arm	Center pivot arm
2810	■	■	■	■	■	■	■	■	■	■	■	■	■	■	
2850	■	■	■	■	■	■	■	■	■	■	■	■	■	■	
2860	■	■	■	■	■	■	■	■	■	■	■	■	■	■	
9130	■	■	■	■	■	■	■	■	■	■	■	■	■	■	
9140	■	■	■	■	■	■	■	■	■	■	■	■	■	■	
9150	■	■	■	■	■	■	■	■	■	■	■	■	■	■	
9530	■	■	■	■	■	■	■	■	■	■	■	■	■	■	
9540	■	■	■	■	■	■	■	■	■	■	■	■	■	■	
9550	■	■	■	■	■	■	■	■	■	■	■	■	■	■	
9560	■	■	■	■	■	■	■	■	■	■	■	■	■	■	

■ Available
■ Not available

* Handed for 2850 and 2860, double egress only.

Introduction
 Product selection guide
 Pneumatic systems
 Auto equalizers
 2610/4810/4820/4840/7900 Series
 Electrohydraulic systems
 Auto equalizers
 4630/4640 Series
 Electromechanical systems
 Benchmark
 9130/9140/9150 Series
 Electromechanical systems
 Senior Swing
 2810/2850/2860/9530/9540/9550/9560 Series
 Actuators and accessories

What is the ADA

The ADA is a civil rights law, not a building code. This act is designed to provide protection for people with disabilities. The law is divided into four major titles that prohibit discrimination against the disabled in Employment, Title I, Public Services and Transportation Title II, Public Accommodations Title III, and Telecommunications Title IV. Title III concerns doors and door controls.

The intent of ADA, Title III

Essentially, businesses of all types must comply with accessible design standards to provide people with disabilities with access equal to, or similar to, that available to the general public. Businesses that serve the public must also remove barriers to existing facilities where readily achievable. The deadline for compliance was January 26, 1992.

The final rules implementing Title III were published in the Federal Register of July 26, 1991. To obtain a copy or ask questions, contact the U.S. Department of Justice. Technical information can be obtained from The U.S. Architectural and Transportation Barriers Compliance Board.

How ADA affects doors

The ADA requires an “accessible” opening which means, among other things, providing a door with a minimum 32" (813 mm) clear width opening, easily manipulated handles, a maximum opening force, a minimum closing time, and the capability to open to at least 90°.

ADA criteria, based on opening force, are similar to American National Standards Institute (ANSI) Standard A117.1. This is different from ANSI Standard A156.4, which is based on closing force. What are the opening force limits?

Door type	Opening force
Fire rated	Note 1
Interior non-fire-rated	5.0 lbs. (22.2 N)
Exterior non-fire-rated	“Reserved”

1. All fire rated doors should have the minimum opening force allowable by the appropriate administrative authority, typically the local Fire Marshal. Closing and latching a fire door takes precedence over ADA opening force limits.

How the door is measured

Two ADA criteria affect the door closer selection, adjustments, opening force, and time to close. Since the law does not clearly define the method of measurement, this is LCN’s recommendation.

1. On the push side of the door, locate a point at the center line of the push plate/lock trim or 34" (864 mm), from the hinge edge of the door, whichever is greater.
2. Mark the floor at a point where the push side of the doors’ latch stile is at 70°. Mark a second point where the push side is 3" (76 mm) from the latch.

3. Open the door so the latch is clear of the strike and the door is slightly off the stop.
4. Using a force gauge on the mark determined in Step #1, push the door open to the 70° mark established in Step #2. Observe the force readings. (Accuracy of the readings varies with the gauge quality.)
5. Adjust the closer spring power to meet the maximum opening force.
6. Hold the door at the 70° mark. Release the door and time the closing sweep between the two marks.
7. Adjust the closer main speed regulation valve to obtain a minimum 3 second “time to close”.

Finishes

- Available in six standard or a wide selection of optional custom powder coat finishes to blend with door and frame
- LCN’s powder coat finishes surpass 100 hours of salt spray which is over four times the ANSI standard for corrosion resistance
- For installations where a higher level of corrosive resistance is required, LCN offers an optional Special Rust Inhibitor (SRI) pretreatment
- Closers that combine the exclusive LCN powder coat finish and the SRI pre-treatment exceed the ANSI standard for corrosion resistance even further
- Plated finishes are available as an option to accent door and frame

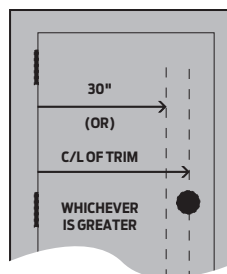
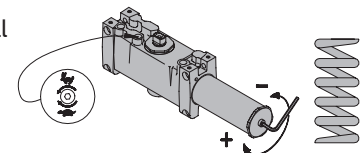

NOTE: Delay Action closers are not necessary to meet the ADA 3 second “time to close” requirement but do offer additional time for people to pass through the door.

Caution!

Any manual door closer, including those certified by BHMA to conform to ANSI Standard 156.4, that is selected, installed, and adjusted based

on ADA requirements may not provide sufficient power to reliably close and latch a door. Auto Equalizer systems offer an alternate solution.

Choices for ADA compliant door controls

LCN offers both surface and concealed mountings for powered systems or manual closers.

Powered systems

LCN Automatic Operator Systems offer easy access for the disabled and resolve the problem of obtaining reduced opening force while providing adequate closing force.

How the door is measured

Manual closers rely on reduced spring power to meet opening force requirements. Automatic operators provide solutions to overcome challenges that may arise with a mechanical closer regarding opening and closing force. Four principle factors affect the performance of closers:

1. **Door width:**
A wider door provides more leverage for the user, thus reducing the opening force required.
2. **Spring power:**
Adjusting spring power to achieve a lower opening force also reduces the closing force available.
3. **Arm selection:**
The superior mechanical advantage of a regular arm system offers the user significantly lower average opening forces through the 70° measurement range compared to a Standard Arm (track type) closer. Regular Arms also provide superior latching power.

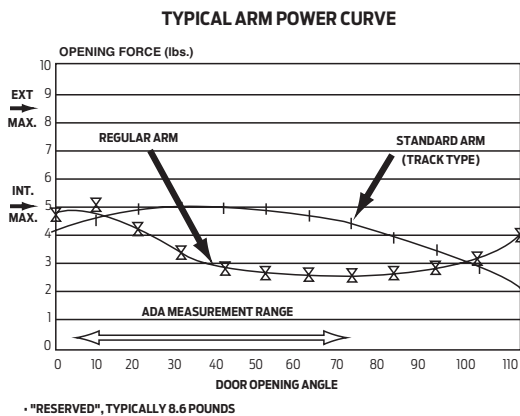
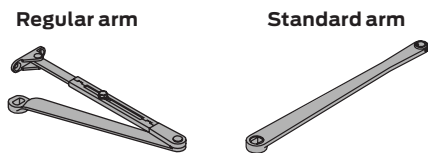

4. **Additional forces:**
Improperly hung doors, stiff latches, HVAC or environmental pressures, and other forces acting on the door require increasing the closer spring power to reliably close and latch a door which produces a corresponding increase in opening force.

Information sources

LCN Closers Phone: 877-671-7011
 121 W Railroad Ave. Fax: 800-248-1460
 P.O. Box 100
 Princeton, IL, USA 61356-0100
<https://us.allegion.com/en/home/products/brands/lcn.htm>

U.S. Department of Justice
 The Office of the Americans with Disabilities Act, Civil Rights Div.,
 P.O. Box 66118, Washington, D.C. 20035-6118
 Phone: 202-514-0301

The U.S. Architectural and Transportation Barriers Compliance Board
 1111 18th Street N.W., Suite 501,
 Washington, D.C. 20036
 Phone: 800-872-2253

American National Standards Institute
 11 West 42nd Street, New York, N.Y. 10036
 Phone: 212-642-4900

- ANSI A117.1 Providing Accessibility and Usability for Physically Handicapped People
- ANSI A156.4 for Door Controls - Closers
- ANSI A156.19 Power Assist and Low Energy Power Operated Doors

Electrohydraulic and pneumatic fasteners
 Standard Wood and Machine Screws (WMS) pack contains Phillips head wood and machine screws to install the closer. Through Bolts (TB) and/or Torx machine screws are available for all closers, except the 2610 series. LCN through bolts can be installed on 1 3/4" thick doors with either the 1/4"-20 machine screws or optional Torx security screws supplied with the closer. Optional sizes are available for 1 5/8" or 1 3/8" door thicknesses, but must be specified when ordering.

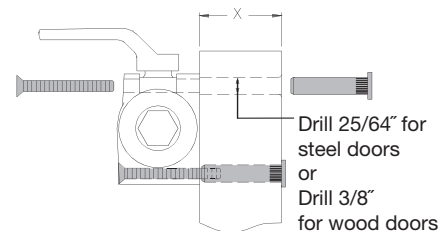

Electromechanical fasteners
 Typically installed 1/4"-20 machine screw for aluminum/steel frames. Wood screws included for wood door mounting. Consult factory for additional information.

Introduction
 Product selection guide
 Pneumatic systems Auto equalizers 2610/4810/4820/4840/7900 Series
 Electrohydraulic systems Auto equalizers 4630/4640 Series
 Electromechanical systems Benchmark 9130/9140/9150 Series
 Electromechanical systems Senior Swing 2810/2850/2860/9530/9540/9550/9560 Series
 Actuators and accessories

Low energy operators

The basic design concept for all LCN automatic operator systems considers both the opening and closing motion of the door. Our designs allow the system to be easily retrofitted into existing doors and frames as well as new construction. A basic LCN electrohydraulic/pneumatic system consists of an automatic operator that incorporates a heavy duty LCN 4040XP Series door closer and peripheral actuators. Our electromechanical automatic operators utilize a motor gearbox and a control box to perform the opening and closing function. LCN offerings include electrohydraulic, electromechanical and pneumatic low energy automatic operators.

Applications

- Electrohydraulic and pneumatic systems are used primarily for manual opening with available push button automatic opening
- Electromechanical systems are used primarily for automatic openings
- Dedicated handicap access
- Stand alone or larger multi-door systems
- Surface and concealed mountings
- Installation accessories available for non-standard conditions
- CAUTION! For exterior doors exceeding 3' 0" wide by 7' 0" tall, interior doors exceeding 4' 0" wide by 8' 0" tall, or any door exceeding 225 pounds, consult factory before specifying or installing LCN electrohydraulic or pneumatic automatic operators
- CAUTION! For exterior doors exceeding 4' 0" wide by 7' 0" tall, interior doors exceeding 4' 0" wide by 8' 0" tall, or any door exceeding 400 pounds, consult factory before specifying or installing LCN Senior Swing
- CAUTION! For exterior doors exceeding 4' 0" wide by 7' 0" tall, interior doors exceeding 4' 0" wide by 8' 0" tall, or any door exceeding 200 pounds, consult factory before specifying or installing LCN Benchmark

A156.19 System Design Parameters

- Cycle test standard of 300,000 full load operating cycles.
- Power opening plus full door control.
- Open to back check no faster than 3 seconds.
- Opening time to fully open is no faster than 4 seconds.
- Remain fully open for at least 5 seconds.
- Closing time from 90° to 10° is no faster than 3 seconds.
- Less than 15 lb to stop doors motion.
- Kinetic energy must not exceed 1.25 lb-ft.
- In event of failure, less than 15 lb to release latch, less than 30 lb to put door in motion, less than 15 lb to fully open door system

Common system features

- Power opening plus full door control.
- No guide rails or safety devices required due to low energy design
- Adjustable opening force
- Adjustable closing power
- All LCN operators are ADA compliant with actuated opening
- Electrohydraulic and pneumatic systems feature adjustable back check that slows opening swing at about 70°
- Electromechanical systems feature electronic back check that slows opening swing at about 70°
- Systems allow for separate adjustment of general closing and latch speed
- Electrohydraulic and pneumatic systems are available in six standard finishes or a wide selection of optional custom powder coat finishes to blend with door and frame.
- Electromechanical systems are available in two standard anodized finishes
- UL and NEC compliant
- Compatible with most security and safety systems
- Capable of full integration with high security keypads and card readers
- Wiring allows for sequential operation for vestibule applications.
- Electromechanical systems require additional components.
- Modular design simplifies installation and maintenance

Warranty

2 year limited warranty. See General Information catalog for complete details.

Maintenance

- For best performance, mount operators according to the LCN installation instructions
- Periodic visual inspections are recommended

Pneumatic powered systems

LCN Pneumatic Auto Equalizer systems use the power of pressurized air to do the work of automatically opening the door. A basic pneumatic system consists of an automatic operator to provide the door control, a control box that contains the valves and electrical timing circuits, actuators to start the system, and a compressed air source.

Multi-door and single-door solutions

A single control box may power up to two pairs of doors simultaneously making pneumatic automatic operators a cost-effective solution for single or multi-door applications. This flexibility results in significant savings in material and installation costs.

Quiet operation

Since the pneumatic automatic operators are powered by pressurized air, they are quiet, efficient, and very reliable. Flexible LCN pneumatic tubing is the only connection between the control box and the door frame. There is no need for high-voltage wiring at the door frame since all of the power for operation is generated by pressurized air located away from the door frame. (Note: special fittings are available so $\frac{3}{16}$ " metal tubing (by others) can be used in fire rated plenums).

Standards, listings and approvals

- Meets ADA opening force requirements
- Consult the factory for other listings

Pneumatically (air) powered

All pneumatic automatic operators require a compressed air source. LCN's pneumatic systems have the flexibility to run as an independent unit (7980 Series has a compressor built into the control box) or to run off an existing air supply (7900 Series has connections for utilizing existing air supply).

Using a self-contained 7980 Series control box for single or double door leaf applications eliminates the need for an independent compressor. Existing building air compressors with a storage tank can be used to reduce the cost of multi-door systems and must utilize the 7900 Series control boxes.

Easy adjustment/installation

The air pressure and timing cycle are easily adjustable to meet the need of a specific installation. Because the control box can be located anywhere within 100 linear tubing feet from the controlled door for the 7900 Series or within 50 linear tubing feet for the 7980 Series, they can be placed in easily accessible locations. Convenient features such as sequential operation of vestibule doors are available.

Multiple mounting configurations

Available in three different mounting configurations:

- Concealed in the frame (2610 Series)
- Top jamb surface mounted on the pull side of the door (4810 Series)
- Top jamb surface mounted on the push side of the door (4820 Series)
- Door mounted, parallel arm on the push side of the door (4840 Series)

Hazardous location use

Since there is no high-voltage wiring at the door frame, pneumatically powered systems are ideal for use in hazardous areas. The control box, which contain the valves and electrical timing circuits, is remotely located.

Blow-open (smoke evacuations systems)

An auxiliary "blow-open" box is available and is controlled by the building smoke evacuation system. When activated, the normal pneumatic automatic operator functions are not available. The 7949 Series "blow-open" box works with or without the 7900 Series control boxes. (Limited to 50 linear foot of tubing).

Warranty

2 year limited warranty. See General Information catalog for complete details.

Maintenance

- For best performance, mount operators according to the LCN installation instructions
- Periodic visual inspections are recommended
- Inspect and service filter assembly in 7900 Series control boxes as required
- No service contracts required

Wiring diagrams

These pages illustrate examples of typical Pneumatic LCN systems. Please consult your local RSO representative or LCN for assistance with specific installations and material requirements.

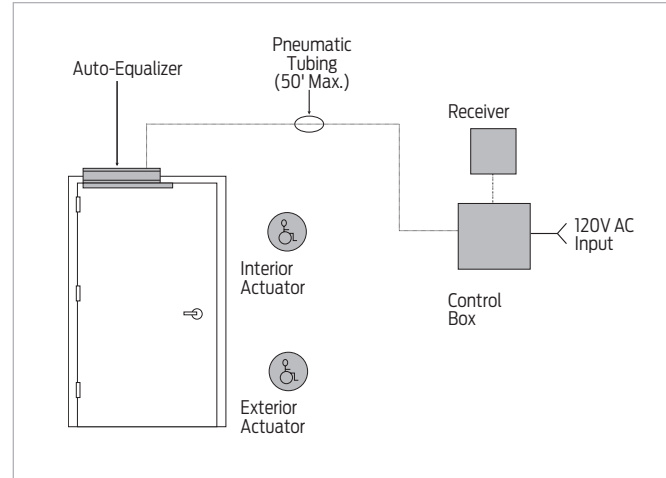
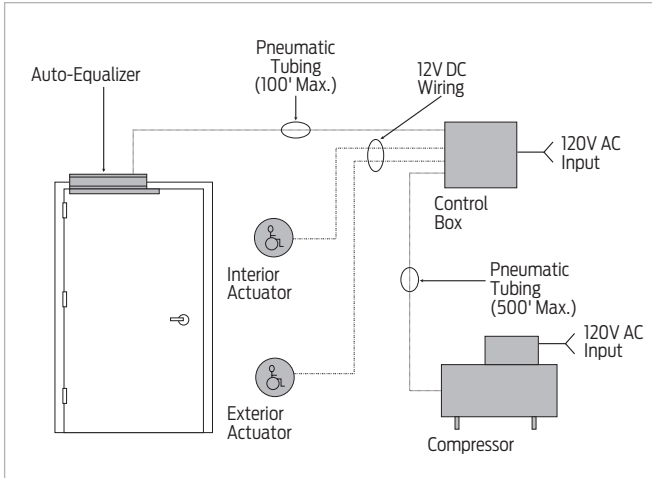

Single interior door system (wired)

- Slow opening interior door leaf
- System may be expanded to include an additional simultaneous door
- No guide rails or safety devices

How it works

- A person requiring assistance triggers the system using either actuator
- The control box supplies pressurized air to the auto equalizer which opens the door slowly to 90°, holds it for up to 30 seconds, then applies full spring power to reliably close and latch the door
- If not actuated, the auto equalizer functions as a full featured door closer

Bill of materials

Qty	Part number	Description
1	4811	Auto equalizer
1	8310-856	Hard wired wall mount, logo
1	8310-856	Hard wired wall mount, logo
1	7901	Control box
1		Compressor*
As needed	925	Tubing

* Contact Technical Support to verify compressor requirements.

Single interior door system (wireless)

- Slow opening automatic door on door leaf
- Wireless actuators
- Stand alone system, no planned expansion
- No guide rails or safety devices

How it works

- A person requiring assistance triggers the system using either actuator
- The wireless transmitter in the actuator sends a signal to the wireless receiver which triggers the control box
- The control box supplies pressurized air to the auto equalizer which slowly swings door to 90°, holds it for up to 30 seconds, then applies full spring power to reliably close and latch the door.
- If not actuated, the auto equalizer functions as a full featured door closer

Bill of materials

Qty	Part number	Description
1	4811	Auto equalizer
2	8310-3856WS	Wireless actuator, wall mount and surface, logo, 4 1/2" round
1	8310-865	Wireless receiver
1	7981	Control box
As needed	925	Tubing

Wiring diagrams

These pages illustrate examples of typical Pneumatic LCN systems. Please consult your local RSO representative or LCN for assistance with specific installations and material requirements.

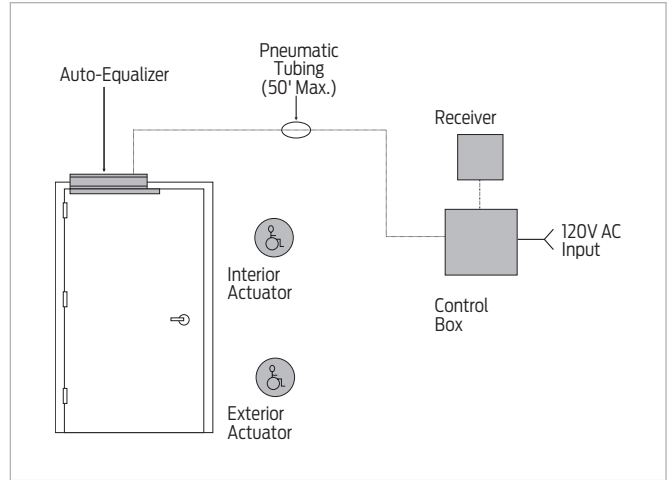
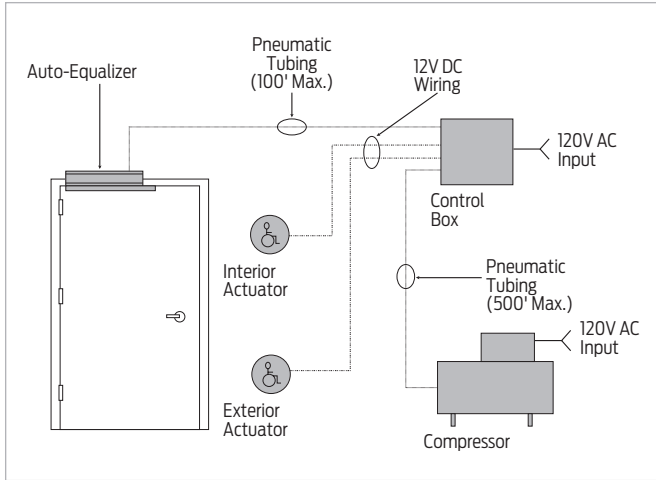

Alternate vestibule door system (wired)

- Slow opening automatic doors with sequential operation for exterior and vestibule pairs of doors
- No guide rails or safety devices

How it works

- People requiring assistance press exterior actuator for entry
- The exterior pair opens and after a short sequential delay the interior pair opens
- As the system times out, first the exterior, then the interior doors close
- Pressing the interior actuator reverses the process to exit the building
- This allows passage through the vestibule without all doors open for the entire cycle
- If a person stops in the vestibule and the system times out before they exit, pressing either vestibule actuator opens the appropriate doors
- Compressor is sized for multiple systems.; sequential operation is not recommended with scanners or motion sensors
- If not actuated, the auto equalizer functions as a full feature door closer

Bill of materials

Qty	Part number	Description
2	4822	Auto equalizer (exterior)
2	4811	Auto equalizer (interior)
1	7902S	Control box with sequencer card
1		Compressor*
4	8310-856	Hard wired wall mount, logo
As needed	925	Tubing

* Contact Technical Support to verify compressor requirements.

Vestibule door system (wireless)

- Slow opening automatic doors with sequential operation for single exterior and vestibule doors
- No guide rails or safety devices

How it works

- People requiring assistance press exterior actuator for entry
- The exterior door opens and after a short delay the interior door opens
- When the system times out, first the exterior, then the interior door closes
- Pressing the interior actuator reverses the process to exit the building
- This allows passage through the vestibule without both doors open for the entire cycle
- If a person stops in the vestibule and the system times out before they exit, pressing either vestibule actuator opens the appropriate door
- Sequential operation is not recommended with scanners or motion sensors
- If not actuated, the auto equalizer functions as a full featured door closer

Bill of materials

Qty	Part number	Description
1	4822	Auto equalizer (exterior)
1	4811	Auto equalizer (interior)
1	7902S	Control box with sequencer card
4	8310-3856WS	Wireless actuator, wall mount and surface, logo, 4 1/2" round
2	8310-865	Wireless receiver
As needed	925	Tubing

2610 Series



The 2610 Auto Equalizer™ is LCN's pneumatically powered multi-door solution. This low-energy automatic operator provides easy access for people with disabilities, or the elderly. Designed primarily for manual opening applications that occasionally require automatic opening.

Features

Certifications	ADA, 100 Hour Salt Spray, Meets BAA - Buy American Act	Mounting	Concealed in frame
Body construction	<ul style="list-style-type: none"> Cast iron body Full complement bearing 1 1/2" diameter piston 1/16" diameter double heat treated pinion journal 	Arms	Single lever arm, mounting/finish plate, standard track
Fluid	All weather fluid	Finishes/colors/powder coat	<ul style="list-style-type: none"> 689 Aluminum 690 Statuary Bronze 691 Light Bronze 693 Black 695 Dark Bronze 696 Brass Custom colors optional Optional SRI primer - powder coat only Optional plated finishes
Handing	Handed		
Size	Sized 3 and 4		
Warranty	2 years		
Fasteners	Wood and Machine Screws (WMS)		

Special templates

Customized installation templates or products may be available to solve non-standard applications. Contact LCN Product Support for assistance.

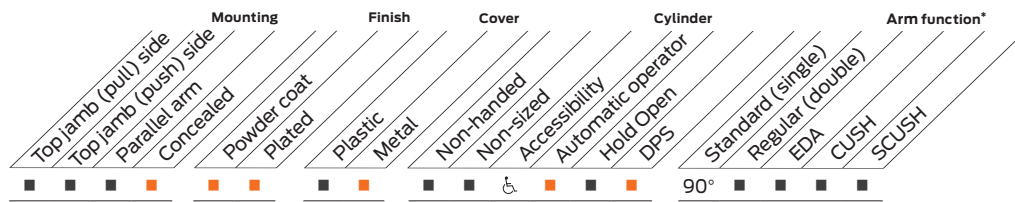

■ Available
 ■ Not available

♿ Meets ADA requirements (power mode).
 * See individual series for maximum manual opening.

Mounting details

Concealed mounting

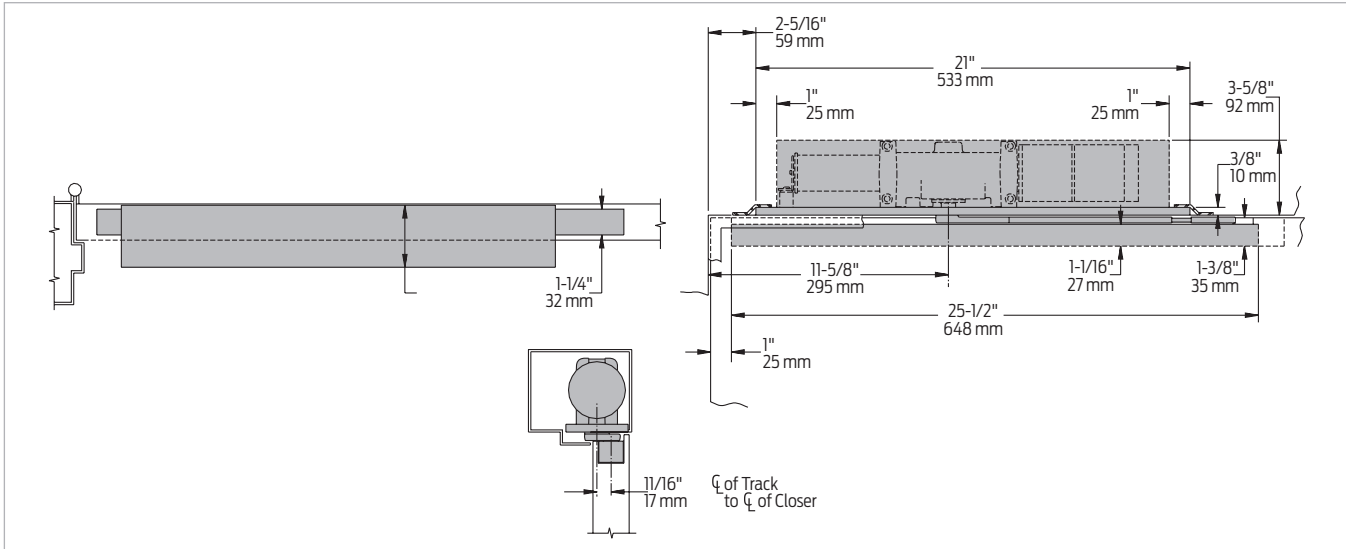

Butt hinges	Should not exceed 5" (127 mm) in width
Auxiliary stop	Recommended
Top rail	<ul style="list-style-type: none"> 1 3/8" (35 mm) mortise required 5/16" (8 mm) cutout required at top of the door, push side only
Head frame	Minimum 4" (102 mm) x 4" for hollow metal or aluminum tube construction
System diagram	See pages 9-10 for typical system wiring, and pages 28-29 for electrical and pneumatic data for control boxes
Maximum opening	<ul style="list-style-type: none"> Butt hinge template allows 90° power opening and 160° manual opening Please note that many track style door closers are capable of allowing 180° of door swing Track style closers are at their weakest closing force at 180° Consult factory for applications where exterior or large/heavy door must swing 180° Consult factory for all pivot mounted installations

Notes:

- For interior or exterior doors
- Single acting cylinder in head frame
- Concealed arm and track in door top rail
- Requires control box with integral compressor or control box using auxiliary air supply (see control box pages 28-29 and actuators and accessories, pages 100-117)
- Guard rails/safety mats not required

Accessories

Cylinders

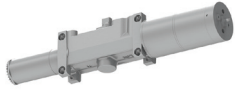

2610-3971
Cast Iron Cylinder
Assembly (CYL)

- Handed
- Standard

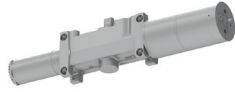

2610-3971 DPS
Cast Iron Cylinder Assembly
(CYL)

- Handed
- With Door Position Switch (DPS) which sends signal when door is closed
- Standard



2610-3071
Cast Iron Cylinder
Assembly (CYL)

- Handed
- Mounting plate
- Standard



2610-3071 DPS
Cast Iron Cylinder Assembly
(CYL)

- Handed
- Mounting plate with Door Position Switch (DPS) which sends signal when door is closed
- Standard

Arms



2610-3077T
Standard Arm (STDTRKARM)

- Handed
- Track roller not included with arm

Tracks



2610-3038
Standard Track (STDTRK)

- Non-handed
- Standard

Installation accessories



2610-3034
Track roller

- Quiet, low friction roller assembly
- Shoulder dimension "X" = 1/16" (2 mm)

Ordering information

How-to-order 2610 Series operators

- | | | |
|--|---|--|
| <p>1. Select cylinder size</p> <ul style="list-style-type: none"> <input type="checkbox"/> 2613 <input type="checkbox"/> 2613 DPS <input type="checkbox"/> 2614 <input type="checkbox"/> 2614 DPS | <p>2. Specify hand</p> <ul style="list-style-type: none"> <input type="checkbox"/> Right Hand (RH) <input type="checkbox"/> Left Hand (LH) | <p>3. Select finish</p> <ul style="list-style-type: none"> <input type="checkbox"/> Standard powder coat _____ Aluminum (689), Dark Bronze (695), Statuary Bronze (690), Light Bronze (691), Black (693), Brass (696) |
|--|---|--|

Operator will be shipped with:

- Standard arm
- Track roller
- Standard track
- Wood and machine screw pack (unless options listed below are selected)

Operator options

Finish

- Custom Powder Coat (RAL) _____
- Plated finish _____

Screw pack

- Wood and Machine Screws (WMS)

Special template

- ST- _____

Table of sizes

- Select closer based on width of door
- Sized 2610 Series cylinders available in size 3 or 4
- Closing power of all 2610 Series closers may be increased 15%

Exterior (and vestibule) door width

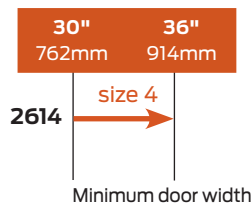

Interior door width

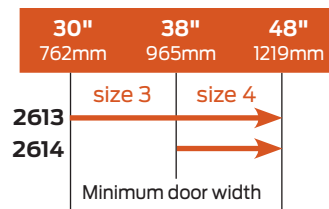

➔ Indicates recommended range of door width for operator.
 Note: Minimum door width 30" (762mm).

4810 Series



The 4810 Auto Equalizer™ is LCN's pneumatically powered multi-door solution. This low-energy automatic operator provides easy access for people with disabilities, or the elderly. Designed primarily for manual opening applications that occasionally require automatic opening.

Features

Certifications	ADA, 100 Hour Salt Spray, Meets BAA - Buy American Act	Cover	Metal Cover (MC)
Body construction	<ul style="list-style-type: none"> Cast iron body Full complement bearing 1 1/2" diameter piston 3/4" diameter double heat treated pinion journal 	Fasteners	Wood and Machine Screws (WMS)
Fluid	All weather fluid	Mounting	Top jamb (pull side)
Handing	Non-handed	Arms	Single lever arm with standard track
Size	Adjustable spring size 1-4	Finishes/colors/ powder coat	<ul style="list-style-type: none"> 689 Aluminum 690 Statuary Bronze 691 Light Bronze 693 Black 695 Dark Bronze 696 Brass Custom colors optional Optional SRI primer - powder coat only Optional plated finishes
Warranty	2 years		

Special templates | Customized installation templates or products may be available to solve non-standard applications. Contact LCN Product Support for assistance.

Mounting	Finish	Cover	Cylinder	Arm function*
<ul style="list-style-type: none"> Top jamb (pull) side Top jamb (push) side Parallel arm Concealed Powder coat Plated 	<ul style="list-style-type: none"> Plastic Metal 	<ul style="list-style-type: none"> Non-handed Non-sized Accessibility Automatic operator Hold open DPS 	<ul style="list-style-type: none"> 90° Standard (single) Regular (double) EDA CUSH SCUSH 	

■ Available ■ Not available Meets ADA requirements (power mode).
 * See individual series for maximum manual opening.

Mounting details

Top jamb (pull side) mounting

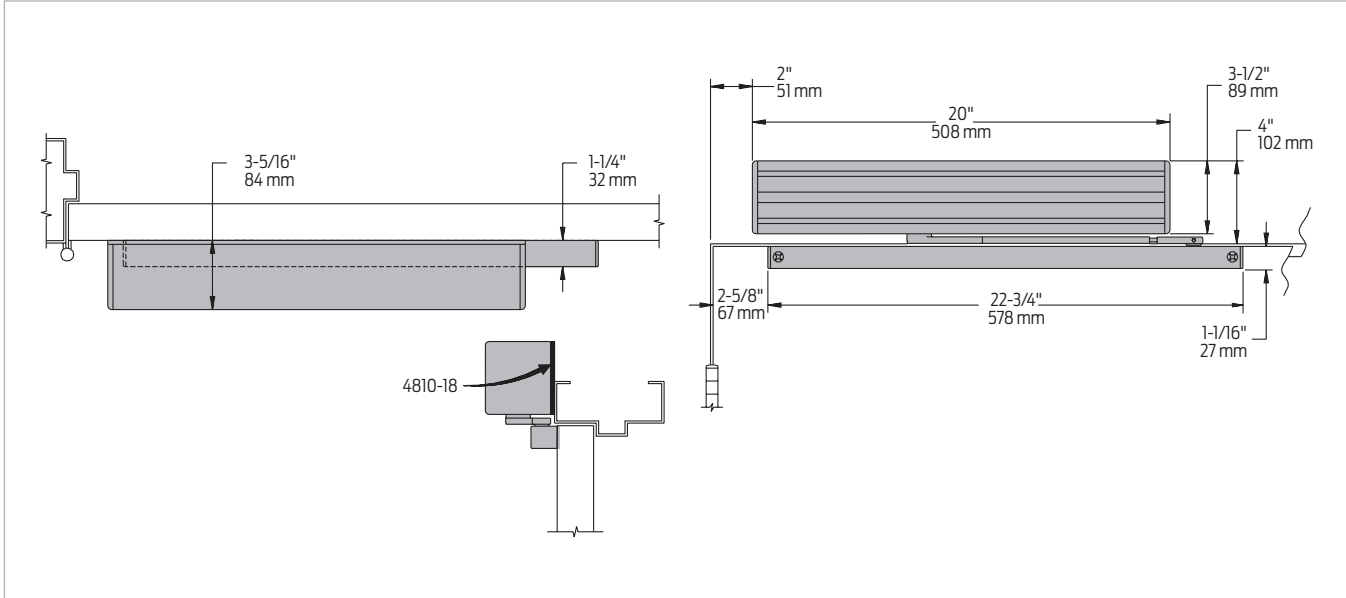

Butt hinges	Should not exceed 5" (127 mm) in width
Auxiliary stop	Recommended
Reveal	Should not exceed 1/8" (3 mm)
Top rail	Minimum 1 1/8" (29 mm)
Head frame	Minimum 2" (51 mm)
System diagram	See pages 9-10 for typical system wiring, and pages 28-29 for electrical and pneumatic data for control boxes
Maximum opening	<ul style="list-style-type: none"> ▪ Templating allows 90° power opening and 170° manual opening ▪ Please note that many track style door closers are capable of allowing 180° of door swing ▪ Track style closers are at their weakest closing force at 180° ▪ Consult factory for applications where exterior or large/heavy door must swing 180°

Notes:

- Requires control box with integral compressor or control box using auxiliary air supply
- See control box pages 28-29 and actuators and accessories, pages 100-117
- Guard rails/safety mats not required

Accessories

Cylinders



- 4811-3971**
Cast Iron Cylinder Assembly (CYL)
- Non-handed
 - Standard



- 4811-3071**
Cast Iron Cylinder Assembly (CYL)
- Non-handed
 - Mounting plate
 - Standard

Covers

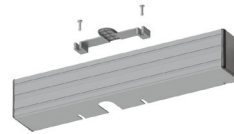

- 4810-72MC**
Metal Cover (MC)
- Non-handed
 - With black end caps
 - Standard

Arms



- 4810-3077T**
Standard Arm (STDTRKARM)
- Non-handed
 - Track roller not included with arm

Tracks



- 4810-3038**
Standard Track (STDTRK)
- Non-handed
 - Standard

Installation accessories



- 4810-3034**
Track roller
- Quiet low friction roller assembly
 - Shoulder dimension "X" = 1/8" (3mm)

Ordering information

How-to-order 4810 Series operators

1. Select finish

- Standard powder coat _____
Aluminum (689), Dark Bronze (695),
Statuary Bronze (690), Light Bronze
(691), Black (693), Brass (696).

Operator will be shipped with:

- Standard cylinder
- Metal cover
- Standard arm
- Track roller
- Standard track
- Wood and machine screws
(unless options listed below are selected)

Operator options

Finish

- Custom Powder Coat (RAL) _____
- Plated finish _____ (cover only)

Screw packs

- Through Bolt¹ Wood and Machine Screws
(TBWMS)

Special template

- ST- _____

1. Specify door thickness if other than 1 3/4".

Table of sizes

- Non-sized 4810 Series cylinder is adjustable from size 1 through size 4 and is shipped set to size 3
- Closing power of 4810 Series closers may be increased 50%

Exterior (and vestibule) door width

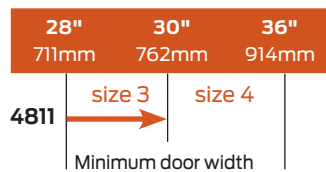

Interior door width

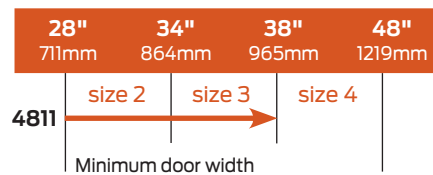

→ Indicates recommended range of door width for operator.
Note: Minimum door width 28" (711 mm).

4820 Series



The 4820 Auto Equalizer™ is LCN’s pneumatically powered multi-door solution. This low-energy automatic operator provides easy access for people with disabilities, or the elderly. Designed primarily for manual opening applications that occasionally require automatic opening.

Features

Certifications	ADA, 100 Hour Salt Spray, Meets BAA - Buy American Act	Cover	Metal Cover (MC)
Body construction	<ul style="list-style-type: none"> Cast iron body Full complement bearing 1 1/2" diameter piston 3/4" diameter double heat treated pinion journal 	Fasteners	Wood and Machine Screws (WMS)
Fluid	All weather fluid	Mounting	Top jamb (push side)
Handing	Non-handed	Arms	<ul style="list-style-type: none"> Regular Arm (REGARM), standard Long Arm (LONG), optional
Size	Adjustable spring size 2-5	Finishes/colors/ powder coat	<ul style="list-style-type: none"> 689 Aluminum 690 Statuary Bronze 691 Light Bronze 693 Black 695 Dark Bronze 696 Brass Custom colors optional
Warranty	2 years		<ul style="list-style-type: none"> Optional SRI primer - powder coat only Optional plated finishes

Special templates

Customized installation templates or products may be available to solve non-standard applications. Contact LCN Product Support for assistance.

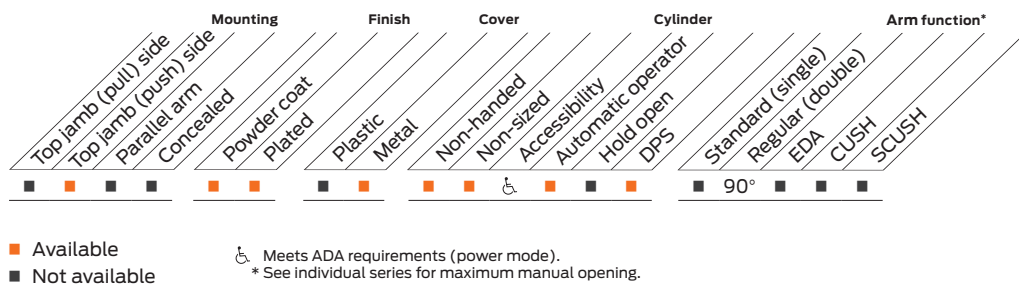

Pneumatic powered systems

Mounting details

Top jamb (push side) mounting

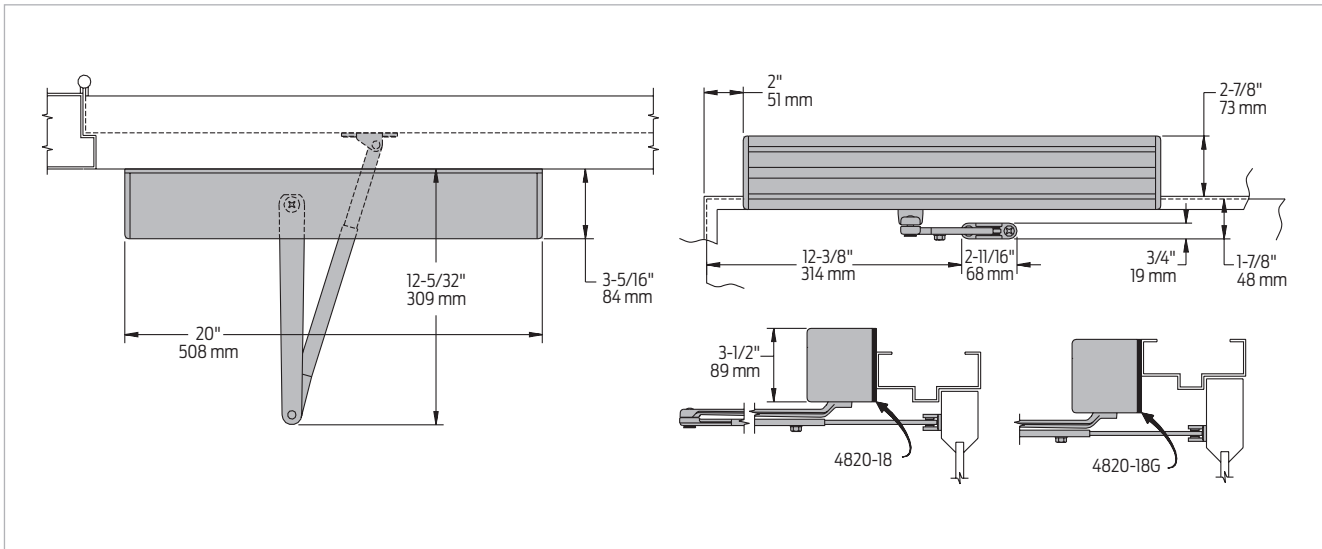

Butt hinges	Should not exceed 5" (127 mm) in width
Auxiliary stop	Recommended
Reveal	<ul style="list-style-type: none"> 4 1/2" (114 mm) allows up to 90° power opening and 100° manual opening 8" (203 mm) allows up to 90° power opening and 100° manual opening with long arm where standard rod and shoe is replaced with optional long rod and shoe, 4820-79LR
Top rail	<ul style="list-style-type: none"> Minimum 1 3/4" (44 mm) Closer on 4820-18G plate requires 3" (76 mm) minimum
Head frame	<ul style="list-style-type: none"> Minimum 1 3/4" (44 mm) With flush ceiling use plate, 4820-18G substituted for standard plate
System diagram	See pages 9-10 for typical system wiring, and pages 28-29 for electrical and pneumatic data for control boxes
Maximum opening	Templating allows 90° power opening and 100° manual opening
Options	Door Position Switch (DPS) kit that signals when the door has reached the open position

Notes:

- Requires control box with integral compressor or control box using auxiliary air supply
- See control box pages 27-29 and actuators and accessories, pages 100-117
- Guard rails/safety mats not required

Accessories

Cylinders



- 4822-3971
Cast Iron Cylinder
Assembly (CYL)**
- Non-handed
 - Standard



- 4822-3071
Standard Cylinder with 18G
mounting plate (CYL18G)**
- Non-handed
 - Includes; 4820-18 Mounting Plate or 4820-18G Mounting Plate (must specify)
 - Standard

Covers

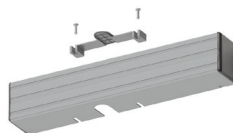

- 4820-72MC
Metal Cover (MC)**
- Non-handed
 - With black end caps
 - Standard

Arms



- 4820-3077
Regular Arm (REGARM)**
- Non-handed
 - Standard



- 4820-3077L
Long Arm (LONG)**
- Includes long rod and shoe, 4820-79LR for deep reveals
 - Optional

Installation accessories



- 4820-18
Plate**
- Requires minimum 1 3/4" (44 mm) minimum head frame and 2" (51 mm) top rail
 - Standard



- 4820-18G
Plate**
- Requires minimum 1 3/4" (44 mm) minimum head frame and 2" (51 mm) top rail
 - Standard



- 4820-3377
Door Position Switch Kit**
- Provides feedback when the door reaches the fully opened position
 - Specify RH or LH when ordering

Pneumatic powered systems

Ordering information

How-to-order 4820 Series operators

1. Select finish

- Standard powder coat _____
Aluminum (689), Dark Bronze (695), Statuary Bronze (690), Light Bronze (691), Black (693), Brass (696).

Operator will be shipped with:

- Standard cylinder
- Metal cover
- Regular arm
- Wood and machine screws
(unless options listed below are selected)

Operator options

Finish

- Custom Powder Coat (RAL) _____
- Plated finish _____

Arm

- Long Arm (LONG)

Screw packs

- Through Bolt¹ Wood and Machine Screws (TBWMS)

Installation accessories

- Plate, 4820-I8
- Plate, 4820-I8G
- Door Position Switch Kit, 4820-3377 LH
- Door Position Switch Kit, 4820-3377 RH

Special template

- ST- _____

1. Specify door thickness if other than 1 3/4".

Table of sizes

- Non-sized 4820 Series cylinder is adjustable from size 2 through size 5 and is shipped set to size 3
- Closing power of 4820 Series closers may be increased 50%

Exterior (and vestibule) door width



Interior door width

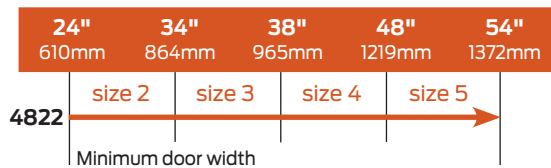

➔ Indicates recommended range of door width for operator.

4840 Series



The 4840 Auto Equalizer™ is LCN's pneumatically powered multi-door solution. This low-energy automatic operator provides easy access for people with disabilities, or the elderly. Designed primarily for manual opening applications that occasionally require automatic opening.

Features

Certifications	ADA, 100 Hour Salt Spray, Meets BAA - Buy American Act	Fasteners	Adjustable Spring Size 1-5
Body construction	<ul style="list-style-type: none"> Cast iron body Full complement bearing 1 1/2" diameter piston 3/4" diameter double heat treated pinion journal 	Mounting	Parallel arm (push side)
Fluid	All weather fluid	Arms	Extra duty, standard; Cush-n-Stop and Spring Cush-n-Stop, optional
Handing	Non-handed	Finishes/colors/ powder coat	<ul style="list-style-type: none"> 689 Aluminum 690 Statuary Bronze 691 Light Bronze 693 Black 695 Dark Bronze 696 Brass Custom colors optional
Size	Adjustable spring size 1-5		<ul style="list-style-type: none"> Optional SRI primer - powder coat only Optional plated finishes*
Warranty	2 years		*End caps are black
Cover	Metal Cover (MC)		

Special templates

Customized installation templates or products may be available to solve non-standard applications. Contact LCN Product Support for assistance.

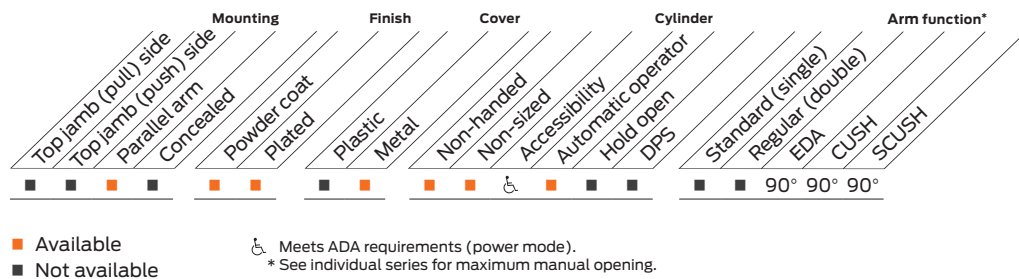

Mounting details

Parallel arm (push side) mounting

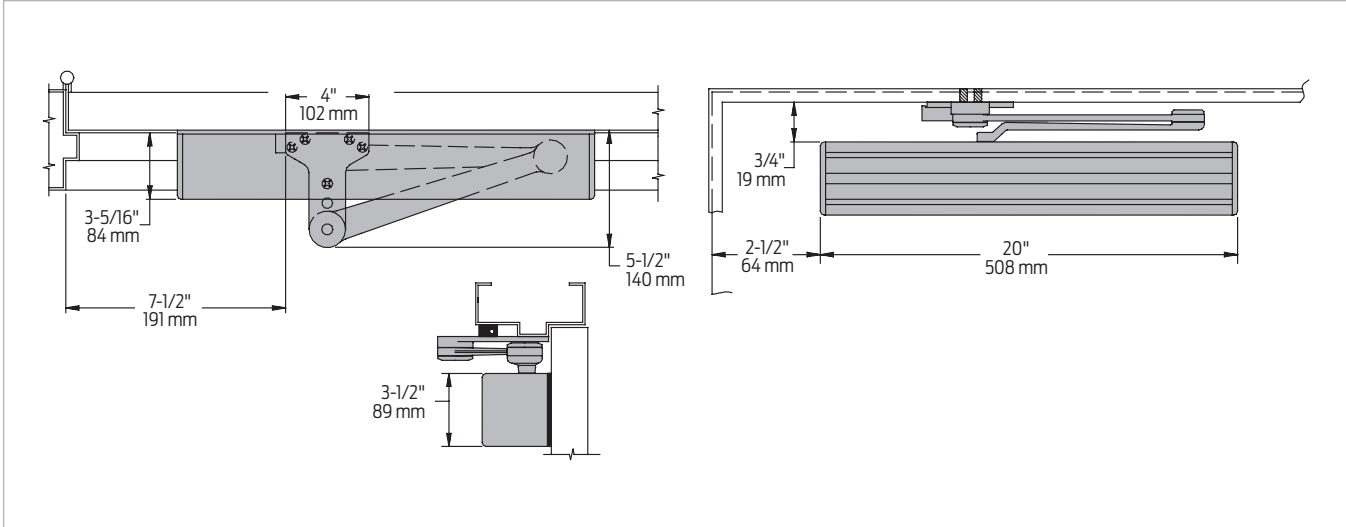

Butt hinges	Should not exceed 5" (127 mm) in width
Auxiliary stop	Recommended when Cush-n-Stop (CUSH) or Spring Cush-n-Stop (SCUSH) arms are not used
Clearance	EDA or CUSH shoes is 5-1/2" (140 mm) from door face
Top rail	Minimum 4-1/8" (105 mm), 6" minimum top rail for screw not to show in glass
Head frame	(Flush) requires PA shoe adapter, 4840-419
Stop width	Minimum 1" (25 mm)
Blade stop	Clearance requires 1/2" (13 mm) blade stop spacer, 4840-61
System diagram	See pages 9-10 for typical system wiring, and pages 28-29 for electrical and pneumatic data for control boxes
Maximum opening	<ul style="list-style-type: none"> ▪ Maximum power opening is 90° with all arms ▪ Maximum manual opening is 105° with EDA or SCUSH arms ▪ Maximum manual opening is 100° with CUSH arm

Notes:

- For CUSH or SCUSH arm installations with maximum opening less than listed above, consult factory for special template
- Requires control box with integral compressor or control box using auxiliary air supply
- See control box pages 28-29 and actuators and accessories, pages 100-117
- Guard rails/safety mats not required

Accessories

Cylinders



4841-3971
Cast Iron Cylinder Assembly (CYL)

- Non-handed
- Standard

4841-3071
Cast Iron Cylinder Assembly (CYL)

- Non-handed
- Mounting plate
- Standard

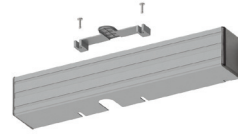
Covers

4840-72MC
Metal Cover (MC)

- Non-handed
- With black end caps
- Standard

Arms

4840-3077EDA
Extra Duty Arm (EDA)

- Non-handed
- Features forged solid steel main arm and forearm for potentially abusive installations
- Standard

4840-3077CNS
Cush-n-Stop Arm (CUSH)

- Non-handed
- Features forged solid steel main arm and forearm with stop in soffit shoe
- Optional

4840-3077SCNS
Spring Cush-n-Stop Arm (SCUSH)

- Non-handed
- For abusive applications features forged solid steel main arm and forearm with spring loaded stop in soffit shoe
- Optional

Installation accessories

4840-30
CUSH Shoe Support

- Provides anchorage for fifth screw used with EDA and CUSH arms, where reveal is less than $3 \frac{1}{16}$ " (78 mm)

4840-61
Blade Stop Spacer

- Required to lower parallel arm shoe to clear $\frac{1}{2}$ " (13 mm) blade stop

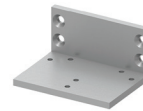
4840-419
PA Flush Panel Adapter

- Provides horizontal mounting surface for parallel arm shoe on single rabbeted or flush frame

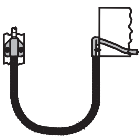
4840-459
Door Loop Kit

- Surface mounted, flexible metal loop transfers pressurized air via pneumatic tubing from frame to closer end cap
- Extra caps allow tubing to run on frame surface or concealed in the frame

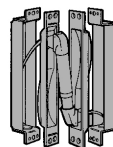
4840-460
Pneumatic Transfer Hinge

- Transfers pressurized air via pneumatic tubing from frame to door leaf for fully concealed installations
- Preparation of a raceway is required from the hinge stile of the door to the top rail for concealment of the pneumatic tubing within the door leaf

Ordering information

How-to-order 4840 Series operators

1. Select finish

- Standard powder coat _____
Aluminum (689), Dark Bronze (695),
Statuary Bronze (690), Light Bronze
(691), Black (693), Brass (696).

Operator will be shipped with:

- Standard cylinder
- Metal cover
- Extra duty arm
- Wood and machine screws
(unless options listed below are selected)

Operator options

Finish

- Custom Powder Coat (RAL) _____
- Plated finish _____

Arm

- Cush-n-Stop arm (CUSH)
- Spring Cush-n-Stop arm (SCUSH)

Screw packs

- Through Bolt¹ Wood and Machine Screws (TBWMS)

Installation accessories

- CUSH Shoe Support, 4840-30
- Blade Stop Spacer, 4840-61
- PA Flush Panel Adapter, 4840-419
- Door Loop Kit, 4840-459
- Pneumatic Transfer Hinge, 4840-460

Special template

- ST- _____

1. Specify door thickness if other than 1 3/4".

Table of sizes

- Non-sized 4841 cylinder is adjustable from size 1 through size 5 and is shipped set to size 3
- Closing power of 4841 closers may be increased 50%

Exterior (and vestibule) door width

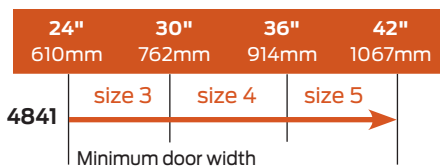

Interior door width



➔ Indicates recommended range of door width for operator.

7900 Series control boxes

A heavy duty, surface mounted control box contains one or two electrically controlled pneumatic circuits. Air filtration, pneumatic regulation, and system timing is performed by the control box. 7980 Series control boxes also contain a built-in air pump to power the system. Each pneumatic circuit can be adjusted for a hold open time up to 30 seconds. Output air pressure can be adjusted to precisely tailor system to individual door requirements.

Pneumatic connections use standard barbed fittings and 925 tubing from the compressor to the control box to the operator. A package of barbed tee and butt connectors are supplied with each control box to simplify installations. Consult LCN for details. Other than a semi-annual inspection of the air filter assembly and muffler, no periodic system maintenance is required.

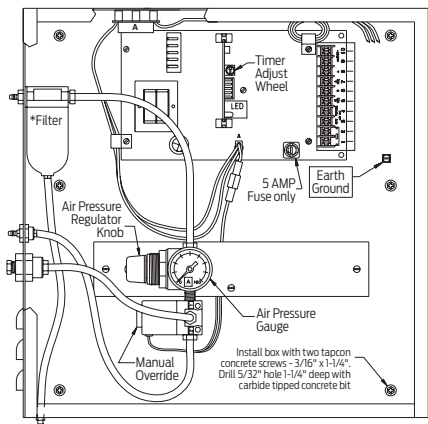

7901 and ES7901 control box

- For single door applications or independent control of single door in multiple door systems
- Two door leaves can be operated, if they are activated simultaneously
- The single pneumatic circuit accepts Normally Open (N.O.) inputs from hardwired or RF (wireless) actuator/receiver combinations
- The 7901 control box requires a separate compressor

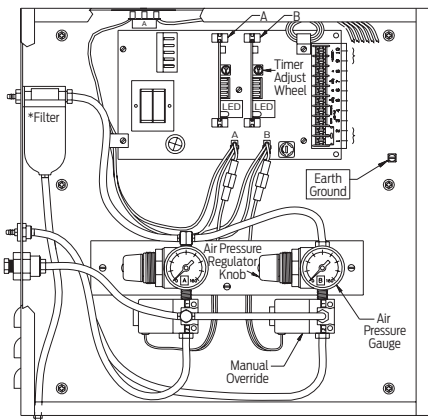

7902 and ES7902 control box

- For independent operation of two door or four door leaves, if pairs are actuated simultaneously
- Two independent pneumatic circuits accept Normally Open (N.O.) inputs from hardwired or RF (wireless) actuator/receiver combinations
- Sequential operation (add suffix "S") is available for 7902
- The 7902 control box requires a separate compressor

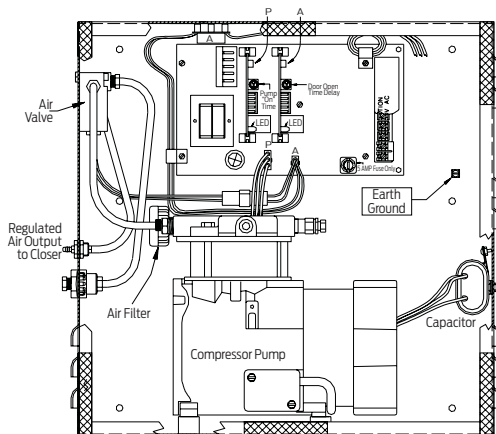

7981 and ES7981 control box

- Self-contained control box/compressor combination for single door leaf applications
- The single pneumatic circuit accepts Normally Open (N.O.) inputs from hardwired or RF (wireless) actuator/receiver combinations
- The 7981 control box does not require a separate compressor

Introduction
 Product selection guide
 Pneumatic systems
 Auto equalizers
 2610/4810/4820/4840/7900 Series
 Electrohydraulic systems
 Auto equalizers
 4630/4640 Series
 Electromechanical systems
 Benchmark
 9130/9140/9150 Series
 Electromechanical systems
 Senior Swing
 2810/2850/2860/9530/9540/9550/9560 Series
 Actuators and accessories

Pneumatic powered systems

7900 Series control boxes

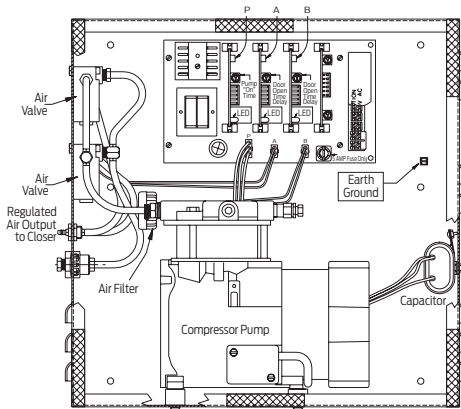
**7982 and ES7982 control box**

- Self-contained control box/compressor combination for independent or simultaneous operation of two door leaves
- Two independent pneumatic circuit accepts Normally Open (N.O.) inputs from hardwired or RF (wireless) actuator/receiver combinations
- The 7982 control box does not require a separate compressor
- Sequential operation (add suffix "S") is available for 7982 control boxes

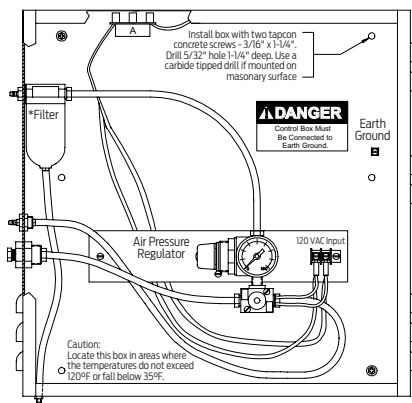
**7949 and ES7949 control box**

- Auxiliary "blow-open" box works with or without 7901 or 7902 and one or two Auto Equalizers
- Controlled by smoke evacuation system, the 7949 open the door(s) to allow fresh air into the building
- Normal Auto Equalizer functions are not available when "blowopen" box is activated

Optional "ES" boxes

- Identical in function(s) to the basic box but includes an isolated (SPDT) relay with 1 set of Normally Open (N.O.) and Normally Closed (N.C.) contacts to control an electric strike
- The LCN control box cannot power the strike. ES7949 has two sets of isolated (DPDT) contacts. Compressor size recommendations are based on normal usage for the number of operations listed
- All LCN supplied auxiliary compressors include an automatic drain feature

Control Box installation notes

- Locate a 7900 Series control box so no more than 100 linear feet of LCN 925 pneumatic tubing is required between the control box and door. Maximum 50 linear feet for a 7980 and 7949 Series
- Locate a 7900/7980/7949 Series control box where the temperatures do not exceed 120°F or fall below 35°F
- 7901, 7902 and 7949 control box input 120V AC @ 1 amp. 7981 and 7982 control boxes input 120V AC @ 5 amp
- Output voltage is 12V DC @ 0.25 amp. max
- Air pressure input, 80 PSI minimum/100 PSI maximum, required for 7901, 7902 and 7949
- Regulated air output up to 80 PSI for Auto Equalizer
- Auto Equalizers require approximately 0.5 cfm airflow in heavy traffic
- All control boxes are 15" x 15" x 6"

Accessories

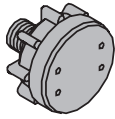

-329
Air Filter

- Replacement inlet air filter for 7981 or 7982 Series control boxes

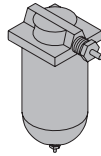

-329G
Air Filter

- Replacement inlet air filter assembly for 7901 or 7902 Series control boxes

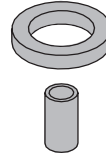

-929
Filter and Seal

- Internal filter and seal component to the Air Filter -329G assembly

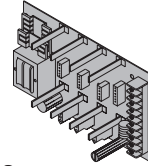

-900
Power Supply Board

- Main power supply/input board for the 7901, 7902, 7981, or 7982 Series control boxes

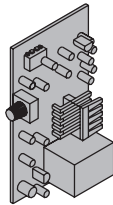

-903
Timer Card

- 0 to 30 second timer module
- Plugs into the power supply board, -900; 7901 (A slot) Series control box requires 1 each
- 7902 (A/B slots) and 7981 (P/A slots) Series control boxes require 2 each
- 7982 (P/A/B slots) Series control box requires 3 each

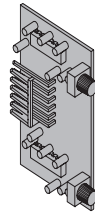

-3426
Sequencer Card

- Dual, 0 to 30-second sequence timer module for 7902 and 7982 Series control boxes
- Can be added to a standard 7902 or 7982 Series control box to convert to a sequential operation
- Sequencer card, -3426 is included when ordering a 7902S or 7982S Series control box

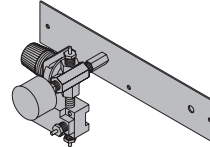

-941
Valve Assembly

- Regulator valve assembly for 7901 Series control box

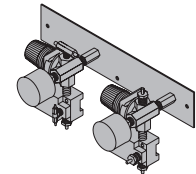

-942
Valve Assembly

- Regulator valve assembly for 7902 Series control box

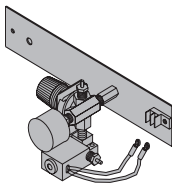

-941C
Valve Assembly

- Regulator valve assembly for 7949 Series blow open control box

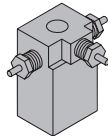

-3299A
Solenoid Valve Assembly

- Air valve assembly for 7981 Series control box or the 'A' circuit valve assembly for the 7982 Series control box

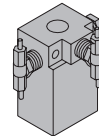

-3299B
Solenoid Valve Assembly

- Air valve assembly for the 'B' circuit in the 7982 Series control box

Introduction
 Product selection guide
 Pneumatic systems
 Auto equalizers
 2610/4810/4820/4840/7900 Series
 Electrohydraulic systems
 Auto equalizers
 4630/4640 Series
 Electromechanical systems
 Benchmark
 9130/9140/9150 Series
 Electromechanical systems
 Senior Swing
 2810/2850/2860/9530/9540/9550/9560 Series
 Actuators and accessories

Accessories

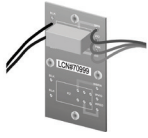

-3390A Relay Package "A"

- ES relay assembly for 7901 and 7981 Series control boxes or the 'A' circuit ES relay assembly in a 7902 or 7982 Series control boxes
- Includes 390 relay, base and wires
- Can be added to standard 7901, 7902, 7981 or 7982 Series control boxes to convert to ES operation
- Relay package, -3390A is included when ordering a 7901ES, 7902ES, 7981ES or 7982ES Series control box

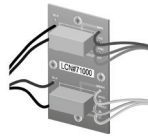

-3390B Relay Package "B"

- ES relay assembly for 'B' circuit in 7902 or 7982 Series control boxes
- Includes -390 relay, base and wires
- Can be added to standard 7902 or 7982 Series control boxes to convert to ES operation
- Relay package, -3390B is included when ordering a 7902ES or 7982ES Series control box

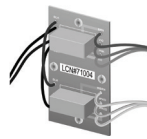

-3390C Relay Package "C"

- ES relay assembly in 7949 Series blow open control box
- Includes -390C relay, base and wires
- Can be added to standard 7949 Series blow open control box to convert to ES operation
- Relay package, -3390C is included when ordering a 7949ES Series control box



-962 Isolator

- Rubber isolators for 7981/7982 Compressor Assembly, -3960



-293G Muffler

- Exhaust muffler for 7901, 7902, 7949, 7981 and 7982 Series control boxes

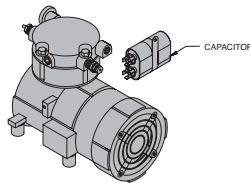

-3960 Compressor Assembly

- Internal air pump assembly for 7981 or 7982 Series control box
- Includes starter capacitor, -962 Isolators, and -329 Air Filter



-3592 Compressor Service Kit

- Internal component for pressure release valve on
 - 3960 Compressor Assembly



925 Pneumatic Tubing

- 1/8" (3mm) I.D. flexible pneumatic tubing for use with standard barbed fittings provided on pneumatic control boxes and operators
- Order by linear footage required
- 925 tubing is not plenum rated
- Contact LCN for applications where tubing must run through rated plenums

Electric auto equalizers

In addition to the original pneumatic drive system, LCN offers Automatic Electronic Equalizers. People moving through a door can use it as a normal rack and pinion door closer or, at the touch of a button, open the door automatically. An integrated digital control suite provides all electrical control functions. These self-contained units are suitable for use on single leaf doors or pair of doors where each leaf is equipped with an operator. The operator provides all the control and power elements into a single operator package, only some actuators are required to complete the system. Two surface mount models available — the 4630 mounts on the pull side of the door and the 4640 Series mounts on the push side of the door. Integrates a modified heavy-duty 4040XP Series cast iron cylinder.

Electric auto equalizer systems

- Exceeds proposed ANSI cycle test standard of 300,000 full load automatic operating cycles
- Power operation plus full door control
- For all applications, single or multi-door projects
- Opening time to back check no faster than 3 seconds
- Opening time 4 seconds or more to fully open
- Must remain fully open for at least 5 seconds
- Closing time from 90° to 10° no faster than 3 seconds
- Less than 15 pounds-force to stop door's motion
- Kinetic energy must not exceed 1.25 lbf-ft
- In event of failure; less than 15 lbf. to release latch, less than 30 lbf. to put door in motion, less than 15 lbf. to fully open door systems

Digital control box

Provides exceptionally precise control of a large range of built-in functions combined with superior durability and performance. Visual indications and digital readouts of all control function settings and activity make adjustments easy, fast and accurate.

Dual independent program memories

Each unit is pre-programmed to factory default settings. The installer can adjust the unit to meet the job site requirements. These field settings are locked into the computer's memory. Any subsequent field adjustments replace the original field adjustments. The factory settings are always retained in memory and can be recalled to replace the field settings in just seconds, restoring the unit to its original programming.

On-board diagnostics

A sophisticated built-in diagnostics program monitors the system microprocessor, power supplies, drive system and actuators circuitry. This reduces the time required to make sure the installation is complete and correct.

On-board power supply

Provides both 12V DC and 24V DC outputs to power card readers, manual actuators and other peripherals.

“No Destruct” drive system

Specially designed motor and clutch assembly reduces the chance the operator will be damaged in an abusive application. If a vandal tries to force the door closed while it is trying to open, the clutch mechanism prevents damage. The door has improved control because the heavy duty 4040XP closer is always operable.

Electronic circuit protection

The high voltage input circuit is protected by a one amp slow blow fuse. The low voltage output circuits by self-resetting fuses.

Visual function indicators

LED's allow direct observation of these inputs:

- Input power
- Fire alarm input
- Normal trigger (actuator) input
- Sequential trigger (actuator) input
- Hold open/alternate action (actuator) input
- Lockout timer
- Safety sensor (clear) input
- Safety sensor (active) input

Programming mode

Allows tailoring of the following functions to meet specific site conditions:

- Hold open time
- 90° Slow down time
- One shot input [on or off]
- Exterior mode [on or off] function to accommodate momentary resistance, like wind gusts, during the opening swing
- Electric strike delay timer
- Electric strike 3 second power function [on or off]
- Sequential trigger delay timer
- Alternate action timer
- Lockout timer

Standards, listings and approvals

- UL listed for Fire Door Operator (GUJY) and Door Operator System (FDDR) file R18222
- Tested and certified under ANSI Standard A156.19 (Refer to Section 2.1 and consult factory for details)
- ANSI Standard A117.1, Section 4.13.13
- ADA law, Section 4.13.12
- Listed for positive pressure plus UL 10B and UL 10C
- Wiring is compliant with both UL 325 and the NEC (Separation of high and low voltage)
- Consult the factory for other listings such as; State and Local Government regulations
- UL 10 C Listed for Fire Rated Door Operators with Automatic Closers, File No. (GUJY)

Warranty

2 year limited warranty. See General Information catalog for complete details.

Maintenance

- For best performance, mount operators according to the LCN installation instructions
- Periodic visual inspections are recommended
- No service contracts

Wiring diagrams

This page illustrates examples of typical electric LCN systems. Please consult your local RSO representative or LCN for assistance with specific installations and material requirements.

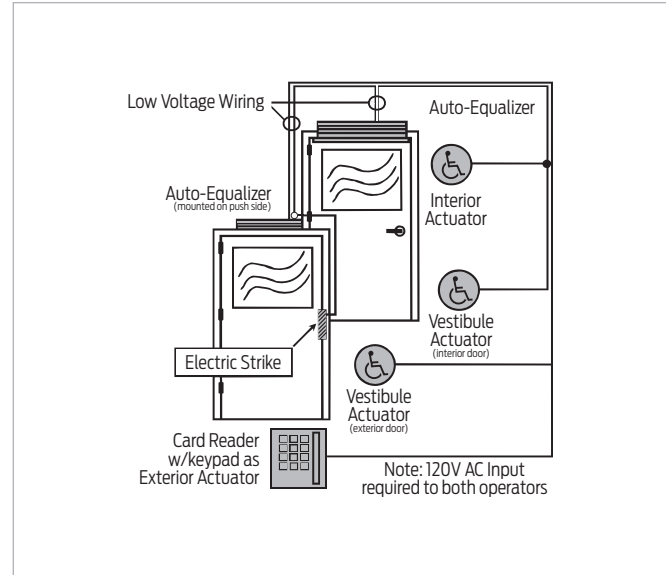
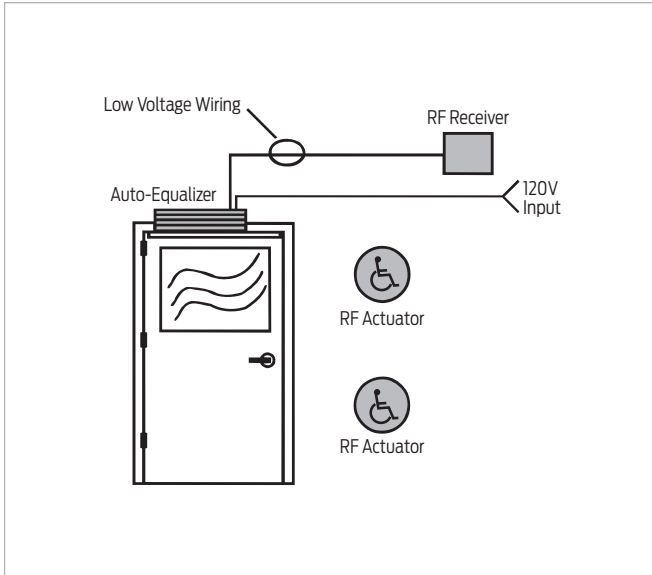

Single door system (wireless)

- An Interior Door
- No guide rails or safety devices
- Free swinging (or dogged) door

How it works

- Wireless RF actuators and receiver, powered by the auto equalizer simplify installation and minimize installation costs
- For automatic door operation, touching either actuator signals the receiver and controller module to open the door to 90°
- The door is held there until the system times out, then full spring power is applied to reliably close and latch the door.
- Door opening speed and hold open time are adjustable on the controller
- Closing power and speed are adjustable on the cylinder assembly
- If not actuated, the Auto Equalizer functions as a full featured door closer

Bill of materials

Qty	Part number	Description
1	4631	Auto equalizer
2	8310-3856WS	Wireless actuator, wall mount and surface, logo, 4 1/2" round
1	8310-865	Wireless receiver

Vestibule door system (wired)

- Exterior and vestibule doors
- Sequential operation
- No guide rails or safety devices
- Controlled access, free egress

How it works

- This installation provides both accessibility and security for building occupants
- The Auto Equalizer controller module provides both the power and coordination for card reader and electric strike applications
- A built-in delay allows the strike to release before the door begins to open
- Two interconnected Auto Equalizers provide sequential operation in both directions
- Vestibule actuators allow single door ingress/egress from the vestibule as needed

Bill of materials

Qty	Part number	Description
1	4642	Auto equalizer (exterior)
1	4631	Auto equalizer (interior)
3	8310-856	Hard wired wall mount, logo, 4 3/4" x 4 3/4"

Other products from Von Duprin and Locknetics

Note: An EL device requires a separate power supply. If not actuated, the auto equalizer functions as a full featured door closer.

Electrohydraulic powered systems

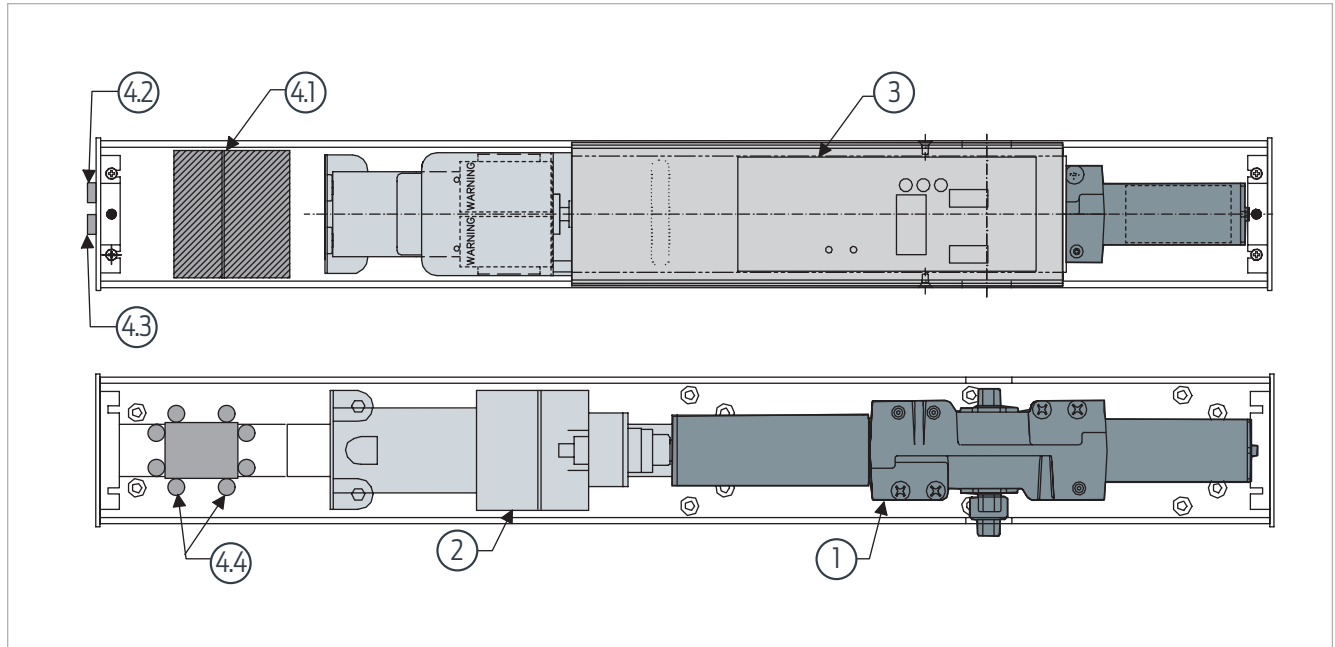

1. Door closer assembly

- Based on a heavy duty 4040XP, cast iron cylinder with allweather fluid for consistency and reliability
- Rugged drive mechanism provides the connection to the electric motor assembly
- Fully adjustable, independent hydraulic regulation controls the door to minimize the chance of damage to the door and frame assemblies

2. Electric motor/clutch assembly

- Highly efficient motor combined with a custom designed gear system provides exceptionally quiet and smooth operation
- Special clutch transmits the power and provides a unique function that prevents damage to the operator, door and frame if a vandal forces the door closed during the powered opening swing

3. Digital controller module

- Digital control suite
- Dual independent program memories
- On board diagnostics
- Visual function indicators
- Adjustable programming modes

4.X Field wiring

4.1

- Input power; 120V AC @ 1.5 amperes
- On-board, low voltage power supply provides both 12V and 24V DC @ 1.0 ampere (maximum combined load) for LCN actuators, RF receivers, and electric strikes or magnetic locks
- Slow blow and self-resetting fuses protect input and output power from voltage spikes
- Terminal strips simplify field wiring

4.2

- On/Off switch

4.3

- Hold open switch

4.4

- Separate conduits for high voltage power and low voltage power and signal wiring meet UL and National Electrical Code requirements

Control box and electrical connections

Digital control box	
Opening speed adjustment	Limited to a minimum of 3 seconds to back check (approx. 70°)
Opening force adjustment	Maximum of 15 lb-f to stop door swing adjustment
Time display	Displays numeric value relating to timing adjustments (16 = approx. 5 seconds)
Mode indicator	Indicates programming mode currently being displayed
Up button	Increases time or changes from OFF to ON when programming
Down button	Decreases time or changes from OFF to ON when programming
Mode button	Advances through programming setups on mode Indicator
Operating indicators	Displays operating information about internal functions and external hardware

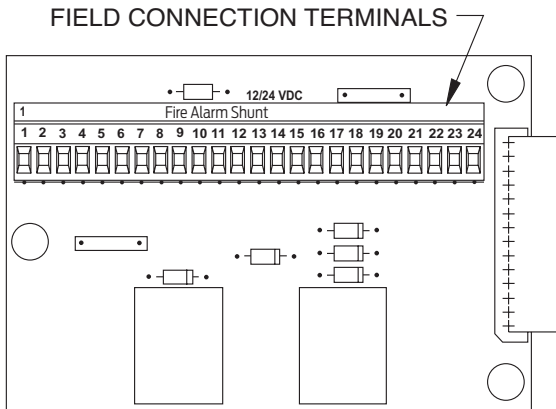
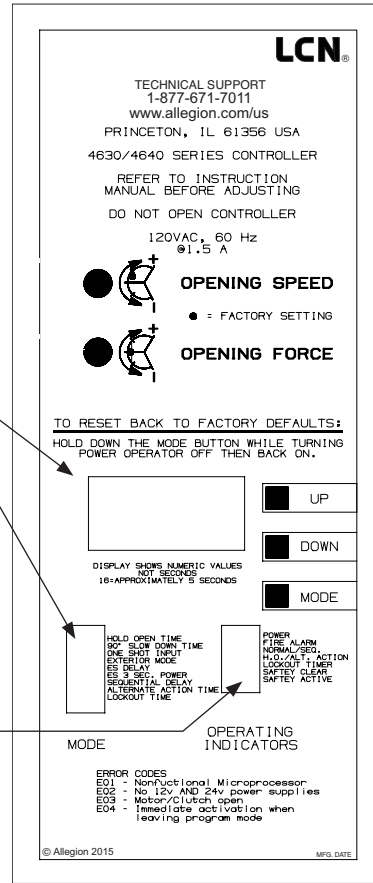

Low voltage (Class 2 NEC) electrical connections	
Function	Terminal
Actuator - Normal Input (N.O.)	16 and 17 or 18 and 1
Actuator - Sequential Input (N.O.)	8 and 19
Actuator - Alternate Action (N.O.)	15 and 17
Actuator - Continuous (N.O.)	6 and 17
Sequential Output	9
Stop Side Safety (N.O.)	19 and 2
Swing Side Safety (N.O.)	19 and 21
Fire Alarm Contact (N.C.)	13 and 14 (fire shunt)
Auxiliary Relay Contacts (5 amp max)	10 - Common 11 - N.O. 12 - N.C.
E.S. Relay Contacts (5 amp max)	22 - Common 23 - N.O. 24 - N.C.
12V DC and 24V DC Negative*	2, 4, 13, 17, and 19
12V DC Positive*	5 and 7
24V DC Positive*	1 and 3

* 1 Amp max load between 12V and 24V DC outputs.

4630 Series



The 4630 auto equalizer is LCN's smart and reliable electrically powered low-energy automatic operator. It provides easy access for people with disabilities, or the elderly. Designed primarily for manual opening applications that occasionally required automatic opening.

Features

Certifications	Grade 1 - ANSI A117.1, A156.19, UL 10C, UL 325/228, ADA, 100 Hour Salt Spray, Meets BAA - Buy American Act	Cover	Metal Cover (MC)
Body construction	<ul style="list-style-type: none"> Cast iron body Full complement bearing 1 1/2" diameter piston 3/4" diameter double heat treated pinion journal 	Fasteners	Wood and Machine Screws (WMS)
Fluid	All weather fluid	Mounting	Top jamb (pull side)
Handing	Non-handed	Arms	Standard single lever arm and track
Size	Adjustable spring size 1-4	Finishes/colors/ powder coat	<ul style="list-style-type: none"> 689 Aluminum 690 Statuary Bronze 691 Light Bronze 693 Black 695 Dark Bronze 696 Brass Custom colors optional Optional SRI primer - powder coat only Optional plated finishes*
Warranty	2 years		*End caps are black

Special templates | Customized installation templates or products may be available to solve non-standard applications. Contact LCN Product Support for assistance.

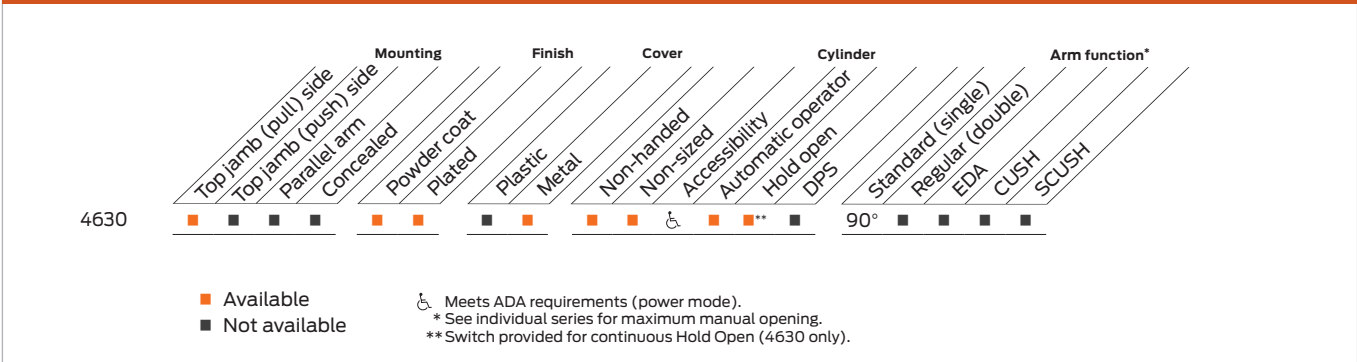

Mounting details

Top jamb (pull side) mounting

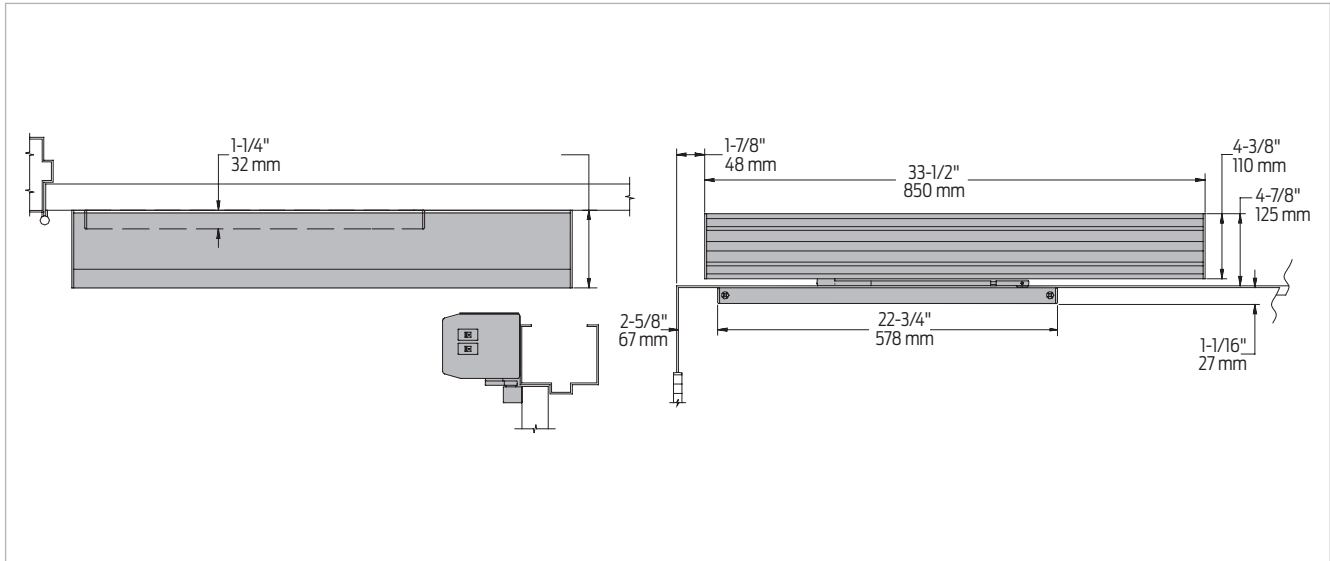

Butt hinges	Should not exceed 5" (127 mm) in width
Auxiliary stop	Recommended
Reveal	Should not exceed 1/8" (3 mm)
Top rail	Minimum 1 1/8" (29 mm)
Head frame	Minimum 2" (51 mm)
Opening time and force	<ul style="list-style-type: none"> Variable by adjustments to the electronic control module located on the operator assembly Maximum hold open time adjustable up to approximately five minutes
System diagram	See page 33 for typical system wiring and pages 34-35 for electrical data
Maximum opening	<ul style="list-style-type: none"> Templating allows 90° power opening and 170° manual opening Please note that many track style door closers are capable of allowing 180° of door swing Track style closers are at their weakest closing force at 180° Consult factory for applications where exterior or large/heavy door must swing 180°

Notes:

- Actuators are sold separately, see pages 100-117
- Comes with a digital control box utilizing a 4040XP heavy duty door closer with on-board diagnostics and power supply
- Has a factory default memory that include "No Destruct" drive system
- Guard rails or safety mats not required
- 4630 has easily accessible switches to provide on/off and continuous hold open functions
- CS options provides concealed on/off power switch
- Control module provides timing and sequential door functions, electric strike controls and adjustments for opening speed and force

Accessories

Cylinders



**4631-3971
Cast Iron Cylinder
Assembly (CYL)**

- Non-handed
- Standard

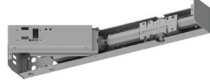

**4631-3071
Cast Iron Cylinder Assembly
(CYL)**

- Non-handed
- Mounting plate
- Includes 4630-3454 Motor Clutch, 4630-3180 I/O Board Assembly and 4630-3462 Controller
- Standard



**4631-3071CS
Cast Iron Cylinder Assembly (CYL)**

- Non-handed
- Mounting plate
- Includes 4630-3454 Motor Clutch, 4630-3180 I/O Board Assembly and 4630-3462 Controller
- Same as a 4630-3071 assembly except on/ off switch is concealed in endcap and no hold open switch is included (Separate key switches suggested)
- Optional

Covers

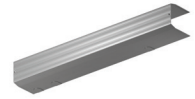

**4630-72MC
Metal Cover (MC)**

- Non-handed
- Standard

Arm



**4630-3077T
Standard Arm (STDTRKARM)**

- Non-handed
- Track roller not included with arm

Tracks



**4630-3038
Standard Track (STDTRK)**

- Non-handed
- Standard

Installation accessories



**4630-3034
Track roller**

- Quiet low friction roller assembly
- Shoulder dimension "X" = 1/8" (3mm)



**4630-334
Switch End Cap**

- End cap (black powder coat finish only) with cut outs for installing on/off and hold open switches

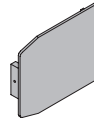

**4630-334-2
Blank End Cap**

- Black powder coat only

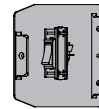

**4630-334CS
Switch End Cap**

- End cap and switch (black powder coat only) for concealed switch option

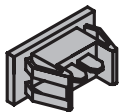

**4630-3179-1
On/Off Switch Assembly**

- Black rocker switch (plugs into high voltage PC board)

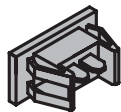

**4630-3179-2
Hold Open Switch Assembly**

- Black rocker switch
- Field wired to low voltage PC board

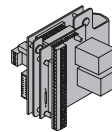

**4630-3180
PC Board Assembly**

- High and low voltage PC boards connected to mounting bracket



**4630-3454
Motor/Clutch Assembly**

- A geared assembly in an LCN automatic operator that incorporates a "no destruct" feature



**4630-3462
Control Box Assembly**

- Digital controller with built-in 12/24 VDC power supply
- Programming and timing functions are adjusted on controller



**4630-3498-1
Ribbon Cable Connector**

- 16 wire ribbon cable connecting PC board assembly to controller



**4630-3498-2
AC Power Cable**

- 2 wire cable to connect 120 VAC from PC board assembly to controller

Introduction
 Product selection guide
 Pneumatic systems
 Auto equalizers
 2610/4810/4820/4840/7900 Series
 Electrohydraulic systems
 Auto equalizers
 4630/4640 Series
 Electromechanical systems
 Benchmark
 9130/9140/9150 Series
 Electromechanical systems
 Senior Swing
 2810/2850/2860/9530/9540/9550/9560 Series
 Actuators and accessories

Ordering information

How-to-order 4630 Series operators

1. Select finish

- Standard powder coat _____
Aluminum (689), Dark Bronze (695),
Statuary Bronze (690), Light Bronze
(691), Black (693), Brass (696).

Operator will be shipped with:

- Standard cylinder
- Metal cover
- Standard arm
- Track roller
- Standard track
- Wood and machine screws
(unless options listed below are selected)

Operator options

Cylinder assembly

- Cast Iron Cylinder Assembly (CYL)
(concealed on/off switch)
(separate key switches suggested)

Finish

- Custom Powder Coat (RAL) _____
- Plated finish _____

Screw packs

- Through Bolt¹ Wood and Machine Screws (TBWMS)
- Torx Machine Screws (TORX)
- Through Bolt¹ and Torx Machine Screw (TBTRX)

Special template

- ST- _____

1. Specify door thickness if other than 1 3/4".

Table of sizes

- Non-Sized 4630 series cylinder is adjustable from size 1 through size 4 and is shipped set to size 3
- Closing power of 4630 Series closers may be increased 50%

Exterior (and vestibule) door width

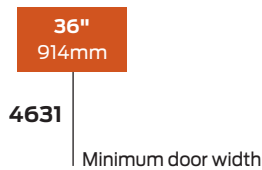

Interior door width



➔ Indicates recommended range of door width for operator.
Note: Minimum door width 36" (914mm).

4640 Series



The 4640 auto equalizer is LCN's smart and reliable electrically powered low-energy automatic operator. It provides easy access for people with disabilities, or the elderly. Designed primarily for manual opening applications that occasionally required automatic opening.

Features

Certifications	Grade 1 - ANSI A117.1, A156.19, UL 10C, ADA, 100 Hour Salt Spray, Meets BAA - Buy American Act	Cover	Metal Cover (MC)
Body construction	<ul style="list-style-type: none"> Cast iron body Full complement bearing 1 1/2" diameter piston 3/4" diameter double heat treated pinion journal 	Fasteners	Wood and Machine Screws (WMS)
Fluid	All weather fluid	Mounting	Top jamb (push side)
Handing	Non-handed	Arms	<ul style="list-style-type: none"> Regular Arm (REGARM), standard Long Arm (LONG), optional
Size	Adjustable spring size 2-5	Finishes/colors/ powder coat	<ul style="list-style-type: none"> 689 Aluminum 690 Statuary Bronze 691 Light Bronze 693 Black 695 Dark Bronze 696 Brass Custom colors optional Optional SRI primer - powder coat only Optional plated finishes*
Warranty	2 years		*End caps are black

Special templates | Customized installation templates or products may be available to solve non-standard applications. Contact LCN Product Support for assistance.

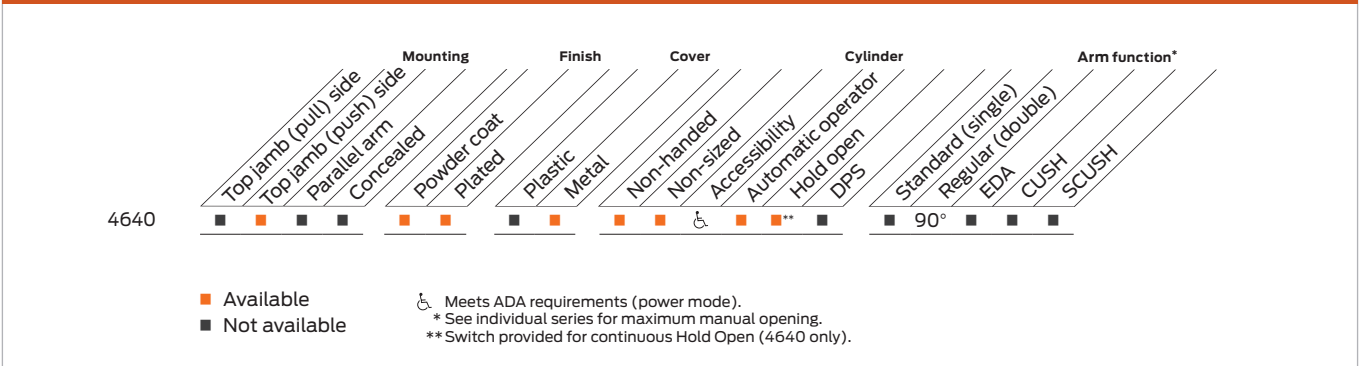

Introduction
 Product selection guide
 Pneumatic systems / Auto equalizers / 2610/4810/4820/4840/7900 Series
 Electrohydraulic systems / Auto equalizers / 4630/4640 Series
 Electromechanical systems / Benchmark / 9130/9140/9150 Series
 Electromechanical systems / Senior Swing / 2810/2850/2860/9530/9540/9550/9560 Series
 Actuators and accessories

Mounting details

Top jamb (push side) mounting

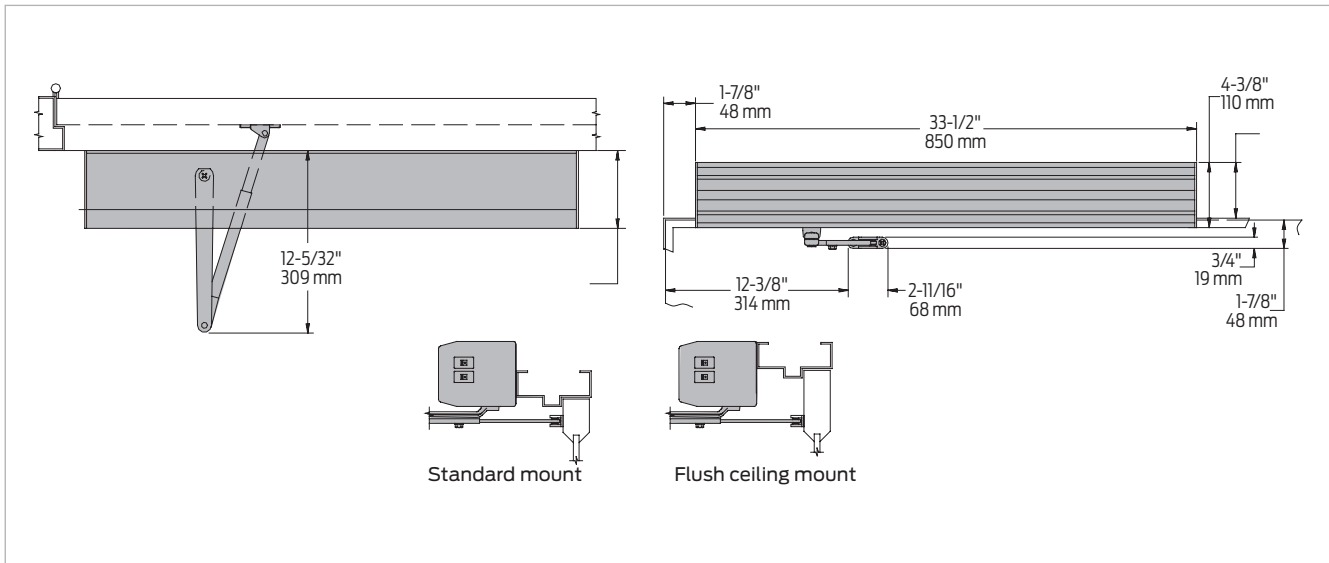

Butt hinges	Should not exceed 5" (127 mm) in width
Auxiliary stop	Recommended
Reveal	<ul style="list-style-type: none"> 4 1/2" (114 mm) allows up to 90° power opening and 100° manual opening 8" (203 mm) allows up to 90° power opening and 100° manual opening with long arm where standard rod and shoe is replaced with optional long rod and shoe, 4640-79LR
Top rail	<ul style="list-style-type: none"> Minimum 1 3/4" (44 mm) Flush ceiling installation requires 3 3/4" (95 mm) minimum
Head frame	Minimum 1 3/4" (44 mm) (the standard mounting plate is also used to meet flush ceiling conditions)
Opening time and force	<ul style="list-style-type: none"> Variable by adjustments to the electronic control module located on the operator assembly Maximum hold open time adjustable up to approximately five minutes
System diagram	See page 33 for typical system wiring and pages 34-35 for electrical data
Maximum opening	<ul style="list-style-type: none"> Templating allows 90° power opening and 100° manual opening Consult factory for all pivot mounted installations

Notes:

- Actuators are sold separately, see pages 100-117
- Comes with a digital control box utilizing a 4040XP heavy duty door closer with on-board diagnostics and power supply
- Has a factory default memory that include "No Destruct" drive system
- Guard rails or safety mats not required
- 4640 has easily accessible switches to provide on/off and continuous hold open functions
- CS options provides concealed on/off power switch
- Control module provides timing and sequential door functions, electric strike controls and adjustments for opening speed and force

Accessories

Cylinders



**4642-3971
Cast Iron Cylinder
Assembly (CYL)**

- Non-handed
- Standard



**4642-3071
Cast Iron Cylinder
Assembly (CYL)**

- Non-handed
- Mounting plate
- Includes; 4640-3454 Motor Clutch, 4640-3180 I/O Board Assembly and 4640-3462 Controller
- Standard



**4642-3071CS
Cast Iron Cylinder Assembly (CYL)**

- Non-handed
- Mounting plate
- Includes; 4640-3454 Motor Clutch, 4640-3180 I/O Board Assembly and 4640-3462 Controller
- Same as a 4640-3071 assembly except on/ off switch is concealed in endcap and no hold open switch is included (Separate key switches suggested)
- Optional

Covers

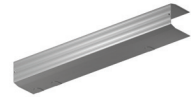

**4640-72MC
Metal Cover (MC)**

- Non-handed
- Standard

Arm



**4640-3077
Regular Arm (REGARM)**

- Non-handed



**4640-3077L
Long Arm (LONG)**

- Includes long rod and shoe, 4640-79LR for deep reveals



**4640-79
Rod and Shoe**

- For use with regular arm



**4640-79LR
Long Rod and Shoe**

- Used for long arm with deep reveals

Installation accessories



**4640-334
Switch End Cap**

- End cap (black powder finish coat only) with cut outs for installing on/off and hold open switches

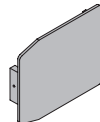

**4640-334-2
Blank End Cap**

- Black powder coat only

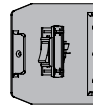

**4640-334CS
Switch End Cap**

- End cap and switch (black powder coat only) for concealed switch option



**4640-3179-1
On/Off Switch Assembly**

- Black rocker switch
- Plugs into high voltage PC board

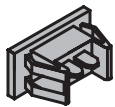

**4640-3179-2
Hold Open Switch Assembly**

- Black rocker switch
- Field wired to low voltage PC board

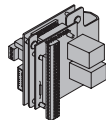

**4640-3180
PC Board Assembly**

- High and low voltage PC boards connected to mounting bracket



**4640-3454
Motor/Clutch Assembly**

- A geared assembly in an LCN automatic operator that incorporates a "no destruct" feature



**4640-3462
Control Box Assembly**

- Digital controller with built-in 12/24 VDC power supply
- Programming and timing functions are adjusted on controller



**4640-3498-1
Ribbon Cable Connector**

- 16 wire ribbon cable connecting PC board assembly to controller



**4640-3498-2
AC Power Cable**

- 2 wire cable to connect 120 VAC from PC board assembly to controller

Ordering information

How-to-order 4640 Series operators

1. Select finish

- Standard powder coat _____
Aluminum (689), Dark Bronze (695),
Statuary Bronze (690), Light Bronze
(691), Black (693), Brass (696).

Operator will be shipped with:

- Standard cylinder
- Metal cover
- Regular arm
- Wood and machine screws
(unless options listed below are selected)

Operator options

Cylinder assembly

- Cast Iron Cylinder Assembly (CYL)
(concealed on/off switch)
(separate key switches suggested)

Finish

- Custom Powder Coat (RAL) _____
- Plated finish _____

Screw packs

- Through Bolt¹ Wood and Machine Screws (TBWMS)
- Torx Machine Screws (TORX)
- Through Bolt¹ and Torx Machine Screw (TBTRX)

Special template

- ST- _____

1. Specify door thickness if other than 1 3/4".

Table of sizes

- Non-sized 4640 series cylinder is adjustable from size 2 through size 5 and is shipped set to size 3
- Closing power of 4640 Series closers may be increased 50%

Exterior (and vestibule) door width

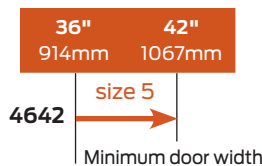

Interior door width

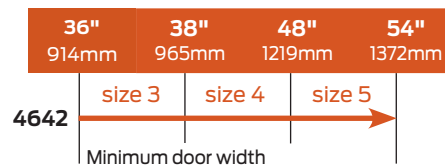

➔ Indicates recommended range of door width for operator.
Note: Minimum door width 36" (914mm).

Electromechanical automatic operators

LCN's electromechanical products are designed primarily for automatic opening applications that occasionally require manual opening. A control box provides all electrical functions. These self-contained units are suitable for use on single leaf doors or pair of doors. These products combine all the control and power elements into a single operator package, only some actuators are required to complete the system. Surface mounted and overhead concealed mountings available with two standard anodized finishes – Aluminum and Dark Bronze.

Low energy electromechanical automatic operators

- Complies with ANSI 156.19
- Opening time from full close to back check is no faster than 3 seconds
- Less than 15 lbs of force to open door manually

General electrical data

- The 115/240 volt power supply must be a dedicated circuit from the main circuit breaker panel and must not be connected into a building lighting system operating fluorescent lights.
- Location of conduits determined by mounting. See installation instructions for location.

2800/9500 Series electrical data

- 120 VAC 60Hz input @ 2.5 amps (2800 and 9500 Series).
- 240 VAC 50/60 Hz @ 2.5 amps (2800 and 9500 Series).
- 24 VDC output @ 1 amp (protected by self-resetting thermal fuse).

9100 Series electrical data

- 120 VAC input @ 1 amp.
- 24 VDC output @ 2.5 amps.

On-board power supply

Provides 24V DC output to power card readers, manual actuators and other peripherals.

Electronic circuit protection

Fused input circuit protection and fused output protection for 24 VDC peripherals.

Visual function indicators

There are 2 LED's for installation and trouble shooting feedback. The motor LED will illuminate when the motor drive circuit energizes. This is when the operator is activated it will remain on only during the opening of the door and the power LED this will illuminate when power is applied to the board and remains illuminated as long as there is power applied to the board.

Programming mode

Allows tailoring of the following functions to meet specific site conditions:

- Power boost
- Opening speed
- Back check speed
- Hold open time delay
- Back check position
- Closing speed
- Latch position
- Push 'N Go
- Delayed activation

Standards, listings and approvals

- UL listed for self-closing doors without hold open
- UL 325 tested and certified under ANSI
- Low Energy Electromechanical Operators ANSI 156.19.
- ADA Compliant
- Wiring is compliant with both UL 325 and the NEC. (separation of high)and low voltage)
- Consult the factory for other listings

Warranty

2 year limited warranty. See General Information catalog for complete details.

Maintenance

- For best performance, mount operators according to the LCN installation instructions
- Periodic visual inspections are recommended
- No service contracts

Wiring diagrams

This page illustrates examples of typical electric LCN systems. Please consult your local RSO representative or LCN for assistance with specific installations and material requirements.

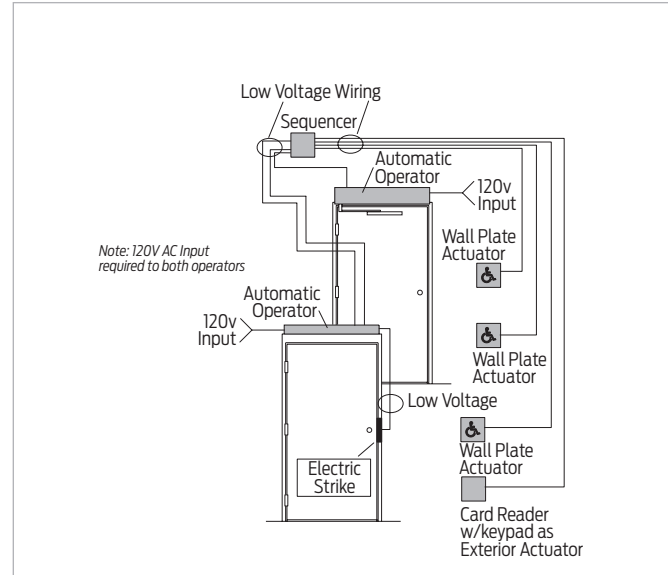
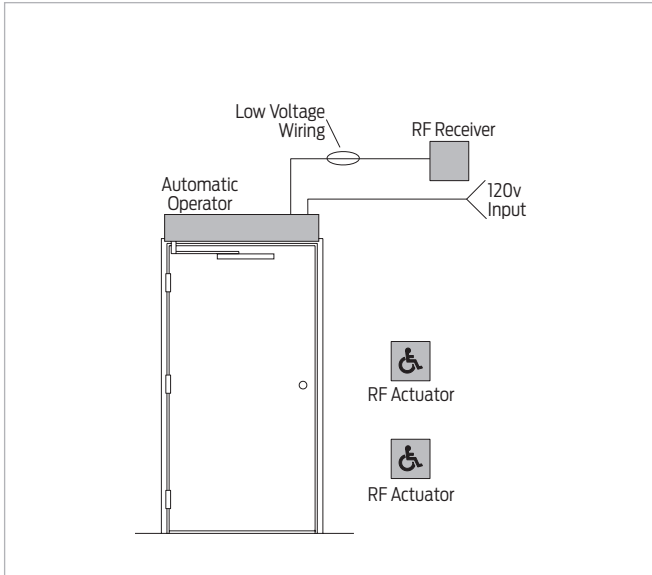

Single door system (wireless)

- An interior door
- Guide rails or safety devices not required
- Free swinging (or dogged) door

How it works

- Wireless actuators with receiver, powered by the transformer allows for easy installation
- For automatic door operation, touching either actuator signals the receiver and automatic operator to open the door to 90 degrees
- The door is held there until the system times out
- Door closes via spring return
- Door opening speed, closing speed and hold open time is adjustable on the control box
- If not actuated, the automatic operator functions as a manual door

Bill of materials

Qty	Part number	Description
1	9531	Auto operator (RH)
2	8310-3853WS	Wireless actuator, wall mount and surface, logo, 4 3/4" x 4 3/4"
1	8310-865	Wireless receiver

Vestibule door system (wired)

- Exterior and vestibule doors
- Sequential operation
- Guide rails or safety devices not required
- Controlled access, free egress

How it works

- This installation provides both accessibility and security for building occupants
- It allows for the integration of multiple automatic operators, a card reader and electric strike
- A sequencer allows sequential operation of the two automatic operators
- Vestibule actuators allow single door ingress/ egress from the vestibule as needed
- If not actuated the automatic operator functions as a manual door

Bill of materials

Qty	Part number	Description
1	9542	Auto operator (RH)
1	9531	Auto operator (RH)
3	8310-853	Hard wired wall mount, logo, 4 3/4" x 4 3/4"
1	8310-849	Sequencer
Other products from Von Duprin and Schlage Electronics		

Control box diagram

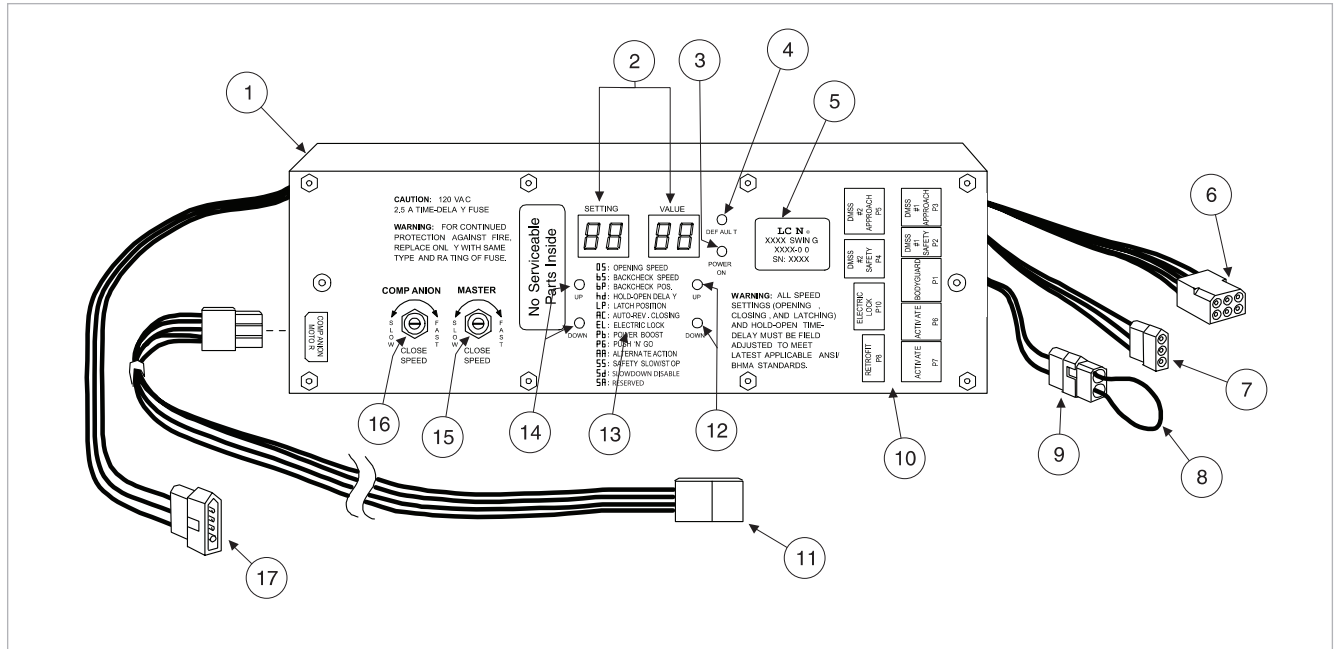

2800/9500 Series

1. Control box, 115VAC 60Hz, or 240 VAC 50/60 Hz
2. Seven segment display
3. Power indicator
4. Factory default push button
5. Model identification label
6. 6-pin connector for master motor
7. 3-pin connector for 3 position switch
8. Breakaway jumper cable
9. 2-pin connector for breakaway switch
10. Accessory direct connect diagram
11. 6-pin connector for companion motor (supply only w/simultaneous pairs)
12. Value adjustment push buttons
13. Setting adjustment menu
14. Function adjustment push buttons
15. Closing speed adjustment dial (master)
16. Closing speed adjustment dial (companion)
17. 3-pin connector for AC power

Introduction
 Product selection guide
 Pneumatic systems
 Auto equalizers
 2610/4810/4820/4840/7900 Series
 Electrohydraulic systems
 Auto equalizers
 4630/4640 Series
 Electromechanical systems
 Benchmark
 9130/9140/9150 Series
 Electromechanical systems
 Senior Swing
 2810/2850/2860/9530/9540/9550/9560 Series
 Actuators and accessories

Control box diagram

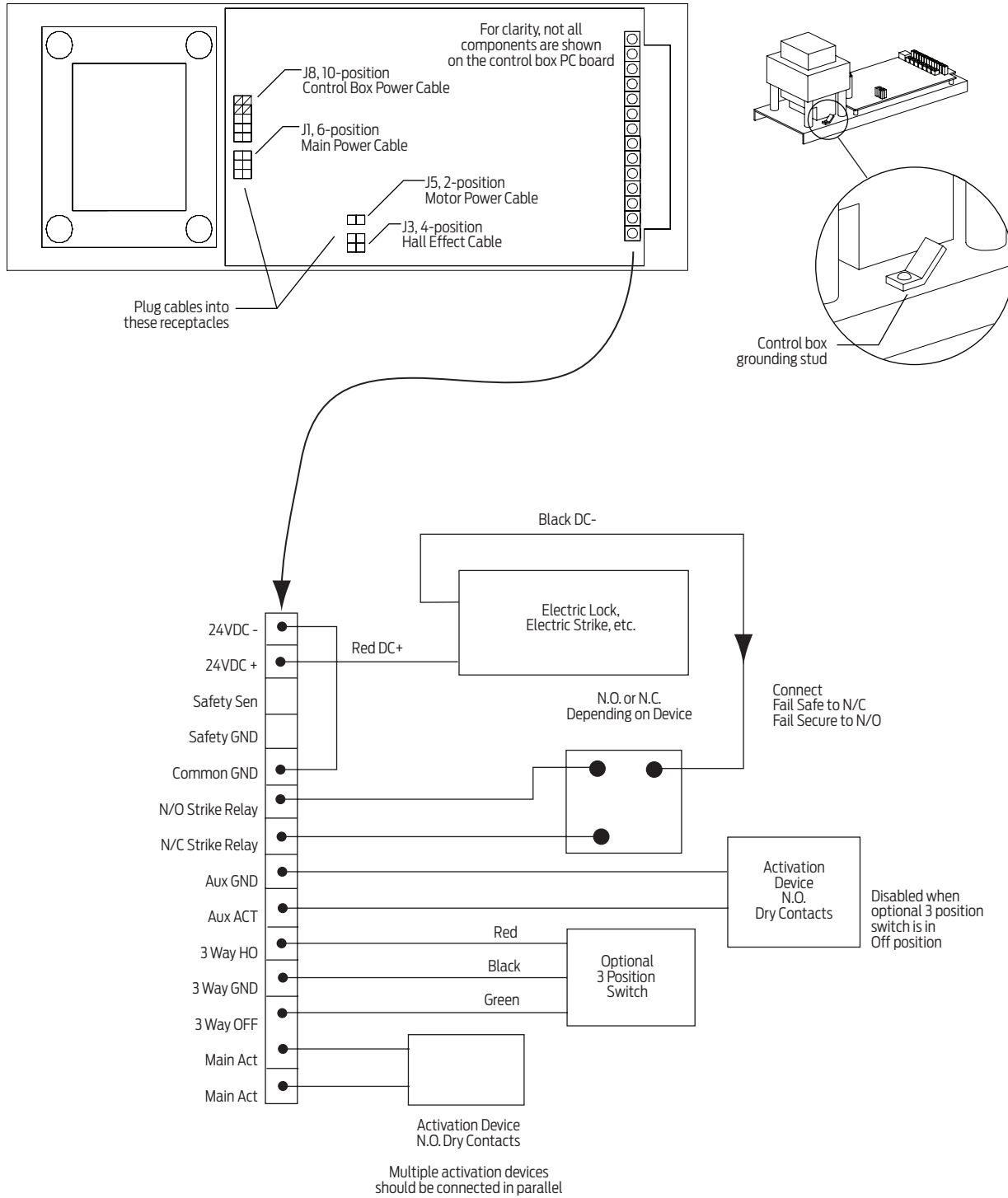

9130 Series

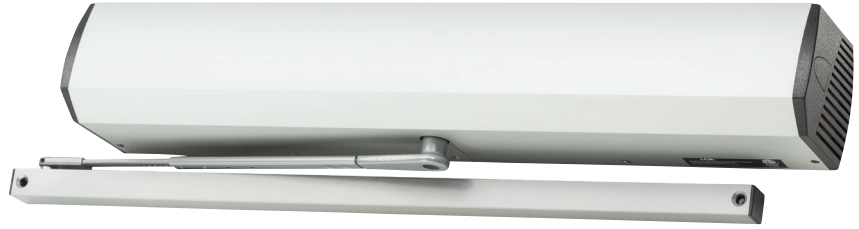

The 9130 Benchmark by LCN is an electrically powered low-energy operator. It provides easy access for people with disabilities, or the elderly. Designed primarily for automatic opening applications that occasionally require manual opening. The Benchmark is a cost-effective solution for retrofitting an activated or manual door.

Features

Certifications	Grade 1 - A156.19, UL325/228, ADA, 100 Hour Salt Spray, Meets BAA - Buy American Act	Cover	<ul style="list-style-type: none"> ▪ Metal 27", standard ▪ Metal 36", optional
Handing	Non-handed	Fasteners	Wood and Machine Screws (WMS)
Cover	<ul style="list-style-type: none"> ▪ 30" - 48" ▪ 30" minimum door width for 27" ▪ 36" door width only for full length pull operator 	Mounting	Single interior door, surface mount, offset pivot/butt hinge (pull side)
Warranty	2 years	Arms	Standard arm and track
		Finishes/colors/ powder coat	<ul style="list-style-type: none"> ▪ 628 Aluminum, Anodized ▪ 710 Dark Brown, Anodized

Special templates | Customized installation templates or products may be available to solve non-standard applications. Contact LCN Product Support for assistance.

Mounting	Handing	Finish	Cover	Arm function
Surface mount single door	Handed	Standard anodized	Standard (single lever)	Standard pivot arm
Surface mount simultaneous pair	Non-handed	Metal	Regular (double lever)	Offset pivot arm
Surface mount independent pair			Double egress (push/pull)	
Concealed single door				
Concealed simultaneous pair				
Concealed independent pair				

■ Available
■ Not available

Introduction
 Product selection guide
 Pneumatic systems / Auto equalizers / 2610/4810/4820/4840/7900 Series
 Electrohydraulic systems / Auto equalizers / 4630/4640 Series
 Electromechanical systems / Benchmark / 9130/9140/9150 Series
 Electromechanical systems / Senior Swing / 2810/2850/2860/9530/9540/9550/9560 Series
 Actuators and accessories

Mounting details

Top jamb (single door) mounting

Offset/butt hinge, center pivot, pull, standard cover

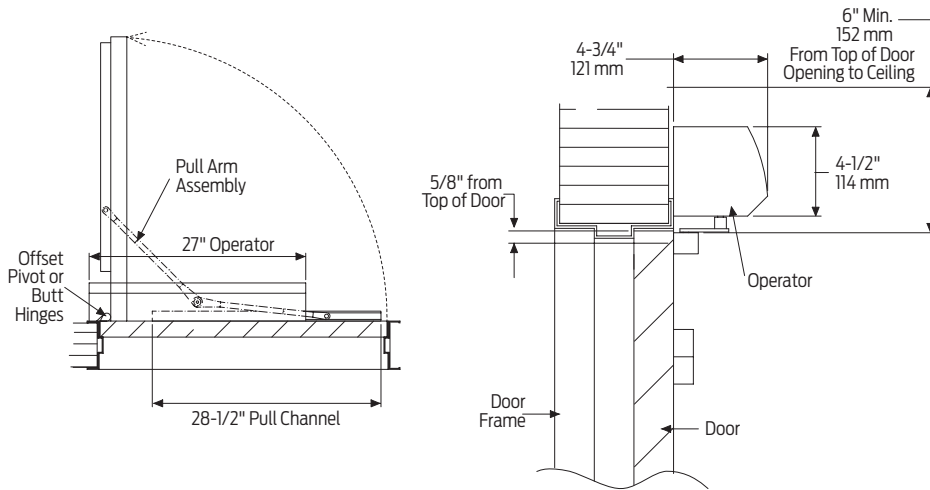

Offset/butt hinge, center pivot, pull, full cover

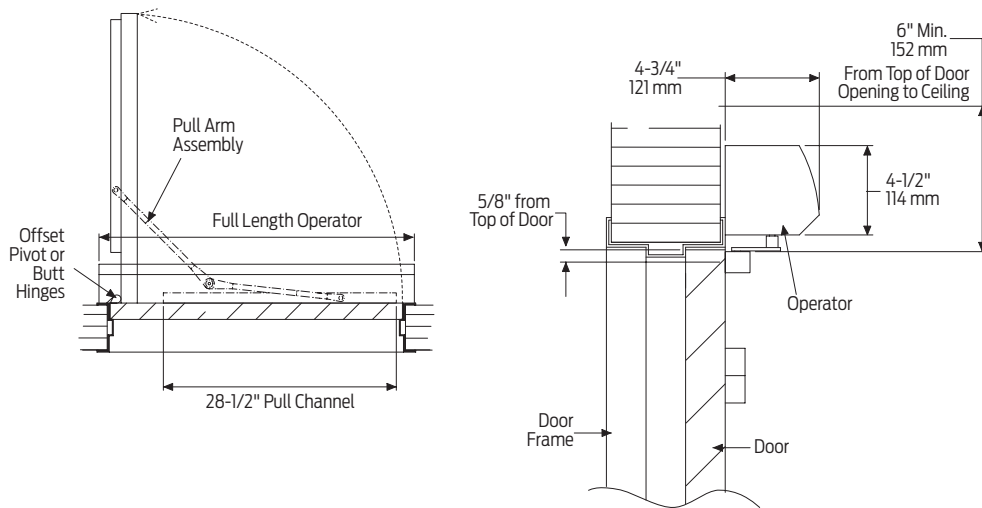

Butt hinges	Should not exceed 5" (127 mm) in width
Reveal	Should not exceed 1/8" (3 mm)
Top rail	Minimum 2" (51 mm)
Head frame	Minimum 2" (51 mm)
Opening and closing time	<ul style="list-style-type: none"> Variable by adjustments to the electronic control module located on the operator assembly Maximum hold open time adjustable up to approximately 30 seconds
System diagram	See page 45 for typical system wiring and page 44 for electrical data
Maximum opening	Template allows 90 degree power opening and 90 degree manual opening

Notes:

- Push 'N Go permits non-switch activation with a microprocessor control box that ensures reliability and maintains customer settings
- Power boost allows for increased closing force near latch
- On/off switch is included as standard
- All potentiometers are clearly labeled with their functions
- LED lights indicate power to control box and motor gearbox

Accessories

Motor gearbox



9130-3454S
Standard Motor Gearbox (MGB)

- Driving mechanism for operator (switch included)
- For 27" unit



9130-3454
Standard Motor Gearbox (MGB) (W/O Switch)

- Driving mechanism for operator (switch not included)
- For full length 36" unit

Control box

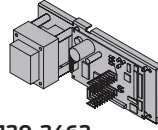

9130-3462
Standard Controller (120 volts) (CTRL)

- Electronic controlling device with power supply output and power boost feature

Arm



9130-3077T
Standard Arm (STDTRKARM)

- Non-handed
- Track roller not included



9130-3077PLCM
Standard Arm (STDTRKARM)

- Non-handed
- Standard non-handed track

Track



9130-3038
Standard Track (STDTRK)

- Non-handed
- Standard



9130-73
Track End Cap

- Black plastic

Installation accessories



9130-3034
Roller assembly

- Quiet low friction

Brackets



9130-3018
Mounting Bracket

- Standard

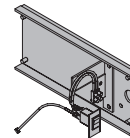

9130-3351-2
Switch bracket

- 41" cable
- Bracket used to locate switch at end of cover on full length unit

Covers

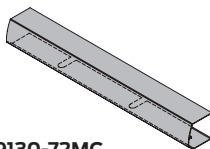

9130-72MC
Standard 27" Metal Cover (MC27)

- Non-handed
- 27"
- Extruded aluminum
- Standard

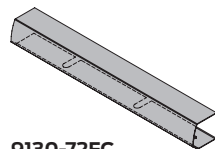

9130-72FC
Full Metal Cover 36" (FMC)

- Non-handed
- 36"
- Extruded aluminum

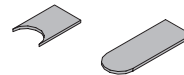

9130-163
Cover Insert

- Used to cover operator shaft opening (includes 2 pieces)

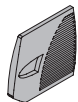

9130-163-1
Cover End Cap Insert

- Used to cover switch hole opening



9130-334
Cover End Cap

- Black plastic
- Includes 9130-163-1 cover and cap insert

Introduction
 Product selection guide
 Pneumatic systems
 Auto equalizers
 2610/4810/4820/4840/7900 Series
 Electrohydraulic systems
 Auto equalizers
 4630/4640 Series
 Electromechanical systems
 Benchmark
 9130/9140/9150 Series
 Electromechanical systems
 Senior Swing
 2810/2850/2860/9530/9540/9550/9560 Series
 Actuators and accessories

Ordering information

How-to-order 9130 Series operators

1. Select finish

- Standard anodized finish _____
Aluminum, Clear Anodized (628) or
Dark Brown, Anodized (710).

Operator will be shipped with:

- Standard motor gearbox
- Standard control box
- Mounting bracket
- 27" metal cover
- Standard arm (3077t)
- Standard track w/track roller
- Wood and machine screws
(unless options listed below are selected)

Operator options

Cover

- Full Metal Cover 36" (FMC)

Table of sizes

Door width



Indicates recommended range of door width for operator.

Note: For all Benchmark series. 30" minimum door width for 27" pull operator. 36" door width only for full length pull operator.

9140 Series



The 9140 Benchmark by LCN is an electrically powered low-energy operator. It provides easy access for people with disabilities, or the elderly. Designed primarily for automatic opening applications that occasionally require manual opening. The Benchmark is a cost-effective solution for retrofitting an activated or manual door.

Features

Certifications	Grade 1 - A156.19, UL325/228, ADA, 100 Hour Salt Spray, Meets BAA - Buy American Act	Fasteners	Wood and Machine Screws (WMS)
Handing	Non-handed	Mounting	Single interior door, surface mount, offset pivot/butt hinge (push side)
Door width	<ul style="list-style-type: none"> 26" - 48" 26" minimum door width for 27" 36" door width only for full length pull operator 	Arms	Regular Arm (REGARM)
Warranty	2 years	Finishes/colors/powder coat	<ul style="list-style-type: none"> 628 Aluminum, Anodized 710 Dark Brown, Anodized

Special templates | Customized installation templates or products may be available to solve non-standard applications. Contact LCN Product Support for assistance.

Mounting	Handing	Finish	Cover	Arm function
Surface mount single door	Handed	Standard anodized	Standard (single lever)	Offset pivot arm
Surface mount simultaneous pair	Non-handed	Metal	Regular (double lever)	Center pivot arm
Surface mount independent pair			Double egress (push/pull)	
Concealed single door				
Concealed simultaneous pair				
Concealed independent pair				

■ Available
■ Not available

Introduction
 Product selection guide
 Pneumatic systems / Auto equalizers / 2610/4810/4820/4840/7900 Series
 Electrohydraulic systems / Auto equalizers / 4630/4640 Series
 Electromechanical systems / Benchmark / 9130/9140/9150 Series
 Electromechanical systems / Senior Swing / 2810/2850/2860/9530/9540/9550/9560 Series
 Actuators and accessories

Mounting details

Top jamb (single door) mounting

Offset/butt hinge, center pivot, push, standard cover

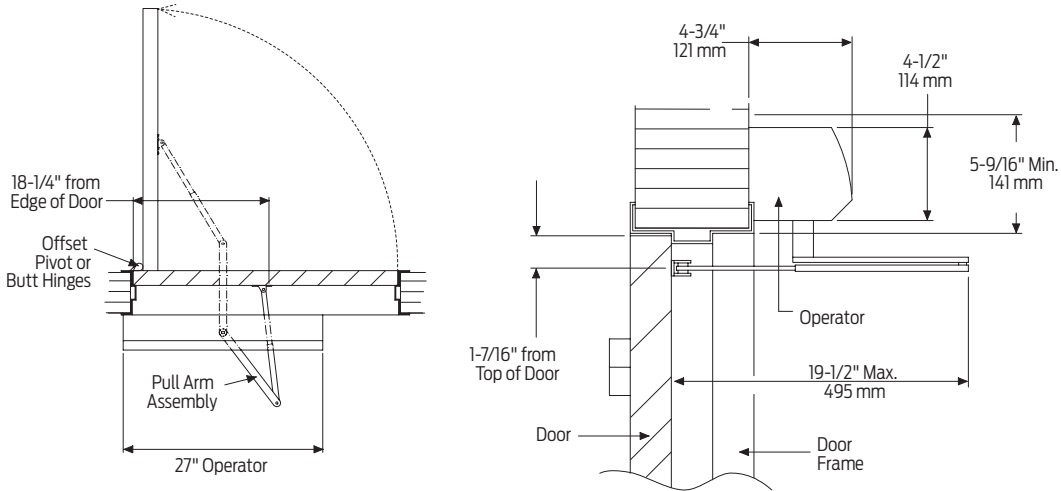

Offset/butt hinge, center pivot, push, full cover

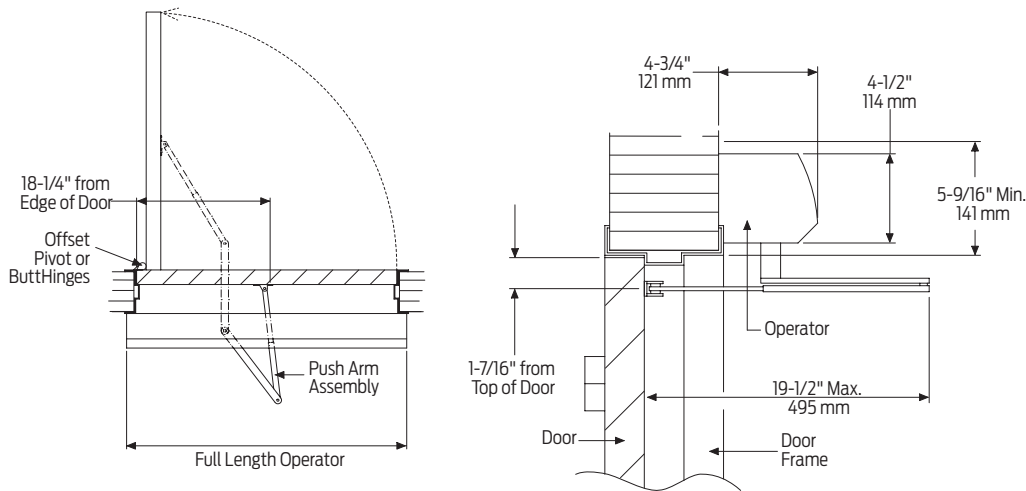

Butt hinges	Should not exceed 5" (127 mm) in width
Reveal	Push installations should not exceed 6" (152 mm) for regular arm and 9 3/4" (248 mm) for long arm
Top rail	<ul style="list-style-type: none"> Minimum 2" (51 mm) Flush ceiling installation requires 5 1/4" (133 mm) minimum
Head frame	Minimum 2" (51 mm)
Opening and closing time	<ul style="list-style-type: none"> Variable by adjustments to the electronic control module located on the operator assembly Maximum hold open time adjustable up to approximately 30 seconds
System diagram	See page 45 for typical system wiring and page 44 for electrical data
Maximum opening	Template allows 90 degree power opening and 90 degree manual opening

Notes:

- Push 'N Go permits non-switch activation with a microprocessor control box that ensures reliability and maintains customer settings
- Power boost allows for increased closing force near latch
- On/off switch is included as standard
- All potentiometers are clearly labeled with their functions
- LED lights indicate power to control box and motor gearbox

Accessories

Motor gearbox



**9140-3454S
Standard Motor Gearbox
(MGB)**

- Driving mechanism for operator (switch included)
- For 27" unit



**9140-3454
Standard Motor Gearbox
(MGB) (W/O Switch)**

- Driving mechanism for operator (switch not included)
- For full length unit (36")

Control box

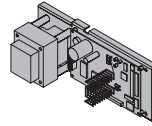

**9140-3462
Standard Controller (120 volts)
(CTRL)**

- Electronic controlling device with power supply output and power boost feature

Arm



**9140-3077
Regular Arm (REGARM)**

- Non-handed



**9140-3077L
Long Arm (LONG)**

- Non-handed



**9140-79
Rod and shoe**

- For use with regular arm



**9140-79LR
Long rod and shoe**

- Used with long arm, for deep reveals

Brackets



**9140-3018
Mounting Bracket**

- Standard

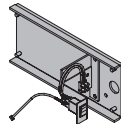

**9140-3351-1
Switch bracket**

- 29" cable
- Used with a 36" door
- Used to locate switch at end of cover on full length unit

Covers

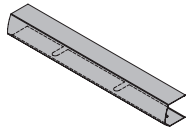

**9140-72MC
Standard 27" Metal Cover (MC27)**

- Non-handed
- 27"
- Extruded aluminum cover
- Standard

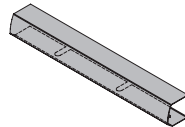

**9140-72FC
Full 36" Cover (FC36)**

- Non-handed
- 36"
- Extruded aluminum cover

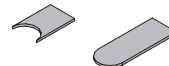

**9140-163
Cover Insert**

- Used to cover operator shaft opening (includes 2 pieces)



**9140-163-1
Cover End Cap Insert**

- Used to cover switch hole opening



**9140-334
Cover End Cap**

- Black plastic
- Includes 9130-163-1 cover and cap insert

Ordering information

How-to-order 9140 Series operators

1. Select finish

- Standard anodized finish _____
Aluminum, Clear Anodized (628) or
Dark Brown, Anodized (710).

Operator will be shipped with:

- Standard motor gearbox
- Standard control box
- Mounting bracket
- 27" metal cover
- Standard arm (3077t)
- Standard track w/track roller
- Wood and machine screws
(unless options listed below are selected)

Operator options

Cover

- Full Metal Cover 36" (FMC)

Arm

- Long Arm (LONG) (reveals 6" to 9 3/4")

Table of sizes

Door width



Indicates recommended range of door width for operator.

Note: For all Benchmark series. 30" minimum door width for 27" pull operator. 36" door width only for full length pull operator.

9150 Series



The 9150 Benchmark by LCN is an electrically powered low-energy operator. It provides easy access for people with disabilities, or the elderly. Designed primarily for automatic opening applications that occasionally require manual opening. The Benchmark is a cost-effective solution for retrofitting an activated or manual door.

Features

Certifications	Grade 1 - ANSI A156.19, UL325/228, ADA, 100 Hour Salt Spray, Meets BAA - Buy American Act	Cover	Metal Cover (MC)
Handing	Non-handed	Fasteners	Wood and Machine Screws (WMS)
Templating	Peel-n-Stick templates - 2 3/8" x 6 3/4" mounting hole pattern	Mounting	Pair of doors, surface mount, offset pivot/butt hinges (push side)
Door width	<ul style="list-style-type: none"> Minimum door width 52" - 96" 72" door width only for full length double operator 	Arms	Regular Arm (REGARM)
Warranty	2 years	Finishes/colors/powder coat	<ul style="list-style-type: none"> 628 Aluminum, Anodized 710 Dark Brown, Anodized

Special templates | Customized installation templates or products may be available to solve non-standard applications. Contact LCN Product Support for assistance.

Mounting	Handing	Finish	Cover	Arm function
Surface mount single door	Handed	Standard anodized	Standard (single lever)	Offset pivot arm
Surface mount simultaneous pair	Non-handed	Metal	Regular (double lever)	Center pivot arm
Surface mount independent pair			Double egress (push/pull)	
Concealed single door				
Concealed simultaneous pair				
Concealed independent pair				

■ Available
■ Not available

Introduction
 Product selection guide
 Pneumatic systems / Auto equalizers / 2610/4810/4820/4840/7900 Series
 Electrohydraulic systems / Auto equalizers / 4630/4640 Series
 Electromechanical systems / Benchmark / 9130/9140/9150 Series
 Electromechanical systems / Senior Swing / 2810/2850/2860/9530/9540/9550/9560 Series
 Actuators and accessories

Mounting details

Top jamb, independent/simultaneous pair mounting

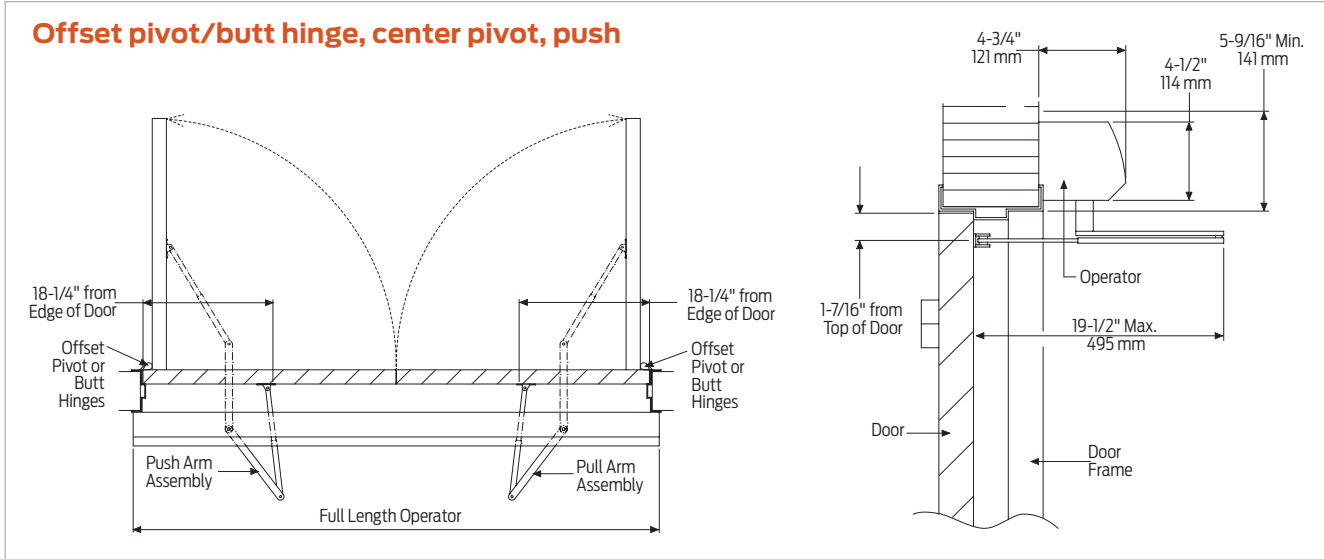

Butt hinges	Should not exceed 5" (127 mm) in width
Reveal	Push installations should not exceed 6" (152 mm) for regular arm and 9 3/4" (248 mm) for long arm
Top rail	<ul style="list-style-type: none"> Minimum 2" (51 mm) Flush ceiling installation requires 5 1/4" (133 mm) minimum
Head frame	Minimum 2" (51 mm)
Opening and closing time	<ul style="list-style-type: none"> Variable by adjustments to the electronic control module located on the operator assembly Maximum hold open time adjustable up to approximately 32 seconds
System diagram	See pages 45 for typical system wiring and page 44 for electrical data
Maximum opening	Template allows 90 degree power opening and 90 degree manual opening

Notes:

- Determined by wiring
- Push N' Go permits non-switch activation with a microprocessor control box that ensures reliability and maintains customer settings
- Power boost allows for increased closing force near latch
- All potentiometers clearly labeled with their functions
- LED lights indicate power to control box and motor gearbox

Accessories

Motor gearbox



9150-3454S
Standard Motor Gearbox (MGB)

- Driving mechanism for operator (switch included)

Control box

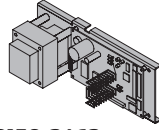

9150-3462
Standard Controller (120 volts) (CTRL)

- Electronic controlling device with power supply output and power boost feature

Arm



9150-3077
Regular Arm (REGARM)

- Non-handed



9150-3077L
Long Arm (LONG)

- Non-handed



9150-79
Rod and shoe

- For use with regular arm



9150-79LR
Long rod and shoe

- Used with long arm, for deep reveals

Brackets



9150-3018
Mounting Bracket

- Standard

Covers

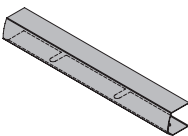

9150-72MC
Standard 72" Metal Cover (MC72)

- Non-handed
- 72"
- Extruded aluminum cover
- Standard

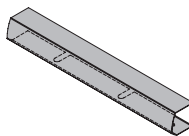

9150-163
Cover Insert

- Used to cover operator shaft opening (includes 2 pieces)



9150-163-1
Cover End Cap Insert

- Used to cover switch hole opening



9150-334
Cover End Cap

- Black plastic
- Includes 9130-163-1 cover and cap insert

Ordering information

How-to-order 9150 Series operators

1. Select finish

- Standard anodized finish _____
Aluminum, Clear Anodized (628) or
Dark Brown, Anodized (710).

Operator will be shipped with:

- Standard motor gearbox (2 ea)
- Standard control box (2 ea)
- Mounting bracket (2 ea)
- 27" metal cover
- Standard arm (2 ea)
- Wood and machine screws
(unless options listed below are selected)

Operator options

Arm

- Long Arm (LONG) (reveals 6" to 9 3/4")

Table of sizes

Notes: For 9150 Benchmark series. 72" door width only for full length push double door operator.

Senior Swing unique features

Digital control suite

Provides precise control of a range of built-in functions. Visual indications and digital readouts of all control function settings and activity make adjustments easy, fast and accurate.

Dual independent program memories

Each unit is pre-programmed to factory default settings. The installer can adjust the unit to meet the job site requirements. These field settings are locked into the computer's memory. Any subsequent field adjustments replace the original field adjustments. The factory settings are always retained in memory and can be recalled to replace the field settings in just seconds, restoring the unit to its original programming.

On-board diagnostics

Sophisticated built-in diagnostics program monitors the system microprocessor, power supplies, drive systems, actuators and safety circuits. Simplifying the process of verifying a correct and complete installation.

On-board power supply

Provides 24VDC to power card readers, manual actuators and other peripherals.

Plug and play sensors

Motion sensors and safety sensors feature a "plug and play" concept allowing fast and accurate wiring connections in only seconds.

Electronic circuit protection

High voltage (primary AC input) is protected by replaceable fuse. Low voltage is protected by self-resetting fuses.

Visual function indicators

LED Display allows direct observation of these inputs while in visual function indicator mode:

- Key switch - set to Auto, OFF or HOLD
- Activate
- DMSS approach
- DMSS safety
- Bodyguard
- Power Boost Disable

Programming mode

Allows tailoring of the following functions to meet specific site conditions:

- Opening speed
- Back check speed
- Back check position
- Hold open delay
- Latch position
- Auto reverse - closing
- Electric lock delay
- Power boost
- Push 'N' Go
- Alternate action
- Safety slow/stop
- Slow down disable

Push 'N Go

Allows pedestrians to walk up to the door and push it open as if it were a manual door. After the door is manually opened approximately 5 degrees, the Push 'N Go feature takes over and continues to open the door – slowly and automatically to the full open position. With Push 'N Go, the door will stay fully open from one to 30 seconds, depending on the time delay chosen.

Auto reverse

A safety feature that reverses the direction of the door when it comes into contact with an object during either opening or closing.

Safety slow/stops function

Once the door starts opening, any person or object entering the swing area will cause the door to go into a safety slow speed. This function can be set to allow for a short stop once a person or object is sensed.

Power boost

Adds an additional latching force to ensure secure latching in severe wind or stack conditions. Power Boost is also ideal for overcoming slowing obstacles such as electric strikes.

Microprocessor

Control unit allows for quiet efficiency in operation. Combined with the all electromechanical unit, it eliminates unnecessary wear and prolongs the life of the unit.

Electric lock delay

Causes a 1 second delay between activate signal and door opening to allow time for most electric locks to disengage before operator opens door.

2810 Series



The 2810 Senior Swing by LCN is an ADA door operator that is a two-in-one swing door operator. Senior swing operator when activated, opens doors automatically for wheelchair access, yet allows for manual operation for regular pedestrian traffic.

Features

Certifications	Grade 1 - ANSI A156.19, UL325, UL1998, ADA, 100 Hour Salt Spray, Meets BAA - Buy American Act	Fasteners	Wood and Machine Screws (WMS)
Handing	Handed	Mounting	Single door, overhead concealed, center pivot, offset pivot, butt hinge
Door width	Minimum door width 33" - 48"; 49" with finger guard <small>Note: Single door width per leaf 33" minimum, 48" maximum.</small>	Arms	Center pivot arm or offset pivot arm
Warranty	2 years	Finishes/colors/ powder coat	<ul style="list-style-type: none"> ▪ 628 Aluminum, Anodized ▪ 710 Dark Brown, Anodized

Special templates | Customized installation templates or products may be available to solve non-standard applications. Contact LCN Product Support for assistance.

Mounting	Handing	Finish	Cover	Arm function
Surface mount single door	Handed	Standard anodized	Standard (single lever)	Center pivot arm
Surface mount simultaneous pair	Non-handed	Metal	Regular (double lever)	Offset pivot arm
Surface mount independent pair			Double egress (push/pull)	
Concealed single door				
Concealed simultaneous pair				
Concealed independent pair				

■ Available
■ Not available

Introduction
 Product selection guide
 Pneumatic systems
 Auto equalizers
 2610/4810/4820/4840/7900 Series
 Electrohydraulic systems
 Auto equalizers
 4630/4640 Series
 Electromechanical systems
 Benchmark
 9130/9140/9150 Series
 Electromechanical systems
 Senior Swing
 2810/2850/2860/9530/9540/9550/9560 Series
 Actuators and accessories

Mounting details

Concealed single door mounting

Center pivot, breakaway stop, pull

Shown with 3 3/4" pivot and finger guard

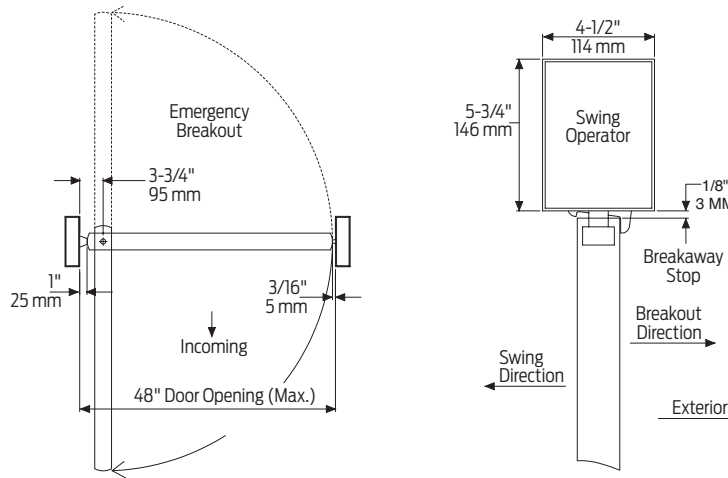

Center pivot, positive stop, push

Shown with 3 3/4" pivot and finger guard

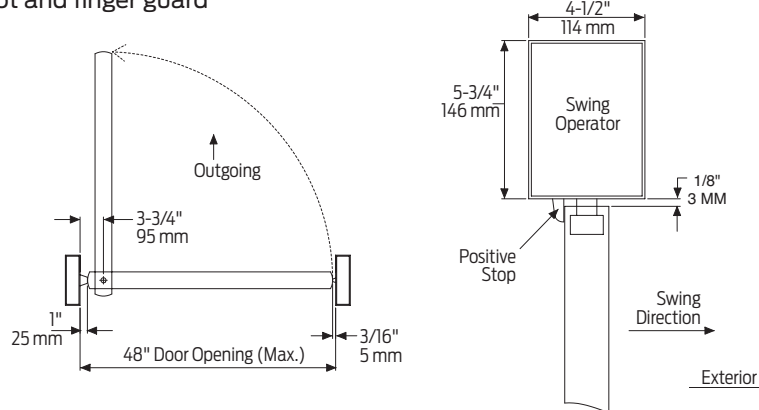

Top rail	Minimum 2" (51 mm)
Head frame	Minimum 36" (L) x 5 3/4" (H) x 4 1/2" (W) (914 mm x 146 mm x 114 mm)
Opening and closing time	<ul style="list-style-type: none"> Variable by adjustments to the electronic control box Maximum hold open time adjustable up to approximately 32 seconds
System diagram	See pages 45 for typical system wiring and page 44 for electrical data
Maximum opening	Template allows 90 degree power opening and 90 degree manual opening
Minimum header length	33" with applied stop by others and 36" with LCN positive or breakaway stop

Notes:

- Push N' Go permits non-switch activation
- Power boost provides additional latch forcing for electromechanical unit with microprocessor control
- Double Door Header available up to 98", specify length 49" to 98" maximum (consult factory regarding this option)
- Positive or breakaway stop available with center pivot arm
- Adjustable hold open time of 1-32 seconds

Mounting details

Concealed single door mounting

Offset pivot or butt hinge, slide arm, push

Shown with 3 3/4" pivot

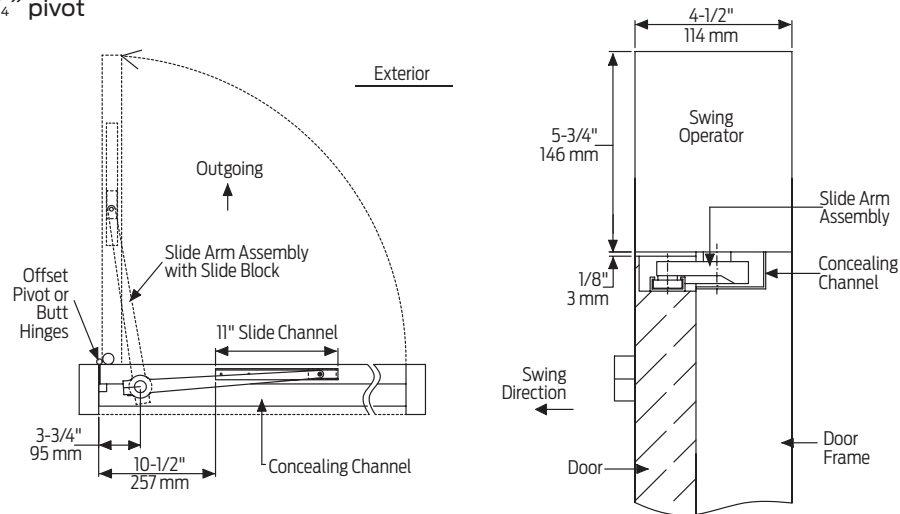

Top rail	Minimum 2" (51 mm)
Head frame	Minimum 33" (L) x 5-3/4" (H) x 4-1/2" (W) (838 mm x 146 mm x 114 mm)
Opening and closing time	<ul style="list-style-type: none"> Variable by adjustments to the electronic control box Maximum hold open time adjustable up to approximately 32 seconds
System diagram	See pages 45 for typical system wiring and page 44 for electrical data
Maximum opening	Template allows 90 degree power opening and 90 degree manual opening
	<ul style="list-style-type: none"> Minimum header length 33" Installations require bottom pivot and two intermediate pivots

Notes:

- Push N' Go permits non-switch activation
- Power boost provides additional latch forcing for electromechanical unit with microprocessor control
- Double door header available up to 98", specify length 49" to 98" maximum (consult factory regarding this option)
- Positive or breakaway stop available with center pivot arm
- Adjustable hold open time of 1-32 seconds

Introduction
 Product selection guide
 Pneumatic systems Auto equalizers 2610/4810/4820/4840/7900 Series
 Electrohydraulic systems Auto equalizers 4630/4640 Series
 Electromechanical systems Benchmark 9130/9140/9150 Series
 Electromechanical systems Senior Swing 2810/2850/2860/9530/9540/9550/9560 Series
 Actuators and accessories

Accessories

Motor gearbox



**2810-3454
Standard Motor Gearbox (MGB)**

- Senior Swing
- Handed
- Driving mechanism for operator
- Provides maximum 15 lbs opening force

Control box

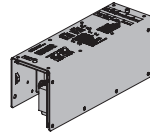

**2810-3462
Standard Controller (CTRL)**

- Senior Swing
- Electronic controlling device for Senior Swing

Arm



**2810-3077CP
2 3/4" Center Pivot Arm (ARMCP)**

- Center pivot installations only
- Used with overhead concealed operators and center pivoted doors



**2810-3077OP
3 3/4" Offset Pivot Arm (ARMOP)**

- Offset pivot or butt hung installations only
- Used with overhead concealed operators

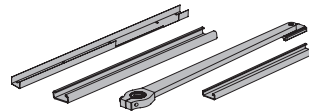

**2810-3077OPCM
Offset Pivot Arm Assembly**

- Offset arm with track and concealing channel (includes 3072 concealing channel, 168 slide channel and 3077OP offset pivot arm)

Brackets



**2810-375
Mounting Bracket**

- Motor gearbox mounting bracket for 3 3/4" offset pivot, butt hinge or center pivot with finger guard installations
- Front bracket



**2810-275
Mounting Bracket**

- Motor gearbox mounting bracket for 2 3/4" center pivot installations
- Front bracket



**2810-3018
Rear Mounting Bracket**

- Motor gearbox mounting bracket
- Rear bracket

Header

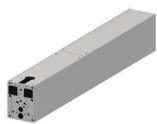

**2810-3572HL
Standard Mounting Header (HDR)**

- Standard
- Single door, single operator
- Specify length 33" to 49" maximum

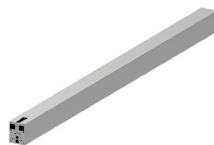

**2810-3572DD
Double Door Header (HDR2)**

- Standard
- Double door, single operator
- Specify length 49" to 98" maximum

End cap



**2810-334
Header End Caps**

- With openings for wiring

Accessories

Channels

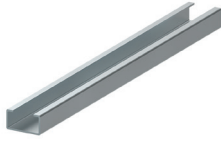

2810-3072

Concealing Channel

- Offset arm with track and concealing channel (includes 3072 concealing channel, 168 slide channel and 3077OP offset pivot arm) Used to conceal arm in overhead concealed applications
- For offset pivot installations only
- If ordering separately specify length and hand

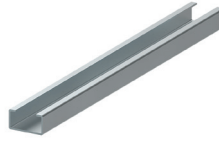

2810-168

Slide Channel

- Offset pivot or butt hinge installations only
- Mounts in top rail of door
- Allows arm to slide

Pivots

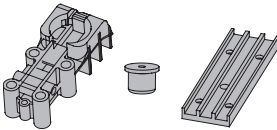

2810-3107

Bottom Pivot Assembly

- Includes pivot body, pivot post and bottom pivot plate
- For overhead concealed, center pivoted installations
- Includes; 2810-107, 2810-110 and 2810-117

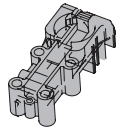

2810-107

Bottom Pivot Body

- For center pivoted installations



2810-110

Pivot Post

- Connects pivot body to bottom pivot plate for center pivoted installations

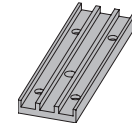

2810-117

Bottom Pivot Plate

- Applied to floor for center pivoted installations

Installation accessories

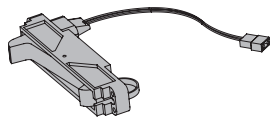

2810-384B

Breakaway Stop (BKY)

- Allows in-swinging door to swing out in case of emergency
- Disables operator in breakaway mode
- For center pivoted installations only



2810-384F

Positive Stop (POS)

- Prevents out-swinging door from swinging in
- For center pivoted installations only



2810-12

Filler Plate Blank

- Completes length of header box



2810-11A

Spindle Plate

- Hides bottom of motor gearbox
- Completes header box
- Cutout allows for motor gearbox shaft
- For 2 3/4" center pivot installations



2810-11B

Spindle Plate

- Hides bottom of motor gearbox
- Completes header box
- Cutout allows for motor gearbox shaft
- For 3 3/4" offset pivot, butt hinge or center pivot with finger guard installations

Ordering information

How-to-order 2810 Series operators

1. Select installation type

- 2811

2. Specify arm

- 3 3/4" Offset Pivot Arm (ARMOP)
- 2 3/4" Center Pivot Arm (ARMCP)

3. Specify hand

- Right hand (RH)
- Left hand (LH)

4. Specify header/length

- Standard Mounting Header (HDR) (Specify length 33" to 49" offset pivot)
- Standard Mounting Header (HDR) (Specify length 36" to 49" center pivot)
- Double Door Header (HDR2) (Specify length 49" to 98")

5. Select finish

- Standard anodized finish _____ Aluminum, Clear Anodized (628) or Dark Brown, Anodized (710).

Operator will be shipped with:

- Standard motor gearbox
- Standard control box
- Header (at specified length, 36" standard)
- Wood and machine screws (unless options listed below are selected)

Operator options

Stops

- Positive Stop (POS)
- Breakaway Stop (BKY)

Note: Available with Center Pivoted installations only.

Table of sizes

Door width



Indicates recommended range of door width for operator.

Note: For all Senior Swing Series. Single door - width per leaf 33" minimum, 48" maximum.

2850 Series



The 2850 Senior Swing by LCN is an ADA door operator that is a two-in-one swing door operator. Senior swing operator when activated, opens doors automatically for wheelchair access, yet allows for manual operation for regular pedestrian traffic.

Features

Certifications	Grade 1 - ANSI A156.19, UL325, UL1998, ADA, 100 Hour Salt Spray, Meets BAA - Buy American Act	Fasteners	Wood and Machine Screws (WMS)
Fluid	All Weather Fluid	Mounting	Double door, overhead concealed, center pivot, offset pivot, butt hinge
Handing	Handed	Arms	Offset Pivot Arm or Center Pivot Arm
Door width	<ul style="list-style-type: none"> Combined width min 52" - 96" Simultaneous pair - width per leaf 26" minimum to 48" maximum 	Finishes/colors/powder coat	<ul style="list-style-type: none"> 628 Aluminum, Anodized 710 Dark Brown, Anodized
Warranty	2 years		

Special templates | Customized installation templates or products may be available to solve non-standard applications. Contact LCN Product Support for assistance.

Mounting	Handing	Finish	Cover	Arm function
Surface mount single door	Handed*	Standard anodized	Standard (single lever)	Standard (single lever)
Surface mount simultaneous pair	Non-handed	Metal	Regular (double lever)	Double egress (push/pull)
Surface mount independent pair			Offset egress (push/pull)	Offset pivot arm
Concealed single door			Center pivot arm	
Concealed simultaneous pair				
Concealed independent pair				

■ Available
■ Not available

* Handed for 2850 and 2860, double egress only.

Introduction
 Product selection guide
 Pneumatic systems / Auto equalizers / 2610/4810/4820/4840/7900 Series
 Electrohydraulic systems / Auto equalizers / 4630/4640 Series
 Electromechanical systems / Benchmark / 9130/9140/9150 Series
 Electromechanical systems / Senior Swing / 2810/2850/2860/9530/9540/9550/9560 Series
 Actuators and accessories

Mounting details

Concealed simultaneous pair

Center pivot, breakaway stop, pull

Shown with 3 3/4" pivot

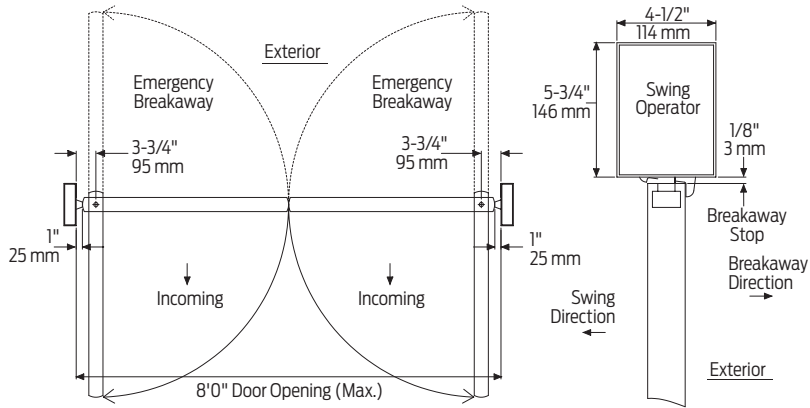

Center pivot, positive stop, push

Shown with 3 3/4" pivot

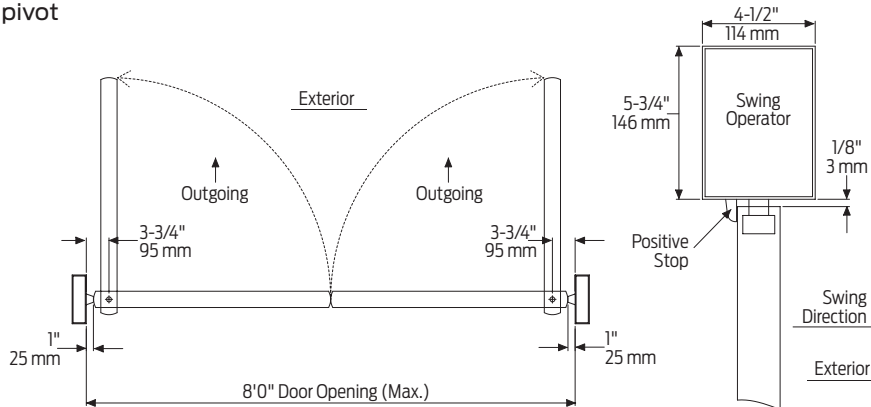

Top rail	Minimum 2" (51 mm)
Head frame	Minimum 52" (L) x 5 3/4" (H) x 4 1/2" (W) (1524 mm x 146 mm x 114 mm)
Opening and closing time	<ul style="list-style-type: none"> Variable by adjustments to the electronic control box Maximum hold open time adjustable up to approximately 32 seconds
System diagram	See pages 45 for typical system wiring and page 44 for electrical data
Maximum opening	Template allows 90 degree power opening and 90 degree manual opening

Notes:

- Push N' Go permits non-switch activation with power boost providing additional latching force
- Electromechanical unit with microprocessor control
- 36" header length is standard, specify length 33" - 49" max
- Double Door Header available 98", specify length 49" - 98" max
- Positive or Breakaway Stop available with Center Pivot Arm
- Adjustable hold open time of 1-32 seconds
- Actuators available separately, see pages 100-117

Mounting details

Concealed simultaneous pair

Offset pivot or butt hinge, slide arm, push

Shown with 3 3/4" pivot

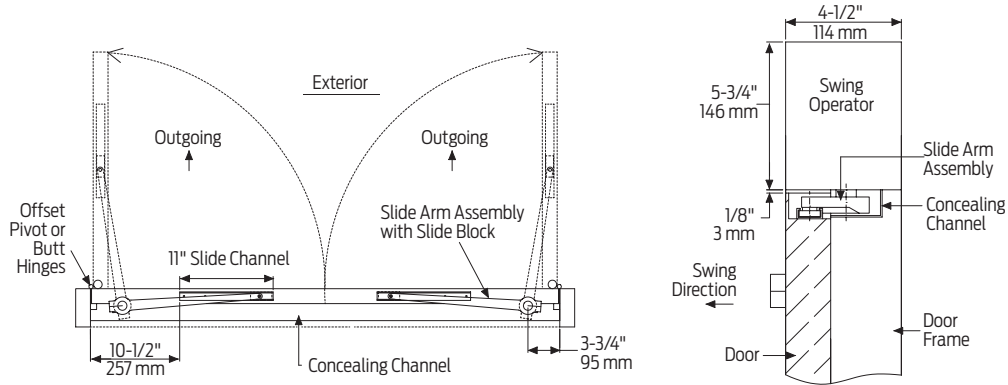

Top rail	Minimum 2" (51 mm)
Head frame	Minimum 52" (L) x 5 3/4" (H) x 4 1/2" (W) (1524 mm x 146 mm x 114 mm)
Opening and closing time	<ul style="list-style-type: none"> Variable by adjustments to the electronic control box Maximum hold open time adjustable up to approximately 32 seconds
System diagram	See pages 45 for typical system wiring and page 44 for electrical data
Maximum opening	Template allows 90 degree power opening and 90 degree manual opening

Notes:

- Push N' Go permits non-switch activation with power boost providing additional latching force
- Electromechanical unit with microprocessor control
- 36" header length is standard, specify length 33" - 49" max
- Double Door Header available 98", specify length 49" - 98" max
- Positive or Breakaway Stop available with Center Pivot Arm
- Adjustable hold open time of 1-32 seconds
- Actuators available separately, see pages 100-117

Introduction
 Product selection guide
 Pneumatic systems Auto equalizers 2610/4810/4820/4840/7900 Series
 Electrohydraulic systems Auto equalizers 4630/4640 Series
 Electromechanical systems Benchmark 9130/9140/9150 Series
 Electromechanical systems Senior Swing 2810/2850/2860/9530/9540/9550/9560 Series
 Actuators and accessories

Accessories

Motor gearbox



2850-3454
Standard Motor Gearbox (MGB)

- Senior Swing
- Driving mechanism for operator
- Provides maximum 15 lbs opening force
- Handed

Control box

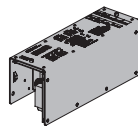

2850-3462
Standard Controller (CTRL)

- Senior Swing
- Electronic controlling device for Senior Swing

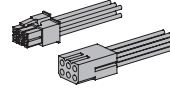

2850-982
Companion Cable

- Cable that allows one control box to run two motor gearboxes
- For use with Senior Swing

Arm



2850-3077CP
2 3/4" Center Pivot Arm (ARMCP)

- Center pivot installations only
- Used with overhead concealed operators and center pivoted doors



2850-3077OP
3 3/4" Offset Pivot Arm (ARMOP)

- Offset pivot or butt hung installations only
- Handed
- Used with overhead concealed operators

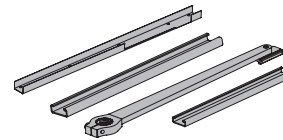

2850-3077OPCM
Offset Pivot Arm Assembly

- Offset Pivot Arm with track and concealing channel
- Includes 3072 Concealing Channel, 168 Slide Channel and 3077OP offset pivot arm

Brackets



2850-375
Mounting Bracket

- Motor gearbox mounting bracket for 3 3/4" offset pivot, butt hinge or center pivot with finger guard installations
- Front bracket



2850-275
Mounting Bracket

- Motor gearbox mounting bracket for 2 3/4" center pivot installations
- Front bracket



2850-3018
Rear Mounting Bracket

- Motor gearbox mounting bracket
- Rear bracket

Header

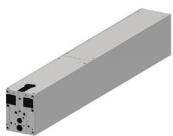

2850-3572HL
Standard Mounting Header (HDR)

- Mounting header
- Pair door, two operators
- Specify length 52" to 98" maximum
- Standard

End cap



2850-334
Header End Caps

- End cap with openings for wiring

Accessories

Channels

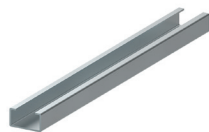

- 2850-3072
Concealing Channel**
- Used to conceal arm in overhead concealed applications
 - For offset pivot installations only
 - If ordering separately specify length and hand

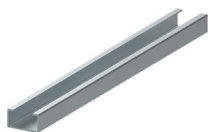

- 2850-168
Slide Channel**
- Offset pivot or butt hinge installations only
 - Mounts in top rail of door
 - Allows arm to slide

Pivots

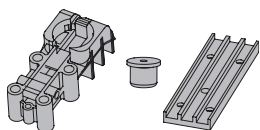

- 2850-3107
Bottom Pivot Assembly**
- Includes pivot body, pivot post and bottom pivot plate
 - For overhead concealed, center pivoted installations
 - Includes: 2850-107, 2850-110 and 2850-117

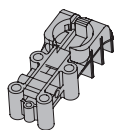

- 2850-107
Bottom Pivot Body**
- Pivot body for center pivoted installations



- 2850-110
Pivot Post**
- Connects pivot body to bottom pivot plate for center pivoted installations

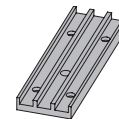

- 2850-117
Bottom Pivot Plate**
- Applied to floor for center pivoted installations

Installation accessories

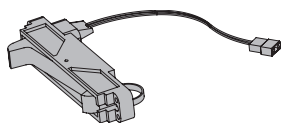

- 2850-384B
Breakaway Stop (BKY)**
- Allows in-swinging door to swing out in case of emergency
 - For center pivoted installations only



- 2850-384F
Positive Stop (POS)**
- Prevents out-swinging door from swinging in
 - For center pivoted installations only



- 2850-12
Filler Plate Blank**
- Completes length of header box



- 2850-11A
Spindle Plate**
- Hides bottom of motor gearbox
 - Completes header box
 - Cutout allows for motor gearbox shaft
 - For 2 3/4" center pivot installations



- 2850-11B
Spindle Plate**
- Hides bottom of motor gearbox
 - Completes header box
 - Cutout allows for motor gearbox shaft
 - For 3 3/4" offset pivot, butt hinge or center pivot with finger guard installations

Introduction
 Product selection guide
 Pneumatic systems
 Auto equalizers
 2610/4810/4820/4840/7900 Series
 Electrohydraulic systems
 Auto equalizers
 4630/4640 Series
 Electromechanical systems
 Benchmark
 9130/9140/9150 Series
 Electromechanical systems
 Senior Swing
 2810/2850/2860/9530/9540/9550/9560 Series
 Actuators and accessories

Ordering information

How-to-order 2850 Series operators

1. Select installation type

- 2853

2. Specify arm

- 3 3/4" Offset Pivot Arm (ARMOP)
- 2 3/4" Center Pivot Arm (ARMCP)
- 3 3/4" Center Pivoted Arm (3077CP)

3. Specify hand

- Right hand (RH)
- Left hand (LH)

4. Specify header/length

- Standard Mounting Header (HDR)
(Specify length 52" to 98")

5. Select finish

- Standard anodized finish _____
Aluminum, Clear Anodized (628) or
Dark Bronze, Anodized (710).

Operator will be shipped with:

- Standard motor gearbox (1 LH and 1 RH)
- Standard control box
- Companion cable
- Header (at specified length - 72" standard)
- 2 3/4" pivot point
- Wood and machine screws
(unless options listed below are selected)

Operator options

Stops

- Positive Stop (POS)
- Breakaway Stop (BKY)

Note: Available with Center Pivoted installations only.

Table of sizes

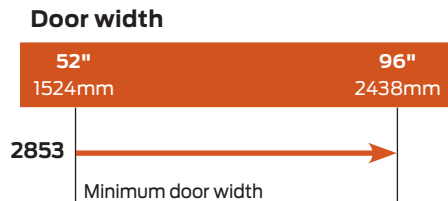

➔ Indicates recommended range of door width for operator.
Note: For all Senior Swing Series. Simultaneous Pair – Width per leaf 26" minimum to 48" maximum.

2860 Series



The 2860 Senior Swing by LCN is an ADA door operator that is a two-in-one swing door operator. Senior swing operator when activated, opens doors automatically for wheelchair access, yet allows for manual operation for regular pedestrian traffic.

Features

Certifications	Grade 1 - ANSI A156.19, UL325/228, UL1998, ADA, 100 Hour Salt Spray, Meets BAA - Buy American Act
Handing	Handed
Door width	<ul style="list-style-type: none"> Combined width min 52" - 96" Simultaneous pair - width per leaf 26" minimum to 48" maximum
Warranty	2 years

Fasteners	Wood and Machine Screws (WMS)
Mounting	Independent pair, overhead concealed, center pivot, offset pivot, butt hinge
Arms	Offset Pivot Arm or Center Pivot Arm
Finishes/colors/powder coat	<ul style="list-style-type: none"> 628 Aluminum, Anodized 710 Dark Brown, Anodized

Special templates | Customized installation templates or products may be available to solve non-standard applications. Contact LCN Product Support for assistance.

Mounting	Handing	Finish	Cover	Arm function
Surface mount single door	Handed*	Standard anodized	Standard (single lever)	Offset pivot arm
Surface mount simultaneous pair	Non-handed	Metal	Regular (double lever)	Center pivot arm
Surface mount independent pair			Double egress (push/pull)	
Concealed single door				
Concealed simultaneous pair				
Concealed independent pair				

■ Available
■ Not available

* Handed for 2850 and 2860, double egress only.

Introduction
 Product selection guide
 Pneumatic systems / Auto equalizers / 2610/4810/4820/4840/7900 Series
 Electrohydraulic systems / Auto equalizers / 4630/4640 Series
 Electromechanical systems / Benchmark / 9130/9140/9150 Series
 Electromechanical systems / Senior Swing / 2810/2850/2860/9530/9540/9550/9560 Series
 Actuators and accessories

Mounting details

Concealed independent pair

Center pivot, breakaway stop, pull

Shown with 3 3/4" pivot

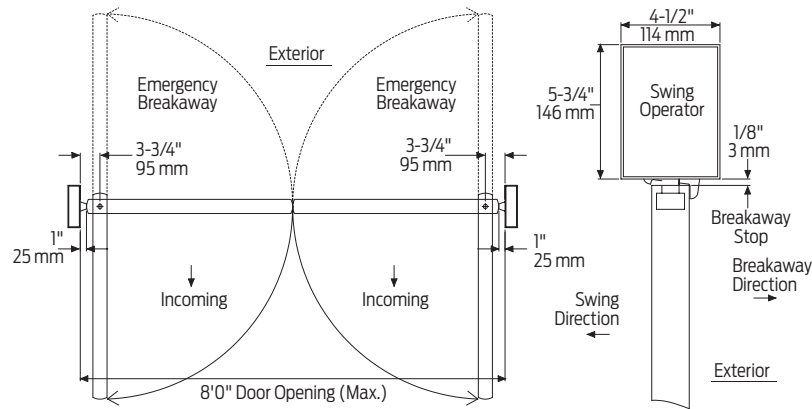

Center pivot, positive stop, push

Shown with 3 3/4" pivot

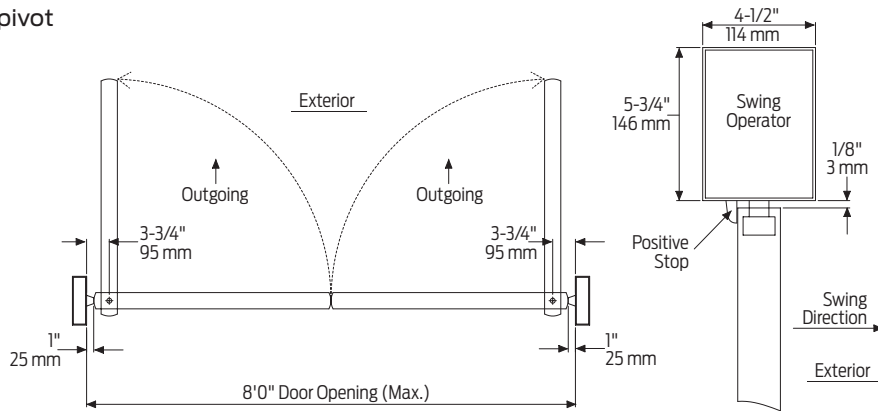

Top rail	Minimum 2" (51 mm)
Head frame	Minimum 65" (L) x 5 3/4" (H) x 4 1/2" (W) (1651 mm x 146 mm x 114 mm)
Opening and closing time	<ul style="list-style-type: none"> Variable by adjustments to the electronic control box Maximum hold open time adjustable up to approximately 32 seconds
System diagram	See pages 45 for typical system wiring and page 44 for electrical data
Maximum opening	Template allows 90 degree power opening and 90 degree manual opening

Notes:

- Push N' Go permits non-switch activation with power boosts providing additional latching force
- Electromechanical unit with microprocessor control
- Digital keypad for easy setup
- 72" header length is standard. Specify other length 65" - 98" max (consult factory with this option)
- Adjustable hold time of 1-32 seconds
- Actuators available separately, see pages 100-117

Mounting details

Concealed independent pair

Offset pivot or butt hinge, push

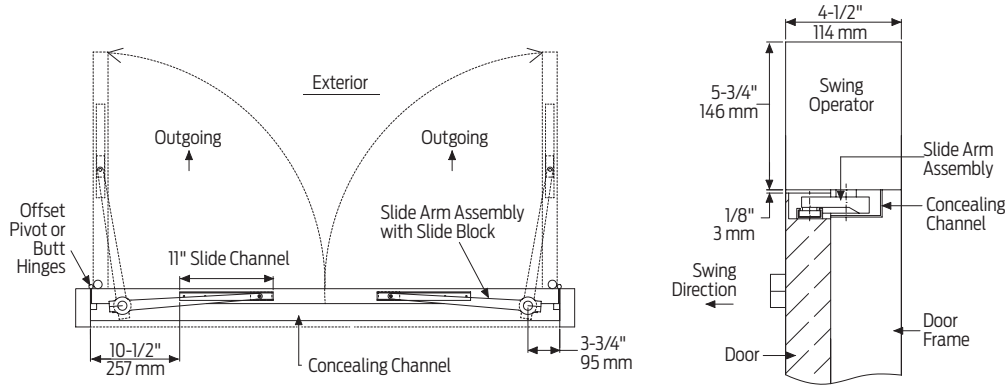

Top rail	Minimum 2" (51 mm)
Head frame	Minimum 65" (L) x 5 3/4" (H) x 4 1/2" (W) (1651 mm x 146 mm x 114 mm)
Opening and closing time	<ul style="list-style-type: none"> Variable by adjustments to the electronic control box Maximum hold open time adjustable up to approximately 32 seconds
System diagram	See pages 45 for typical system wiring and page 44 for electrical data
Maximum opening	Template allows 90 degree power opening and 90 degree manual opening

Notes:

- Offset pivot installations require a bottom pivot and two intermediate pivots
- Push N' Go permits non-switch activation with power boosts providing additional latching force
- Electromechanical unit with microprocessor control
- Digital keypad for easy setup
- 72" header length is standard. Specify other length 65" - 98" max (consult factory with this option)
- Optional Positive (POS) or Breakaway Stop (BKY) available (Center Pivot Arm)
- Header lengths 70" - 98" max with either POS or BKY
- Adjustable hold time of 1-32 seconds
- Actuators available separately, see pages 100-117

Introduction
 Product selection guide
 Pneumatic systems Auto equalizers 2610/4810/4820/4840/7900 Series
 Electrohydraulic systems Auto equalizers 4630/4640 Series
 Electromechanical systems Benchmark 9130/9140/9150 Series
 Electromechanical systems Senior Swing 2810/2850/2860/9530/9540/9550/9560 Series
 Actuators and accessories

Accessories

Motor gearbox



- 2860-3454
Standard Motor Gearbox (MGB)**
- Senior Swing
 - Handed
 - Driving mechanism for operator
 - Provides maximum 15 lbs opening force

Control box

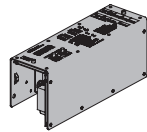

- 2860-3462
Standard Controller (CTRL)**
- Electronic controlling device for Senior Swing

Arm



- 2860-3077CP
2 3/4" Center Pivot Arm (ARMCP)**
- Center pivot installations only
 - Used with overhead concealed operators and center pivoted doors



- 2860-3077OP
3 3/4" Offset Pivot Arm (ARMOP)**
- Offset pivot or butt hung installations only
 - Used with overhead concealed operators

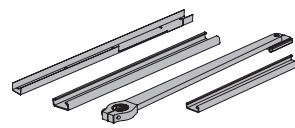

- 2860-3077OPCM
Offset Pivot Arm Assembly**
- Offset arm with track and concealing channel
 - Includes 3072 Concealing Channel, 168 Slide Channel and 3077OP Offset Pivot Arm

Brackets



- 2860-375
Mounting Bracket**
- Motor gearbox mounting bracket for 3 3/4" offset pivot, butt hinge or center pivot with finger guard installations
 - Front bracket

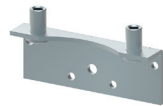

- 2860-275
Mounting Bracket**
- Motor gearbox mounting bracket for 3 3/4" center pivot installations
 - Front bracket



- 2860-3018
Rear Mounting Bracket**
- Motor gearbox mounting bracket
 - Rear bracket

Header

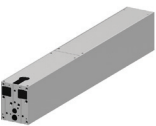

- 2860-3572HL
Standard Mounting Header (HDR)**
- Pair door, two operators
 - Specify length 65" to 98" maximum
 - Standard

End cap



- 2860-334
Header End Caps**
- With openings for wiring

Accessories

Channels

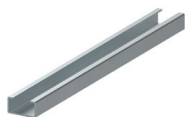

2860-3072
Concealing Channel

- Used to conceal arm in overhead concealed applications
- For offset pivot installations only
- If ordering separately specify length and hand

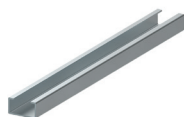

2860-168
Slide Channel

- Offset pivot or butt hinge installations only
- Mounts in top rail of door
- Allows arm to slide

Pivots

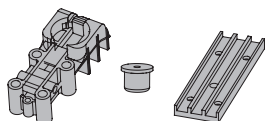

2860-3107
Bottom Pivot Assembly

- Includes pivot body, pivot post and bottom pivot plate
- For overhead concealed, center pivoted installations
- Includes: 2860-107, 2860-110 and 2860-117

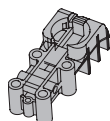

2860-107
Bottom Pivot Body

- Pivot body for center pivoted installations



2860-110
Pivot Post

- Connects pivot body to bottom pivot plate for center pivoted installations

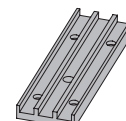

2860-117
Bottom Pivot Plate

- Applied to floor for center pivoted installations

Installation accessories

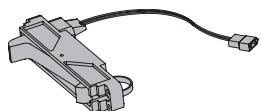

2860-384B
Breakaway Stop (BKY)

- Allows in-swinging door to swing out in case of emergency
- For center pivoted installations only



2860-384F
Positive Stop (POS)

- Prevents out-swinging door from swinging in
- For center pivoted installations only



2860-12
Filler Plate Blank

- Completes length of header box



2860-11A
Spindle Plate

- Hides bottom of motor gearbox
- Completes header box
- Cutout allows for motor gearbox shaft
- For 2 3/4" center pivot installations



2860-11B
Spindle Plate

- Hides bottom of motor gearbox
- Completes header box
- Cutout allows for motor gearbox shaft
- For 3 3/4" offset pivot, butt hinge or center pivot with finger guard installations

Introduction
 Product selection guide
 Pneumatic systems
 Auto equalizers
 2610/4810/4820/4840/7900 Series
 Electrohydraulic systems
 Auto equalizers
 4630/4640 Series
 Electromechanical systems
 Benchmark
 9130/9140/9150 Series
 Electromechanical systems
 Senior Swing
 2810/2850/2860/9530/9540/9550/9560 Series
 Actuators and accessories

Ordering information

How-to-order 2860 Series operators

1. Select installation type

- 2863

2. Specify arm

- 3 3/4" Offset Pivot Arm (ARMOP)
- 2 3/4" Center Pivot Arm (ARMCP)

3. Specify hand

- Right hand (RH)
- Left hand (LH)

4. Specify header/length

- Standard Mounting Header (HDR)
(Specify length 65" to 98")

5. Select finish

- Standard anodized finish _____
Aluminum, Clear Anodized (628) or
Dark Bronze, Anodized (710).

Operator will be shipped with:

- Standard motor gearbox (1 LH and 1 RH)
- Standard control box (2 ea)
- Header (at specified length - 72" standard)
- 2 3/4" pivot point
- Wood and machine screws
(unless options listed below are selected)

Operator options

Stops

- Positive Stop (POS)
- Breakaway Stop (BKY)

Note: Available with Center Pivoted installations only.

Table of sizes

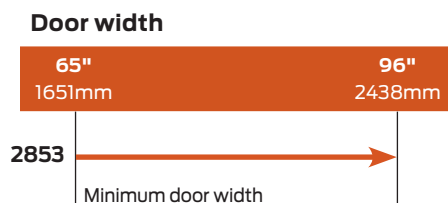

Indicates recommended range of door width for operator.

Note: For all Senior Swing Series. Independent Pair – Width per leaf 32 1/2" minimum to 48" maximum

9530 Series



The 9530 Senior Swing by LCN is an ADA door operator that is a two-in-one swing door operator. Senior swing operator when activated, opens doors automatically for wheelchair access, yet allows for manual operation for regular pedestrian traffic.

Features

Certifications	Grade 1 - ANSI A156.19, UL325/228, UL1998, ADA, 100 Hour Salt Spray, Meets BAA - Buy American Act
Fluid	All Weather Fluid
Handing	Handed
Door width	<ul style="list-style-type: none"> Minimum 33" - 48" Single door - width per leaf 33" minimum to 48" maximum
Warranty	2 years

Fasteners	Machine Screws (MS)
Mounting	Single door, surface mount, offset pivot, butt hinge, pull side
Arms	Standard arm (3077T)
Finishes/colors/powder coat	<ul style="list-style-type: none"> 628 Aluminum, Anodized 710 Dark Brown, Anodized

Special templates | Customized installation templates or products may be available to solve non-standard applications. Contact LCN Product Support for assistance.

Mounting	Handing	Finish	Cover	Arm function
Surface mount single door	Handed	Standard anodized	Standard (single lever)	Offset pivot arm
Surface mount simultaneous pair	Non-handed	Metal	Regular (double lever)	Center pivot arm
Surface mount independent pair			Double egress (push/pull)	
Concealed single door				
Concealed simultaneous pair				
Concealed independent pair				

■ Available
■ Not available

Introduction
 Product selection guide
 Pneumatic systems / Auto equalizers / 2610/4810/4820/4840/7900 Series
 Electrohydraulic systems / Auto equalizers / 4630/4640 Series
 Electromechanical systems / Benchmark / 9130/9140/9150 Series
 Electromechanical systems / Senior Swing / 2810/2850/2860/9530/9540/9550/9560 Series
 Actuators and accessories

Mounting details

Top jamb single door mounting

Offset pivot/butt hinge, center pivot, pull

Note: Cannot be used with swing clear hinges, pocket pivots or balanced doors.

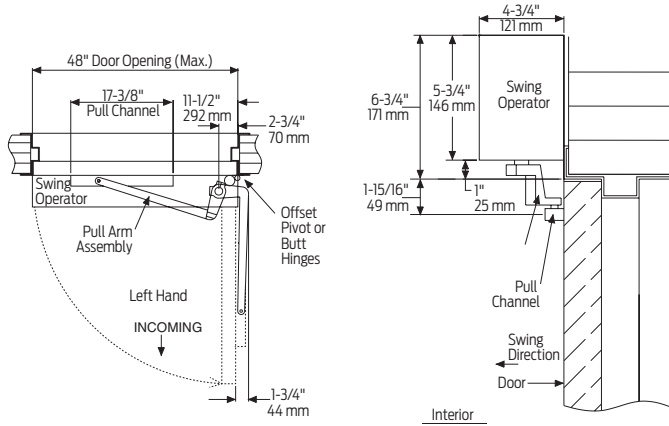

Hollow metal frame

The 18 plate is 1/4" thick and will need to be ordered 3 1/2" longer than the header to allow for mounting the angle brackets to the vertical side jambs. See illustration below.

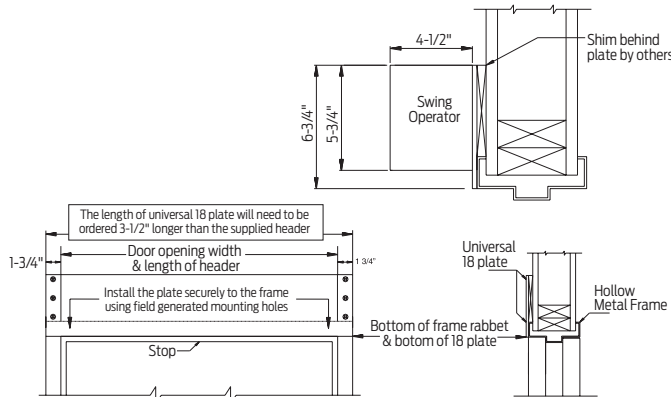

Note: Suggested installation.

Butt hinges	Should not exceed 5" (127 mm) in width
Reveal	Should not exceed 4" (102 mm)
Top rail	Minimum 2 3/4" (70 mm)
Head frame	Minimum 1 3/4" (44 mm); face frame 6 3/4" (171 mm) total operator clearance
Opening and closing time	<ul style="list-style-type: none"> Variable by adjustments to the electronic control box Maximum hold open time adjustable up to approximately 32 seconds
System diagram	See pages 45 for typical system wiring and page 44 for electrical data
Maximum opening	Template allows 90 degree power opening and 90 degree manual opening

Notes:

- Push N' Go permits non-switch activation with a power boost providing additional latching force
- Electromechanical unit with microprocessor control
- Digital keypad for easy setup
- 36" header length is standard. Specify 33" - 48" max
- Double Door Header available up to 98", specify other length 49"- 98" max
- Consult factory regarding this option
- Adjustable hold open period of 2 - 32 seconds in automatic or manual mode
- Actuators available separately, see pages 100-117

Accessories

Motor gearbox



- 9530-3454**
Standard Motor Gearbox (MGB)
- Senior Swing
 - Handed
 - Driving mechanism for operator
 - Provides maximum 15 lbs opening force

Control box

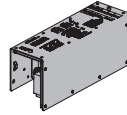

- 9530-3462**
Standard Controller (CTRL)
- Electronic controlling device for Senior Swing

Arm



- 9530-3077PLCM**
Standard Arm Assembly with Track Roller (STDTRKARM2)
- Handed
 - Track roller included (includes 3038, 3077T, 3034 and 73)



- 9530-3077T**
Standard Arm (STDTRKARM)
- Handed
 - Track roller not included

Track



- 9530-3038**
Track
- Non-handed
 - Includes 3034 and 73



- 9530-73**
Track End Cap
- Black plastic end caps



- 9530-3034**
Roller
- Quiet low friction roller assembly

Header

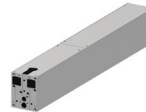

- 9530-3572HL**
Standard Mounting Header (HDR)
- Standard
 - Single door, single operator
 - Specify length 33" to 48" maximum

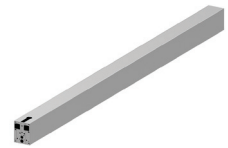

- 9530-3572DD**
Double Door Header (HDR2)
- Standard
 - Double door, single operator
 - Specify length 49" to 48" maximum

Brackets



- 9530-275**
Mounting Bracket
- Motor gearbox mounting bracket for 2 3/4" offset pivot or butt hinge installations
 - Front bracket



- 9530-3018**
Rear Mounting Bracket
- Motor gearbox mounting bracket
 - Rear bracket



- 9530-334-1**
Angle Brackets (HLB)
- Mounting bracket for surface applications (includes 2 mounting brackets)

End cap



- 9530-334**
Header End Caps
- With openings for wiring



- 9530-334-2**
Dress plates (HLD)
- Metal finish end cap

Installation accessories



- 9530-11A**
Spindle Plate
- Hides bottom of motor gearbox
 - Completes header box
 - Cutout allows for motor gearbox shaft
 - For 2 3/4" offset pivot or butt hinge installations



- 9530-12**
Filler
- Plate blank
 - Completes length of header box (specify length)



- 9530-18**
Mounting Plate
- Optional mounting plate for standard hollow metal door frames
 - Specify length 36 1/2" to 101 1/2" maximum, when angle brackets
 - Specify length 33" to 98" maximum when using dress plates

NOTE: The length of a universal 18 plate will need to be ordered 3-1/2" longer than the supplied header when using angle brackets

Introduction
 Product selection guide
 Pneumatic systems / Auto equalizers / 2610/4810/4820/4840/7900 Series
 Electrohydraulic systems / Auto equalizers / 4630/4640 Series
 Electromechanical systems / Benchmark / 9130/9140/9150 Series
 Electromechanical systems / Senior Swing / 2810/2850/2860/9530/9540/9550/9560 Series
 Actuators and accessories

Ordering information

How-to-order 9530 Series operators

1. Specify hand

- Right hand (RH)
- Left hand (LH)

2. Specify header/length

- Standard Mounting Header (HDR)
(Specify length 33" to 48")
- Double Door Header (HDR2)
(Specify length 49" to 98")

3. Select finish

- Standard anodized finish _____
Aluminum, Clear Anodized (628) or
Dark Bronze, Anodized (710).

Operator will be shipped with:

- Standard motor gearbox (1 LH and 1 RH)
- Standard control box (2 ea)
- Header (at specified length, 36" standard)
- Standard Arm (3077T)
- Standard track with track roller
- Machine screws
(unless options listed below are selected)

Operator options

Mounting plate

- Plate, ___ (Specify Length 33" to 101½")

Table of sizes

Door width



Indicates recommended range of door width for operator.
Note: For all Senior Swing Series. Single Door - Width per leaf 33" minimum, 48" maximum.

9540 Series



The 9540 Senior Swing by LCN is an ADA door operator that is a two-in-one swing door operator. Senior swing operator when activated, opens doors automatically for wheelchair access, yet allows for manual operation for regular pedestrian traffic.

Features

Certifications	Grade 1 - ANSI A156.19, UL325/228, UL1998, ADA, 100 Hour Salt Spray, Meets BAA - Buy American Act
Fluid	All Weather Fluid
Handing	Handed
Door width	<ul style="list-style-type: none"> Combined width min 33" - 48" Single door - width per leaf 33" minimum to 48" maximum
Warranty	2 years

Fasteners	Machine Screws (MS)
Mounting	Single door, surface mount, offset pivot, butt hinge, push side
Arms	Regular Arm (3077)
Finishes/colors/powder coat	<ul style="list-style-type: none"> 628 Aluminum, Anodized 710 Dark Brown, Anodized

Special templates | Customized installation templates or products may be available to solve non-standard applications. Contact LCN Product Support for assistance.

Mounting	Handing	Finish	Cover	Arm function
Surface mount single door	Handed	Standard anodized	Standard (single lever)	Regular (push/pull)
Surface mount simultaneous pair	Non-handed	Metal	Regular (double lever)	Offset egress (push/pull)
Surface mount independent pair			Double egress (push/pull)	Center pivot arm
Concealed single door				
Concealed simultaneous pair				
Concealed independent pair				

■ Available
■ Not available

Introduction
 Product selection guide
 Pneumatic systems / Auto equalizers / 2610/4810/4820/4840/7900 Series
 Electrohydraulic systems / Auto equalizers / 4630/4640 Series
 Electromechanical systems / Benchmark / 9130/9140/9150 Series
 Electromechanical systems / Senior Swing / 2810/2850/2860/9530/9540/9550/9560 Series
 Actuators and accessories

Mounting details

Top jamb single door mounting

Offset pivot/butt hinge, center pivot, push

Note: Consult factory for all balance door installations.

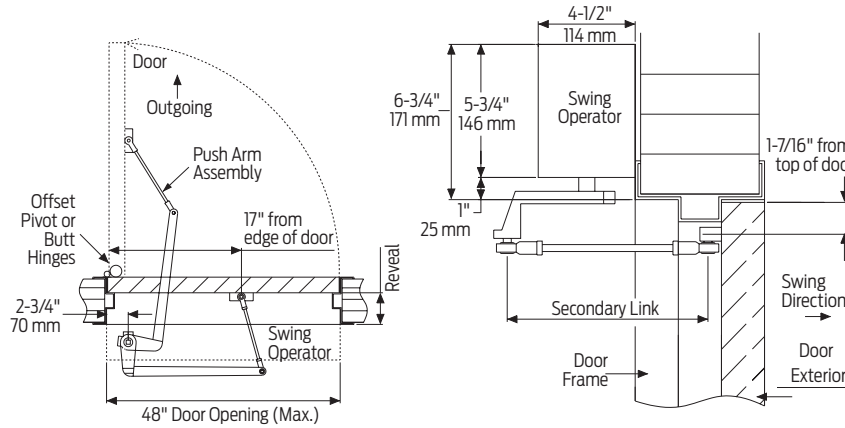

Hollow metal frame

The 18 plate is 1/4" thick and will need to be ordered 3 1/2" longer than the header to allow for mounting the angle brackets to the vertical side jambs. See illustration below.

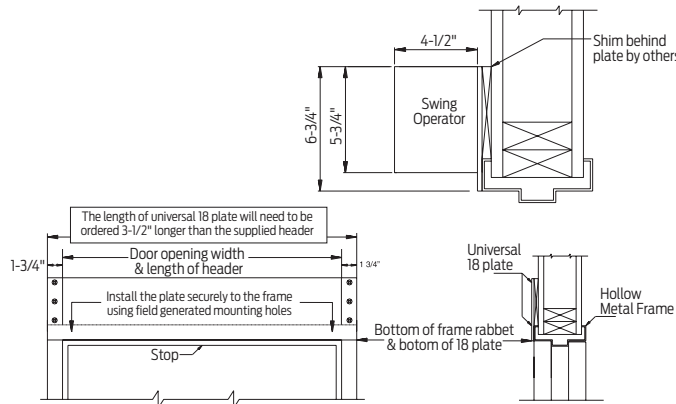

Note: Suggested installation.

Butt hinges	Should not exceed 5" (127 mm) in width
Reveal	Push installations should not exceed 10" (254 mm) for regular arm and 20" (508 mm) for long arm
Top rail	Minimum 2 3/4" (70 mm)
Head frame	Minimum 1 3/4" (44 mm); face frame 6 3/4" (171 mm) total operator clearance
Opening and closing time	<ul style="list-style-type: none"> Variable by adjustments to the electronic control box Maximum hold open time adjustable up to approximately 32 seconds
System diagram	See pages 45 for typical system wiring and page 44 for electrical data
Maximum opening	Template allows 90 degree power opening and 90 degree manual opening

Notes:

- Push N' Go permits non-switch activation with a power boost providing additional latching force
- Electromechanical unit with microprocessor control
- Digital keypad for easy setup
- 36" header length is standard. Specify 33" - 48" max
- Double Door Header available up to 98", specify other length 49"- 98" max
- Consult factory regarding this option
- Adjustable hold open period of 2 - 32 seconds in automatic or manual mode
- Actuators available separately, see pages 100-117

Accessories

Motor gearbox



- 9540-3454
Standard Motor Gearbox (MGB)**
- Senior Swing
 - Handed
 - Driving mechanism for operator
 - Provides maximum 15 lbs opening force

Control box

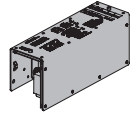

- 9540-3462
Standard controller (CTRL)**
- Electronic controlling device for Senior Swing

Brackets



- 9540-275
Mounting Bracket**
- Motor gearbox mounting bracket for 2 3/4" offset pivot or butt hinge installations
 - Front bracket



- 9540-3018
Rear Mounting Bracket**
- Motor gearbox mounting bracket
 - Rear bracket



- 9540-334-1
Angle Brackets (HLB)**
- Mounting bracket for surface applications (includes 2 mounting brackets)

Arm

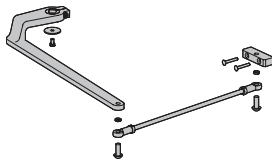

- 9540-3077
Regular Arm (REGARM)**
- Handed
 - Includes 77 main arm assembly and 79 linkage assembly

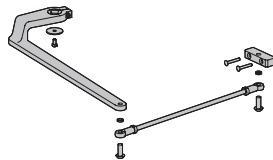

- 9540-3077L
Long Arm (LONG)**
- Handed
 - Includes 77 main arm assembly and 79LR linkage assembly

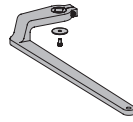

- 9540-77
Main Arm**
- Handed
 - Attaches to motor gearbox

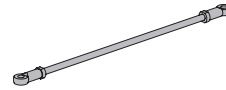

- 9540-79
Linkage Assembly - 15"**
- Threaded rod attaches to door
 - Extends from main arm

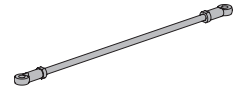

- 9540-79LR
Linkage Assembly - 32"**
- Threaded long rod attaches to door
 - Extends from main arm
 - Used for reveal 10" to 20"

Header



- 9540-3572HL
Standard Mounting Header (HDR)**
- Single door, single operator
 - Specify length 33" to 48" maximum
 - Standard

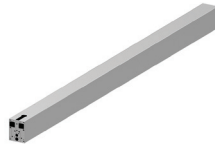

- 9540-3572DD
Double Door Header (HDR)**
- Double door, single operator
 - Specify length 49" to 98" maximum
 - Standard

End cap



- 9540-334
Header End Caps**
- With openings for wiring



- 9540-334-2
Dress plates (HLD)**
- Metal finish end cap

Installation accessories



- 9540-11A
Spindle Plate**
- Hides bottom of motor gearbox
 - Completes header box
 - Cutout allows for motor gearbox shaft
 - For 2 3/4" offset pivot or butt hinge installations



- 9540-12
Filler Plate Blank**
- Completes length of header box (specify length)



- 9540-18
Mounting Plate**
- For standard hollow metal door frames
 - Specify length 55 1/2" to 101 1/2" maximum when using angle brackets
 - Specify length 52" to 98" maximum when using dress plates
 - Optional

Note: The length of a universal 18 plate will need to be ordered 3 1/2" longer than the supplied header when using angle brackets.

Introduction
 Product selection guide
 Pneumatic systems
 Auto equalizers
 2610/4810/4820/4840/7900 Series
 Electrohydraulic systems
 Auto equalizers
 4630/4640 Series
 Electromechanical systems
 Benchmark
 9130/9140/9150 Series
 Electromechanical systems
 Senior Swing
 2810/2850/2860/9530/9540/9550/9560 Series
 Actuators and accessories

Ordering information

How-to-order 9540 Series operators

1. Specify hand

- Right hand (RH)
- Left hand (LH)

2. Specify header/length

- Standard Mounting Header (HDR)
(Specify length 33" to 48")
- Double Door Header (HDR2)
(Specify length 49" to 98")

3. Select finish

- Standard anodized finish _____
Aluminum, Clear Anodized (628) or
Dark Bronze, Anodized (710).

Closer will be shipped with:

- Standard motor gearbox
- Standard control box
- Header (at specified length, 36" standard)
- Regular Arm (3077)
- 2 3/4" pivot point
- Machine screws
(unless options listed below are selected)

Operator options

Mounting plate

- Plate, ___ (Specify Length 33" to 101 1/2")

Arm

- Long Arm (LONG)

Table of sizes

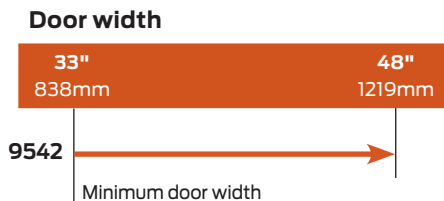

→ Indicates recommended range of door width for operator.
 Note: For all Senior Swing Series. Single Door - Width per leaf 33" minimum, 48" maximum.

9550 Series



The 9550 Senior Swing by LCN is an ADA door operator that is a two-in-one swing door operator. Senior swing operator when activated, opens doors automatically for wheelchair access, yet allows for manual operation for regular pedestrian traffic.

Features

Certifications	Grade 1 - ANSI A156.19, UL325/228, UL1998, ADA, 100 Hour Salt Spray, Meets BAA - Buy American Act
Handing	Handed
Door width	<ul style="list-style-type: none"> Minimum combined door width 52" - 98" (push) Minimum combined door width 60" - 98" (pull; double egress) Simultaneous pair - width per leaf 30" minimum - 48" maximum
Warranty	2 years

Fasteners	Machine Screws (MS)
Mounting	Simultaneous pair, surface mount, pull side, push side, double egress
Arms	<ul style="list-style-type: none"> 2 Regular Arms (push) 2 Standard Arms (pull) 1 Regular and 1 Standard (double egress)
Finishes/colors/ powder coat	<ul style="list-style-type: none"> 628 Aluminum, Anodized 710 Dark Brown, Anodized

Special templates | Customized installation templates or products may be available to solve non-standard applications. Contact LCN Product Support for assistance.

Mounting	Handing	Finish	Cover	Arm function
Surface mount single door	Handed	Standard anodized	Standard (single lever)	Regular (push/pull)
Surface mount simultaneous pair	Non-handed	Metal	Regular (double lever)	Double egress (push/pull)
Surface mount independent pair			Offset pivot arm	Center pivot arm
Concealed single door				
Concealed simultaneous pair				
Concealed independent pair				

■ Available (orange square) ■ Not available (black square)

Introduction
 Product selection guide
 Pneumatic systems / Auto equalizers 2610/4810/4820/4840/7900 Series
 Electrohydraulic systems / Auto equalizers 4630/4640 Series
 Electromechanical systems / Benchmark 9130/9140/9150 Series
 Electromechanical systems / Senior Swing 2810/2850/2860/9530/9540/9550/9560 Series
 Actuators and accessories

Mounting details

Top jamb simultaneous pair mounting

Offset pivot/butt hinge, center pivot, push

Note: Consult factory for all balanced door installations.

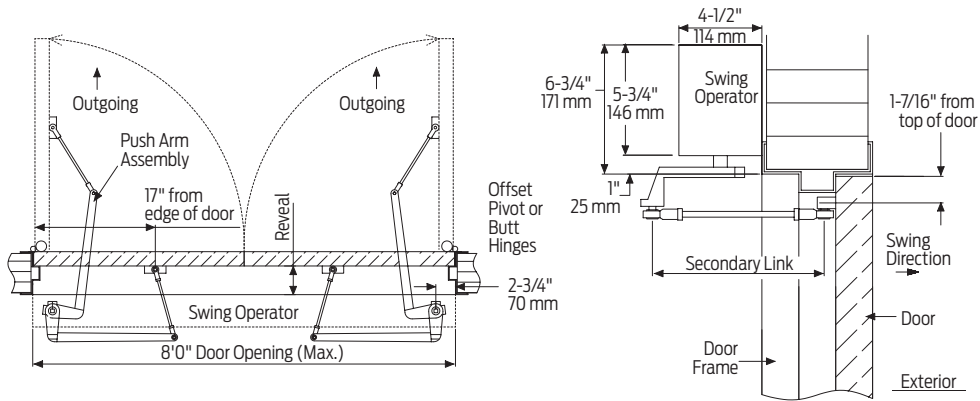

Offset pivot/ butt hinge, center pivot, pull

Note: Cannot be used with swing clear hinges, pocket pivots or balanced doors.

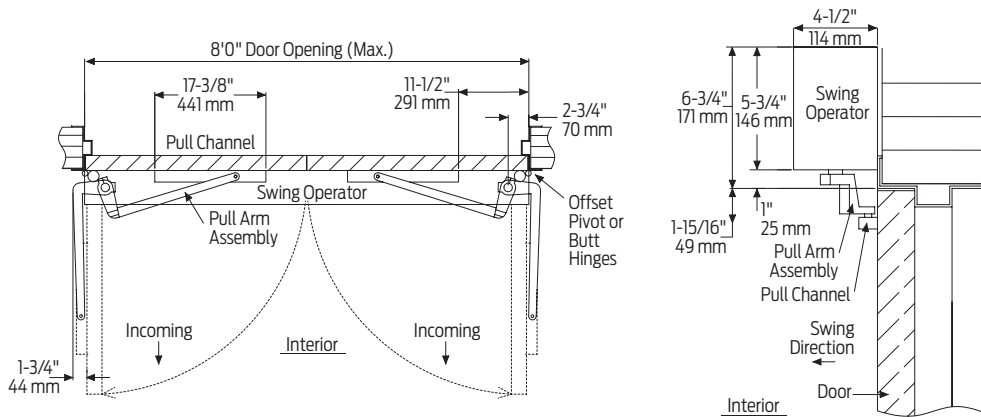

Butt hinges	Should not exceed 5" (127 mm) in width
Reveal for push	Should not exceed 10" (254 mm) for Regular Arm and 20" (508 mm) for Long Arm
Reveal for pull	Should not exceed 4" (102 mm)
Reveal	Double egress installations should not exceed 4" (102 mm)
Top rail	Minimum 2 3/4" (70 mm)
Head frame	<ul style="list-style-type: none"> Minimum 1 3/4" (44 mm) Face frame 6 3/4" (171 mm) total operator clearance
Opening and closing time	<ul style="list-style-type: none"> Variable by adjustments to the electronic control box Maximum hold open time adjustable up to approximately 32 seconds
System diagram	See pages 45 for typical system wiring and page 44 for electrical data
Maximum opening	Template allows 90 degree power opening and 90 degree manual opening

Notes:

- Push N' Go permits non-switch activation with a power boost providing additional latching force
- Electromechanical unit with microprocessor control
- Digital keypad for easy setup
- 72" header length is standard. Specify other length 52" - 98" (push), specify other length 60" - 98" (pull; double egress) (consult factory regarding this option)
- Adjustable hold open period of 2 - 32 seconds in automatic or manual mode
- Actuators available separately, see pages 100-117

Mounting details

Top jamb simultaneous pair mounting

RH double egress

Double egress applications with safety sensors require LCN 9560 Series.

Note: Cannot be used with swing clear hinges, pocket pivots or balanced door.

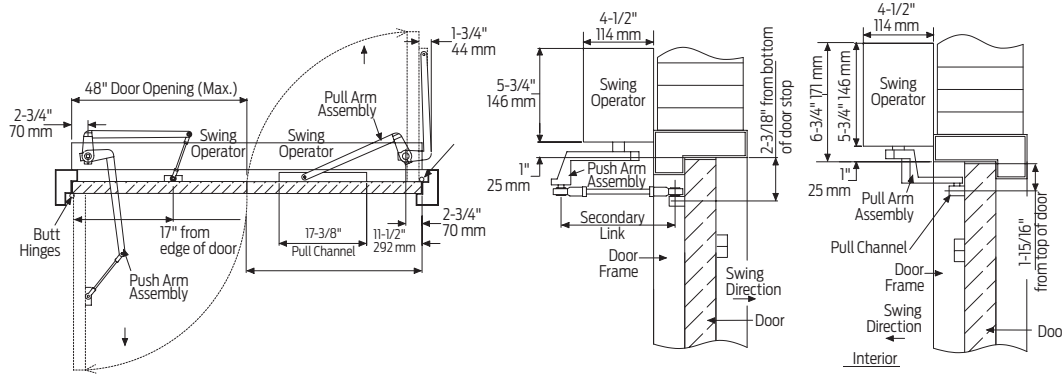

Hollow metal frame

The 18 plate is 1/4" thick and will need to be ordered 3 1/2" longer than the header to allow for mounting the angle brackets to the vertical side jambs. See illustration below.

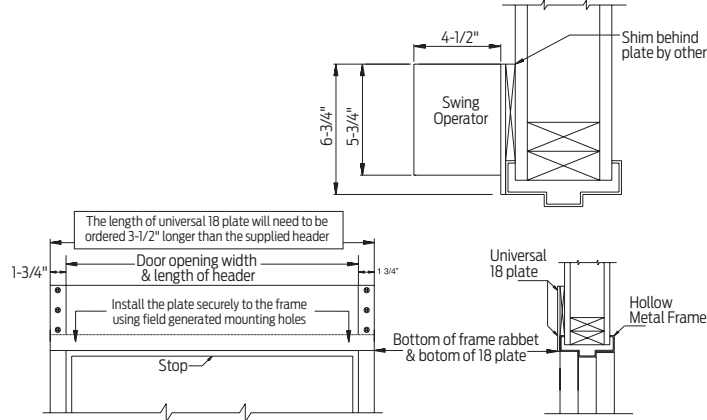

Note: Suggested installation.

Butt hinges	Should not exceed 5" (127 mm) in width
Reveal for push	Should not exceed 10" (254 mm) for Regular Arm and 20" (508 mm) for Long Arm
Reveal for pull	Should not exceed 4" (102 mm)
Reveal	Double egress installations should not exceed 4" (102 mm)
Top rail	Minimum 2 3/4" (70 mm)
Head frame	<ul style="list-style-type: none"> Minimum 1 3/4" (44 mm) Face frame 6 3/4" (171 mm) total operator clearance
Opening and closing time	<ul style="list-style-type: none"> Variable by adjustments to the electronic control box Maximum hold open time adjustable up to approximately 32 seconds
System diagram	See pages 45 for typical system wiring and page 44 for electrical data
Maximum opening	Template allows 90 degree power opening and 90 degree manual opening

Notes:

- Push 'N' Go permits non-switch activation with a power boost providing additional latching force
- Electromechanical unit with microprocessor control
- Digital keypad for easy setup
- 72" header length is standard. Specify other length 52" - 98" (push), specify other length 60" - 98" (pull; double egress) (consult factory regarding this option)
- Adjustable hold open period of 2 - 32 seconds in automatic or manual mode
- Actuators available separately, see pages 100-117

Introduction
 Product selection guide
 Pneumatic systems Auto equalizers 2610/4810/4820/4840/7900 Series
 Electrohydraulic systems Auto equalizers 4630/4640 Series
 Electromechanical systems Benchmark 9130/9140/9150 Series
 Electromechanical systems Senior Swing 2810/2850/2860/9530/9540/9550/9560 Series
 Actuators and accessories

Accessories

Motor gearbox



**9550-3454
Standard Motor Gearbox (MGB)**

- Senior Swing
- Handed
- Driving mechanism for operator
- Provides maximum 15 lbs opening force

Control box

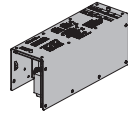

**9550-3462
Standard Controller (CTRL)**

- Electronic controlling device for Senior Swing

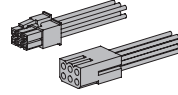

**9550-982
Companion Cable**

- Cable that allows one control box to run two motor gear boxes
- For use with Senior Swing

Arm



**9550-3077PLCM
Standard Arm Assembly with Track Roller (STDTRKARM2)**

- Handed
- Includes 3077 regular arm assembly, 3038 track, and 3034 track roller

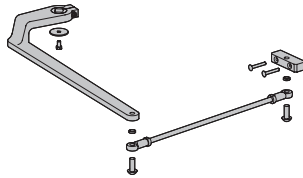

**9550-3077L
Long Arm (LONG)**

- Handed
- Includes 77 main arm assembly and 79LR linkage assembly

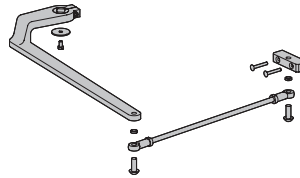

**9550-3077
Regular Arm (REGARM)**

- Handed
- Includes 77 main arm assembly and 79 linkage assembly



**9550-3077T
Standard Arm (STDTRKARM)**

- Handed
- Track roller not included

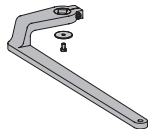

**9550-77
Main Arm**

- Handed
- Attaches to motor gearbox

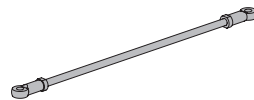

**9550-79
Linkage Assembly**

- 15"
- Threaded rod attaches to door
- Extends from main arm

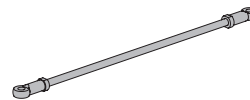

**9550-79LR
Linkage Assembly**

- 32"
- Threaded long rod attaches to door
- Extends from main arm
- Used for reveal 10" to 20"

Track



**9550-3038
Track**

- Non-handed
- Standard



**9550-73
Track End Cap**

- Black plastic end caps



**9550-3034
Roller**

- Quiet low friction roller assembly

Accessories

Brackets



- 9550-275 Mounting Bracket**
- Motor gearbox mounting bracket for 2 3/4" offset pivot or butt hinge installations
 - Front bracket



- 9550-3018 Rear Mounting Bracket**
- Motor gearbox mounting bracket



- 9550-334-1 Angle Brackets (HLB)**
- Mounting bracket for surface applications (includes 2 mounting brackets)

Header

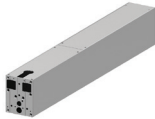

- 9550-3572HL Standard Mounting Header (HDR)**
- Pair door, two operators
 - Specify other length 52" to 98" (push)
 - Specify other length 54" to 98" (pull; double egress)
 - Standard

End cap



- 9550-334 Header End Caps**
- With openings for wiring



- 9550-334-2 Dress plates (HLD)**
- Metal finish end cap

Installation accessories



- 9550-11A Spindle Plate**
- Hides bottom of motor gearbox
 - Completes header box
 - Cutout allows for motor gearbox shaft
 - For 2 3/4" offset pivot or butt hinge installations



- 9550-12 Filler Plate**
- Blank
 - Completes length of header box
 - Specify length

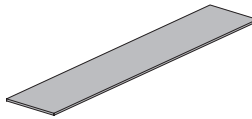

- 9550-18 Mounting Plate**
- Optional mounting plate for standard hollow metal door frames
 - Specify length 68 1/2" to 101 1/2" maximum when using angle brackets
 - Specify length 65" to 98" maximum when using dress plates
- Note: The length of a universal 18 plate will need to be ordered 3 1/2" longer than the supplied header when using angle brackets.

Introduction
 Product selection guide
 Pneumatic systems / Auto equalizers / 2610/4810/4820/4840/7900 Series
 Electrohydraulic systems / Auto equalizers / 4630/4640 Series
 Electromechanical systems / Benchmark / 9130/9140/9150 Series
 Electromechanical systems / Senior Swing / 2810/2850/2860/9530/9540/9550/9560 Series
 Actuators and accessories

Ordering information

How-to-order 9550 Series operators

1. Specify hand

- Right hand (RH)
- Left hand (LH)

2. Specify header/length

- Standard Mounting Header (HDR)
(Specify length 52" to 98" regular or long arm)
- Standard Mounting Header (HDR)
(Specify length 60" to 98" for standard or DE arm)

3. Select finish

- Standard anodized finish _____
Aluminum, Clear Anodized (628) or
Dark Bronze, Anodized (710).

Operator will be shipped with:

- Standard motor gearbox (SF) (2 ea)
- Standard control box (SC)
- Metal cover (at specified length - 72" standard)
- Regular arm (2 ea)
- 2 3/4" pivot point
- Machine screws
(unless options listed below are selected)

Operator options

Mounting plate

- Plate, ___ (Specify Length 52" to 101 1/2")

Arm

- Standard Arm Assembly with track roller (Handed) (STDTRKARM2)
- Regular Arm and 1 Standard Arm (Double Egress) (REGSTDDE)
- Long Arm (LONG)

Table of sizes

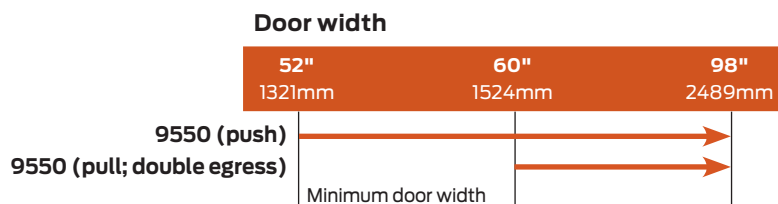

→ Indicates recommended range of door width for operator.
 Note: For all Senior Swing Series, Simultaneous Pair – Width per leaf 26" minimum (push) 30" minimum (pull) to 48" maximum.

9560 Series



The 9560 Senior Swing by LCN is an ADA door operator that is a two-in-one swing door operator. Senior swing operator when activated, opens doors automatically for wheelchair access, yet allows for manual operation for regular pedestrian traffic.

Features

Certifications	Grade 1 - ANSI A156.19, UL325/228, UL1998, ADA, 100 Hour Salt Spray, Meets BAA - Buy American Act
Handing	Handed
Warranty	2 years
Cover	Metal Cover (MC)

Fasteners	Machine Screws (MS)
Mounting	Independent pair, surface, pull, push, double egress
Arms	Single lever (push side), double lever (Pull side), double egress (push/pull)
Finishes/colors/ powder coat	<ul style="list-style-type: none"> ▪ 628 Aluminum, Anodized ▪ 710 Dark Brown, Anodized

Special templates | Customized installation templates or products may be available to solve non-standard applications. Contact LCN Product Support for assistance.

Mounting	Handing	Finish	Cover	Arm function
Surface mount single door	Handed	Standard anodized	Standard (single lever)	Single lever (push side)
Surface mount simultaneous pair	Non-handed	Metal	Regular (double lever)	Double lever (Pull side)
Surface mount independent pair			Double egress (push/pull)	Double egress (push/pull)
Concealed single door			Offset pivot arm	Offset pivot arm
Concealed simultaneous pair			Center pivot arm	Center pivot arm
Concealed independent pair				

■ Available
■ Not available

Introduction
 Product selection guide
 Pneumatic systems / Auto equalizers / 2610/4810/4820/4840/7900 Series
 Electrohydraulic systems / Auto equalizers / 4630/4640 Series
 Electromechanical systems / Benchmark / 9130/9140/9150 Series
 Electromechanical systems / Senior Swing / 2810/2850/2860/9530/9540/9550/9560 Series
 Actuators and accessories

Mounting details

Top jamb independent pair mounting

Offset pivot/butt hinge, center pivot, push

Note: Consult factory for all balanced door installations.

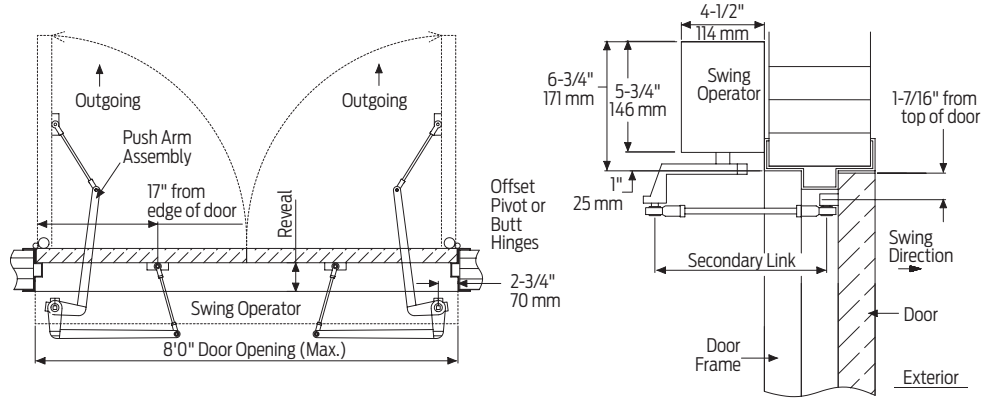

Offset pivot/ butt hinge, center pivot, pull

Note: Cannot be used with swing clear hinges, pocket pivots or balanced doors.

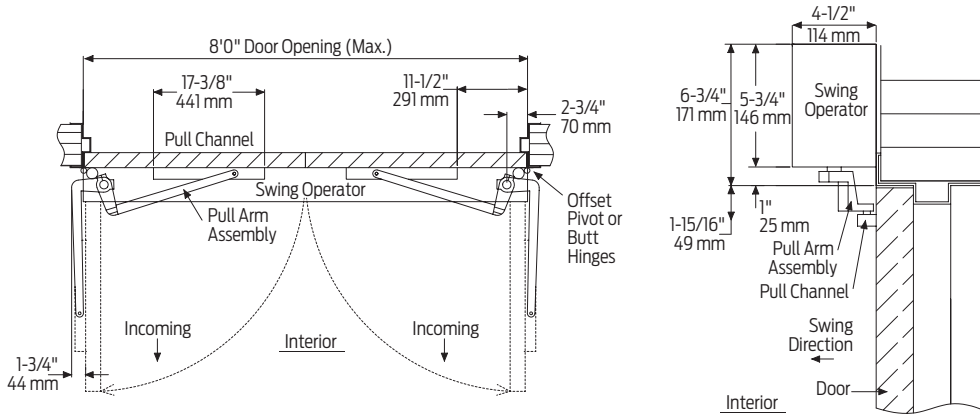

Butt hinges	Should not exceed 5" (127 mm) in width
Reveal for push	Should not exceed 10" (254 mm) for Regular Arm and 20" (508 mm) for Long Arm
Reveal for pull	Should not exceed 4" (102 mm)
Reveal	Double egress installations should not exceed 4" (102 mm)
Top rail	Minimum 2 3/4" (70 mm)
Head frame	<ul style="list-style-type: none"> Minimum 1 3/4" (44 mm) Face frame 6 3/4" (171 mm) total operator clearance
Opening and closing time	<ul style="list-style-type: none"> Variable by adjustments to the electronic control box Maximum hold open time adjustable up to approximately 32 seconds
System diagram	See pages 45 for typical system wiring and page 44 for electrical data
Maximum opening	Template allows 90 degree power opening and 90 degree manual opening

Notes:

- Push N' Go permits non-switch activation with a power boost providing additional latching force
- Electromechanical unit with microprocessor control
- Digital keypad for easy setup
- 72" header length is standard. Specify 65" - 98" max
- Pull, push, or double egress applications available
- Actuators available separately, see pages 100-117

Mounting details

Top jamb independent pair mounting

RH double egress

Note: Cannot be used with swing clear hinges, pocket pivots or balanced door.

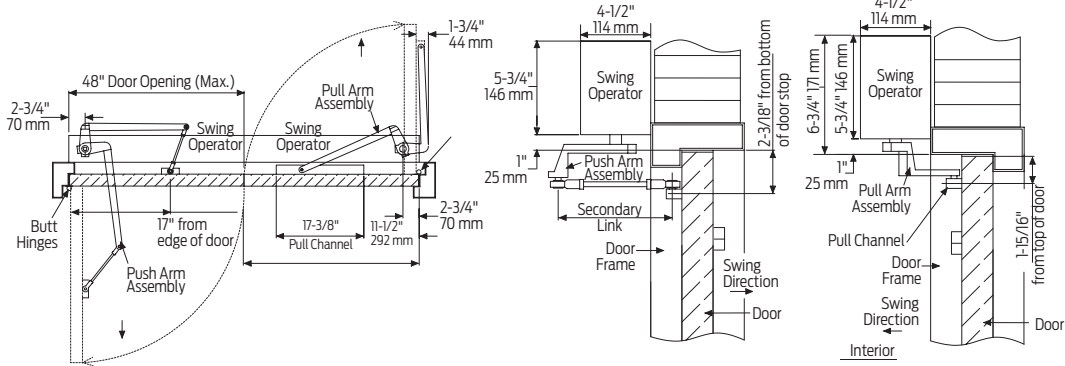

Hollow metal frame

The 18 plate is 1/4" thick and will need to be ordered 3 1/2" longer than the header to allow for mounting the angle brackets to the vertical side jambs. See illustration below.

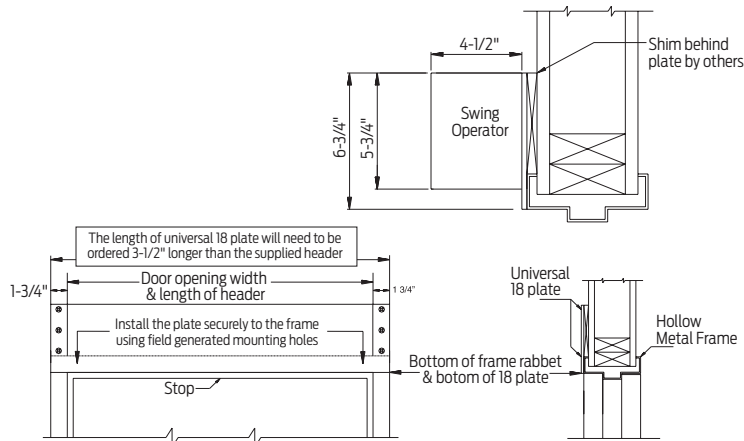

Note: Suggested installation.

Butt hinges	Should not exceed 5" (127 mm) in width
Reveal for push	Should not exceed 10" (254 mm) for Regular Arm and 20" (508 mm) for Long Arm
Reveal for pull	Should not exceed 4" (102 mm)
Reveal	Double egress installations should not exceed 4" (102 mm)
Top rail	Minimum 2 3/4" (70 mm)
Head frame	<ul style="list-style-type: none"> Minimum 1 3/4" (44 mm) Face frame 6 3/4" (171 mm) total operator clearance
Opening and closing time	<ul style="list-style-type: none"> Variable by adjustments to the electronic control box Maximum hold open time adjustable up to approximately 32 seconds
System diagram	See pages 45 for typical system wiring and page 44 for electrical data
Maximum opening	Template allows 90 degree power opening and 90 degree manual opening

Notes:

- Push N' Go permits non-switch activation with a power boost providing additional latching force
- Electromechanical unit with microprocessor control
- Digital keypad for easy setup
- 72" header length is standard. Specify 65" - 98" max
- Pull, push, or double egress applications available
- Adjustable hold open period of 2 - 32 seconds in automatic or manual mode
- Actuators available separately, see pages 100-117

Introduction
 Product selection guide
 Pneumatic systems Auto equalizers 2610/4810/4820/4840/7900 Series
 Electrohydraulic systems Auto equalizers 4630/4640 Series
 Electromechanical systems Benchmark 9130/9140/9150 Series
 Electromechanical systems Senior Swing 2810/2850/2860/9530/9540/9550/9560 Series
 Actuators and accessories

Accessories

Motor gearbox

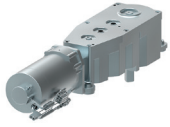

**9560-3454
Standard Motor Gearbox (MGB)**

- Senior Swing
- Handed
- Driving mechanism for operator
- Provides maximum 15 lbs opening force

Control box

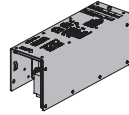

**9560-3462
Standard Controller (CTRL)**

- Electronic controlling device for Senior Swing

Arm



**9560-3077T
Standard Arm (STDTRKARM)**

- Handed
- Track roller not included

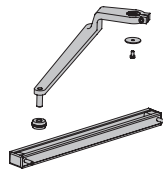

**9560-3077
Regular Arm (REGARM)**

- Handed
- Includes 77 main arm assembly and 79 linkage assembly

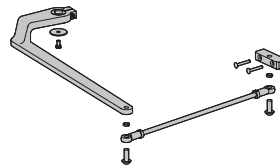

**9560-3077L
Long Arm (LONG)**

- Handed
- Includes 77 main arm assembly and 79LR linkage assembly



**9560-3077PLCM
Standard Arm Assembly with Track Roller (STDTRKARM2)**

- Handed
- Includes 3077 regular arm assembly, 3038 track, and 3034 track roller

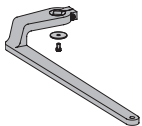

**9560-77
Main Arm**

- Handed
- Attaches to motor gearbox

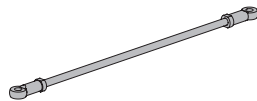

**9560-79
Linkage Assembly**

- 15"
- Threaded rod attaches to door
- Extends from main arm
- Used for reveal 1" to 10"

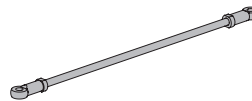

**9560-79LR
Linkage Assembly**

- 32"
- Threaded long rod attaches to door
- Extends from main arm
- Used for reveal 10" to 20"

Track



**9560-3038
Track**

- Non-handed
- Standard



**9560-73
Track End Cap**

- Black plastic end caps



**9560-3034
Roller**

- Quiet low friction roller assembly

Accessories

Brackets



**9560-275
Mounting Bracket**

- Motor gearbox mounting bracket for 2 3/4" center pivot installations
- Front bracket



**9560-3018
Rear Mounting Bracket**

- Motor gearbox mounting bracket



**9560-334-1
Angle Brackets (HLB)**

- Mounting bracket for surface applications
- Includes 2 mounting brackets

Header

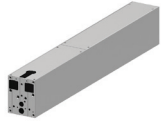

**9560-3572HL
Standard Mounting Header (HDR)**

- Pair door, two operators
- Specify length 65" to 98" maximum
- Standard

End cap



**9560-334
Header End Caps**

- With openings for wiring



**9560-334-2
Dress plates (HLD)**

- Metal finish end cap

Installation accessories



**9560-11A
Spindle Plate**

- Hides bottom of motor gearbox
- Completes header box
- Cutout allows for motor gearbox shaft
- For 2 3/4" offset pivot or butt hinge installations



**9560-12
Filler Plate**

- Blank
- Completes length of header box
- Specify length



**9560-18
Mounting Plate**

- Optional mounting plate for standard hollow metal door frames
- Specify length 68 1/2" to 101 1/2" maximum when using angle brackets
- Specify length 65" to 98" maximum when using dress plates

Note: The length of a universal 18 plate will need to be ordered 3 1/2" longer than the supplied header when using angle brackets.

Ordering information

How-to-order 9560 Series operators

1. Specify hand

- Right hand (RH)
- Left hand (LH)

2. Specify header/length

- Standard Mounting Header (HDR)
(Specify length 65" to 98" regular or long arm)

3. Select finish

- Standard anodized finish _____
Aluminum, Clear Anodized (628) or
Dark Bronze, Anodized (710).

Operator will be shipped with:

- Standard motor gearbox (SF) (2 ea)
- Standard control box (SC)
- Metal cover (at specified length - 72" standard)
- Regular arm (2 ea)
- 2 3/4" pivot point
- Machine screws
(unless options listed below are selected)

Operator options

Mounting plate

- Plate, ___ (Specify Length 65" to 101 1/2")

Arm

- Standard Arm Assembly with track roller (Handed) (STDTRKARM2)
- Regular Arm and 1 Standard Arm (Double Egress) (REGSTDDE)
- Long Arm (LONG)

Table of sizes

Door width



→ Indicates recommended range of door width for operator.
Note: For all Senior Swing Series. Independent pair – Width per leaf 30" minimum to 48" maximum.

Actuators and accessories

The actuators and accessories on the following pages are to be used with LCN automatic operators. When using actuators supplied by others, such as card readers, consult the factory. The desired function, traffic patterns and physical design of the opening will determine the type of actuators used. Generally, for two-way traffic, an actuator is required on both the interior and exterior side of the door. Each actuator is packaged with a decal to be applied to the controlled door. Scanners operate on 12V or 24V AC/DC and may be powered by the LCN electrohydraulic/electromechanical operators. The 7900 series control box requires separate power supply for scanners. Actuators provide normally open (N.O.) dry contacts.

4 1/2" Surface and flush mounts



- 8310-856**
Hard Wired Wall Mount, Logo
- Hardwired low voltage actuator with round, stainless steel touch plate in 4 1/2" (114mm) diameter
 - Engraved blue filled handicap symbol conforms to most accessibility codes
 - Designed to mount in a flush or surface mount box (sold separately) in/on a vertical surface near the controlled door
 - Optional mounting in single gang electrical box (by others)
 - Heavy industrial grade components provide vandal resistant mounting and weather resistant switch standard



- 8310-856T**
Hard Wired Wall Mount, Logo and Text
- Same as the 8310-856, with the added engraving of "Push to Open"

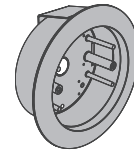

- 8310-868F**
Flush Mount Box
- Rugged Plastic Box, 4 1/2" Round
 - Optional accessory - can be used w/ any 4 1/2" round actuator

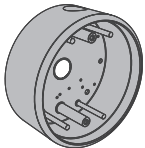

- 8310-868S**
Surface Mount Box
- Rugged Plastic Box, 4 1/2" Round
 - Optional accessory - can be used w/any 4 1/2" round actuator

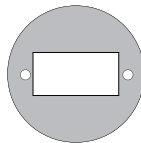

- 8310-800**
Weather/Trim Ring
- Weather/Trim Ring, 4 1/2" Round
 - Optional accessory - must be used w/any 4 1/2" round plastic mounting box

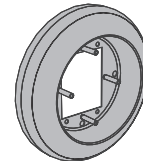

- 8310-874**
Escutcheon
- Tapered stainless steel escutcheon covers the gap between the wall and the back of the wall plate actuators when mounted in electrical boxes (by others) to minimize cart damage or vandalism
 - Optional accessory - can be used w/any 4 1/2" round actuator
 - Not to be used with wireless function

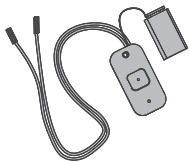

- 8310-844**
Transmitter, Wireless, 1 Channel, Wall Mount, 9V
- Transmitter, Wireless, 1 Channel, 9V battery included
 - Use to convert standard wall mount actuator to wireless
 - Requires 8310-865 Receiver

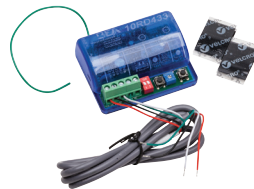

- 8310-865**
Wireless Receiver
- Receiver, Wireless, 1 Channel, w/Sequencing Feature
 - Used in conjunction w/ Wireless Actuators and Transmitter(s) for push plate applications

4 1/2" Surface and flush mounts

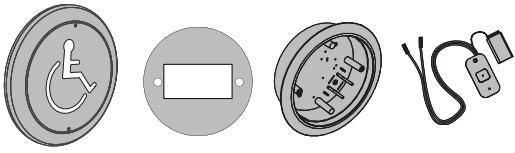

8310-3856WF

Wireless Actuator, Wall Mount and Flush, Logo, 4 1/2 inch round

- Actuator, 4 1/2" Round, Logo, Wireless
- Includes 8310-856 Actuator, 8310-844 Transmitter, 8310-868F Flush Box, 8310-800 Weather/Trim Ring
- Requires 8310-865 Receiver (not part of kit)

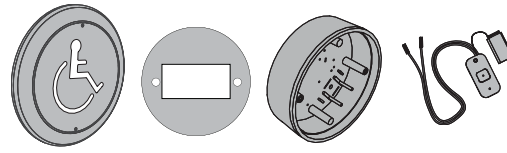

8310-3856WS

Wireless Actuator, Wall Mount and Surface, Logo, 4 1/2 inch round

- Actuator, 4 1/2" Round, Logo, Wireless
- Includes 8310-856 Actuator, 8310-844 Transmitter, 8310-868S Surface Box, 8310-800 Weather/Trim Ring
- Requires 8310-865 Receiver (not part of kit)

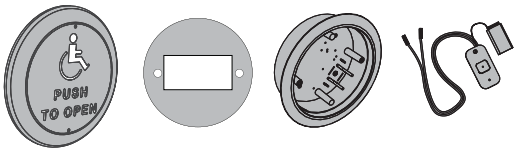

8310-3856TWF

Wireless Actuator, Wall Mount and Flush, Logo and Text, 4 1/2 inch round

- Actuator, 4 1/2" Round, Logo, Text, Wireless,
- Includes 8310-856T Actuator, 8310-844 Transmitter, 8310-868F Flush Box, 8310-800 Weather/Trim Ring
- Requires 8310-865 Receiver (not part of kit)

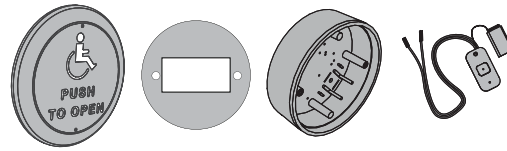

8310-3856TWS

Wireless Actuator, Wall Mount and Surface, Logo and Text, 4 1/2 inch round

- Actuator, 4 1/2" Round, Logo, Text, Wireless
- Includes 8310-856T Actuator, 8310-844 Transmitter, 8310-868S Surface Box, 8310-800 Weather/Trim Ring
- Requires 8310-865 Receiver (not part of kit)

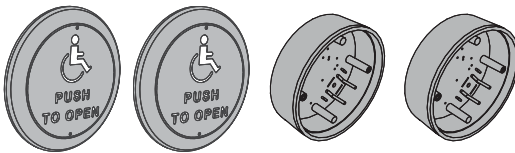

8310-3860T

Hard Wired Actuator Package, Logo and Text, 4 1/2 inch round

- Actuator Package, 4 1/2" Round
- Includes 8310-856T (2) Wall Mount Actuator, 8310-868S Surface Mount Box

Note: Weather/Trim Rings are sold separately.

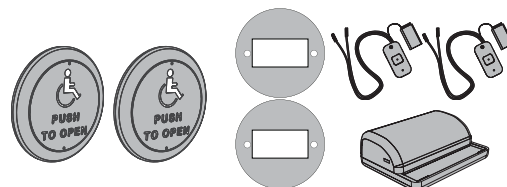

8310-3860TW

Hard Wired Actuator Package, Logo and Text, 4 1/2 inch round

- Includes 8310-856T (2) Wall Mount Actuator, 8310-868S (2) Surface Mount Box, 8310-800 (2) Weather/Trim Ring, 8310-844 (2) Transmitter, 8310-865 Receiver

6" Surface and flush mounts



- 8310-852**
Hard Wired Wall Mount Actuator, Logo, 6 inch round
- Hardwired low voltage actuator with round, stainless steel touch plate in 6" (152mm) diameter
 - Engraved blue filled handicap symbol conforms to most accessibility codes
 - Designed to mount in a flush or surface mount box (sold separately) in/on a vertical surface near the controlled door
 - Optional mounting in single gang electrical box (by others) or double gang box (4" x 4" by others)
 - Heavy industrial grade components provide vandal resistant mounting and weather resistant switch standard.



- 8310-852WP**
Wireless Wall Mount Actuator Package, Logo, 6 inch round
- Wireless, low profile, low voltage actuator with round, stainless steel touch plate in 6" (152mm) diameter
 - Engraved blue filled handicap symbol conforms to most accessibility codes
 - Surface mount box includes integral transmitter w/battery and actuator switch
 - Heavy industrial grade components provide vandal resistant mounting and weather resistant switch standard
 - Requires 8310-865 Receiver



- 8310-852T**
Hard Wired Wall Mount Actuator, Logo and Text, 6 inch round
- Same as the 8310-852, with the added engraving of "Push to Open"



- 8310-852TWP**
Wireless Wall Mount Actuator Package, Logo and Text, 6 inch round
- Same as the 8310-852WP, with the added engraving of "Push to Open"

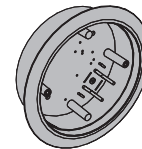

- 8310-869F**
Flush Mount Box
- Rugged Plastic Box, 6" Round
 - Optional accessory - can be used w/any 6" round actuator

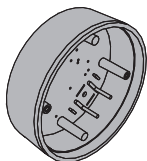

- 8310-869S**
Surface Mount Box
- Rugged Plastic Box, 6" Round
 - Optional accessory - can be used w/any 6" round actuator



- 8310-802**
Weather/Trim Ring
- Plastic Weather/Trim Ring, 6" Round
 - Optional accessory - can be used w/ any 6" round plastic mounting box

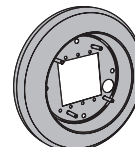

- 8310-876**
Escutcheon
- Tapered stainless steel escutcheon covers the gap between the wall and the back of the wall plate actuators when mounted in electrical boxes (by others) to minimize cart damage or vandalism
 - Optional accessory - Can be used w/any 6" round actuator
 - Not to be used with wireless function

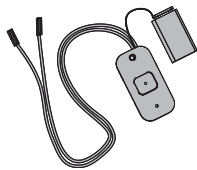

- 8310-844**
Transmitter, Wireless, 1 Channel, Wall Mount, 9V
- Transmitter, Wireless, 1 Channel, 9V battery included
 - Use to convert standard wall mount actuator to wireless
 - Requires 8310-865 Receiver

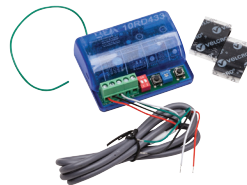

- 8310-865**
Wireless Receiver
- Receiver, Wireless, 1 Channel, w/ Sequencing Feature
 - Used in conjunction w/ Wireless Actuators and Transmitter(s) for push plate applications

6" Surface and flush mounts

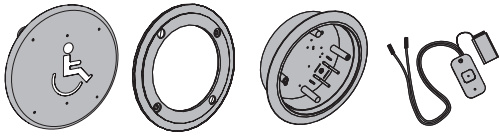

8310-3852WF

Wireless Actuator, Wall Mount and Flush, Logo, 6 inch round

- 6" Round, Logo, Wireless
- Includes 8310-852 Actuator, 8310-844 Transmitter, 8310-869F Flush Box, 8310-802 Weather/Trim Ring
- Requires 8310-865 Receiver (not part of kit)

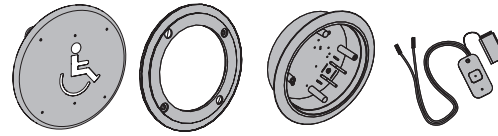

8310-3852WS

Wireless Actuator, Wall Mount and Surface, Logo, 6 inch round

- 6" Round, Logo, Wireless,
- Includes 8310-852 Actuator, 8310-844 Transmitter, 8310-869S Surface Box, 8310-802 Weather/Trim Ring
- Requires 8310-865 Receiver (not part of kit)

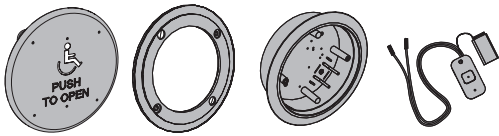

8310-3852TWF

Wireless Actuator, Wall Mount and Flush, Logo and Text, 6 inch round

- 6" Round, Logo, Text, Wireless,
- Includes 8310-852T Actuator, 8310-844 Transmitter, 8310-869F Flush Box, 8310-802 Weather/Trim Ring
- Requires 8310-865 Receiver (not part of kit)

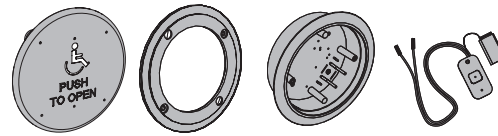

8310-3852TWS

Wireless Actuator, Wall Mount and Surface, Logo and Text, 6 inch round

- 6" Round, Logo, Text, Wireless
- Includes 8310-852T Actuator, 8310-844 Transmitter, 8310-869S Surface Box, 8310-802 Weather/Trim Ring
- Requires 8310-865 Receiver (not part of kit)

1 1/2" x 4 3/4" Surface and flush mounts

**8310-818****Hard Wired Jamb Mount Actuator, Logo, 1 1/2" x 4 3/4"**

- Hardwired low voltage actuator with rectangular stainless steel touch plate
- 1 1/2" (38mm) wide by 4 3/4" (121mm)
- Engraved blue filled handicap symbol conforms to most accessibility codes
- Designed to mount in a frame cutout (template provided) projecting approximately 1/2" (12mm) from the frame
- Optional mounting in surface or flush mount box (sold separately)
- Heavy industrial grade components provide vandal resistant mounting and weather resistant switch standard

**8310-818T****Hard Wired Jamb Mount Actuator, Logo and Text, 1 1/2" x 4 3/4"**

- Same as the 8310-818, with the added engraving of "Push to Open"

**8310-819F****Box Only, Jamb Mount and Flush Mount, 1 1/2" x 4 3/4"**

- Rugged Plastic Jamb Box
- 1 1/2" x 4 3/4" rectangle, optional accessory - can be used w/any 1 1/2" x 4 3/4" jamb mount actuator

**8310-819S****Box Only, Jamb Mount and Surface Mount, 1 1/2" x 4 3/4"**

- Rugged Plastic Jamb Box
- 1 1/2" x 4 3/4", rectangle
- Optional accessory - can be used w/any 1 1/2" x 4 3/4" jamb mount plastic mounting box

**8310-844J****Transmitter, Wireless, 1 Channel, Jamb Mount, 3V**

- Wireless, 1 Channel, Jamb Mount, 3v battery included
- Used to convert standard jamb mount actuator to wireless when used w/819F or 819S boxes; requires 8310-865 Receiver (interior use only)

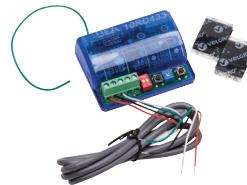
**8310-865****Wireless Receiver**

- Receiver, Wireless, 1 Channel, w/ Sequencing Feature
- Used in conjunction w/ Wireless Actuators and Transmitter(s) for push plate applications

Note: LCN recommends for all jamb mount actuators be used on an interior installation only.

Actuators and accessories

1 1/2" x 4 3/4" Surface and flush mounts

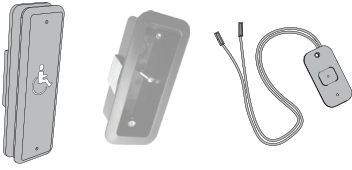
8310-3818WF
Wireless Actuator, Jamb Mount and Flush, Logo,
1 1/2" x 4 3/4"

- Actuator, 1 1/2" x 4 3/4" Rectangle, Logo, Wireless
- Includes 8310-818 Actuator, 8310-844J Transmitter, 8310-819F Flush Box
- Requires 8310-865 Receiver (not part of kit)

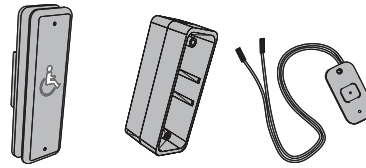
8310-3818WS
Wireless Actuator, Jamb Mount and Surface, Logo,
1 1/2" x 4 3/4"

- Actuator, 1 1/2" x 4 3/4" Rectangle, Logo, Wireless
- Includes 8310-818 Actuator, 8310-844J Transmitter, 8310-819S Surface Box
- Requires 8310-865 Receiver (not part of kit)

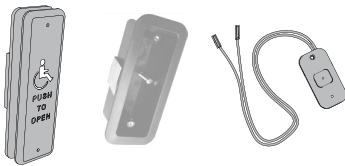
8310-3818TWF
Wireless Actuator, Jamb Mount and Flush, Logo and Text,
1 1/2" x 4 3/4"

- Actuator, 1 1/2" x 4 3/4" Rectangle, Logo, Wireless
- Includes 8310-818T Actuator, 8310-844J Transmitter, 8310-819F Flush Box
- Requires 8310-865 Receiver (not part of kit)

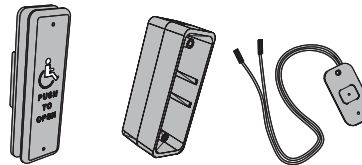
8310-3818TWS
Wireless Actuator, Jamb Mount and Surface, Logo and Text,
1 1/2" x 4 3/4"

- Actuator, 1 1/2" x 4 3/4" Rectangle, Logo, Wireless
- Includes 8310-818T Actuator, 8310-844J Transmitter, 8310-819S Surface Box
- Requires 8310-865 Receiver (not part of kit)

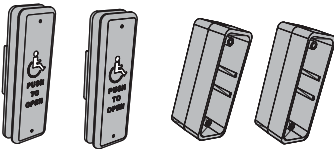
8310-3822T
Hard Wired Actuator Package, Logo and Text,
1 1/2" x 4 3/4"

- Actuator Package, 1 1/2" x 4 3/4", Jamb Mount
- Includes 8310-818T (2) Jamb Mount Actuator, 8310-819S (2)
- Surface Mount Box

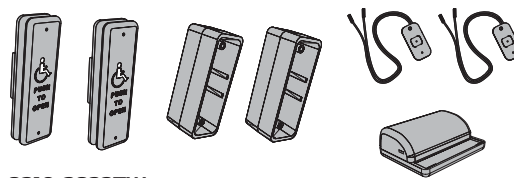
8310-3822TW
Wireless Actuator Package, Logo and Text,
1 1/2" x 4 3/4"

- Actuator Package, 1 1/2" x 4 3/4", Wireless, Jamb Mount
- Includes 8310-818T (2) Jamb Mount Actuator, 8310-819S (2)
- Surface Mount Box, 8310-844J (2) Jamb Mount Transmitter, 8310-865 Receiver

Note: LCN recommends for all jamb mount actuators be used on an interior installation only.

4 3/4" Square surface and flush mounts



8310-853

Hard Wired Wall Mount, Logo, 4 3/4" x 4 3/4"

- Hardwired low voltage actuator with stainless steel touch plate in 4 3/4" (121mm) square
- Engraved blue filled handicap symbol conforms to most accessibility codes
- Designed to mount in a flush or surface mount box (sold separately) in/on a vertical surface near the controlled door
- Optional mounting in single gang electrical box (by others) or double gang box (4" x 4" by others) or on an 8310-866 bollard post
- Heavy industrial grade components provide vandal resistant mounting and weather resistant switch standard



8310-853WP

Wireless Wall Mount Actuator Package, Logo, 4 3/4" x 4 3/4"

- Wireless, low profile, low voltage actuator with square, stainless steel touch plate in 4 3/4" (121mm) square
- Engraved blue filled handicap symbol conforms to most accessibility codes
- Surface mount box includes integral transmitter w/battery and actuator switch
- Heavy industrial grade components provide vandal resistant mounting and weather resistant switch standard
- Requires 8310-865 Receiver



8310-853T

Hard Wired Wall Mount, Logo and Text, 4 3/4" x 4 3/4"

- Same as the 8310-853, with the added engraving of "Push to Open"



8310-853TWP

Wireless Wall Mount Actuator Package, Logo and Text, 4 3/4" x 4 3/4"

- Same as the 8310-853WP, with the added engraving of "Push to Open"

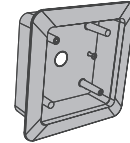

8310-867F

Flush Mounted Actuator

- Rugged Plastic Box, 4 3/4" Square
- Optional accessory - can be used w/any 4 3/4" square actuator

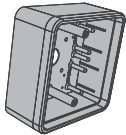

8310-867S

Surface Mount Box

- Rugged Plastic Box, 4 3/4" Square
- Optional accessory - can be used w/any 4 3/4" square actuator

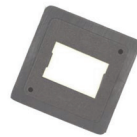

8310-801

Weather/Trim Ring

- Plastic Weather Ring, 4 3/4" Square
- Optional accessory - can be used w/any 4 3/4" square plastic mounting box

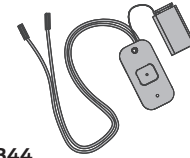

8310-844

Transmitter, Wireless, 1 Channel, Wall Mount, 9V

- Transmitter, Wireless, 1 Channel, 9V battery included
- Use to convert standard wall mount actuator to wireless
- Requires 8310-865 Receiver



8310-865

Wireless Receiver

- Receiver, Wireless, 1 Channel, w/Sequencing Feature
- Used in conjunction w/ Wireless Actuators and Transmitter(s) for push plate applications

Introduction
 Product selection guide
 Pneumatic systems
 Auto equalizers
 2610/4810/4820/4840/7900 Series
 Electrohydraulic systems
 Auto equalizers
 4630/4640 Series
 Electromechanical systems
 Benchmark
 9130/9140/9150 Series
 Electromechanical systems
 Senior Swing
 2810/2850/2860/9530/9540/9550/9560 Series
 Actuators and accessories

Actuators and accessories

4 3/4" Square surface and flush mounts

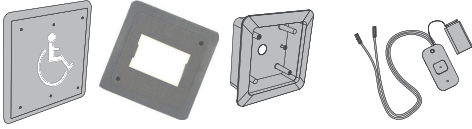
**8310-3853WF****Wireless Actuator, Wall Mount and Flush, Logo, 4 3/4" x 4 3/4"**

- Actuator, 4 3/4" Square, Logo, Wireless
- Includes 8310-853, 8310-844 Transmitter, 8310-867F Flush Box, 8310-801 Weather/Trim Ring
- Requires 8310-865 Receiver (not part of kit)

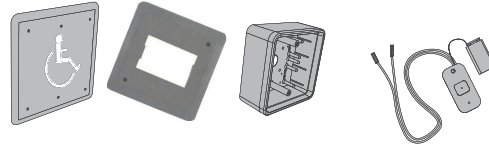
**8310-3853WS****Wireless Actuator, Wall Mount and Surface, Logo, 4 3/4" x 4 3/4"**

- Actuator, 4 3/4" Square, Logo, Wireless
- Includes 8310-853, 8310-844 Transmitter, 8310-867S Surface Box, 8310-801 Weather/Trim Ring
- Requires 8310-865 Receiver (not part of kit)

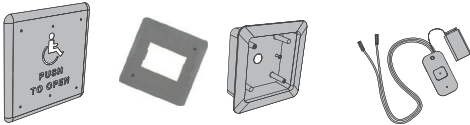
**8310-3853TWF****Hard Wired Actuator, Wall Mount and Flush, Logo and Text, 4 3/4" x 4 3/4"**

- Actuator, 4 3/4" Square, Logo, Text, Wireless
- Includes 8310-853T, 8310-844 Transmitter, 8310-867F Flush Box, 8310-801 Weather/Trim Ring
- Requires 8310-865 Receiver (not part of kit)

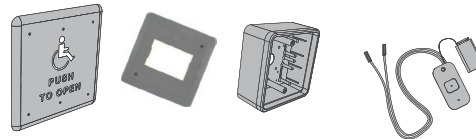
**8310-3853TWS****Hard Wired Actuator, Wall Mount and Surface, Logo and Text, 4 3/4" x 4 3/4"**

- Actuator, 4 3/4" Square, Logo, Text, Wireless
- Includes 8310-853T, 8310-844 Transmitter, 8310-867S Surface Box, 8310-801 Weather/Trim Ring
- Requires 8310-865 Receiver (not part of kit)

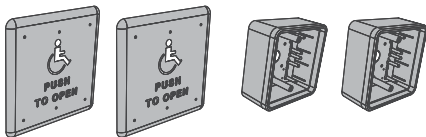
**8310-3857T****Hard Wired Actuator Package, Logo and Text, 4 3/4" x 4 3/4"**

- Actuator Package, 4 3/4" Square
- Includes 8310-853T (2) Wall Mount Actuator, 8310-867S (2) Surface Mount Box
- Surface Mount Box

Note: Weather/Trim Rings are sold separately

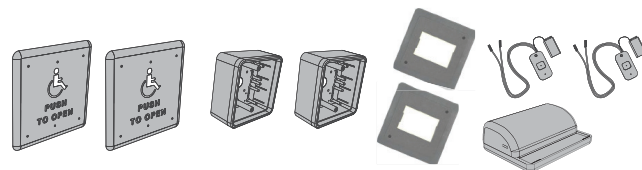
**8310-3857TW****Wireless Actuator Package, Logo and Text, 4 3/4" x 4 3/4"**

- Actuator Package, 4 3/4" Square
- Includes 8310-853T (2) Wall Mount Actuator, 8310-867S (2) Surface Mount Box, 8310-801 (2) Weather/Trim Ring, 8310-844 (2) Transmitter, 8310-865 Receiver

4 3/4" Dual square surface and flush mounts



8310-855

Hard Wired Wall Mount Actuator, Logo, Double Vestibule

- Hardwired low voltage actuator with dual rectangle, stainless steel touch plate in 4 3/4" (121mm) square
- Engraved blue filled handicap symbol w/text, conforms to most accessibility codes
- Designed to mount in a flush or surface mount box (sold separately) in/on a vertical surface near the controlled door
- Optional mounting in double gang box (4" x 4" by others) or on an 8310-866 bollard post
- Heavy industrial grade components provide vandal resistant mounting and weather resistant switch standard

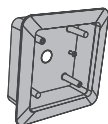

8310-867F

Flush Mounted Actuator

- Rugged Plastic Box, 4 3/4" Square
- Optional accessory - can be used w/any 4 3/4" square actuator

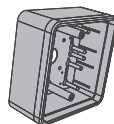

8310-867S

Surface Mount Box

- Rugged Plastic Box, 4 3/4" Square
- Optional accessory - can be used w/any 4 3/4" square actuator

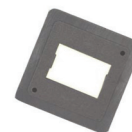

8310-801

Weather/Trim Ring

- Plastic Weather Ring, 4 3/4" Square
- Optional accessory - can be used w/any 4 3/4" square plastic mounting box

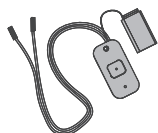

8310-844

Transmitter, Wireless, 1 Channel, Wall Mount, 9V

- Transmitter, Wireless, 1 Channel, 9V battery included
- Use to convert standard wall mount actuator to wireless
- Requires 8310-865 Receiver



8310-865

Wireless Receiver

- Receiver, Wireless, 1 Channel, w/Sequencing Feature
- Used in conjunction w/ Wireless Actuators and Transmitter(s) for push plate applications

4 3/4" Dual square surface and flush mounts

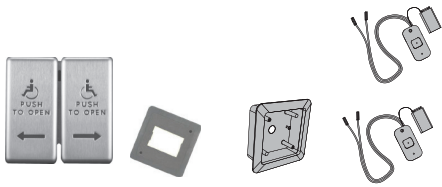

8310-3855WF

Wireless Actuator, Wall Mount and Flush, Dual Vestibule, Logo, 4 3/4" x 4 3/4"

- Actuator, 4 3/4" Square, Logo, Text, Dual Vestibule, Wireless
- Includes 8310-855 Actuator, 8310-844 Transmitter (2), 8310-867F Flush Box, 8310-801 Weather/Trim Ring
- Requires 8310-865 Receiver (2) (not part of kit)

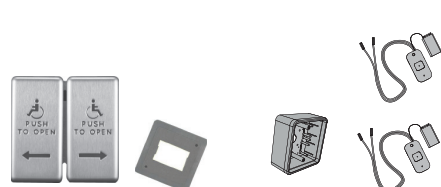

8310-3855WS

Wireless Actuator, Wall Mount and Surface, Dual Vestibule, Logo, 4 3/4" x 4 3/4"

- Actuator, 4 3/4" Square, Logo, Text, Dual Vestibule, Wireless
- Includes 8310-855 Actuator, 8310-844 Transmitter (2), 8310-867S Surface Box, 8310-801 Weather/Trim Ring
- Requires 8310-865 Receiver (2) (not part of kit)



8310-3853WB

Wireless Bollard Actuator, Logo, 4 3/4" Square

- 4 3/4" Square/Logo, Wireless actuator
- Use w/ 8310-866 Bollard (not included)
 - Includes 8310-853 actuator, 8310-844 transmitter
- Requires 8310-865 Receiver (not part of kit)

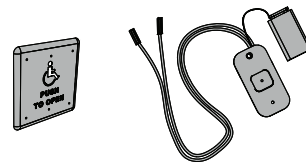

8310-3853TWB

Wireless Bollard Actuator, Logo and Text, 4 3/4" Square

- 4 3/4" Square w/Logo, Wireless actuator
- Use w/8310-866 Bollard (not included) - Includes 8310-853T actuator, 8310-844 Transmitter
- Requires 8310-865 Receiver (not part of kit)

36" x 6" Full length actuators



8310-836T

Hard Wired Full Length Actuator, Logo and Text, 36" x 6"

- Hardwired low voltage actuator with stainless steel touch plate with 36" x 6" activation surface
- Blue handicap symbol conforms with most accessibility codes
- Added "PUSH TO OPEN" lettering for enhanced identification
- Designed to meet California building codes and increase accessibility for wheelchair bound entrants
- Can easily be mounted to any flat surface or a bollard post



8310-836TW

Wireless Full Length Actuator, Logo and Text, 36" x 6"

- Same as the 8310-836T with a built in wireless transmitter and 3v battery
- Use in conjunction with 8310-865 Receiver (not included)



8310-866FLA FLA Bollard Post

- A powder coated steel 42" x 4" x 6": Bollard Post, mounting base pre prepped for the 8310-836T
- Includes 8310-866CAP, 2 mounting screws and spacer for installation

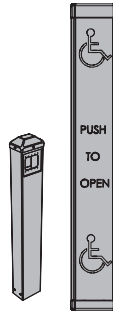

8310-3836T Full Length Actuator/Bollard Package

- 36" x 6" Actuator with 8310- 866FLA Bollard for wired applications

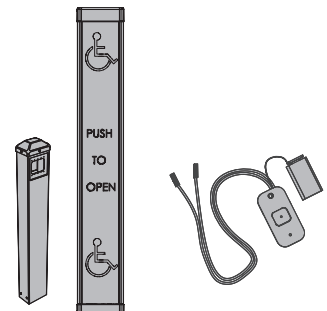

8310-3836TW Wireless Full Length Actuator/ Bollard Package

- 36" x 6" Actuator with 8310-866FLA Bollard and 8310-844 wireless transmitter
- Transmitter requires 8310-865 Receiver (not included)

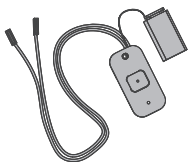

8310-844 Transmitter, Wireless, 1 Channel, Wall Mount, 9V

- Transmitter, Wireless, 1 Channel, 9V battery included
- Use to convert standard wall mount actuator to wireless
- Requires 8310-865 Receiver



8310-865 Wireless Receiver

- Receiver, Wireless, 1 Channel, w/Sequencing Feature
- Used in conjunction w/ Wireless Actuators and Transmitter(s) for push plate applications

Touchless actuators



- 8310-810D**
Touchless Actuator, Double Gang
- Stainless steel
 - 2 - 24" range
 - Heavy duty applications
 - Compatible with -880 receiver



- 8310-810R**
Touchless Actuator, Round
- Stainless steel
 - 2 - 24" range
 - Heavy duty applications
 - Compatible with -880 receiver



- 8310-810S**
Touchless Actuator, Single Gang
- Stainless steel
 - 2 - 24" range
 - Heavy duty applications
 - Compatible with -880 receiver



- 8310-813**
Touchless Actuator, Single Gang and Double Gang
- Black: ASA, Nylon, PC
 - 4-24" Range
 - Medium duty applications
 - Compatible with -880 receiver



- 8310-813J**
Touchless Actuator, Jamb
- Black: ASA, Nylon, PC
 - 4-24" Range
 - Medium duty applications
 - Compatible with -880 receiver



- 8310-813JWH**
Touchless Actuator, Jamb
- White: ASA, Nylon, PC
 - 4-24" Range
 - Medium duty applications
 - Compatible with -880 receiver



- 8310-813R**
Touchless Actuator, Round
- Black: ASA, Nylon, PC
 - 4-24" Range
 - Medium duty applications
 - Compatible with -880 receiver



- 8310-813RWH**
Touchless Actuator, Round
- White: ASA, Nylon, PC
 - 4 - 24" range
 - Medium duty applications
 - Compatible with -880 receiver



- 8310-813WH**
Touchless Actuator, Single Gang and Double Gang
- White: ASA, Nylon, PC
 - 4-24" Range
 - Medium duty applications
 - Compatible with -880 receiver



- 8310-815**
Touchless Actuator, Square
- External Mounting Box not required
 - 4 - 24" range
 - Harsh condition applications
 - Compatible with -880 receiver



- 8310-816R**
Touchless Actuator, Round, 7"
- 0 - 4" range
 - Stainless steel
 - Proximity applications



- 8310-816S**
Touchless Actuator, Square, 6"
- 0 - 4" range
 - Stainless steel
 - Proximity applications

Touchless wireless receivers



8310-880
Wireless Receiver, 900 MHz

- Receiver, wireless
- Program instant or delayed actuation
- Used in conjunction with touchless actuators for wireless signal transmission



8310-881
900 MHz Transmitter, 1 Button

- Handheld transmitter
- 3V battery powered
- Line of sight ~500 ft



8310-882
900 MHz Transmitter, 2 Buttons

- Handheld transmitter
- 3V battery powered
- Line of sight ~500 ft



8310-883
900 MHz Transmitter, 3 Buttons

- Handheld transmitter
- 3V battery powered
- Line of sight ~500 ft



8310-884
900 MHz Transmitter, 4 Buttons

- Handheld transmitter
- 3V battery powered
- Line of sight ~500 ft

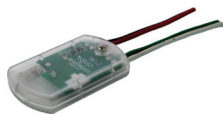

8310-885
Retrofit 900 MHz Transmitter

- Push plate conversion to touchless application
- Line of sight ~500 ft



8310-886
900 MHz Hardwired Transmitter

- 900 MHz transmitter for hardwired applications

Sensors

The sensors and accessories on the following pages are to be used only with LCN automatic operators. When using sensors supplied by others, consult the factory. The desired function, traffic patterns and physical design of the opening will determine the type of sensors used.

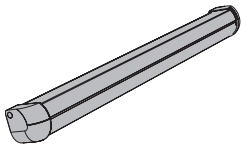

8310-804-1
(1) Door Mount Safety Sensor for Leading Edge

- Contains one active sensor module to detect obstruction(s) on leading edge of door

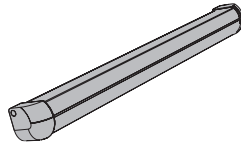

8310-804-2
(1) Door Mount Safety Sensor for Full Face

- Contains two active sensor modules to detect obstruction(s) on full face of door

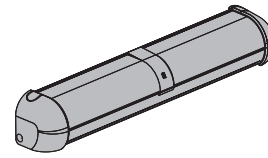

8310-877
(1) Header Mount Safety Sensor

- Safety Sensor, 'Diffused Infrared' Technology
- Used to detect obstructions during door open and door closed position
- Nine selectable patterns
- 8310-859 Handheld Remote Control required to program 8310-877 sensor from a distance
- Includes 8310-846 Harness



8310-877S
Header Mount Safety Sensor Spacer

- Required when 8310-804-1 or 8310-804-2 Door Mount Safety
- Spacers are used w/8310-877 Header Mount Safety Sensor



8310-859
Handheld Remote Control

- Used to program 8310-877 Header Mount Safety Sensor or 8310-854 Header Mount Motion Sensor



8310-846
Header Mount Harness

- Comes with 8310-877 Header Mount Safety Sensor



8310-847
Door Mount Harness

- Used with 8310-804-1 or 8310-804-2 Door Mount Safety Sensor, must order separately.
- Used with Senior Swing only, must order separately



8310-878
Single Door Safety Package - (2) Door Mounted Safety Sensors with ANSI .10 Monitoring

- Contains two door-mounted sensors and a control hub that perform the swing door safety functions and provides the sensor monitoring required by A156.10
- All wire harnesses and mounting hardware included



8310-879
Double Door Safety Package - (4) Door Mounted Safety Sensors with ANSI .10 Monitoring

- Contains four door-mounted sensors and a control hub that perform the swing door safety functions and provides the sensor monitoring required by A156.10
- All wire harnesses and mounting hardware included

Packages



8310-3881
Single Door Package - (1) Activation and (2) Safety Sensors with ANSI .10 Monitoring

- Activation/Safety Sensor Package, Single Door
- Includes 8310-854 (2) Header Mount Activation Sensor, 8310-878 Monitored Safety Sensor kit (Used with Senior Swing only)

Alert: After November 2017, this package must be purchased for unknowing-act activation requirements in A156.10 for single door.



8310-3883
Senior Swing Single Door Package - (1) Safety Sensor and (1) Concealed Door Position Switch and (1) Relay Module

- Activation/Safety Sensor Package, Low Energy Convenience
- Single Door, Includes 8310-804-1 Door Mount Safety Sensor (approach side), 8310-805C Door Position Switch (Concealed), 8310-845 Programmable Relay Module (Used with Senior Swing only)



8310-3882
Double Door Package - (2) Activation and (4) Safety Sensors with ANSI .10 Monitoring

- Activation/Safety Sensor Package, Double Door
- Includes 8310-854 (2) Header Mount Sensor, 8310-879 Monitored Safety Sensor kit (Used with Senior Swing only)

Alert: After November 2017, this package must be purchased for unknowing-act activation requirements in A156.10 for single door.

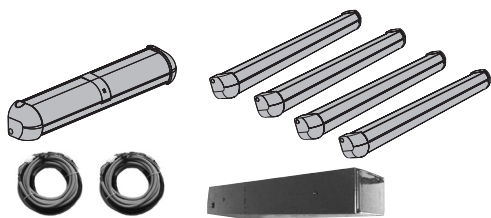

8310-3891
Senior Swing Simultaneous Pair Package - (1) Header Safety Sensor and (1) Spacer and (4) Door Mount Safety Sensors and (2) Harnesses

- Activation/Safety Sensor Package, Health Care I, Simultaneous Pair
- Includes 8310-877 Header Mount Sensor, 8310-877S Header Mount Spacer, 8310-804-2 (4) Door Mount Sensor (approach/ safety side), 8310-847 (2) Harness (Used with Senior Swing only)

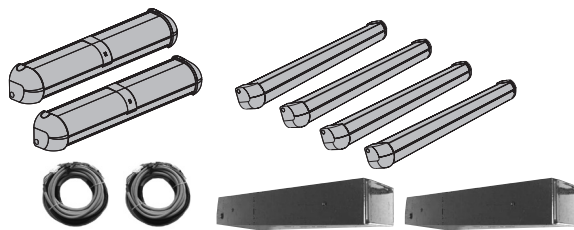

8310-3892
Senior Swing Independent Pair Package - (2) Header Sensors and (2) Spacers and (4) Door Safety Sensors and (2) Harnesses

- Activation/Safety Sensor Package, Health Care II, Independent Pair, Includes 8310-877 (2) Header Mount Sensor, 8310-877S (2) Header Mount Spacer, 8310-804-2 (4) Door Mount Sensor (approach/safety side), 8310-847 (2) Harness (Used with Senior Swing only)

NOTE: Not for use with Double Egress These two sensor packages must be used on installations with knowing-act activation only

Sensor accessories



- 8310-805**
Door Position Switch (DPS)
- Surface mount
 - Used when 8310-804-1 or 8310-804-2 Door Mounted Safety Sensor and 8310-845 Relay Module is installed in conjunction w/either a electrohydraulic, pneumatic or Benchmark Automatic Operator
 - Disables approach side sensor when door is closed



- 8310-805C**
Door Position Switch (DPS)
- Concealed
 - Used when 8310-804-1 or 8310-804-2 Door Mounted Safety Sensor and 8310-845 Relay Module is installed in conjunction w/either a electrohydraulic, pneumatic or Benchmark Automatic Operator
 - Disables approach side sensor when door is closed

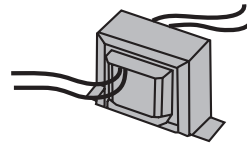

- 8310-824**
24V Hardwired Transformer
- Hardwired
 - Optional accessory - Used to remotely power any 24v sensor/receiver

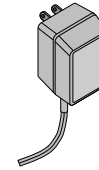

- 8310-824P**
24V Plug In Transformer
- 24v, plug in
 - Optional accessory - Used to remotely power any 24v sensor/receiver

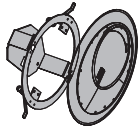

- 8310-854ECA**
Drop Ceiling Bracket
- Bracket used w/8310-854 Header Mount Activation Sensor
 - Optional

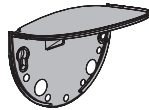

- 8310-854ERA**
Protective Cover
- Cover used w/8310-854 Header Mount Activation Sensor
 - Optional

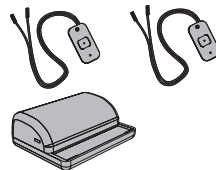

- 8310-3803**
3v Wireless Conversion Kit Jamb Mount
- Jamb mount, 3v
 - Converts standard jamb actuator to wireless version
 - Includes 8310-865 Receiver, 8310-844J (2) Jamb Mounted
 - Transmitter - Requires 8310-819S or 8310-819F Jamb Box

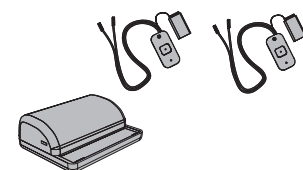

- 8310-3809**
9v Wireless Conversion Kit Wall Mount
- Jamb mount, 9v
 - Converts standard wall mount actuator to wireless version
 - Includes 8310-865 Receiver, 8310-844 (2) Wall Mount Transmitter
 - Requires Surface or Flush Box and Weather Ring



- 8310-3889**
Safety Module Kit for pneumatic control box
- Used w/7901, 7902, 7981, 7982 Control Boxes
 - Includes 8310-3888 Safety Module Harness; required when 8310-877 Header Mount Safety Sensor is used w/Pneumatic
 - Automatic Operators (2610, 4810, 4820 or 4840 Series)

- 8310-3888**
Safety Module Harness for pneumatic control box
- Safety module, service part
 - Safety Module Harness for pneumatic control box

Accessories



- 8310-861**
Transmitter, Wireless, 1 Channel, Handheld, 9v
- Wireless
 - 1 Channel, Handheld, 9v; requires 8310-865 Receiver



- 8310-862**
Transmitter, Wireless, 2 Channel, Handheld, 9v
- Wireless
 - 2 Channel, Handheld, 9v; requires 8310-865 Receiver



- 8310-863**
Transmitter, Wireless, 3 Channel, Handheld, 9v
- Wireless
 - 3 Channel, Handheld, 9v; requires 8310-865 Receiver



- 8310-864**
Transmitter, Wireless, 4 Channel, Handheld, 9v
- Wireless
 - 4 Channel, Handheld, 9v; requires 8310-865 Receiver



- 8310-866**
Bollard Post with Mounting Base and Actuator Cut-Out, 42" x 4" x 6"
- A powder coated steel 42" x 4" x 6" Bollard Post, Mounting Base and 8310-866CAP
 - Actuator cut out accepts 8310-3853WB or 8310-3853TWB wireless actuators 4 3/4" square hard wired actuator

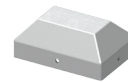

- 8310-866CAP**
Bollard Post Protective Cap
- Plastic Cap, Protective Cover, Service Part for 8310-866 Bollard Post

Sensor accessories



8310-806K Key Switch

- Type, 3 Position (On/Off/Hold Open)
- Optional switch used w/Senior Swing, Benchmark, or 4630/4640 operators with (CS) option

8310-806R Rocker Switch

- Type, 3 Position (On/Off/Hold Open)
- Optional switch used w/Senior Swing, Benchmark, or 4630/4640 operators with (CS) option



8310-845 Programmable Relay Module

- Used to sequence door operation in Senior Swing and Benchmark for hard wired applications

8310-807 Line Filter

- AC, 120v, Optional filter used w/Senior Operators to reduce 'line noise'

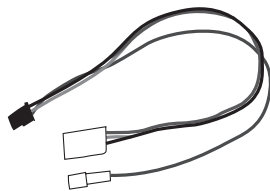

8310-887 Retrofit Cable

- Allows newer style Senior Swing digital control to be activated by existing switches when replacing older control purchased prior to September, 2006



8310-3134 Retrofit Cable Kit

- Allows newer style Senior Swing Digital Control to be activated by existing switches when replacing older control purchased prior to September, 2006
- Also includes cables to allow Safety Sensors to activate
- Includes 8310-887 plus Safety Sensor Cables

About Allegion

Allegion (NYSE: ALLE) is a global pioneer in seamless access, with leading brands like CISA®, Interflex®, LCN®, Schlage®, SimonsVoss® and Von Duprin®. Focusing on security around the door and adjacent areas, Allegion secures people and assets with a range of solutions for homes, businesses, schools and institutions. Allegion had \$2.9 billion in revenue in 2019 and sells products in almost 130 countries.

For more, visit www.allegion.com

KRYPTONITE ■ LCN ■  ■ STEELCRAFT ■ VON DUPRIN