



Product Bulletin

Brand/product: LCN

Date: October 4, 2022

Subject: October 2022 Price Book Updates

8310 Series Restroom Kits Added

Page 133: Added 8310-2410 Touchless Restroom Kit & 8310-2420 Push Plate Restroom Kit.



LCN[®]

Price book 12

Effective June 25, 2022 ▪ Rev. 10/22



Customer Care

Our Customer Care Representatives are available for questions or assistance.

877-671-7011

Customer service

☎ Press **1**
✉ support@allegion.com

Technical support

☎ Press **2**
✉ Closers_TechProdSupport@allegion.com

For new projects or to locate an authorized distributor

☎ Press **3**

Administrative offices

Allegion administrative office
11819 N. Pennsylvania St.
Carmel, IN 46032
allegion.com/us

Request for quote

Carolinas
(North Carolina, South Carolina, Virginia)
Carolinas.Quotes@allegion.com

Central
(Illinois, Iowa, Kansas, Missouri, Nebraska)
Central.Quotes@allegion.com

Chicago
(Northern Illinois, Wisconsin)
Chicago.Quotes@allegion.com

Florida
Florida.Quotes@allegion.com

Metro New York
(Metro New York, Northern New Jersey)
Metro.Quotes@allegion.com

Michigan
Michigan.Quotes@allegion.com

Mid Atlantic North
(New York, Western Pennsylvania)
Mid.Atlantic.North.Quotes@allegion.com

Mid Atlantic South
(Delaware, Eastern Pennsylvania, Maryland, Northern Virginia, Southern New Jersey, Washington DC)
Mid.Atlantic.South.Quotes@allegion.com

Midwest
(Indiana, Kentucky, Ohio, West Virginia)
Midwest.Quotes@allegion.com

Mountain States
(Colorado, Idaho, Montana, Nevada, Utah, Wyoming)
Mtn.States.Quotes@allegion.com

New England
(Connecticut, Main, Massachusetts, New Hampshire, Rhode Island, Vermont)
NewEngland.Quotes@allegion.com

North Central
(Minnesota, North Dakota, South Dakota)
NorthCentral.Quotes@allegion.com

Northern California
NoCal.Quotes@allegion.com

Northwest
(Alaska, Oregon, Washington)
Northwest.Quotes@allegion.com

South
(Alabama, Georgia, Louisiana, Mississippi, Tennessee)
South.Quotes@allegion.com

Southern California
(California-Southern, Hawaii)
SoCal.Quotes@allegion.com

Southwest
(Arizona, New Mexico)
Southwest.Quotes@allegion.com

Texas
(Arkansas, Texas, Oklahoma)
Texas.Quotes@allegion.com

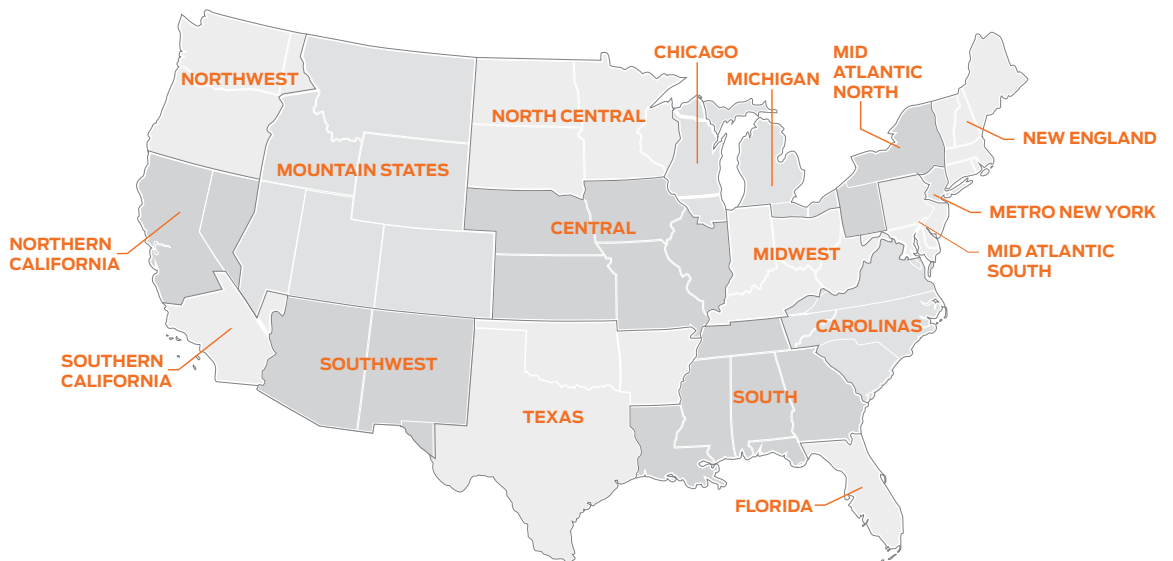

Contents

Doing business with Allegion	4	4310HSA Series	72
About the Allegion Catalog Nomenclature (ACNs)	5	4410HSA Series	73
How to order	6	SEM magnets	74
Finishes	8	Fire and life safety parts and accessories.....	75
Glossary	9	High security	81
1000 Series	10	2210 Series	81
1250 Series	10	4210 Series	82
1260 Series	11	4210T Series	83
1450 Series	12	4510 Series	84
1450T Series	13	4510T Series	85
1460 Series	14	High security parts and accessories.....	86
1460T Series	16	Pneumatic powered auto operator	89
1000 Series parts and accessories	17	2610 Series	89
4000 Series	25	4810 Series.....	90
4000T Series	25	4820 Series.....	91
4010 Series	26	4840 Series.....	92
4010T Series	27	7900 Series control boxes	93
4020 Series	28	7900 Series control box components	95
4020T Series	29	Pneumatic powered auto operator parts	96
4030 Series	30	Electrohydraulic auto operator	100
4030T Series	31	4630 Series.....	100
4040XP Series	32	4640 Series.....	101
4040XPT Series	34	6400 Series	102
4040XPT Series	35	6440XP Series.....	103
4050A Series.....	36	Electrohydraulic auto operator parts	104
4050AT Series	37	Electromechanical Senior Swing auto operator	106
4110 Series	38	2810 Series	106
4110T Series	39	2850 Series.....	107
4000 Series parts and accessories.....	40	2860 Series.....	108
Concealed	54	9530 Series.....	109
2010 Series.....	54	9540 Series.....	110
2030 Series.....	55	9550 Series.....	111
3030 Series.....	56	9560 Series.....	112
3130 Series	57	Electromechanical Benchmark auto operator	113
5010 Series.....	58	9130 Series	113
5030 Series.....	59	9140 Series.....	114
6030 Series.....	60	9150 Series.....	115
Concealed parts and accessories	61	Electromechanical auto operator parts and accessories.....	116
Fire and life safety	66	Actuators and accessories	128
3130SE Series.....	66	8310 Series Touchless Actuators	129
4040SE Series.....	67	8310 Series Touchless Actuators	131
4040SEH Series.....	68	8310 Series RESTROOM KITS.....	133
2310ME Series	69	8310 Series Actuators	135
4310ME Series.....	70	Miscellaneous parts	152
4410ME Series.....	71		

Policies and Documents

The purchase of Allegion products is governed by the Allegion Authorized Seller Program. For program terms and conditions, and other program details, please visit: www.allegion.com/AuthorizedSeller.

For Warranty information, visit us.allegion.com/warranty or contact Customer Service at 877-671-7011.



Online ordering is available through Estimate to Order (ETO)

ETO offers much more than placing online orders including:

- Net price and list price are both displayed based on your buying program.
- Configure products, build hardware sets and place an order, or you can export to Excel.
- Build a dynamic cross-reference between your part numbers and Allegion part numbers. Any time a description, price or other product data is changed, your cross-reference will automatically be updated.
- Request a quote or quote revision directly from an estimate

Visit <http://360portal.allegion.com> to get started or email online.ordering.access@allegion.com to sign up.

To learn more about how ETO works and its features, visit: us.allegion.com/ETODirect.

Traditional ordering methods: Email: allegion_orders@allegion.com
 Fax: 1-800-248-1460

When using traditional ordering methods, list the product attributes in the order outlined in this price book, which follow the ACN format guidelines.

ALLEGION PRODUCT CATEGORIES		
Subcategory	Allegion product categories	Products included
1000 Series	DCTL.LCN.1250	1250
	DCTL.LCN.1260	1260
	DCTL.LCN.1450	1450
	DCTL.LCN.1460	1460/1460T
4000 Series	DCTL.LCN.4000T	4000T
	DCTL.LCN.4010/4020/4110	4010/4010T, 4020/4020T, 4110/4110T
	DCTL.LCN.4050	4050A/4050AT
	DCTL.LCN.4000/4040	4040, 4040XP/4040XPT
Concealed	DCTL.LCN.520/4030	4030/4030T
	DCTL.LCN.2010/5010	2010, 5010
	DCTL.LCN.2030/5030/6030	2030, 5030, 6030
Fire/life safety closers/holders	DCTL.LCN.3030/330	3030
	DCTL.LCN.MAGNET	SEM
	DCTL.LCN.SE	3130SE, 4040SE, 4040SEH
High security	DCTL.LCN.ME	2310ME, 4310ME, 4410ME, 4310HSA, 4410HSA
	DCTL.LCN.2210/2210DPS	2210, 2210DPS
Auto operators	DCTL.LCN.4210/4510	4210/4210T, 4510/4510T
	AUTO.LCN.PNEU_EQ - 2600/4800/7900	2610, 4810, 4820, 4840, 7900
	AUTO.LCN.ELEC EQ - 4600	4630, 4640
	COM.AUTO.LCN.6400_COMPACT	6400
Actuator and accessories	AUTO.LCN.SSWING - 2800/9500	2810, 2850, 2860, 9530, 9540, 9550, 9560
	AUTO.LCN.BNCMARK - 9100	9130, 9140, 9150
Parts	DCTL.LCN.8310	8130
Door holder	DCTL.LCN.DCTLLCNPARTS	Parts
	PAH	PAH60

You can **configure and price a full range of products** using the tables and rules shown in this book.

The simplified structure of pricing and product data in this book creates an easier configuration experience and a quicker update process for future price increases. Pricing logic used in this format makes the product and price easier to understand and has enabled Allegion to provide customers with a **digital data set of pricing, available for download at <http://360portal.allegion.com>**.

As a result, the **How to Order formats have been updated to match the Allegion Catalog Nomenclature (ACN) logic**. ACNs are descriptive, unique identifiers that set standards on how to order products and require default, consistent naming conventions for all product attributes across Allegion brands.

For more information about ACNs, please visit us.allegion.com/acnsupport or email ACNHelp@allegion.com.













Published in this book are ACNs for the most **commonly ordered product configurations**. These were created for easy access when creating basic orders.

How to order a common product

Common products can be ordered using the standard Allegion Catalog Nomenclature (ACN). The ACN a unique, descriptive identifier for Allegion products. Each attribute in an ACN must be separated by a period but there is no need to detail out all of the default product attributes. Default product attributes are listed for each series. All closers conform to standards UL10C and UBC 7-2 (1997).

- Any field shown with brackets [] must be filled in
- Finishes should be listed using their BHMA finish as shown in this book
- When a dimension is required, fractions of an inch will be written with the “/” symbol separating the numerator and the denominator (example 1/2)
- For dimensions that contain a whole number and a fraction, a hyphen “-” will be added after the whole number and before the fraction (example 2-1/2)

ACN for these commonly ordered products	PRICE BASED ON FINISH			
	POWDER COAT		PLATED (INCLUDES METAL COVER)	
	622	689	616  632 	
	690	691	633  639 	
	693	695	652  646  651 	
	696			
DEFAULT CONFIGURATIONS				
Model	Arm	Finish	Handing	
4040XP	REGARM	[Finish]		
4040XP	RWPA	[Finish]		
4040XP	HLONG	[Finish]		
4040XP	EDA	[Finish]		
 4040XP	HEDA	[Finish]	[RH, LH]	
4040XP	CUSH	[Finish]		
4040XP	HCUSH	[Finish]		
ADDITIONAL COMMON CONFIGURATIONS				
Model	Arm	Finish	Cover	Handing
 4040XP	RW62A	[Finish]	MC	[RH, LH]
 4040XP	EDA	[Finish]	MC	[RH, LH]
 4040XP	RWPA	[Finish]	MC	[RH, LH]
Model	Arm	Finish	Screw pack	
4040XP	RWPA	[Finish]	TBSRT	
4040XP	EDA	[Finish]	TBSRT	

 Handed

If you do not see the product you need published with an ACN, you can **configure and price any product using the tables and rules shown** at the bottom of each page.

How to order less common products

LCN default and common products can be modified to include options such as SRI, alternate covers, custom header lengths, options, etc. Modifications are available using the rules and price adjustments at the bottom of each page. If an item or price is not listed, please consult the factory for availability and pricing.

- All applicable product attributes must be provided in the order shown below
- Each value must be separated by a period
- Finishes should be listed using their BHMA finish as shown in this book
- When a dimension is required, fractions of an inch will be written with the “/” symbol separating the numerator and the denominator (example 1/2)
- For dimensions that contain a whole number and a fraction, a hyphen “-” will be added after the whole number and before the fraction (example 2-1/2)

Series	Cylinder	Arm type	Track type	Finish	SRI option	Cover	Handing	Screw package	Door thickness	Special template	Concealed switch	Voltage	Header	Header length	Flush ceiling application	Closer stop	Header bracket	Buy America Act
1	2	3	4	5	6	7	8	9	10	11	12	13	14	15	16	17	18	19

- | | |
|---|--|
| <p>1 Series: Required for all orders.</p> <p>2 Cylinder: Only required when deviating from the product's default.</p> <p>3 Arm type: Required for any series where more than one arm option exists.</p> <p>4 Track type: Required for any track series where more than one track option exists.</p> <p>5 Finish: Required for all orders.</p> <p>6 SRI option: Specify only when this is a desired option.</p> <p>7 Cover: Only required when deviating from the product's default.</p> <p>8 Handing: Specify when any product component requires handing or when choosing a plated finish that requires a handed metal cover.</p> <p>9 Screw package: Only required when deviating from the product's default.</p> <p>10 Door thickness: Required only when through a bolt screw pack is chosen and door thickness is greater than 1-3/4".</p> | <p>11 Special template (ST): If a special template is know, enter it here. If a special application template is needed, contact LCN Product Support at closers_techprodsupport@allegion.com.</p> <p>12 Concealed switch: Optional.</p> <p>13 Voltage: Only required when deviating from the product's default.</p> <p>14 Header: Required for Senior Swing products only.</p> <p>15 Header length: Required for Senior Swing products only.</p> <p>16 Flush ceiling application: Optional</p> <p>17 Closer stop: Optional</p> <p>18 Header bracket: Only required when deviating from the product's default.</p> <p>19 Buy America Act: Must specify if required for 1250 or 1450 Series. 1250 and 1450 with BAA only available with RWPA or HWPAs in 689 or 695.</p> |
|---|--|

Powder coat finishes

LCN closers can be specified in six standard or over 150 custom powder coated finishes. Powder coating provides superior protection against the effects of weathering and provides a durable, chip resistant finish. For information about custom finishes, plated finishes and a special rust inhibiting (SRI) process, see the [LCN General Information Catalog](#).

Standard powder coated finishes

LCN powder finishes exceed ANSI/BHMA standard A156.4 for corrosion resistance by at least a factor of four. LCN powder coat finishes combined with the LCN Special Rust Inhibitor (SRI) pretreatment exceed this standard even further.

- 622 Matte Black (MTBLK)
- 689 Aluminum (AL)
- 690 Statuary Bronze (STAT)
- 691 Light Bronze (LTBRZ)
- 693 Gloss Black (GLBLK)
- 695 Dark Bronze (DKBRZ)
- 696 Brass (BRASS)

 See the [LCN General Information Catalog](#) for colors

Optional SRI

When powder coated closers are installed in high humidity or potentially corrosive installations like swimming pools, water treatment facilities or near large bodies of water, specify LCN SRI pretreatment. This optional process is applied prior to the LCN powder coat finish and greatly exceeds ANSI/BHMA Standard A156.4 for corrosion resistance.

Optional plated finishes

LCN offers 7 plated finishes at additional cost. LCN plated finishes exceed ANSI/BHMA standard A156.4 for corrosion resistance.

- 616 Satin Bronze, Blackened (US11)
- 632 Bright Brass (US3)
- 633 Satin Brass (US4)
- 639 Satin Bronze (US10)
- 646 Satin Nickel (US15)
- 651 Bright Chrome (US26)
- 652 Satin Chrome (US26D)

Optional custom powder coated (RAL) finishes

 [View custom powder coat \(RAL\) finishes](#)

- 150+ custom finishes (contact customer service for availability)
- LCN also offers a Brite Metallic (MTLPC) powder coat finish
- Superior appearance
- Environmentally friendly process
- Durable and chip resistant
- Corrosion resistant
- Match doors, frames, and hardware

Note: Custom powder coat finishes require a metal cover.

Arm and track abbreviations

Listed below are ACN values and descriptions for each arm and track type.

ARMS	
ACN value	ACN Description
ARMCP	2-3/4" Center Pivot Arm
ARMCP2	2-3/4" Center Pivot Arm (Pair)
ARMOP	3-3/4" Offset Pivot Arm
ARMOP2	3-3/4" Offset Pivot Arm (Pair)
CUSH	Cush-n-Stop Arm
DE	Double Egress Arm
DHWP	H Arm with 62PA for Delay
DRWP	Regular Arm with 62PA for Delay
EDA	Extra Duty Arm
EDAW62G	Extra Duty Arm with 62G Thick Hub Shoe
FL	Fusible Link Arm
H	Hold Open Arm
HCUSH	Hold Open Cush-n-Stop Arm
HD	Heavy Duty Arm
HD62A	Heavy Duty with 62A Auxiliary Shoe
HDLONG	Heavy Duty Long Arm
HDP	Heavy Duty with Parallel Arm Bracket
HEDA	Hold Open Extra Duty Arm
HEDA62G	Hold Open Extra Duty Arm with 62G Thick Hub Shoe
HLONG	Hold Open Long Arm
HWPA	Hold Open with Parallel Arm Bracket
LD	Light Duty Arm
LD62A	Light Duty Arm with Auxiliary Shoe
LDPA	Light Duty Arm with Parallel Arm Shoe
LONG	Long Arm
LONG2	Long Arm (Pair)
REGARM	Regular Arm
REGARM2	Regular Arm Pair
REGSTDDE	1 Regular Arm and 1 Standard Arm (Double Egress)
RW62A	Regular Arm with 62A Auxiliary Shoe
RWPA	Regular Arm with Parallel Arm Bracket
SCUSH	Spring Cush-n-Stop Arm
SF	Swing Free Arm
SHCUSH	Spring Hold Open Cush-n-Stop Arm
STDTRKARM	Standard Arm
STDTRKARM2	Standard Arm Assembly with track roller (Handed)
STDTRKSECARM	Standard Security Arm
XLONG	Extra Long Arm

TRACKS	
ACN value	ACN Description
BUMP	Track with Bumper
H	Hold Open Track
HBMP	Hold Open Track with Bumper
LONG	Long Track
STDSECTRK	Standard Security Track
STDTRK	Standard Track

1250 SERIES

The 1250 Series cast aluminum closer is designed for low-frequency and low-abusive traffic areas. Combining dependable operation, low maintenance and a stylish look this closer is ideal for aluminum storefronts and interior offices.

622	689	690	691
MTBLK	AL	STAT	LTBRZ
693	695	696	
GLBLK	DKBRZ	BRASS	

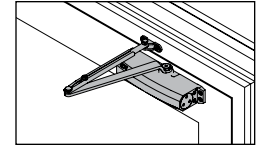

ACN for these commonly ordered products

PRICE BASED ON FINISH

POWDER COAT

622	689	690	691
693	695	696	

DEFAULT AND COMMON CONFIGURATIONS

Pricing includes default options shown below unless otherwise specified. Specification rules, additional options and pricing adders are shown in the tables below.

Cylinder

Cast Aluminum Cylinder Assembly (CYL)

Cover

Less Cover (LESSCOV)

Screw package

Universal Screws (UNIV)

DEFAULT CONFIGURATIONS				
Model	Arm	Finish	Handing	
1250	RWPA	[Finish]		\$262.00
1250	RW62A	[Finish]		\$279.00
1250	LONG	[Finish]		\$256.00
1250	HWP	[Finish]		\$298.00
1250	HLONG	[Finish]		\$304.00
1250	EDA	[Finish]		\$322.00
1250	HEDA	[Finish]	[RH, LH]	\$365.00
1250	CUSH	[Finish]		\$365.00
1250	HCUSH	[Finish]		\$437.00
1250	SCUSH	[Finish]		\$437.00
1250	SHCUSH	[Finish]		\$511.00
ADDITIONAL COMMON CONFIGURATIONS				
Model	Arm	Finish	Cover	
1250	RWPA	[Finish]	SLIMPC	\$280.00

SPECIFICATION RULES, ADDITIONAL OPTIONS AND PRICING ADDERS

Order of attributes when placing an order for a non-standard configuration. See parts section for individual parts pricing. Attributes show in CAPS are required. Other attributes are required only if you are deviating from the product's default.

MODEL . ARM TYPE . FINISH . Special rust inhibitor . Cover . Handing . Screw package . Door thickness . Buy America Act

Special rust inhibiting primer	Specify	Price adder
Special Rust Inhibitor for Powder Coat Finishes	SRI	\$50.00
Cover	Specify	Price adder
Less Cover (LESSCOV) - Default	-	-
Slim Line Plastic Cover	SLIMPC	\$18.00
Screw package	Specify	Price adder
Universal Screws (UNIV) - Default	-	-
Torx Machine Screws	TORX	\$16.00
Through Bolt and Torx Machine Screws	TBTRX	\$16.00

Door thickness	Specify
Specify if door thickness is different than 1-3/4" when choosing a through bolt screw pack	[]
Buy America Act	Specify Price adder
Buy America Act - Only specify when BAA is required for 1250 with RWPA or HWP arms in 689 or 695	BAA \$37.00

Handing required

1260 SERIES

The 1260 is a light to medium duty cast iron closer designed to fit the most common commercial foot print. It's adjustable for spring sizes 1-5, features a complete line of regular and extra duty arms, and an optional Quick Fix™ bracket kit.

622	689	690	691
MTBLK	AL	STAT	LTBRZ
693	695	696	
GLBLK	DKBRZ	BRASS	

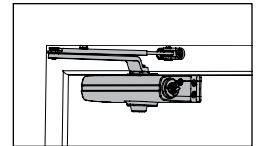

ACN for these commonly ordered products				PRICE BASED ON FINISH			
				POWDER COAT			
				622	689	690	691
				693	695	696	
DEFAULT CONFIGURATIONS							
Model	Arm	Finish	Handing				
1261	REGARM	[Finish]		\$358.00			
1261	RWPA	[Finish]		\$365.00			
1261	RW62A	[Finish]		\$383.00			
1261	LONG	[Finish]		\$358.00			
1261	H	[Finish]		\$397.00			
1261	HWPA	[Finish]		\$402.00			
1261	HLONG	[Finish]		\$407.00			
1261	EDA	[Finish]		\$427.00			
1261	EDAW62G	[Finish]		\$439.00			
🔓	1261	HEDA	[Finish] . [RH, LH]	\$469.00			
🔓	1261	HEDA62G	[Finish] . [RH, LH]	\$482.00			
1261	CUSH	[Finish]		\$469.00			
1261	HCUSH	[Finish]		\$544.00			
1261	SHCUSH	[Finish]		\$618.00			
1261	SCUSH	[Finish]		\$544.00			
ADDITIONAL COMMON CONFIGURATIONS							
Model	Arm	Finish	Cover				
1261	RWPA	[Finish]	SLIMPC	\$383.00			
1261	RW62A	[Finish]	SLIMPC	\$401.00			
Model	Arm	Finish	Screw pack				
1261	RWPA	[Finish]	TBSRT	\$365.00			

DEFAULT AND COMMON CONFIGURATIONS

Pricing includes default options shown below unless otherwise specified. Specification rules, additional options and pricing adders are shown in the tables below.

Cylinder
Cast Iron Cylinder Assembly (CYL)

Cover
Less Cover (LESSCOV)

Screw package
Self Reaming and Tapping Screws (SRT)

BAA Compliant
See the [Allegion Buy America/ Buy American and Trade Agreement Acts \(BAA and TAA\) Compliance Guide](#) for full details

SPECIFICATION RULES, ADDITIONAL OPTIONS AND PRICING ADDERS

Order of attributes when placing an order for a non-standard configuration. See parts section for individual parts pricing. Attributes show in CAPS are required. Other attributes are required only if you are deviating from the product's default.

MODEL . ARM TYPE . FINISH . Special rust inhibitor . Cover . Handing . Screw package . Door thickness

Special rust inhibiting primer	Specify	Price adder
Special Rust Inhibitor for Powder Coat Finishes	SRI	\$50.00
Cover	Specify	Price adder
Less Cover (LESSCOV) - Default	-	-
Slim Line Plastic Cover	SLIMPC	\$18.00
Screw package	Specify	Price adder
Self Reaming and Tapping Screws (SRT) - Default	-	-
Through Bolt Self Reaming and Tapping Screws	TBSRT	\$0.00
Wood and Machine Screws	WMS	\$0.00

Screw package	Specify	Price adder
Through Bolt Wood and Machine Screws	TBWMS	\$0.00
Torx Machine Screws	TORX	\$16.00
Through Bolt and Torx Machine Screws	TBTRX	\$16.00
Door thickness	Specify	
Specify if door thickness is different than 1-3/4" when choosing a through bolt screw pack	[]	

🔓 Handing required

1450 SERIES

The 1450 Series cast aluminum closer was specially designed to deliver consistent, dependable, long-term performance in frequently-used, low-abusive traffic areas. With industry's most common hole pattern it can fit a range of applications like aftermarket replacement, aluminum storefronts and new construction projects.

622	689	690	691
MTBLK	AL	STAT	LTBRZ
693	695	696	
GLBLK	DKBRZ	BRASS	

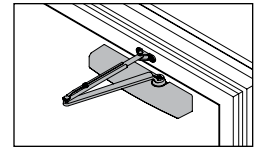

ACN for these commonly ordered products				PRICE BASED ON FINISH			
				POWDER COAT			
				622	689	690	691
				693	695	696	
DEFAULT CONFIGURATIONS							
Model	Arm	Finish	Handing				
1450	RWPA	[Finish]		\$347.00			
1450	RW62A	[Finish]		\$364.00			
1450	LONG	[Finish]		\$341.00			
1450	HWPA	[Finish]		\$383.00			
1450	HLONG	[Finish]		\$389.00			
1450	EDA	[Finish]		\$407.00			
1450	EDAW62G	[Finish]		\$420.00			
1450	HEDA	[Finish]	[RH, LH]	\$450.00			
1450	CUSH	[Finish]		\$450.00			
1450	HCUSH	[Finish]		\$522.00			
1450	SCUSH	[Finish]		\$522.00			
1450	SHCUSH	[Finish]		\$596.00			
ADDITIONAL COMMON CONFIGURATIONS							
Model	Arm	Finish	Cover				
1450	RWPA	[Finish]	FCP	\$360.00			
1450	RW62A	[Finish]	FCP	\$377.00			

DEFAULT AND COMMON CONFIGURATIONS

Pricing includes default options shown below unless otherwise specified. Specification rules, additional options and pricing adders are shown in the tables below.

Cylinder
Cast Aluminum Cylinder Assembly (CYL)

Cover
Slim Line Plastic Cover (SLIMPC)

Screw package
Universal Screws (UNIV)

SPECIFICATION RULES, ADDITIONAL OPTIONS AND PRICING ADDERS

Order of attributes when placing an order for a non-standard configuration. See parts section for individual parts pricing. Attributes show in CAPS are required. Other attributes are required only if you are deviating from the product's default.

MODEL . ARM TYPE . FINISH . Special rust inhibitor . Cover . Handing . Screw package . Door thickness . Buy America Act

Cylinder	Specify	Price adder
Cast Aluminum Cylinder Assembly (CYL) - Default	-	-
Delay Action Cylinder	CYLDEL	\$54.00
Custom powder coat finishes	Specify	Price adder
Custom Power Coat Finish - Requires metal cover	RAL []	\$50.00
Brite Metallic Powder Coat - Requires metal cover	MTLPC	\$73.00
Special rust inhibiting primer	Specify	Price adder
Special Rust Inhibitor for Powder Coat Finishes	SRI	\$50.00
Cover	Specify	Price adder
Slim Line Plastic Cover (SLIMPC) - Default	-	-
Full Plastic Cover	FPC	\$13.00
☞ Metal Cover	MC	\$31.00

Screw package	Specify	Price adder
Universal Screws (UNIV) - Default	-	-
Torx Machine Screws	TORX	\$16.00
Through Bolt and Torx Machine Screws	TBTRX	\$16.00
Door thickness	Specify	
Specify if door thickness is different than 1-3/4" when choosing a through bolt screw pack	[]	
Buy America Act	Specify	Price adder
Buy America Act - Only specify when BAA is required for 1450 with RWPA or HWPA arms in 689 or 695	BAA	\$37.00

☞ Handing required

1450T SERIES

The 1450T is a fully universal slim line, single lever (track) arm closer designed for interior use on narrow head frames and top rails. Our patented appearance maintains the integrity of the building design making it a great choice for interior doors.

622	689	690	691
MTBLK	AL	STAT	LTBRZ
693	695	696	
GLBLK	DKBRZ	BRASS	

ACN for these commonly ordered products				PRICE BASED ON FINISH			
				POWDER COAT			
				622	689	690	691
				693	695	696	
DEFAULT CONFIGURATIONS							
Model	Track	Finish					
1450T	STDTRK	[Finish]		\$439.00			
1450T	H	[Finish]		\$468.00			
1450T	BUMP	[Finish]		\$444.00			
1450T	HBUMP	[Finish]		\$480.00			
ADDITIONAL COMMON CONFIGURATIONS							
Model	Arm	Finish	Cover				
1450T	STDTRK	[Finish]	FPC	\$452.00			

DEFAULT AND COMMON CONFIGURATIONS

Pricing includes default options shown below unless otherwise specified. Specification rules, additional options and pricing adders are shown in the tables below.

Cylinder

Cast Aluminum Cylinder Assembly (CYL)

Arm type

Standard Arm (STDTRKARM)

Cover

Slim Line Plastic Cover (SLIMPC)

Screw package

STDTRK and BUMP tracks:
Universal Screws (UNIV);

H and HBMP tracks: Hold Open
Universal Screws (HUNIV)

SPECIFICATION RULES, ADDITIONAL OPTIONS AND PRICING ADDERS

Order of attributes when placing an order for a non-standard configuration. See parts section for individual parts pricing. Attributes show in CAPS are required. Other attributes are required only if you are deviating from the product's default.

MODEL . TRACK TYPE . FINISH . Special rust inhibitor . Cover . Handing . Screw package . Door thickness . Buy America Act

Custom powder coat finishes	Specify	Price adder
Custom Power Coat Finish - Requires metal cover	RAL []	\$50.00
Brite Metallic Powder Coat - Requires metal cover	MTLPC	\$73.00
Special rust inhibiting primer	Specify	Price adder
Special Rust Inhibitor for Powder Coat Finishes	SRI	\$50.00
Cover	Specify	Price adder
Slim Line Plastic Cover (SLIMPC) - Default	-	-
Full Plastic Cover	FPC	\$13.00
 Metal Cover	MC	\$31.00

Screw package	Specify	Price adder
Universal Screws (UNIV) - Default	-	-
Hold Open Universal Screws (HUNIV) - Default	-	-
Torx Machine Screws	TORX	\$16.00
Through Bolt and Torx Machine Screws	TBTRX	\$16.00
Door thickness	Specify	
Specify if door thickness is different than 1-3/4" when choosing a through bolt screw pack	[]	

 Handing required

1460 SERIES

Designed for maximum versatility, the 1460, available with multiple cover options, can be used for both commercial and institutional applications. This fully universal closer offers a wide variety of options and fast and accurate installation.

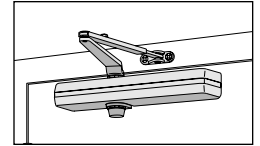

622	689	690	691	693	695	696	652	616	632	633	639	646	651
MTBLK	AL	STAT	LTBRZ	GLBLK	DKBRZ	BRASS	US26D	US11	US3	US4	US10	US15	US26

ACN for these commonly ordered products	PRICE BASED ON FINISH					
	POWDER COAT		652	PLATED (INCLUDES METAL COVER)		
	622	689		616	632	639
	690	691	633	639	646	651
	693	695	646	651		
	696					

DEFAULT AND COMMON CONFIGURATIONS

Pricing includes default options shown below unless otherwise specified. Specification rules, additional options and pricing adders are shown in the tables below.

Cylinder

Cast Iron Cylinder Assembly (CYL)

Cover

Slim Line Plastic Cover (SLIMPC)

Plated prices include a Designer Series Metal Cover (DS) and requires handing.

Screw package

Self reaming and tapping screws (SRT)

BAA Compliant

See the [Allegion Buy America/ Buy American and Trade Agreement Acts \(BAA and TAA\) Compliance Guide](#) for full details

DEFAULT CONFIGURATIONS							
Model	Arm	Finish	Handing				
1461	REGARM	[Finish]		\$451.00	\$910.00	\$995.00	
1461	RWPA	[Finish]		\$458.00	\$915.00	\$1,003.00	
1461	RW62A	[Finish]		\$476.00	\$934.00	\$1,021.00	
1461	LONG	[Finish]		\$451.00	\$910.00	\$995.00	
1461	H	[Finish]		\$490.00	\$946.00	\$1,032.00	
1461	HWPA	[Finish]		\$495.00	\$954.00	\$1,040.00	
1461	HLONG	[Finish]		\$500.00	\$960.00	\$1,045.00	
1461	HD	[Finish]		\$495.00	\$954.00	\$1,040.00	
1461	HDPA	[Finish]		\$500.00	\$960.00	\$1,045.00	
1461	HD62A	[Finish]		\$520.00	\$977.00	\$1,064.00	
1461	HDLONG	[Finish]		\$500.00	\$960.00	\$1,045.00	
1461	EDA	[Finish]		\$520.00	\$977.00	\$1,064.00	
1461	EDAW62G	[Finish]		\$532.00	\$991.00	\$1,076.00	
1461	HEDA	[Finish]	[RH, LH]	\$562.00	\$1,021.00	\$1,107.00	
1461	HEDA62G	[Finish]	[RH, LH]	\$575.00	\$1,033.00	\$1,120.00	
1461	CUSH	[Finish]		\$562.00	\$1,021.00	\$1,107.00	
1461	HCUSH	[Finish]		\$637.00	\$1,095.00	\$1,180.00	
1461	SCUSH	[Finish]		\$637.00	\$1,095.00	\$1,180.00	
1461	SHCUSH	[Finish]		\$711.00	\$1,170.00	\$1,256.00	
ADDITIONAL COMMON CONFIGURATIONS							
Model	Arm	Finish	Cover				
1461	RWPA	[Finish]	FPC	\$471.00	N/A	N/A	
1461	RW62A	[Finish]	FPC	\$489.00	N/A	NA	
Model	Arm	Finish	Cover	Screw pack			
1461	RWPA	[Finish]	FPC	TBSRT	\$471.00	N/A	N/A
Model	Arm	Finish	Screw pack				
1461	RWPA	[Finish]	TBSRT	\$458.00	\$915.00	\$1,003.00	

Handing required

Indicates products that have EPD documentation available and meet LEED v4.

1460 SERIES

SPECIFICATION RULES, ADDITIONAL OPTIONS AND PRICING ADDERS

Order of attributes when placing an order for a non-standard configuration. See parts section for individual parts pricing. Attributes show in CAPS are required. Other attributes are required only if you are deviating from the product's default.

MODEL . ARM TYPE . FINISH . Special rust inhibitor . Cover . Handing . Screw package . Door thickness

Cylinder	Specify	Price adder
Cast Iron Cylinder Assembly (CYL) - Default	-	-
Delay Action Cylinder	CYLDEL	\$55.00
Custom powder coat finishes	Specify	Price adder
Apply price adder to powder coat price		
Custom Power Coat Finish - Requires metal cover	RAL []	\$50.00
Brite Metallic Powder Coat - Requires metal cover	MTLPC	\$73.00
Special rust inhibiting primer	Specify	Price adder
Special Rust Inhibitor for Powder Coat Finishes	SRI	\$50.00
Cover	Specify	Price adder
Slim Line Plastic Cover (SLIMPC) - Default	-	-
Full Plastic Cover	FPC	\$13.00
Designer Series Metal Cover - included in plated finish price	DS	\$37.00
Screw package	Specify	Price adder
Self reaming and tapping screws (SRT) - Default	-	-
Through Bolt Self Reaming and Tapping Screws	TBSRT	\$0.00
Wood and Machine Screws	WMS	\$0.00
Through Bolt Wood and Machine Screws	TBWMS	\$0.00
Torx Machine Screws	TORX	\$16.00
Through Bolt and Torx Machine Screws	TBTRX	\$16.00
Door thickness	Specify	
Specify if door thickness is different than 1-3/4" when choosing a through bolt screw pack	[]	







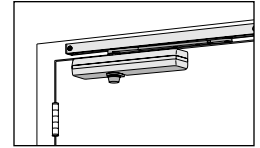

☞ Handing required

1460T SERIES 

The 1460T is a fully universal slim line, single lever (track) arm closer designed for interior use on narrow head frames and top rails. The modern styling and small projection make it an excellent choice for interior doors.



622	689	690	691	693	695	696	652	616	632	633	639	646	651
MTBLK	AL	STAT	LTBRZ	GLBLK	DKBRZ	BRASS	US26D	US11	US3	US4	US10	US15	US26

ACN for these commonly ordered products	PRICE BASED ON FINISH					
	POWDER COAT			PLATED (INCLUDES METAL COVER)		
	622	689	690	616 	632 	633 
691	693	695	652 	633 	639 	
696			646 	651 		

DEFAULT CONFIGURATIONS						
Model	Track	Finish				
[1460 or 1461]T	STDTRK	[Finish]	\$551.00	\$909.00	\$1,008.00	
[1460 or 1461]T	H	[Finish]	\$581.00	\$939.00	\$1,038.00	
[1460 or 1461]T	BUMP	[Finish]	\$556.00	\$914.00	\$1,013.00	
[1460 or 1461]T	HBUMP	[Finish]	\$593.00	\$951.00	\$1,050.00	

SPECIFICATION RULES, ADDITIONAL OPTIONS AND PRICING ADDERS

Order of attributes when placing an order for a non-standard configuration. See parts section for individual parts pricing. Attributes show in CAPS are required. Other attributes are required only if you are deviating from the product's default.

MODEL . TRACK TYPE . FINISH . Special rust inhibitor . Cover . Handing . Screw package . Door thickness

Custom powder coat finishes	Specify	Price adder
Apply price adder to powder coat price		
Custom Power Coat Finish - Requires metal cover	RAL []	\$50.00
Brite Metallic Powder Coat - Requires metal cover	MTLPC	\$73.00
Special rust inhibiting primer	Specify	Price adder
Special Rust Inhibitor for Powder Coat Finishes	SRI	\$50.00
Cover	Specify	Price adder
Slim Line Plastic Cover (SLIMPC) - Default	-	-
Full Plastic Cover	FPC	\$13.00
 Designer Series Metal Cover - included in plated finish price	DS	\$37.00
Screw package	Specify	Price adder
Self Reaming and Tapping Screws (SRT) - Default	-	-
Through Bolt Self Reaming and Tapping Screws	TBSRT	\$0.00
Hold Open Self Reaming and Tapping Screws (HSRT) - Default	-	-
Hold Open Through Bolt Self Reaming and Tapping Screws	HTBSRT	\$0.00
Wood and Machine Screws	WMS	\$0.00
Through Bolt Wood and Machine Screws	TBWMS	\$0.00
Hold Open Wood and Machine Screws	HWMS	\$0.00
Hold Open Through Bolt Wood and Machine Screws	HTBWMS	\$0.00
Torx Machine Screws	TORX	\$16.00
Through Bolt and Torx Machine Screws	TBTRX	\$16.00
Hold Open Torx Screws	HTORX	\$16.00
Hold Open Through Bolt Torx Screws	HTBTX	\$16.00
Door thickness	Specify	
Specify if door thickness is different than 1-3/4" when choosing a through bolt screw pack	[]	

DEFAULT AND COMMON CONFIGURATIONS

Pricing includes default options shown below unless otherwise specified. Specification rules, additional options and pricing adders are shown in the tables below.

Cylinder

Cast Aluminum Cylinder Assembly (CYL)

Arm type

Standard Arm (STDTRKARM)

Cover

Slim Line Plastic Cover (SLIMPC)

Plated prices include a Designer Series Metal Cover (DS) and requires handing.

Screw package

Screw package

STDTRK and BUMP tracks: Self Reaming Tap Screws (SRT);

H and HBMP tracks: Hold Open Self Reaming and Tapping Screws (HSRT)

BAA Compliant

See the [Allegion Buy America/ Buy American and Trade Agreement Acts \(BAA and TAA\) Compliance Guide](#) for full details

 Handed

 Indicates products that have EPD documentation available and meet LEED v4.

PARTS AND ACCESSORIES

Powder coat

622	Matte Black (MTBLK)
689	Aluminum (AL)
690	Statuary Bronze (STAT)
691	Light Bronze (LTBRZ)
693	Black (GLBLK)
695	Dark Bronze (DKBRZ)
696	Brass (BRASS)

Plated

616	Satin Bronze, Blackened (US11)
632	Brass (US3)
633	Satin Brass (US4)
639	Satin Bronze (US10)
646	Satin Nickel (US15)
651	Bright Chrome (US26)
652	Satin Chrome (US26D)

Anodized

628	Aluminum (ANCLR)
710	Dark Bronze (ANDKB)

Handing

RH	Right hand
LH	Left hand

1250 Series	Specify			Price
	Part number	Finish	Handing	Powder coat
Std Cylinder Assembly	1250-3071	.[Finish]	-	\$152.00
Reg Arm w/62PA	1250-3077/PA	.[Finish]	-	\$110.00
Reg Arm w/62A	1250-3077/62A	.[Finish]	-	\$127.00
Long Arm	1250-3077L	.[Finish]	-	\$104.00
Hold Open Arm w/62PA	1250-3049/PA	.[Finish]	-	\$146.00
Hold Open Long Arm	1250-3049L	.[Finish]	-	\$152.00
EDA Arm	1250-3077EDA	.[Finish]	-	\$170.00
 HEDA Arm	1250-3049EDA	.[Finish]	.[Handing]	\$213.00
CUSH Arm	1250-3077CUSH	.[Finish]	-	\$213.00
HCUSH Arm	1250-3049CUSH	.[Finish]	-	\$285.00
S Cush Arm	1250-3077SCUSH	.[Finish]	-	\$285.00
Spring H Cush Arm	1250-3049SCUSH	.[Finish]	-	\$359.00
Screw Pack	1250-UNIV	.[Finish]	-	\$31.00
Screw Pack	1250-TORX	.[Finish]	-	\$48.00
Screw Pack	1250-TBTRX	.[Finish]	-	\$48.00
Slim Cover	1250-72	.[Finish]	-	\$18.00
Plate	1250-18	.[Finish]	-	\$72.00
Plate	1250-18PA	.[Finish]	-	\$72.00
Cush Shoe Support	1250-30	.[Finish]	-	\$26.00
Spacer	1250-61	.[Finish]	-	\$26.00
Auxiliary Shoe	1250-62A	.[Finish]	-	\$49.00
PA Shoe	1250-62PA	.[Finish]	-	\$19.00
Shaft Cover	1250-146	.[Finish]	-	\$9.00
Spacer	1250-201	-	-	\$9.00
Panel Adapter	1250-419	.[Finish]	-	\$72.00
Spring CUSH Block	1250-3080	.[Finish]	-	\$72.00
Flat Box w/Label	1250-Flat Box	-	-	\$9.00
Instruction Sheet	1250-Instruction Sheet	-	-	\$7.00
Box and Instruction Sheet	1250-Rebox Kit	-	-	\$9.00

1260 Series	Specify			Price
	Part number	Finish	Handing	Powder coat
Std Cylinder Assembly	1261-3071	.[Finish]	-	\$253.00
Reg Arm	1260-3077	.[Finish]	-	\$105.00
Reg Arm w/62PA	1260-3077/PA	.[Finish]	-	\$112.00
Reg Arm w/62A	1260-3077/62A	.[Finish]	-	\$130.00

 Handed

PARTS AND ACCESSORIES

Powder coat

622	Matte Black (MTBLK)
689	Aluminum (AL)
690	Statuary Bronze (STAT)
691	Light Bronze (LTBRZ)
693	Black (GLBLK)
695	Dark Bronze (DKBRZ)
696	Brass (BRASS)

Plated

616	Satin Bronze, Blackened (US11)
632	Brass (US3)
633	Satin Brass (US4)
639	Satin Bronze (US10)
646	Satin Nickel (US15)
651	Bright Chrome (US26)
652	Satin Chrome (US26D)

Anodized

628	Aluminum (ANCLR)
710	Dark Bronze (ANDKB)

Handing

RH	Right hand
LH	Left hand

1260 Series	Specify			Price
	Part number	Finish	Handing	Powder coat
Long Arm	1260-3077L	.[Finish]	-	\$105.00
Hold Open Arm	1260-3049	.[Finish]	-	\$144.00
Hold Open Arm w/62PA	1260-3049/PA	.[Finish]	-	\$149.00
Hold Open Long Arm	1260-3049L	.[Finish]	-	\$154.00
EDA Arm	1260-3077EDA	.[Finish]	-	\$174.00
EDA Arm w/62G	1260-3077EDA/G	.[Finish]	-	\$186.00
 HEDA Arm	1260-3049EDA	.[Finish]	.[Handing]	\$216.00
 HEDA Arm w/62G	1260-3049EDA/G	.[Finish]	.[Handing]	\$229.00
CUSH Arm	1260-3077CUSH	.[Finish]	-	\$216.00
HCUSH Arm	1260-3049CUSH	.[Finish]	-	\$291.00
Slim Cover	1260-72	.[Finish]	-	\$18.00
Screw Pack	1260-SRT	.[Finish]	-	\$31.00
Screw Pack	1260-TBSRT	.[Finish]	-	\$31.00
Screw Pack	1260-WMS	.[Finish]	-	\$31.00
Screw Pack	1260-TBWMS	.[Finish]	-	\$31.00
Screw Pack	1260-TORX	.[Finish]	-	\$49.00
Screw Pack	1260-TBTRX	.[Finish]	-	\$49.00
Plate	1260-18	.[Finish]	-	\$73.00
Plate	1260-18PA	.[Finish]	-	\$73.00
Plate	1260-18QF	.[Finish]	-	\$73.00
Cush Shoe Support	1260-30	.[Finish]	-	\$26.00
Hold Open Stud	1260-37	.[Finish]	-	\$31.00
Hold Open Nut	1260-41	.[Finish]	-	\$9.00
Hold Open Shoe	1260-45	.[Finish]	-	\$26.00
Hold Open Main Arm	1260-49	.[Finish]	-	\$81.00
Spacer	1260-61	.[Finish]	-	\$31.00
Auxiliary Shoe	1260-62A	.[Finish]	-	\$50.00
PA Shoe	1260-62PA	.[Finish]	-	\$19.00
Arm and Forearm	1260-77	.[Finish]	-	\$105.00
H Head and Tube	1260-78H	.[Finish]	-	\$86.00
Head and Long Tube	1260-78HL	.[Finish]	-	\$93.00
Rod and Shoe	1260-79	.[Finish]	-	\$37.00
Long Rod and Shoe	1260-79LR	.[Finish]	-	\$37.00
Arm Screw	1260-83	.[Finish]	-	\$7.00
H Arm Screw	1260-83H	.[Finish]	-	\$7.00
Shaft Cover	1260-146	.[Finish]	-	\$9.00

 Handed

1260 Series	Specify			Price
	Part number	Finish	Handing	Powder coat
Arm Screw	1260-159	.[Finish]	-	\$7.00
Spacer	1260-201	-	-	\$9.00
Stop	1260-384	.[Finish]	-	\$26.00
Panel Adapter	1260-419	.[Finish]	-	\$81.00
Head and Tube Assembly	1260-3048	.[Finish]	-	\$105.00
Head and Long Tube Assembly	1260-3048L	.[Finish]	-	\$105.00
Flat Box w/Label	1260-Flat Box	-	-	\$9.00
Instruction Sheet	1260-Instruction Sheet	-	-	\$7.00
Box and Instruction Sheet	1260-Rebox Kit	-	-	\$9.00

1450 Series	Specify			Price
	Part number	Finish	Handing	Powder coat
Std Cylinder Assembly	1450-3071	.[Finish]	-	\$219.00
Delayed Action Cylinder Assembly	1450-3071DEL	.[Finish]	-	\$273.00
Reg Arm w/62PA	1450-3077/PA	.[Finish]	-	\$110.00
Reg Arm w/62A	1450-3077/62A	.[Finish]	-	\$127.00
Long Arm	1450-3077L	.[Finish]	-	\$104.00
H Arm w/62PA	1450-3049/PA	.[Finish]	-	\$146.00
H Long Arm	1450-3049L	.[Finish]	-	\$152.00
EDA Arm	1450-3077EDA	.[Finish]	-	\$170.00
EDA Arm w/62G	1450-3077EDA/G	.[Finish]	-	\$183.00
 H EDA Arm	1450-3049EDA	.[Finish]	.[Handing]	\$213.00
Cush Arm	1450-3077CNS	.[Finish]	-	\$213.00
H Cush Arm	1450-3049CNS	.[Finish]	-	\$285.00
S Cush Arm	1450-3077SCNS	.[Finish]	-	\$285.00
Spring H Cush Arm	1450-3049SCNS	.[Finish]	-	\$359.00
Standard Cover	1450-72	.[Finish]	-	\$18.00
Full Plastic Cover	1450-72FC	.[Finish]	-	\$31.00
 Full Metal Cover	1450-72MC	.[Finish]	.[Handing]	\$49.00
Alternate Cover	1450-72ALT	.[Finish]	-	\$31.00
Screw Pack	1450-UNIV	.[Finish]	-	\$31.00
Screw Pack	1450-TORX	.[Finish]	-	\$48.00
Screw Pack	1450-TBTRX	.[Finish]	-	\$48.00
Plate	1450-18	.[Finish]	-	\$72.00
Plate	1450-18FC	.[Finish]	-	\$72.00
Plate	1450-18PA	.[Finish]	-	\$72.00
Plate	1450-18PAFC	.[Finish]	-	\$72.00
Cush Shoe Support	1450-30	.[Finish]	-	\$26.00
Cover Screw	1450-31	.[Finish]	-	\$7.00
Spacer	1450-61	.[Finish]	-	\$26.00
Auxiliary Shoe	1450-62A	.[Finish]	-	\$49.00
PA Shoe	1450-62PA	.[Finish]	-	\$19.00
Shaft Cover	1450-146	.[Finish]	-	\$9.00

 Handed

PARTS AND ACCESSORIES

Powder coat

622	Matte Black (MTBLK)
689	Aluminum (AL)
690	Statuary Bronze (STAT)
691	Light Bronze (LTBRZ)
693	Black (GLBLK)
695	Dark Bronze (DKBRZ)
696	Brass (BRASS)

Plated

616	Satin Bronze, Blackened (US11)
632	Brass (US3)
633	Satin Brass (US4)
639	Satin Bronze (US10)
646	Satin Nickel (US15)
651	Bright Chrome (US26)
652	Satin Chrome (US26D)

Anodized

628	Aluminum (ANCLR)
710	Dark Bronze (ANDKB)

Handing

RH	Right hand
LH	Left hand

1450 Series	Specify			Price
	Part number	Finish	Handing	Powder coat
Panel Adapter	1450-419	.[Finish]	-	\$72.00
Spring Cush Block	1450-3080	.[Finish]	-	\$72.00
Flat Box w/Label	1450-Flat Box	-	-	\$9.00
Instruction Sheet	1450-Instruction Sheet	-	-	\$7.00
Box and Instruction Sheet	1450-Rebox Kit	-	-	\$9.00

1450T Series	Specify			Price
	Part number	Finish	Handing	Powder coat
Std Cylinder Assembly	1450T-3071	.[Finish]	-	\$219.00
Hold Open Track Roller	1450T-3034H	-	-	\$31.00
Standard Track	1450T-3038	.[Finish]	-	\$92.00
Track with Bumper	1450T-3038B	.[Finish]	-	\$97.00
Track with Hold Open and Bumper	1450T-3038HB	.[Finish]	-	\$133.00
Track with Hold Open	1450T-3038H	.[Finish]	-	\$121.00
Hold Open Clip	1450T-3054	-	-	\$31.00
Standard Arm	1450T-3077T	.[Finish]	-	\$110.00
Standard Cover	1450T-72	.[Finish]	-	\$18.00
Full Plastic Cover	1450T-72FC	.[Finish]	-	\$31.00
👤 Full Metal Cover	1450T-72MC	.[Finish]	.[Handing]	\$49.00
Screw Pack	1450T-UNIV	.[Finish]	-	\$62.00
Screw Pack	1450T-HUNIV	.[Finish]	-	\$62.00
Screw Pack	1450T-TORX	.[Finish]	-	\$77.00
Screw Pack	1450T-HTORX	.[Finish]	-	\$77.00
Screw Pack	1450T-TBTRX	.[Finish]	-	\$77.00
Plate	1450T-18	.[Finish]	-	\$72.00
Plate	1450T-18FC	.[Finish]	-	\$72.00
Shaft Cover	1450T-146	.[Finish]	-	\$9.00
Bumper Assembly	1450T-169	.[Finish]	-	\$26.00
Roller Lock Screw	1450T-425	-	-	\$9.00
Flat Box w/Label	1450T-Flat Box	-	-	\$9.00
Instruction Sheet	1450T-Instruction Sheet	-	-	\$7.00
Box and Instruction Sheet	1450T-Rebox Kit	-	-	\$9.00

👤 Handed

1460 Series	Specify			Price		
	Part number	Finish	Handing	Powder coat	652 plated	Other plated
Std Cylinder Assembly	1461-3071	.[Finish]	-	\$328.00	-	-
Delayed Action Cylinder Assembly	1461-3071DEL	.[Finish]	-	\$383.00	-	-
Reg Arm	1460-3077	.[Finish]	-	\$105.00	\$378.00	\$414.00
Reg Arm w/62PA	1460-3077/PA	.[Finish]	-	\$112.00	\$383.00	\$422.00
Reg Arm w/62A	1460-3077/62A	.[Finish]	-	\$130.00	\$402.00	\$440.00
Heavy Duty Arm	1460-3077HD	.[Finish]	-	\$149.00	\$422.00	\$459.00
HD Arm w/62PA	1460-3077HD/PA	.[Finish]	-	\$154.00	\$428.00	\$464.00
HD Arm w/62A	1460-3077HD/62A	.[Finish]	-	\$174.00	\$445.00	\$483.00
HD Long Arm	1460-3077HD/L	.[Finish]	-	\$154.00	\$428.00	\$464.00
Long Arm	1460-3077L	.[Finish]	-	\$105.00	\$378.00	\$414.00
Hold Open Arm	1460-3049	.[Finish]	-	\$144.00	\$414.00	\$451.00
H Arm w/62PA	1460-3049/PA	.[Finish]	-	\$149.00	\$422.00	\$459.00
H Long Arm	1460-3049L	.[Finish]	-	\$154.00	\$428.00	\$464.00
EDA Arm	1460-3077EDA	.[Finish]	-	\$174.00	\$445.00	\$483.00
EDA Arm w/62G	1460-3077EDA/G	.[Finish]	-	\$186.00	\$459.00	\$495.00
 H EDA Arm	1460-3049EDA	.[Finish]	.[Handing]	\$216.00	\$489.00	\$526.00
 H EDA Arm w/62G	1460-3049EDA/G	.[Finish]	.[Handing]	\$229.00	\$501.00	\$539.00
Cush Arm	1460-3077CNS	.[Finish]	-	\$216.00	\$489.00	\$526.00
H Cush Arm	1460-3049CNS	.[Finish]	-	\$291.00	\$563.00	\$599.00
S Cush Arm	1460-3077SCNS	.[Finish]	-	\$291.00	\$563.00	\$599.00
Spring H Cush Arm	1460-3049SCNS	.[Finish]	-	\$365.00	\$638.00	\$675.00
Standard Cover	1460-72	.[Finish]	-	\$18.00	-	-
Designer Series Cover	1460-72DS1	.[Finish]	-	\$55.00	\$204.00	\$253.00
Full Cover	1460-72FC	.[Finish]	-	\$31.00	-	-
Screw Pack	1460-SRT	.[Finish]	-	\$31.00	-	-
Screw Pack	1460-TBSRT	.[Finish]	-	\$31.00	\$55.00	\$73.00
Screw Pack	1460-WMS	.[Finish]	-	\$31.00	\$55.00	\$73.00
Screw Pack	1460-TBWMS	.[Finish]	-	\$31.00	\$55.00	\$73.00
Screw Pack	1460-TORX	.[Finish]	-	\$49.00	\$71.00	\$90.00
Screw Pack	1460-TBTRX	.[Finish]	-	\$49.00	\$71.00	\$90.00
Plate	1460-18	.[Finish]	-	\$73.00	-	-
Plate	1460-18DS	.[Finish]	-	\$73.00	\$260.00	\$298.00
Plate	1460-18FC	.[Finish]	-	\$73.00	-	-
Plate	1460-18PA	.[Finish]	-	\$73.00	-	-
Plate	1460-18PADS	.[Finish]	-	\$73.00	\$260.00	\$298.00
Plate	1460-18PAFC	.[Finish]	-	\$73.00	-	-
Cush Shoe Support	1460-30	.[Finish]	-	\$26.00	\$81.00	\$118.00
Mounting Bracket	1460-30A	.[Finish]	-	\$11.00	-	-
Hold Open Stud	1460-37	.[Finish]	-	\$31.00	-	-
Hold Open Nut	1460-41	.[Finish]	-	\$9.00	-	-
Hold Open Shoe	1460-45	.[Finish]	-	\$26.00	-	-
Hold Open Main Arm	1460-49	.[Finish]	-	\$81.00	-	-
Spacer	1460-61	.[Finish]	-	\$31.00	\$86.00	\$123.00
Auxiliary Shoe	1460-62A	.[Finish]	-	\$50.00	\$123.00	\$161.00

 Handed

PARTS AND ACCESSORIES

Powder coat

622	Matte Black (MTBLK)
689	Aluminum (AL)
690	Statuary Bronze (STAT)
691	Light Bronze (LTBRZ)
693	Black (GLBLK)
695	Dark Bronze (DKBRZ)
696	Brass (BRASS)

Plated

616	Satin Bronze, Blackened (US11)
632	Brass (US3)
633	Satin Brass (US4)
639	Satin Bronze (US10)
646	Satin Nickel (US15)
651	Bright Chrome (US26)
652	Satin Chrome (US26D)

Anodized

628	Aluminum (ANCLR)
710	Dark Bronze (ANDKB)

Handing

RH	Right hand
LH	Left hand

1460 Series	Specify			Price		
	Part number	Finish	Handing	Powder coat	652 plated	Other plated
PA Shoe	1460-62PA	.[Finish]	-	\$19.00	\$112.00	\$149.00
Arm and Forearm	1460-77	.[Finish]	-	\$105.00	-	-
Heavy Duty Arm and Forearm	1460-77HD	.[Finish]	-	\$144.00	-	-
H Head and Tube	1460-78H	.[Finish]	-	\$86.00	-	-
Head and Long Tube	1460-78HL	.[Finish]	-	\$93.00	-	-
Rod and Shoe	1460-79	.[Finish]	-	\$37.00	\$93.00	\$130.00
Long Rod and Shoe	1460-79LR	.[Finish]	-	\$37.00	\$93.00	\$130.00
Arm Screw	1460-83	.[Finish]	-	\$7.00	-	-
H Arm Screw	1460-83H	.[Finish]	-	\$7.00	-	-
Plug	1460-124	.[Finish]	-	\$7.00	-	-
Shaft Cover	1460-146	.[Finish]	-	\$9.00	-	-
Arm Screw	1460-159	.[Finish]	-	\$7.00	-	-
Arm Insert	1460-163	.[Finish]	-	\$7.00	-	-
Spacer	1460-201	-	-	\$9.00	-	-
Stop	1460-384	.[Finish]	-	\$26.00	-	-
Panel Adapter	1460-419	.[Finish]	-	\$81.00	\$186.00	\$224.00
Head and Tube Assembly	1460-3048	.[Finish]	-	\$105.00	\$198.00	\$235.00
Head and Long Tube Assembly	1460-3048L	.[Finish]	-	\$105.00	\$198.00	\$235.00
Spring Cush Block	1460-3080	.[Finish]	-	\$73.00	-	-
Adapter Kit	1460-3373	.[Finish]	-	\$9.00	-	-
Flat Box w/Label	1460-Flat Box	-	-	\$9.00	-	-
Instruction Sheet	1460-Instruction Sheet	-	-	\$7.00	-	-
Box and Instruction Sheet	1460-Rebox Kit	-	-	\$9.00	-	-

1460T Series	Specify			Price		
	Part number	Finish	Handing	Powder coat	652 plated	Other plated
Std Cylinder Assembly	1460T-3071	.[Finish]	-	\$328.00	-	-
Std Cylinder Assembly	1461T-3071	.[Finish]	-	\$328.00	-	-
Standard Arm	1460T-3077T	.[Finish]	-	\$112.00	\$284.00	\$334.00
Standard Track	1460T-3038	.[Finish]	-	\$93.00	-	-
Track w/Bumper	1460T-3038B	.[Finish]	-	\$98.00	-	-
Track w/Hold Open	1460T-3038H	.[Finish]	-	\$123.00	-	-
Track w/Hold Open and Bumper	1460T-3038HB	.[Finish]	-	\$135.00	-	-
Standard Cover	1460T-72	.[Finish]	-	\$18.00	-	-
Designer Series Cover	1460T-72DS1	.[Finish]	-	\$55.00	\$204.00	\$253.00
Full Cover	1460T-72FC	.[Finish]	-	\$31.00	-	-
Screw Pack (incl -3034)	1460T-SRT	.[Finish]	-	\$63.00	-	-

☞ Handed

1460T Series	Specify			Price		
	Part number	Finish	Handing	Powder coat	652 plated	Other plated
Screw Pack (incl -3034)	1460T-TBSRT	.[Finish]	-	\$63.00	\$86.00	\$105.00
Screw Pack (incl -3034)	1460T-WMS	.[Finish]	-	\$63.00	\$86.00	\$105.00
Screw Pack (incl -3034)	1460T-TBWMS	.[Finish]	-	\$63.00	\$86.00	\$105.00
Screw Pack (incl -3034)	1460T-TORX	.[Finish]	-	\$79.00	\$102.00	\$120.00
Screw Pack (incl -3034)	1460T-TBTRX	.[Finish]	-	\$79.00	\$102.00	\$120.00
HO Screw Pack (incl -3034H)	1460T-HSRT	.[Finish]	-	\$63.00	-	-
HO Screw Pack (incl -3034H)	1460T-HTBSRT	.[Finish]	-	\$63.00	-	-
HO Screw Pack (incl -3034H)	1460T-HWMS	.[Finish]	-	\$63.00	\$86.00	\$105.00
HO Screw Pack (incl -3034H)	1460T-HTBWMS	.[Finish]	-	\$63.00	\$86.00	\$105.00
HO Screw Pack (incl -3034H)	1460T-HTORX	.[Finish]	-	\$79.00	\$102.00	\$120.00
HO Screw Pack (incl -3034H)	1460T-HTBTRX	.[Finish]	-	\$79.00	\$102.00	\$120.00
Plate	1460T-18	.[Finish]	-	\$73.00	-	-
Plate	1460T-18DS	.[Finish]	-	\$73.00	\$260.00	\$298.00
Plate	1460T-18FC	.[Finish]	-	\$73.00	-	-
Plate	1460T-18PA	.[Finish]	-	\$73.00	-	-
Plate	1460T-18PADS	.[Finish]	-	\$73.00	\$260.00	\$298.00
Plate	1460T-18PAFC	.[Finish]	-	\$73.00	-	-
Mounting Bracket	1460T-30A	.[Finish]	-	\$11.00	-	-
End Cap	1460T-73	-	-	\$14.00	-	-
Arm and Tube	1460T-78	.[Finish]	-	\$93.00	-	-
Rod	1460T-82	.[Finish]	-	\$73.00	-	-
H Arm Screw	1460T-83H	.[Finish]	-	\$7.00	-	-
Plug	1460T-141-1	.[Finish]	-	\$7.00	-	-
Plug	1460T-141-2	.[Finish]	-	\$7.00	-	-
Shaft Cover	1460T-146	.[Finish]	-	\$9.00	-	-
Arm Screw	1460T-159	.[Finish]	-	\$7.00	-	-
Arm Insert	1460T-163	.[Finish]	-	\$7.00	-	-
Bumper Assembly	1460T-169	-	-	\$26.00	-	-
Roller Lock Screw	1460T-425	-	-	\$9.00	-	-
Track Roller	1460T-3034	-	-	\$37.00	-	-
Hold Open Track Roller	1460T-3034H	-	-	\$37.00	-	-
Hold Open Clip	1460T-3054	-	-	\$37.00	-	-
Flat Box w/Label	1460T-Flat Box	-	-	\$9.00	-	-
Instruction Sheet	1460T-Instruction Sheet	-	-	\$7.00	-	-
Box and Instruction Sheet	1460T-Rebox Kit	-	-	\$9.00	-	-

Handed

1000 SERIES
4000 SERIES
CONCEALED
FIRE/LIFE SAFETY
HIGH SECURITY
AUTO OPERATORS
ACTUATORS, ACCESSORIES
MISC.



1000 SERIES

4000 SERIES

CONCEALED

FIRE/LIFE SAFETY

HIGH SECURITY

AUTO OPERATORS

ACTUATORS, ACCESSORIES

MISC.





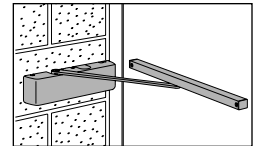

this page intentionally blank

4000T SERIES 

The 4000T is a heavy duty closer to reliably control fire and smoke barrier doors with maximum swing of 90°. Designed for use with an SEM 7850 wall magnet.



622	689	690	691	693	695	696	652	616	632	633	639	646	651
MTBLK	AL	STAT	LTBRZ	GLBLK	DKBRZ	BRASS	US26D	US11	US3	US4	US10	US15	US26

ACN for these commonly ordered products		PRICE BASED ON FINISH					
		POWDER COAT		PLATED (INCLUDES METAL COVER)			
		622	689	690	616 	632 	
		691	693	695	652 	633 	639 
		696			646 	651 	
DEFAULT CONFIGURATIONS							
Model	Finish						
[4003T or 4004T]	[Finish]	\$701.00	\$1,207.00	\$1,305.00			

DEFAULT AND COMMON CONFIGURATIONS

Pricing includes default options shown below unless otherwise specified. Specification rules, additional options and pricing adders are shown in the tables below.

Cylinder
Cast Iron Cylinder Assembly (CYL)

Arm type
Standard Arm (STDTRKARM)

Track type
Standard Track (STDTRK)

Cover
Plastic Cover (PC)

Plated prices include a Metal Cover and requires handing.

Screw package
Wood and Machine Screws (WMS)

BAA Compliant
See the [Allegion Buy America/ Buy American and Trade Agreement Acts \(BAA and TAA\) Compliance Guide](#) for full details

SPECIFICATION RULES, ADDITIONAL OPTIONS AND PRICING ADDERS

Order of attributes when placing an order for a non-standard configuration. See parts section for individual parts pricing. Attributes show in CAPS are required. Other attributes are required only if you are deviating from the product's default.

MODEL . FINISH . Special rust inhibitor . Cover . Handing . Screw package . Door thickness

Custom powder coat finishes	Specify	Price adder
Apply price adder to powder coat price		
Custom Power Coat Finish - Requires metal cover	RAL []	\$50.00
Brite Metallic Powder Coat - Requires metal cover	MTLPC	\$73.00
Special rust inhibiting primer	Specify	Price adder
Special Rust Inhibitor for Powder Coat Finishes	SRI	\$50.00
Cover	Specify	Price adder
Plastic Cover (PC) - Default	-	-
 Metal Cover - Included for plated finishes	MC	\$19.00

Screw package	Specify	Price adder
Wood and Machine Screws (WMS) - Default	-	-
Through Bolt Wood and Machine Screws	TBWMS	\$0.00
Torx Machine Screws	TORX	\$16.00
Through Bolt and Torx Machine Screws	TBTRX	\$16.00
Door thickness	Price adder	
Specify if door thickness is different than 1-3/4" when choosing a through bolt screw pack	[]	

 Handing required

 Indicates products that have EPD documentation available and meet LEED v4.

4010 SERIES

The 4010 is LCN's best performing heavy duty closer designed specifically for institutional and other rugged high traffic applications.

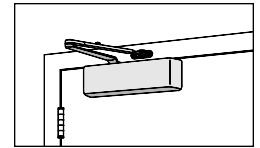

622	689	690	691	693	695	696	652	616	632	633	639	646	651
MTBLK	AL	STAT	LTBRZ	GLBLK	DKBRZ	BRASS	US26D	US11	US3	US4	US10	US15	US26

ACN for these commonly ordered products	PRICE BASED ON FINISH				
	POWDER COAT		PLATED (INCLUDES METAL COVER)		
	622	689		616	632
	690	691	652	633	639
	693	695		646	651
	696				

DEFAULT CONFIGURATIONS					
Model	Arm	Finish	Handing		
[4011 or 4016]	REGARM	[Finish]	[RH, LH]	\$613.00	\$1,122.00
[4011 or 4016]	H	[Finish]	[RH, LH]	\$680.00	\$1,189.00
[4011 or 4016]	FL	[Finish]	[RH, LH]	\$798.00	N/A

ADDITIONAL COMMON CONFIGURATIONS					
Model	Arm	Finish	Cover	Handing	
[4011 or 4016]	REGARM	[Finish]	MC	[RH, LH]	\$632.00

Note: 4010 Series is available as 4011 (adjustable 1-5) or 4016 (size 6 only - not for ADA required applications).

DEFAULT AND COMMON CONFIGURATIONS
 Pricing includes default options shown below unless otherwise specified. Specification rules, additional options and pricing adders are shown in the tables below.

Cylinder
 Cast Iron Cylinder Assembly (CYL)

Cover
 Plastic Cover (PC)

Screw package
 Self Reaming Tap Screws (SRT)

BAA Compliant
 See the [Allegion Buy America/ Buy American and Trade Agreement Acts \(BAA and TAA\) Compliance Guide](#) for full details

SPECIFICATION RULES, ADDITIONAL OPTIONS AND PRICING ADDERS

Order of attributes when placing an order for a non-standard configuration. See parts section for individual parts pricing. Attributes show in CAPS are required. Other attributes are required only if you are deviating from the product's default.

MODEL . Cylinder . ARM TYPE . FINISH . Special rust inhibitor . Cover . HANDING . Screw package . Door thickness

Cylinder	Specify	Price adder
Cast Iron Cylinder Assembly (CYL) - Default	-	-
Delay Action Cylinder (4011 only)	CYLDEL	\$55.00
Telephone Booth Cylinder	CYLTEL	\$55.00
Custom powder coat finishes	Specify	Price adder
Apply price adder to powder coat price		
Custom Power Coat Finish - Requires metal cover	RAL []	\$50.00
Brite Metallic Powder Coat - Requires metal cover	MTLPC	\$73.00
Special rust inhibiting primer	Specify	Price adder
Special Rust Inhibitor for Powder Coat Finishes	SRI	\$50.00
Cover	Specify	Price adder
Plastic Cover (PC) - Default	-	-
Metal Cover - Included for plated finishes	MC	\$19.00

Screw package	Specify	Price adder
Self Reaming Tap Screws (SRT) - Default	-	-
Through Bolt Self Reaming and Tapping Screws	TBSRT	\$0.00
Wood and Machine Screws	WMS	\$0.00
Through Bolt Wood and Machine Screws	TBWMS	\$0.00
Torx Machine Screws	TORX	\$16.00
Through Bolt and Torx Machine Screws	TBTRX	\$16.00
Door thickness	Specify	
Specify if door thickness is different than 1-3/4" when choosing a through bolt screw pack	[]	

☞ Handing required

☞ Indicates products that have EPD documentation available and meet LEED v4.





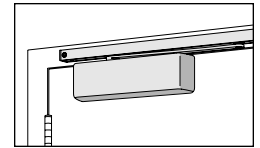



4010T SERIES 

The 4010T is LCN's best performing heavy duty track closer designed specifically for interior doors in institutional and other rugged high traffic applications.



622	689	690	691	693	695	696	652	616	632	633	639	646	651
MTBLK	AL	STAT	LTBRZ	GLBLK	DKBRZ	BRASS	US26D	US11	US3	US4	US10	US15	US26

ACN for these commonly ordered products	PRICE BASED ON FINISH				
	POWDER COAT		PLATED (INCLUDES METAL COVER)		
	622	689	652	616	632
	690	691		633	639
	693	695		646	651
	696				

DEFAULT CONFIGURATIONS					
Model	Track	Finish	Handing		
 [4011T, 4013T, 4014T]	STDTRK	[Finish]	[RH, LH]	\$701.00	\$1,207.00
 [4011T, 4013T, 4014T]	H	[Finish]	[RH, LH]	\$731.00	\$1,237.00
 [4011T, 4013T, 4014T]	BUMP	[Finish]	[RH, LH]	\$706.00	\$1,212.00
 [4011T, 4013T, 4014T]	HBMP	[Finish]	[RH, LH]	\$743.00	\$1,249.00
ADDITIONAL COMMON CONFIGURATIONS					
Model	Arm	Track	Finish	Handing	
 [4011T, 4013T, 4014T]	DE	STDTRK	[Finish]	[RH, LH]	\$743.00
 [4011T, 4013T, 4014T]	DE	H	[Finish]	[RH, LH]	\$773.00
 [4011T, 4013T, 4014T]	DE	BUMP	[Finish]	[RH, LH]	\$748.00
 [4011T, 4013T, 4014T]	DE	HBMP	[Finish]	[RH, LH]	\$785.00

DEFAULT AND COMMON CONFIGURATIONS

Pricing includes default options shown below unless otherwise specified. Specification rules, additional options and pricing adders are shown in the tables below.

Cylinder

Cast Iron Cylinder Assembly (CYL)

Cover

Plastic Cover (PC)

Screw package

STDTRK and BUMP tracks: Self Reaming Tap Screws (SRT);

H and HBMP tracks: Hold Open Self Reaming and Tapping Screws (HSRT)

BAA Compliant

See the [Allegion Buy America/ Buy American and Trade Agreement Acts \(BAA and TAA\) Compliance Guide](#) for full details

SPECIFICATION RULES, ADDITIONAL OPTIONS AND PRICING ADDERS

Order of attributes when placing an order for a non-standard configuration. See parts section for individual parts pricing. Attributes show in CAPS are required. Other attributes are required only if you are deviating from the product's default.

MODEL . Arm type . TRACK TYPE . FINISH . Special rust inhibitor . Cover . HANDING . Screw package . Door thickness

Custom powder coat finishes	Specify	Price adder
Apply price adder to powder coat price		
Custom Power Coat Finish - Requires metal cover	RAL []	\$50.00
Brite Metallic Powder Coat - Requires metal cover	MTLPC	\$73.00
Special rust inhibiting primer	Specify	Price adder
Special Rust Inhibitor for Powder Coat Finishes	SRI	\$50.00
Cover	Specify	Price adder
Plastic Cover (PC) - Default	-	-
 Metal Cover - Included for plated finishes	MC	\$19.00
Screw package	Specify	Price adder
Self Reaming Tap Screws (SRT) - Default	-	-
Through Bolt Self Reaming and Tapping Screws	TBSRT	\$0.00
Hold Open Self Reaming and Tapping Screws (HSRT) - Default	-	-

Screw package	Specify	Price adder
Hold Open Through Bolt Self Reaming and Tapping Screws	HTBSRT	\$0.00
Wood and Machine Screws	WMS	\$0.00
Through Bolt Wood and Machine Screws	TBWMS	\$0.00
Hold Open Wood and Machine Screws	HWMS	\$0.00
Hold Open Through Bolt Wood and Machine Screws	HTBWMS	\$0.00
Torx Machine Screws	TORX	\$16.00
Through Bolt and Torx Machine Screws	TBTRX	\$16.00
Hold Open Torx Screws	HTORX	\$16.00
Hold Open Through Bolt Torx Screws	HTBTX	\$16.00
Door thickness	Specify	
Specify if door thickness is different than 1-3/4" when choosing a through bolt screw pack	[]	

 Handing required

 Indicates products that have EPD documentation available and meet LEED v4.

4020 SERIES

The 4020 is a heavy duty closer with adjustable spring power using the LCN Green Dial. This creates a custom fit to meet the specific demands of high traffic use and brings reliable performance.

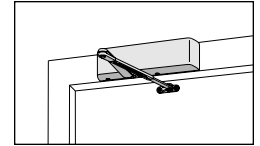

622	689	690	691	693	695	696	652	616	632	633	639	646	651
MTBLK	AL	STAT	LTBRZ	GLBLK	DKBRZ	BRASS	US26D	US11	US3	US4	US10	US15	US26

ACN for these commonly ordered products	PRICE BASED ON FINISH				
	POWDER COAT		PLATED (INCLUDES METAL COVER)		
	622	689	652	616	632
690	691	633		639	
693	695	646		651	
696					

DEFAULT CONFIGURATIONS							
Model	Arm	Finish	Handing				
[4021 or 4026]	REGARM	[Finish]	[RH, LH]		\$613.00	\$1,122.00	\$1,220.00
[4021 or 4026]	LONG	[Finish]	[RH, LH]		\$618.00	\$1,128.00	\$1,225.00
[4021 or 4026]	H	[Finish]	[RH, LH]		\$680.00	\$1,189.00	\$1,287.00
[4021 or 4026]	FL	[Finish]	[RH, LH]		\$798.00	N/A	N/A

DEFAULT AND COMMON CONFIGURATIONS

Pricing includes default options shown below unless otherwise specified. Specification rules, additional options and pricing adders are shown in the tables below.

Cylinder
Cast Iron Cylinder Assembly (CYL)

Cover
Plastic Cover (PC)

Screw package
Self Reaming Tap Screws (SRT)

BAA Compliant
See the [Allegion Buy America/ Buy American and Trade Agreement Acts \(BAA and TAA\) Compliance Guide](#) for full details

SPECIFICATION RULES, ADDITIONAL OPTIONS AND PRICING ADDERS

Order of attributes when placing an order for a non-standard configuration. See parts section for individual parts pricing. Attributes show in CAPS are required. Other attributes are required only if you are deviating from the product's default.

MODEL . Cylinder . ARM TYPE . FINISH . Special rust inhibitor . Cover . HANDING . Screw package . Door thickness

Cylinder	Specify	Price adder
Cast Iron Cylinder Assembly (CYL) - Default	-	-
Delay Action Cylinder (4021 only)	CYLDEL	\$55.00
Telephone Booth Cylinder	CYLTEL	\$55.00
Custom powder coat finishes	Specify	Price adder
Apply price adder to powder coat price		
Custom Power Coat Finish - Requires metal cover	RAL []	\$50.00
Brite Metallic Powder Coat - Requires metal cover	MTLPC	\$73.00
Special rust inhibiting primer	Specify	Price adder
Special Rust Inhibitor for Powder Coat Finishes	SRI	\$50.00
Cover	Specify	Price adder
Plastic Cover (PC) - Default	-	-
Metal Cover - Included for plated finishes	MC	\$19.00

Screw package	Specify	Price adder
Self Reaming Tap Screws (SRT) - Default	-	-
Through Bolt Self Reaming and Tapping Screws	TBSRT	\$0.00
Wood and Machine Screws	WMS	\$0.00
Through Bolt Wood and Machine Screws	TBWMS	\$0.00
Torx Machine Screws	TORX	\$16.00
Through Bolt and Torx Machine Screws	TBTRX	\$16.00
Door thickness	Specify	
Specify if door thickness is different than 1-3/4" when choosing a through bolt screw pack	[]	





☞ Handing required

☞ Indicates products that have EPD documentation available and meet LEED v4.

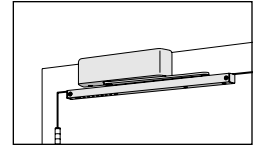
4020T SERIES 

The 4020T is a cast iron, heavy duty closer designed for interior, high traffic conditions. This Grade 1 device comes in various finishes and colors to match your interior look.



622	689	690	691	693	695	696	652	616	632	633	639	646	651
MTBLK	AL	STAT	LTBRZ	GLBLK	DKBRZ	BRASS	US26D	US11	US3	US4	US10	US15	US26
ACN for these commonly ordered products								POWDER COAT		PLATED (INCLUDES METAL COVER)			
								622	689	652	616	632	
								690	691		633	639	
								693	695		646	651	
								696					
DEFAULT CONFIGURATIONS													
Model . Track . Finish . Handing													
 [4021T, 4023T, 4024T] . STDTRK . [Finish] . [RH, LH]								\$701.00	\$1,207.00	\$1,305.00			
 [4021T, 4023T, 4024T] . H . [Finish] . [RH, LH]								\$731.00	\$1,237.00	\$1,335.00			
 [4021T, 4023T, 4024T] . BUMP . [Finish] . [RH, LH]								\$706.00	\$1,212.00	\$1,310.00			
 [4021T, 4023T, 4024T] . HBMP . [Finish] . [RH, LH]								\$743.00	\$1,249.00	\$1,347.00			

DEFAULT AND COMMON CONFIGURATIONS

Pricing includes default options shown below unless otherwise specified. Specification rules, additional options and pricing adders are shown in the tables below.

Cylinder

Cast Iron Cylinder Assembly (CYL)

Arm type

Standard Arm (STDTRKARM)

Cover

Plastic Cover (PC)

Screw package

STDTRK and BUMP tracks: Self Reaming Tap Screws (SRT);

H and HBMP tracks: Hold Open Self Reaming and Tapping Screws (HSRT)



BAA Compliant

See the [Allegion Buy America/ Buy American and Trade Agreement Acts \(BAA and TAA\) Compliance Guide](#) for full details

SPECIFICATION RULES, ADDITIONAL OPTIONS AND PRICING ADDERS

Order of attributes when placing an order for a non-standard configuration. See parts section for individual parts pricing. Attributes show in CAPS are required. Other attributes are required only if you are deviating from the product's default.

MODEL . TRACK TYPE . FINISH . Special rust inhibitor . Cover . HANDING . Screw package . Door thickness

Custom powder coat finishes	Specify	Price adder
Apply price adder to powder coat price		
Custom Power Coat Finish - Requires metal cover	RAL []	\$50.00
Brite Metallic Powder Coat - Requires metal cover	MTLPC	\$73.00
Special rust inhibiting primer	Specify	Price adder
Special Rust Inhibitor for Powder Coat Finishes	SRI	\$50.00
Cover	Specify	Price adder
 Plastic Cover (PC) - Default	-	-
 Metal Cover - Included for plated finishes	MC	\$19.00
Screw package	Specify	Price adder
Self Reaming Tap Screws (SRT) - Default	-	-
Through Bolt Self Reaming and Tapping Screws	TBSRT	\$0.00
Hold Open Self Reaming and Tapping Screws (HSRT) - Default	-	-

Screw package	Specify	Price adder
Hold Open Through Bolt Self Reaming and Tapping Screws	HTBSRT	\$0.00
Wood and Machine Screws	WMS	\$0.00
Through Bolt Wood and Machine Screws	TBWMS	\$0.00
Hold Open Wood and Machine Screws	HWMS	\$0.00
Hold Open Through Bolt Wood and Machine Screws	HTBWMS	\$0.00
Torx Machine Screws	TORX	\$16.00
Through Bolt and Torx Machine Screws	TBTRX	\$16.00
Hold Open Torx Screws	HTORX	\$16.00
Hold Open Through Bolt Torx Screws	HTBTX	\$16.00
Door thickness	Specify	
Specify if door thickness is different than 1-3/4" when choosing a through bolt screw pack	[]	

 Handing required

 Indicates products that have EPD documentation available and meet LEED v4.

4030 SERIES

The 4030 is a cast iron, universal closer designed specifically for doors in moderate traffic conditions. This versatile closer compliments the rest of the heavy duty 4000 Series and offers the choice of three mountings and multiple arm options.

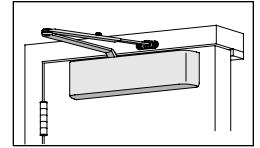

622	689	690	691	693	695	696	652	616	632	633	639	646	651
MTBLK	AL	STAT	LTBRZ	GLBLK	DKBRZ	BRASS	US26D	US11	US3	US4	US10	US15	US26

ACN for these commonly ordered products	PRICE BASED ON FINISH				
	POWDER COAT			PLATED	
	622	689	690	652	616
691	693	695	652	633	639
696				646	651

DEFAULT CONFIGURATIONS						
Model	Arm	Finish	Handing			
4031	REGARM	[Finish]		\$569.00	\$1,059.00	\$1,157.00
4031	RWPA	[Finish]		\$569.00	\$1,059.00	\$1,157.00
4031	RW62A	[Finish]		\$600.00	\$1,088.00	\$1,187.00
4031	LD	[Finish]		\$538.00	\$1,028.00	\$1,126.00
4031	LDPA	[Finish]		\$555.00	\$1,045.00	\$1,143.00
4031	LD62A	[Finish]		\$574.00	\$1,065.00	\$1,162.00
4031	LONG	[Finish]		\$574.00	\$1,065.00	\$1,162.00
4031	H	[Finish]		\$636.00	\$1,126.00	\$1,224.00
4031	HWA	[Finish]		\$649.00	\$1,138.00	\$1,237.00
4031	HLONG	[Finish]		\$649.00	\$1,138.00	\$1,237.00
4031	EDA	[Finish]		\$618.00	\$1,107.00	\$1,206.00
4031	HEDA	[Finish]	[RH, LH]	\$667.00	\$1,158.00	\$1,255.00
4031	CUSH	[Finish]		\$655.00	\$1,145.00	\$1,243.00
4031	HCUSH	[Finish]		\$741.00	\$1,231.00	\$1,329.00
4031	SCUSH	[Finish]		\$748.00	\$1,236.00	\$1,336.00
4031	SHCUSH	[Finish]		\$811.00	\$1,299.00	\$1,398.00

DEFAULT AND COMMON CONFIGURATIONS

Pricing includes default options shown below unless otherwise specified. Specification rules, additional options and pricing adders are shown in the tables below.

Cylinder
Cast Iron Cylinder Assembly (CYL)

Cover
Metal Cover (MC)

Screw package
Wood and Machine Screws (WMS)

BAA Compliant
See the [Allegion Buy America/ Buy American and Trade Agreement Acts \(BAA and TAA\) Compliance Guide](#) for full details

SPECIFICATION RULES, ADDITIONAL OPTIONS AND PRICING ADDERS

Order of attributes when placing an order for a non-standard configuration. See parts section for individual parts pricing. Attributes show in CAPS are required. Other attributes are required only if you are deviating from the product's default.

MODEL . ARM TYPE . FINISH . Special rust inhibitor . Handing . Screw package . Door thickness

Custom powder coat finishes	Specify	Price adder
Apply price adder to powder coat price		
Custom Power Coat Finish	RAL []	\$50.00
Brite Metallic Powder Coat	MTLPC	\$73.00
Special rust inhibiting primer	Specify	Price adder
Special Rust Inhibitor for Powder Coat Finishes	SRI	\$50.00
Screw package	Specify	Price adder
Wood and Machine Screws (WMS) - Default	-	-
Through Bolt Wood and Machine Screws	TBWMS	\$0.00
Door thickness	Specify	
Specify if door thickness is different than 1-3/4" when choosing a through bolt screw pack	[]	

☞ Handing required

☞ Indicates products that have EPD documentation available and meet LEED v4.

4030T SERIES 

The 4030T is a single lever (track) arm, surface mounted closer designed for interior use on narrow head frames and top rails. The choice of three mountings and ease of installation offer a versatile solution to door control in moderate traffic applications. The 4030T compliments the heavy duty 4000 Series.

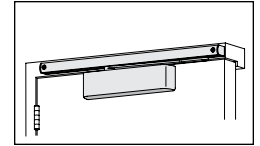

622	689	690	691	693	695	696	652	616	632	633	639	646	651
MTBLK	AL	STAT	LTBRZ	GLBLK	DKBRZ	BRASS	US26D	US11	US3	US4	US10	US15	US26

ACN for these commonly ordered products	PRICE BASED ON FINISH				
	POWDER COAT			PLATED	
	622	689	690	616	632
	691	693	695	652	633
	696			646	651
DEFAULT CONFIGURATIONS					
Model	Track	Finish			
4031T	STDTRK	[Finish]			
4031T	H	[Finish]			
		\$657.00	\$1,144.00	\$1,242.00	
		\$687.00	\$1,174.00	\$1,272.00	

DEFAULT AND COMMON CONFIGURATIONS

Pricing includes default options shown below unless otherwise specified. Specification rules, additional options and pricing adders are shown in the tables below.

Cylinder
Cast Iron Cylinder Assembly (CYL)

Army type
Standard Arm (STDTRKARM)

Cover
Metal Cover (MC)

Screw package
Wood and Machine Screws (WMS)

BAA Compliant
See the [Allegion Buy America/ Buy American and Trade Agreement Acts \(BAA and TAA\) Compliance Guide](#) for full details

SPECIFICATION RULES, ADDITIONAL OPTIONS AND PRICING ADDERS

Order of attributes when placing an order for a non-standard configuration. See parts section for individual parts pricing. Attributes show in CAPS are required. Other attributes are required only if you are deviating from the product's default.

MODEL . TRACK TYPE . FINISH . Special rust inhibitor . Handing . Screw package . Door thickness

Custom powder coat finishes	Specify	Price adder
Apply price adder to powder coat price		
Custom Power Coat Finish	RAL []	\$50.00
Brite Metallic Powder Coat	MTLPC	\$73.00
Special rust inhibiting primer	Specify	Price adder
Special Rust Inhibitor for Powder Coat Finishes	SRI	\$50.00
Screw package	Specify	Price adder
Wood and Machine Screws (WMS) - Default	-	-
Through Bolt Wood and Machine Screws	TBWMS	\$0.00
Door thickness	Specify	
Specify if door thickness is different than 1-3/4" when choosing a through bolt screw pack	[]	

 Handing required

 Indicates products that have EPD documentation available and meet LEED v4.

4040XP SERIES

The 4040XP is LCN's most durable and flexible heavy duty closer designed for institutional and other demanding high traffic applications.

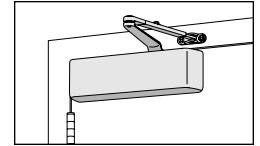

622	689	690	691	693	695	696	652	616	632	633	639	646	651
MTBLK	AL	STAT	LTBRZ	GLBLK	DKBRZ	BRASS	US26D	US11	US3	US4	US10	US15	US26

ACN for these commonly ordered products	PRICE BASED ON FINISH				
	POWDER COAT		PLATED (INCLUDES METAL COVER)		
	622	689	652	616	632
	690	691		633	639
693	695	646		651	
696					

DEFAULT AND COMMON CONFIGURATIONS

Pricing includes default options shown below unless otherwise specified. Specification rules, additional options and pricing adders are shown in the tables below.

Cylinder

Cast Iron Cylinder Assembly (CYL)

Cover

Plastic Cover (PC)

Plated prices include a Metal Cover and requires handing.

Screw package

Self Reaming Tap Screws (SRT)

BAA Compliant

See the [Allegion Buy America/ Buy American and Trade Agreement Acts \(BAA and TAA\) Compliance Guide](#) for full details

DEFAULT CONFIGURATIONS							
Model	Arm	Finish	Handing				
4040XP	REGARM	[Finish]		\$650.00	\$1,159.00	\$1,257.00	
4040XP	RWPA	[Finish]		\$650.00	\$1,159.00	\$1,257.00	
4040XP	LONG	[Finish]		\$655.00	\$1,165.00	\$1,262.00	
4040XP	XLONG	[Finish]		\$699.00	\$1,207.00	\$1,306.00	
4040XP	RW62A	[Finish]		\$681.00	\$1,188.00	\$1,287.00	
4040XP	H	[Finish]		\$717.00	\$1,226.00	\$1,324.00	
4040XP	HWPA	[Finish]		\$730.00	\$1,238.00	\$1,337.00	
4040XP	HLONG	[Finish]		\$730.00	\$1,238.00	\$1,337.00	
4040XP	EDA	[Finish]		\$699.00	\$1,207.00	\$1,306.00	
4040XP	EDAW62G	[Finish]		\$705.00	\$1,213.00	\$1,312.00	
4040XP	HEDA	[Finish]	[RH, LH]	\$748.00	\$1,258.00	\$1,355.00	
4040XP	HEDA62G	[Finish]	[RH, LH]	\$761.00	\$1,268.00	\$1,366.00	
4040XP	CUSH	[Finish]		\$736.00	\$1,245.00	\$1,343.00	
4040XP	HCUSH	[Finish]		\$822.00	\$1,331.00	\$1,429.00	
4040XP	SCUSH	[Finish]		\$829.00	\$1,336.00	\$1,436.00	
4040XP	SHCUSH	[Finish]		\$892.00	\$1,399.00	\$1,498.00	
ADDITIONAL COMMON CONFIGURATIONS							
Model	Arm	Finish	Cover	Handing			
4040XP	RW62A	[Finish]	MC	[RH, LH]	\$700.00	\$1,188.00	\$1,287.00
4040XP	EDA	[Finish]	MC	[RH, LH]	\$718.00	\$1,207.00	\$1,306.00
4040XP	RWPA	[Finish]	MC	[RH, LH]	\$669.00	\$1,159.00	\$1,257.00
Model	Arm	Finish	Screw pack				
4040XP	RWPA	[Finish]	TBSRT		\$650.00	\$1,159.00	\$1,257.00
4040XP	EDA	[Finish]	TBSRT		\$699.00	\$1,207.00	\$1,306.00
4040XP	CUSH	[Finish]	TBSRT		\$736.00	\$1,245.00	\$1,343.00
4040XP	HCUSH	[Finish]	TBSRT		\$822.00	\$1,331.00	\$1,429.00
4040XP	SCUSH	[Finish]	TBSRT		\$829.00	\$1,336.00	\$1,436.00
Model	Cylinder	Arm	Finish	Handing			
4041	CYLDEL	REGARM	[Finish]		\$706.00	\$1,215.00	\$1,313.00
4041	CYLDEL	RWPA	[Finish]		\$706.00	\$1,215.00	\$1,313.00
4041	CYLDEL	LONG	[Finish]		\$711.00	\$1,221.00	\$1,318.00

Handed

Handing required

Indicates products that have EPD documentation available and meet LEED v4.

4040XP SERIES

622	689	690	691	693	695	696	652	616	632	633	639	646	651
MTBLK	AL	STAT	LTBRZ	GLBLK	DKBRZ	BRASS	US26D	US11	US3	US4	US10	US15	US26

ACN for these commonly ordered products	PRICE BASED ON FINISH			
	POWDER COAT		PLATED (INCLUDES METAL COVER)	
	622	689	616	632
690	691	652	633	
693	695		639	
696			646	
			651	

Model	Cylinder	Arm	Finish	Handing			
4041	CYLDEL	XLONG	[Finish]		\$755.00	\$1,263.00	\$1,362.00
4041	CYLDEL	RW62A	[Finish]		\$737.00	\$1,244.00	\$1,343.00
4041	CYLDEL	H	[Finish]		\$773.00	\$1,282.00	\$1,380.00
4041	CYLDEL	HWPA	[Finish]		\$786.00	\$1,294.00	\$1,393.00
4041	CYLDEL	HLONG	[Finish]		\$786.00	\$1,294.00	\$1,393.00
4041	CYLDEL	EDA	[Finish]		\$755.00	\$1,263.00	\$1,362.00
4041	CYLDEL	EDAW62G	[Finish]		\$761.00	\$1,269.00	\$1,368.00
4041	CYLDEL	HEDA	[Finish]	[RH, LH]	\$804.00	\$1,314.00	\$1,411.00
4041	CYLDEL	HEDA62G	[Finish]	[RH, LH]	\$817.00	\$1,324.00	\$1,422.00
4041	CYLDEL	CUSH	[Finish]		\$792.00	\$1,301.00	\$1,399.00
4041	CYLDEL	HCUSH	[Finish]		\$878.00	\$1,387.00	\$1,485.00
4041	CYLDEL	SCUSH	[Finish]		\$885.00	\$1,392.00	\$1,492.00
4041	CYLDEL	SHCUSH	[Finish]		\$948.00	\$1,455.00	\$1,554.00

Handed

SPECIFICATION RULES, ADDITIONAL OPTIONS AND PRICING ADDERS

Order of attributes when placing an order for a non-standard configuration. See parts section for individual parts pricing. Attributes show in CAPS are required. Other attributes are required only if you are deviating from the product's default.

MODEL . Cylinder . ARM TYPE . FINISH . Special rust inhibitor . Cover . Handing . Screw package . Door thickness

Cylinder	Specify	Price adder
Cast Iron Cylinder Assembly (CYL) - Default	-	-
Delayed Action Cylinder (Model number when choosing delayed cylinder is 4041; price adder is included in complete closers shown on pages 32-33)	CYLDEL	\$56.00
Custom powder coat finishes	Specify	Price adder
Apply price adder to powder coat price		
Custom Power Coat Finish - Requires metal cover	RAL []	\$50.00
Brite Metallic Powder Coat - Requires metal cover	MTLPC	\$73.00
Special rust inhibiting primer	Specify	Price adder
Special Rust Inhibitor for Powder Coat Finishes	SRI	\$50.00
Cover	Specify	Price adder
Plastic Cover (PC) - Default	-	-
Handed Metal Cover - Included for plated finishes	MC	\$19.00

Screw package	Specify	Price adder
Self Reaming Tap Screws (SRT) - Default	-	-
Through Bolt Self Reaming and Tapping Screws	TBSRT	\$0.00
Wood and Machine Screws	WMS	\$0.00
Through Bolt Wood and Machine Screws	TBWMS	\$0.00
Torx Machine Screws	TORX	\$16.00
Through Bolt and Torx Machine Screws	TBTRX	\$16.00
Door thickness	Specify	
Specify if door thickness is different than 1-3/4" when choosing a through bolt screw pack	[]	

Handed

Handing required







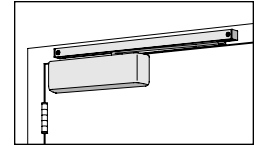

Indicates products that have EPD documentation available and meet LEED v4.





4040XPT SERIES 

The 4040XPT is a Grade 1 device featuring a cast iron body and Liquid X Fluid ideal for pull or push side placement in high traffic applications. Its high-quality construction provides for reliable performance.



622	689	690	691	693	695	696	652	616	632	633	639	646	651
MTBLK	AL	STAT	LTBRZ	GLBLK	DKBRZ	BRASS	US26D	US11	US3	US4	US10	US15	US26

ACN for these commonly ordered products	PRICE BASED ON FINISH				
	POWDER COAT		PLATED (INCLUDES METAL COVER)		
	622	689	616 	632 	639 
690	691	652 	633 	639 	
693	695		646 	651 	
696					

DEFAULT CONFIGURATIONS							
Model	Track	Finish					
4040XPT	STDTRK	[Finish]		\$738.00	\$1,244.00	\$1,342.00	
4040XPT	H	[Finish]		\$768.00	\$1,274.00	\$1,372.00	
4040XPT	BUMP	[Finish]		\$743.00	\$1,249.00	\$1,347.00	
4040XPT	HBMP	[Finish]		\$780.00	\$1,286.00	\$1,384.00	
ADDITIONAL COMMON CONFIGURATIONS							
Model	Arm	Track	Finish	Handing			
 4040XPT	DE	STDTRK	[Finish]	[RH, LH]	\$798.00	\$1,306.00	\$1,405.00
 4040XPT	DE	H	[Finish]	[RH, LH]	\$828.00	\$1,336.00	\$1,435.00
 4040XPT	DE	BUMP	[Finish]	[RH, LH]	\$803.00	\$1,311.00	\$1,410.00
 4040XPT	DE	HBMP	[Finish]	[RH, LH]	\$840.00	\$1,348.00	\$1,447.00

DEFAULT AND COMMON CONFIGURATIONS

Pricing includes default options shown below unless otherwise specified. Specification rules, additional options and pricing adders are shown in the tables below.

Cylinder
Cast Iron Cylinder Assembly (CYL)

Cover
Plastic Cover (PC)

Screw package
STDTRK and BUMP tracks: Self Reaming Tap Screws (SRT);

H and HBMP tracks: Hold Open Self Reaming and Tapping Screws (HSRT)

BAA Compliant
See the [Allegion Buy America/ Buy American and Trade Agreement Acts \(BAA and TAA\) Compliance Guide](#) for full details

 Handing required

 Indicates products that have EPD documentation available and meet LEED v4.

4040XPT SERIES 

SPECIFICATION RULES, ADDITIONAL OPTIONS AND PRICING ADDERS

Order of attributes when placing an order for a non-standard configuration. See parts section for individual parts pricing. Attributes show in CAPS are required. Other attributes are required only if you are deviating from the product's default.

MODEL . Arm type . TRACK TYPE . FINISH . Special rust inhibitor . Handling . Screw package . Door thickness

Custom powder coat finishes	Specify	Price adder
Apply price adder to powder coat price		
Custom Power Coat Finish - Requires metal cover	RAL []	\$50.00
Brite Metallic Powder Coat - Requires metal cover	MTLPC	\$73.00
Special rust inhibiting primer	Specify	Price adder
Special Rust Inhibitor for Powder Coat Finishes	SRI	\$50.00
Cover	Specify	Price adder
Plastic Cover (PC) - Default	-	-
 Metal Cover - Included for plated finishes	MC	\$19.00
Screw package	Specify	Price adder
Self Reaming Tap Screws (SRT) - Default	-	-
Through Bolt Self Reaming and Tapping Screws	TBSRT	\$0.00
Hold Open Self Reaming and Tapping Screws (HSRT) - Default	-	-
Hold Open Through Bolt Self Reaming and Tapping Screws	HTBSRT	\$0.00
Wood and Machine Screws	WMS	\$0.00
Through Bolt Wood and Machine Screws	TBWMS	\$0.00
Hold Open Wood and Machine Screws	HWMS	\$0.00
Hold Open Through Bolt Wood and Machine Screws	HTBWMS	\$0.00
Metric Wood and Machine Screws	MWMS	\$0.00
Metric Metal Through Bolt Machine Screws	MTBMS	\$0.00
Torx Machine Screws	TORX	\$16.00
Through Bolt and Torx Machine Screws	TBTRX	\$16.00
Hold Open Torx Screws	HTORX	\$16.00
Hold Open Through Bolt Torx Screws	HTBTX	\$16.00
Door thickness	Specify	
Specify if door thickness is different than 1-3/4" when choosing a through bolt screw pack	[]	

 Indicates products that have EPD documentation available and meet LEED v4.

4050A SERIES

The 4050A Series cast aluminum closer is engineered for durability and built tough to excel in the harsh environments of high frequency, high abusive traffic areas. Featuring the most common commercial footprint, it is ideal for commercial building applications that demand a combination of quality, reliability and value.

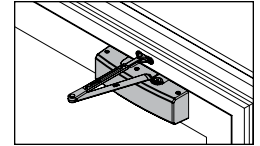

ACN for these commonly ordered products	PRICE BASED ON FINISH		
	POWDER COAT		
	622	689	690
	691	693	695
	696		

DEFAULT CONFIGURATIONS			
Model	Arm	Finish	Handing
4050A	RWPA	[Finish]	
4050A	LONG	[Finish]	
4050A	RW62A	[Finish]	
4050A	HWPA	[Finish]	
4050A	HLONG	[Finish]	
4050A	EDA	[Finish]	
4050A	EDAW62G	[Finish]	
4050A	HEDA	[Finish]	[RH, LH]
4050A	HEDA62G	[Finish]	[RH, LH]
4050A	CUSH	[Finish]	
4050A	HCUSH	[Finish]	
4050A	SCUSH	[Finish]	
4050A	SHCUSH	[Finish]	

622	689	690	691
MTBLK	AL	STAT	LTRZ

693	695	696
GLBLK	DKBRZ	BRASS

DEFAULT AND COMMON CONFIGURATIONS

Pricing includes default options shown below unless otherwise specified. Specification rules, additional options and pricing adders are shown in the tables below.

Cylinder
Cast Aluminum Cylinder Assembly (CYL)

Cover
Plastic Cover (PC)

Screw package
Self Reaming Tap Screws (SRT)

BAA Compliant
See the [Allegion Buy America/ Buy American and Trade Agreement Acts \(BAA and TAA\) Compliance Guide](#) for full details

SPECIFICATION RULES, ADDITIONAL OPTIONS AND PRICING ADDERS

Order of attributes when placing an order for a non-standard configuration. See parts section for individual parts pricing. Attributes show in CAPS are required. Other attributes are required only if you are deviating from the product's default.

MODEL . Cylinder . ARM TYPE . FINISH . Special rust inhibitor . Cover . Handing . Screw package . Door thickness

Cylinder	Specify	Price adder
Cast Aluminum Cylinder Assembly (CYL) - Default	-	-
Delayed Action Cylinder	CYLDEL	\$55.00
Custom powder coat finishes	Specify	Price adder
Apply price adder to powder coat price		
Custom Power Coat Finish - Requires metal cover	RAL []	\$50.00
Brite Metallic Powder Coat - Requires metal cover	MTLPC	\$73.00
Special rust inhibiting primer	Specify	Price adder
Special Rust Inhibitor for Powder Coat Finishes	SRI	\$50.00
Cover	Specify	Price adder
Plastic Cover (PC) - Default	-	-
☞ Metal Cover	MC	\$18.00

Screw package	Specify	Price adder
Self Reaming Tap Screws (SRT) - Default	-	-
Through Bolt Self Reaming and Tapping Screws	TBSRT	\$0.00
Wood and Machine Screws	WMS	\$0.00
Through Bolt Wood and Machine Screws	TBWMS	\$0.00
Torx Machine Screws	TORX	\$16.00
Through Bolt and Torx Machine Screws	TBTRX	\$16.00
Door thickness	Specify	
Specify if door thickness is different than 1-3/4" when choosing a through bolt screw pack	[]	

☞ Handing required

4050AT SERIES

The 4050AT cast aluminum heavy duty track closer is designed for rugged high frequency traffic areas. Ideal for commercial building applications and competitive specification situations that demand a combination of quality, reliability and value.

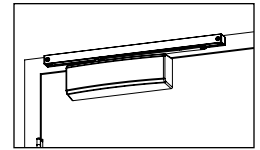

ACN for these commonly ordered products					PRICE BASED ON FINISH			
					POWDER COAT			
					622	689	690	691
					691	693	695	
					696			
DEFAULT CONFIGURATIONS								
Model	Track	Finish						
4050AT	STDTRK	[Finish]						\$626.00
4050AT	H	[Finish]						\$655.00
4050AT	BUMP	[Finish]						\$631.00
4050AT	HBMP	[Finish]						\$667.00
ADDITIONAL COMMON CONFIGURATIONS								
Model	Arm	Track	Finish	Handing				
☞ 4050AT	DE	STDTRK	[Finish]	[RH, LH]				\$670.00
☞ 4050AT	DE	H	[Finish]	[RH, LH]				\$699.00
☞ 4050AT	DE	BUMP	[Finish]	[RH, LH]				\$675.00
☞ 4050AT	DE	HBMP	[Finish]	[RH, LH]				\$711.00

622	689	690	691
MTBLK	AL	STAT	LTBRZ
693	695	696	
GLBLK	DKBRZ	BRASS	

DEFAULT AND COMMON CONFIGURATIONS

Pricing includes default options shown below unless otherwise specified. Specification rules, additional options and pricing adders are shown in the tables below.

Cylinder

Cast Aluminum Cylinder Assembly (CYL)

Cover

Plastic Cover (PC)

Screw package

STDTRK and BUMP tracks: Self Reaming Tap Screws (SRT);

H and HBMP tracks: Hold Open Self Reaming and Tapping Screws (HSRT)

BAA Compliant

See the [Allegion Buy America/ Buy American and Trade Agreement Acts \(BAA and TAA\) Compliance Guide](#) for full details

SPECIFICATION RULES, ADDITIONAL OPTIONS AND PRICING ADDERS

Order of attributes when placing an order for a non-standard configuration. See parts section for individual parts pricing. Attributes show in CAPS are required. Other attributes are required only if you are deviating from the product's default.

MODEL . Arm type . TRACK TYPE . FINISH . Special rust inhibitor . Cover . Handing . Screw package . Door thickness

Custom powder coat finishes	Specify	Price adder
Apply price adder to powder coat price		
Custom Power Coat Finish - Requires metal cover	RAL []	\$50.00
Brite Metallic Powder Coat - Requires metal cover	MTLPC	\$73.00
Special rust inhibiting primer	Specify	Price adder
Special Rust Inhibitor for Powder Coat Finishes	SRI	\$50.00
Cover	Specify	Price adder
Plastic Cover (PC) - Default	-	-
☞ Metal Cover	MC	\$18.00
Screw package	Specify	Price adder
Self Reaming Tap Screws (SRT) - Default	-	-
Through Bolt Self Reaming and Tapping Screws	TBSRT	\$0.00
Hold Open Self Reaming and Tapping Screws (HSRT) - Default	-	-

Screw package	Specify	Price adder
Hold Open Through Bolt Self Reaming and Tapping Screws	HTBSRT	\$0.00
Wood and Machine Screws	WMS	\$0.00
Through Bolt Wood and Machine Screws	TBWMS	\$0.00
Hold Open Wood and Machine Screws	HWMS	\$0.00
Hold Open Through Bolt Wood and Machine Screws	HTBWMS	\$0.00
Metric Wood and Machine Screws	MWMS	\$0.00
Metric Metal Through Bolt Machine Screws	MTBMS	\$0.00
Torx Machine Screws	TORX	\$16.00
Through Bolt and Torx Machine Screws	TBTRX	\$16.00
Hold Open Torx Screws	HTORX	\$16.00
Hold Open Through Bolt Torx Screws	HTBTX	\$16.00
Door thickness	Specify	
Specify if door thickness is different than 1-3/4" when choosing a through bolt screw pack	[]	

☞ Handing required

4110 SERIES

The 4110 is LCN's best performing heavy duty closer with an adjustable spring and possible hold open point beyond 140 degrees, meeting ADA requirements. Backed by a 30 year warranty, the cast iron body and all weather fluid offer versatility in high traffic applications.

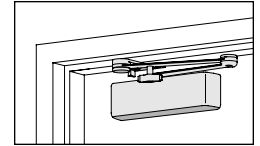

622	689	690	691	693	695	696	652	616	632	633	639	646	651
MTBLK	AL	STAT	LTBRZ	GLBLK	DKBRZ	BRASS	US26D	US11	US3	US4	US10	US15	US26

ACN for these commonly ordered products	PRICE BASED ON FINISH				
	POWDER COAT		PLATED (INCLUDES METAL COVER)		
	622	689	652	616	632
	690	691		633	639
	693	695		646	651
	696				

DEFAULT CONFIGURATIONS						
Model	Arm	Finish	Handing			
[4111 or 4116]	RW62A	[Finish]	[RH, LH]	\$613.00	\$1,120.00	\$1,219.00
[4111 or 4116]	EDA	[Finish]	[RH, LH]	\$631.00	\$1,139.00	\$1,238.00
[4111 or 4116]	EDAW62G	[Finish]	[RH, LH]	\$637.00	\$1,145.00	\$1,244.00
[4111 or 4116]	HEDA	[Finish]	[RH, LH]	\$680.00	\$1,190.00	\$1,287.00
[4111 or 4116]	HEDA62G	[Finish]	[RH, LH]	\$693.00	\$1,200.00	\$1,298.00
[4111 or 4116]	FL	[Finish]	[RH, LH]	\$767.00	N/A	N/A
[4111 or 4116]	CUSH	[Finish]	[RH, LH]	\$668.00	\$1,177.00	\$1,275.00
4111	HCUSH	[Finish]	[RH, LH]	\$754.00	\$1,263.00	\$1,361.00
[4111 or 4116]	SCUSH	[Finish]	[RH, LH]	\$761.00	\$1,268.00	\$1,368.00
4111	SHCUSH	[Finish]	[RH, LH]	\$824.00	\$1,331.00	\$1,430.00

Note: 4110 Series is available as 4111 (adjustable 1-5) or 4116 (size 6 only - not for ADA required applications).

DEFAULT AND COMMON CONFIGURATIONS

Pricing includes default options shown below unless otherwise specified. Specification rules, additional options and pricing adders are shown in the tables below.

Cylinder

Cast iron cylinder assembly (CYL)

Cover

Plastic Cover (PC)

Screw package

Self Reaming Tap Screws (SRT)

BAA Compliant

See the [Allegion Buy America/ Buy American and Trade Agreement Acts \(BAA and TAA\) Compliance Guide](#) for full details

SPECIFICATION RULES, ADDITIONAL OPTIONS AND PRICING ADDERS

Order of attributes when placing an order for a non-standard configuration. See parts section for individual parts pricing. Attributes show in CAPS are required. Other attributes are required only if you are deviating from the product's default.

MODEL . Cylinder . ARM TYPE . FINISH . Special rust inhibitor . Cover . HANDING . Screw package . Door thickness

Cylinder	Specify	Price adder
Cast iron cylinder assembly (CYL) - Default	-	-
Delayed Action Cylinder (4111 only)	CYLDEL	\$56.00
Telephone Booth Cylinder	CYLTEL	\$56.00
Advanced Variable Back Check	CYLAVB	\$31.00
Custom powder coat finishes Apply price adder to powder coat price	Specify	Price adder
Custom Power Coat Finish - Requires metal cover	RAL []	\$50.00
Brite Metallic Powder Coat - Requires metal cover	MTLPC	\$73.00
Special rust inhibiting primer	Specify	Price adder
Special Rust Inhibitor for Powder Coat Finishes	SRI	\$50.00
Cover	Specify	Price adder
Plastic Cover (PC) - Default	-	-
Metal Cover - Included for plated finishes	MC	\$19.00

Screw package	Specify	Price adder
Self Reaming Tap Screws (SRT) - Default	-	-
Through Bolt Self Reaming and Tapping Screws	TBSRT	\$0.00
Wood and Machine Screws	WMS	\$0.00
Through Bolt Wood and Machine Screws	TBWMS	\$0.00
Torx Machine Screws	TORX	\$16.00
Through Bolt and Torx Machine Screws	TBTRX	\$16.00
Door thickness	Specify	
Specify if door thickness is different than 1-3/4" when choosing a through bolt screw pack	[]	

☞ Handing required

☞ Indicates products that have EPD documentation available and meet LEED v4.



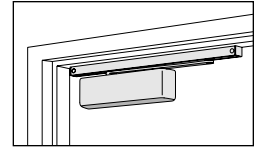

4110T SERIES 

The 4110T is a Grade 1 push side, mounting track closer designed for interior high traffic applications. It features an optional track bumper assembly for additional cushioning in the opening swing of the door.



622	689	690	691	693	695	696	652	616	632	633	639	646	651
MTBLK	AL	STAT	LTBRZ	GLBLK	DKBRZ	BRASS	US26D	US11	US3	US4	US10	US15	US26

ACN for these commonly ordered products	PRICE BASED ON FINISH				
	POWDER COAT		PLATED (INCLUDES METAL COVER)		
	622	689	652	616	632
690	691	633		639	
693	695	646		651	
696					

DEFAULT CONFIGURATIONS					
Model	Track	Finish	Handing		
 [4111T, 4113T or 4114T]	STDTRK	[Finish]	[RH, LH]	\$670.00	\$1,176.00
 [4111T, 4113T or 4114T]	H	[Finish]	[RH, LH]	\$700.00	\$1,206.00
 [4111T, 4113T or 4114T]	BUMP	[Finish]	[RH, LH]	\$675.00	\$1,181.00
 [4111T, 4113T or 4114T]	HBMP	[Finish]	[RH, LH]	\$712.00	\$1,218.00

DEFAULT AND COMMON CONFIGURATIONS

Pricing includes default options shown below unless otherwise specified. Specification rules, additional options and pricing adders are shown in the tables below.

Cylinder

Cast Iron Cylinder Assembly (CYL)

Arm type

Standard Arm (STDTRKARM)

Cover

Plastic Cover (PC)

Screw package

STDTRK and BUMP tracks: Self Reaming Tap Screws (SRT);

H and HBMP tracks: Hold Open Self Reaming and Tapping Screws (HSRT)

BAA Compliant

See the [Allegion Buy America/ Buy American and Trade Agreement Acts \(BAA and TAA\) Compliance Guide](#) for full details

SPECIFICATION RULES, ADDITIONAL OPTIONS AND PRICING ADDERS

Order of attributes when placing an order for a non-standard configuration. See parts section for individual parts pricing. Attributes show in CAPS are required. Other attributes are required only if you are deviating from the product's default.

MODEL . TRACK TYPE . FINISH . Special rust inhibitor . Cover . HANDING . Screw package . Door thickness

Custom powder coat finishes	Specify	Price adder
Apply price adder to powder coat price		
Custom Power Coat Finish - Requires metal cover	RAL []	\$50.00
Brite Metallic Powder Coat - Requires metal cover	MTLPC	\$73.00
Special rust inhibiting primer	Specify	Price adder
Special Rust Inhibitor for Powder Coat Finishes	SRI	\$50.00
Cover	Specify	Price adder
Plastic Cover (PC) - Default	-	-
 Metal Cover - Included for plated finishes	MC	\$19.00
Screw package	Specify	Price adder
Self Reaming Tap Screws (SRT) - Default	-	-
Through Bolt Self Reaming and Tapping Screws	TBSRT	\$0.00
Hold Open Self Reaming and Tapping Screws (HSRT) - Default	-	-

Screw package	Specify	Price adder
Hold Open Through Bolt Self Reaming and Tapping Screws	HTBSRT	\$0.00
Wood and Machine Screws	WMS	\$0.00
Through Bolt Wood and Machine Screws	TBWMS	\$0.00
Hold Open Wood and Machine Screws	HWMS	\$0.00
Hold Open Through Bolt Wood and Machine Screws	HTBWMS	\$0.00
Torx Machine Screws	TORX	\$16.00
Through Bolt and Torx Machine Screws	TBTRX	\$16.00
Hold Open Torx Screws	HTORX	\$16.00
Hold Open Through Bolt Torx Screws	HTBTX	\$16.00
Door thickness	Specify	
Specify if door thickness is different than 1-3/4" when choosing a through bolt screw pack	[]	

 Handing required

 Indicates products that have EPD documentation available and meet LEED v4.

PARTS AND ACCESSORIES

Powder coat

622	Matte Black (MTBLK)
689	Aluminum (AL)
690	Statuary Bronze (STAT)
691	Light Bronze (LTBRZ)
693	Black (GLBLK)
695	Dark Bronze (DKBRZ)
696	Brass (BRASS)

Plated

616	Satin Bronze, Blackened (US11)
632	Brass (US3)
633	Satin Brass (US4)
639	Satin Bronze (US10)
646	Satin Nickel (US15)
651	Bright Chrome (US26)
652	Satin Chrome (US26D)

Anodized

628	Aluminum (ANCLR)
710	Dark Bronze (ANDKB)

Handing

RH	Right hand
LH	Left hand

4000T Series	Specify			Price		
	Part number	Finish	Handing	Powder coat	652 plated	Other plated
Std Cylinder Assembly	4003(4)T-3071	.[Finish]	.Handing	\$433.00	-	-
Standard Arm	4000T-3077T	.[Finish]	-	\$144.00	\$414.00	\$451.00
Standard Track	4000T-3038	.[Finish]	-	\$93.00	-	-
Standard Cover	4000T-72	.[Finish]	-	\$31.00	-	-
Metal Cover	4000T-72MC	.[Finish]	.Handing	\$50.00	\$267.00	\$328.00
Screw Pack (incl -3034)	4000T-WMS	.[Finish]	-	\$63.00	\$86.00	\$105.00
Screw Pack (incl -3034)	4000T-TBWMS	.[Finish]	-	\$63.00	\$86.00	\$105.00
Screw Pack (incl -3034)	4000T-TORX	.[Finish]	-	\$79.00	\$102.00	\$120.00
Screw Pack (incl -3034)	4000T-TBTRX	.[Finish]	-	\$79.00	\$102.00	\$120.00
Cover Screw	4000T-31	.[Finish]	-	\$7.00	-	-
Spacer	4000T-61	-	-	\$19.00	-	-
End Cap	4000T-73	-	-	\$14.00	-	-
Plug	4000T-141-2	.[Finish]	-	\$7.00	-	-
Arm Screw	4000T-159	.[Finish]	-	\$7.00	-	-
Roller Lock Screw	4000T-425	-	-	\$9.00	-	-
Track Roller	4000T-3034	-	-	\$37.00	-	-
Flat Box w/Label	4000T-Flat Box	-	-	\$9.00	-	-
Instruction Sheet	4000T-Instruction Sheet	-	-	\$7.00	-	-
Box and Instruction Sheet	4000T-Rebox Kit	-	-	\$9.00	-	-

4010 Series	Specify			Price		
	Part number	Finish	Handing	Powder coat	652 plated	Other plated
Std Cylinder Assembly	4011(6)-3071	.[Finish]	.Handing	\$433.00	-	-
Delayed Action Cylinder Assembly	4011-3071DEL	.[Finish]	.Handing	\$488.00	-	-
TEL Cylinder Assembly	4011(6)-3071TEL	.[Finish]	.Handing	\$488.00	-	-
Reg Arm	4010-3077	.[Finish]	-	\$149.00	\$422.00	\$459.00
Hold Open Arm	4010-3049	.[Finish]	.Handing	\$216.00	\$489.00	\$526.00
FL Arm	4010-3049FL	.[Finish]	.Handing	\$334.00	-	-
Standard Cover	4010-72	.[Finish]	-	\$31.00	-	-
Metal Cover	4010-72MC	.[Finish]	.Handing	\$50.00	\$267.00	\$328.00
Screw Pack	4010-SRT	.[Finish]	-	\$31.00	-	-
Screw Pack	4010-TBSRT	.[Finish]	-	\$31.00	-	-
Screw Pack	4010-WMS	.[Finish]	-	\$31.00	\$55.00	\$73.00
Screw Pack	4010-TBWMS	.[Finish]	-	\$31.00	\$55.00	\$73.00
Screw Pack	4010-TORX	.[Finish]	-	\$49.00	\$71.00	\$90.00
Screw Pack	4010-TBTRX	.[Finish]	-	\$49.00	\$71.00	\$90.00
Plate	4010-18	.[Finish]	-	\$73.00	\$260.00	\$298.00

Handed

4010 Series	Specify			Price		
	Part number	Finish	Handing	Powder coat	652 plated	Other plated
Fusible Link	4010-28	-	-	\$16.00	-	-
Cover Screw	4010-31	.[Finish]	-	\$7.00	-	-
☞ Hold Open Stud	4010-37	.[Finish]	.Handing	\$31.00	-	-
☞ FL Hold Open Stud	4010-37FL	.[Finish]	.Handing	\$31.00	-	-
Hold Open Nut	4010-41	.[Finish]	-	\$10.00	-	-
Hold Open Forearm	4010-48	.[Finish]	-	\$86.00	-	-
☞ Hold Open Main Arm	4010-49	.[Finish]	.Handing	\$81.00	-	-
FL Main Arm and Rod	4010-49FL	.[Finish]	-	\$81.00	-	-
Arm and Forearm	4010-77	.[Finish]	-	\$149.00	-	-
Rod and Shoe	4010-79	.[Finish]	-	\$37.00	\$93.00	\$130.00
H Rod and Shoe	4010-79H	.[Finish]	-	\$37.00	\$93.00	\$130.00
Arm Screw	4010-83	.[Finish]	-	\$7.00	-	-
H Arm Screw	4010-83H	.[Finish]	-	\$7.00	-	-
Arm Stud	4010-95	.[Finish]	-	\$19.00	-	-
Metal Template	4010-107 REG	-	-	\$328.00	-	-
Arm Screw	4010-159	.[Finish]	-	\$7.00	-	-
Flat Box w/Label	4010-Flat Box	-	-	\$9.00	-	-
Instruction Sheet	4010-Instruction Sheet	-	-	\$7.00	-	-
Box and Instruction Sheet	4010-Rebox Kit	-	-	\$9.00	-	-

4010T Series	Specify			Price		
	Part number	Finish	Handing	Powder coat	652 plated	Other plated
☞ Std Cylinder Assembly	4011(3,4)T-3071	.[Finish]	.Handing	\$433.00	-	-
☞ Standard Arm	4010T-3077T	.[Finish]	.Handing	\$144.00	\$414.00	\$451.00
☞ DE Arm	4010T-3077DE	.[Finish]	.Handing	\$186.00	\$459.00	\$495.00
Standard Track	4010T-3038	.[Finish]	-	\$93.00	-	-
Track w/Bumper	4010T-3038B	.[Finish]	-	\$98.00	-	-
Track w/Hold Open	4010T-3038H	.[Finish]	-	\$123.00	-	-
Track w/Hold Open and Bumper	4010T-3038HB	.[Finish]	-	\$135.00	-	-
Standard Cover	4010T-72	.[Finish]	-	\$31.00	-	-
☞ Metal Cover	4010T-72MC	.[Finish]	.Handing	\$50.00	\$267.00	\$328.00
Screw Pack (incl -3034)	4010T-SRT	.[Finish]	-	\$63.00	-	-
Screw Pack (incl -3034)	4010T-TBSRT	.[Finish]	-	\$63.00	-	-
Screw Pack (incl -3034)	4010T-WMS	.[Finish]	-	\$63.00	\$86.00	\$105.00
Screw Pack (incl -3034)	4010T-TBWMS	.[Finish]	-	\$63.00	\$86.00	\$105.00
Screw Pack (incl -3034)	4010T-TORX	.[Finish]	-	\$79.00	\$102.00	\$120.00
Screw Pack (incl -3034)	4010T-TBTRX	.[Finish]	-	\$79.00	\$102.00	\$120.00
HO Screw Pack (incl -3034H)	4010T-HSRT	.[Finish]	-	\$63.00	-	-
HO Screw Pack (incl -3034H)	4010T-HTBSRT	.[Finish]	-	\$63.00	-	-
HO Screw Pack (incl -3034H)	4010T-HWMS	.[Finish]	-	\$63.00	\$86.00	\$105.00
HO Screw Pack (incl -3034H)	4010T-HTBWMS	.[Finish]	-	\$63.00	\$86.00	\$105.00
HO Screw Pack (incl -3034H)	4010T-HTORX	.[Finish]	-	\$79.00	\$102.00	\$120.00
HO Screw Pack (incl -3034H)	4010T-HTBTRX	.[Finish]	-	\$79.00	\$102.00	\$120.00
Plate	4010T-18	.[Finish]	-	\$73.00	\$260.00	\$298.00

☞ Handed

1000 SERIES
 4000 SERIES
 CONCEALED
 FIRE/LIFE SAFETY
 HIGH SECURITY
 AUTO OPERATORS
 ACTUATORS, ACCESSORIES
 MISC.

PARTS AND ACCESSORIES

Powder coat

622	Matte Black (MTBLK)
689	Aluminum (AL)
690	Statuary Bronze (STAT)
691	Light Bronze (LTBRZ)
693	Black (GLBLK)
695	Dark Bronze (DKBRZ)
696	Brass (BRASS)

Plated

616	Satin Bronze, Blackened (US11)
632	Brass (US3)
633	Satin Brass (US4)
639	Satin Bronze (US10)
646	Satin Nickel (US15)
651	Bright Chrome (US26)
652	Satin Chrome (US26D)

Anodized

628	Aluminum (ANCLR)
710	Dark Bronze (ANDKB)

Handing

RH	Right hand
LH	Left hand

4010T Series	Specify			Price		
	Part number	Finish	Handing	Powder coat	652 plated	Other plated
Cover Screw	4010T-31	.[Finish]	-	\$7.00	-	-
End Cap	4010T-73	-	-	\$14.00	-	-
☛ Main Arm and Tube	4010T-78DE	.[Finish]	.Handing	\$98.00	-	-
Rod	4010T-82	.[Finish]	-	\$73.00	-	-
H Arm Screw	4010T-83H	.[Finish]	-	\$7.00	-	-
Plug	4010T-141-2	.[Finish]	-	\$7.00	-	-
Arm Screw	4010T-159	.[Finish]	-	\$7.00	-	-
Bumper Assembly	4010T-169	-	-	\$26.00	-	-
Roller Lock Screw	4010T-425	-	-	\$9.00	-	-
Track Roller	4010T-3034	-	-	\$37.00	-	-
HO Track Roller	4010T-3034H	-	-	\$37.00	-	-
Hold Open Clip	4010T-3054	.[Finish]	-	\$37.00	-	-
Hold open Clip and Roller	4010T-3064H	-	-	\$73.00	-	-
Flat Box w/Label	4010T-Flat Box	-	-	\$9.00	-	-
Instruction Sheet	4010T-Instruction Sheet	-	-	\$7.00	-	-
Box and Instruction Sheet	4010T-Rebox Kit	-	-	\$9.00	-	-

4020 Series	Specify			Price		
	Part number	Finish	Handing	Powder coat	652 plated	Other plated
☛ Std Cylinder Assembly	4021(6)-3071	.[Finish]	.Handing	\$433.00	-	-
☛ Delayed Action Cylinder Assembly	4021-3071DEL	.[Finish]	.Handing	\$488.00	-	-
☛ TEL Cylinder Assembly	4021(6)-3071TEL	.[Finish]	.Handing	\$488.00	-	-
Reg Arm	4020-3077	.[Finish]	-	\$149.00	\$422.00	\$459.00
Long Arm	4020-3077L	.[Finish]	-	\$154.00	\$428.00	\$464.00
☛ Hold Open Arm	4020-3049	.[Finish]	.Handing	\$216.00	\$489.00	\$526.00
☛ FL Arm	4020-3049FL	.[Finish]	.Handing	\$334.00	-	-
☛ Standard Cover	4020-72	.[Finish]	.Handing	\$31.00	-	-
☛ Metal Cover	4020-72MC	.[Finish]	.Handing	\$50.00	\$267.00	\$328.00
Screw Pack	4020-SRT	.[Finish]	-	\$31.00	-	-
Screw Pack	4020-TBSRT	.[Finish]	-	\$31.00	-	-
Screw Pack	4020-WMS	.[Finish]	-	\$31.00	\$55.00	\$73.00
Screw Pack	4020-TBWMS	.[Finish]	-	\$31.00	\$55.00	\$73.00
Screw Pack	4020-TORX	.[Finish]	-	\$49.00	\$71.00	\$90.00
Screw Pack	4020-TBTRX	.[Finish]	-	\$49.00	\$71.00	\$90.00
Plate	4020-18	.[Finish]	-	\$73.00	\$260.00	\$298.00
Plate	4020-18G	.[Finish]	-	\$73.00	\$260.00	\$298.00
Fusible Link	4020-28	-	-	\$16.00	-	-

☛ Handed

4020 Series	Specify			Price		
	Part number	Finish	Handing	Powder coat	652 plated	Other plated
Cover Screw	4020-31	.[Finish]	-	\$7.00	-	-
☞ Hold Open Stud	4020-37	.[Finish]	.Handing	\$31.00	-	-
☞ FL Hold Open Stud	4020-37FL	.[Finish]	.Handing	\$31.00	-	-
Hold Open Nut	4020-41	.[Finish]	-	\$10.00	-	-
Hold Open Forearm	4020-48	.[Finish]	-	\$86.00	-	-
☞ Hold Open Main Arm	4020-49	.[Finish]	.Handing	\$81.00	-	-
FL Main Arm and Rod	4020-49FL	.[Finish]	-	\$81.00	-	-
Arm and Forearm	4020-77	.[Finish]	-	\$149.00	-	-
Rod and Shoe	4020-79	.[Finish]	-	\$37.00	\$93.00	\$130.00
H Rod and Shoe	4020-79H	.[Finish]	-	\$37.00	\$93.00	\$130.00
Long Rod and Shoe	4020-79LR	.[Finish]	-	\$37.00	\$93.00	\$130.00
Arm Screw	4020-83	.[Finish]	-	\$7.00	-	-
H Arm Screw	4020-83H	.[Finish]	-	\$7.00	-	-
Arm Screw	4020-159	.[Finish]	-	\$7.00	-	-
Flat Box w/Label	4020-Flat Box	-	-	\$9.00	-	-
Instruction Sheet	4020-Instruction Sheet	-	-	\$7.00	-	-
Box and Instruction Sheet	4020-Rebox Kit	-	-	\$9.00	-	-

4020T Series	Specify			Price		
	Part number	Finish	Handing	Powder coat	652 plated	Other plated
☞ Std Cylinder Assembly	4021(3,4)T-3071	.[Finish]	.Handing	\$433.00	-	-
☞ Standard Arm	4020T-3077T	.[Finish]	.Handing	\$144.00	\$414.00	\$451.00
Standard Track	4020T-3038	.[Finish]	-	\$93.00	-	-
Track w/Bumper	4020T-3038B	.[Finish]	-	\$98.00	-	-
Track w/Hold Open	4020T-3038H	.[Finish]	-	\$123.00	-	-
Track w/Hold Open and Bumper	4020T-3038HB	.[Finish]	-	\$135.00	-	-
☞ Standard Cover	4020T-72	.[Finish]	.Handing	\$31.00	-	-
☞ Metal Cover	4020T-72MC	.[Finish]	.Handing	\$50.00	\$267.00	\$328.00
Screw Pack (incl -3034)	4020T-SRT	.[Finish]	-	\$63.00	-	-
Screw Pack (incl -3034)	4020T-TBSRT	.[Finish]	-	\$63.00	-	-
Screw Pack (incl -3034)	4020T-WMS	.[Finish]	-	\$63.00	\$86.00	\$105.00
Screw Pack (incl -3034)	4020T-TBWMS	.[Finish]	-	\$63.00	\$86.00	\$105.00
Screw Pack (incl -3034)	4020T-TORX	.[Finish]	-	\$79.00	\$102.00	\$120.00
Screw Pack (incl -3034)	4020T-TBTRX	.[Finish]	-	\$79.00	\$102.00	\$120.00
HO Screw Pack (incl -3034H)	4020T-HSRT	.[Finish]	-	\$63.00	-	-
HO Screw Pack (incl -3034H)	4020T-HTBSRT	.[Finish]	-	\$63.00	-	-
HO Screw Pack (incl -3034H)	4020T-HWMS	.[Finish]	-	\$63.00	\$86.00	\$105.00
HO Screw Pack (incl -3034H)	4020T-HTBWMS	.[Finish]	-	\$63.00	\$86.00	\$105.00
HO Screw Pack (incl -3034H)	4020T-HTORX	.[Finish]	-	\$79.00	\$102.00	\$120.00
HO Screw Pack (incl -3034H)	4020T-HTBTRX	.[Finish]	-	\$79.00	\$102.00	\$120.00
Plate	4020T-18	.[Finish]	-	\$73.00	\$260.00	\$298.00
Cover Screw	4020T-31	.[Finish]	-	\$7.00	-	-
End Cap	4020T-73	-	-	\$14.00	-	-
Plug	4020T-141-2	.[Finish]	-	\$7.00	-	-

☞ Handed

PARTS AND ACCESSORIES

Powder coat

622	Matte Black (MTBLK)
689	Aluminum (AL)
690	Statuary Bronze (STAT)
691	Light Bronze (LTBRZ)
693	Black (GLBLK)
695	Dark Bronze (DKBRZ)
696	Brass (BRASS)

Plated

616	Satin Bronze, Blackened (US11)
632	Brass (US3)
633	Satin Brass (US4)
639	Satin Bronze (US10)
646	Satin Nickel (US15)
651	Bright Chrome (US26)
652	Satin Chrome (US26D)

Anodized

628	Aluminum (ANCLR)
710	Dark Bronze (ANDKB)

Handing

RH	Right hand
LH	Left hand

4020T Series	Specify			Price		
	Part number	Finish	Handing	Powder coat	652 plated	Other plated
Arm Screw	4020T-159	.[Finish]	-	\$7.00	-	-
Bumper Assembly	4020T-169	-	-	\$26.00	-	-
Roller Lock Screw	4020T-425	-	-	\$9.00	-	-
Track Roller	4020T-3034	-	-	\$37.00	-	-
Hold Open Track Roller	4020T-3034H	-	-	\$37.00	-	-
Hold Open Clip	4020T-3054	.[Finish]	-	\$37.00	-	-
HO Roller and Clip	4020T-3064H	-	-	\$73.00	-	-
Flat Box w/Label	4020T-Flat Box	-	-	\$9.00	-	-
Instruction Sheet	4020T-Instruction Sheet	-	-	\$7.00	-	-
Box and Instruction Sheet	4020T-Rebox Kit	-	-	\$9.00	-	-

4030 Series	Specify			Price		
	Part number	Finish	Handing	Powder coat	652 plated	Other plated
Std Cylinder Assembly	4031-3071	.[Finish]	-	\$370.00	-	-
Reg Arm	4030-3077	.[Finish]	-	\$149.00	\$422.00	\$459.00
Reg Arm w/62PA	4030-3077/PA	.[Finish]	-	\$149.00	\$422.00	\$459.00
Reg Arm w/62A	4030-3077/62A	.[Finish]	-	\$180.00	\$451.00	\$489.00
Light Duty Arm	4030-3077LD	.[Finish]	-	\$118.00	\$391.00	\$428.00
Light Duty Arm w/PA	4030-3077LD/PA	.[Finish]	-	\$135.00	\$408.00	\$445.00
Light Duty Arm w/62A	4030-3077LD/62A	.[Finish]	-	\$154.00	\$428.00	\$464.00
Long Arm	4030-3077L	.[Finish]	-	\$154.00	\$428.00	\$464.00
H Arm	4030-3049	.[Finish]	-	\$216.00	\$489.00	\$526.00
H Arm w/62PA	4030-3049/PA	.[Finish]	-	\$229.00	\$501.00	\$539.00
H Long Arm	4030-3049/L	.[Finish]	-	\$229.00	\$501.00	\$539.00
EDA Arm	4030-3077EDA	.[Finish]	-	\$198.00	\$470.00	\$508.00
✎ H EDA Arm	4030-3049EDA	.[Finish]	.[Handing]	\$247.00	\$521.00	\$557.00
Cush Arm	4030-3077CNS	.[Finish]	-	\$235.00	\$508.00	\$545.00
HCush Arm	4030-3049CNS	.[Finish]	-	\$321.00	\$594.00	\$631.00
SCush Arm	4030-3077SCNS	.[Finish]	-	\$328.00	\$599.00	\$638.00
Spring HCush Arm	4030-3049SCNS	.[Finish]	-	\$391.00	\$662.00	\$700.00
Metal Cover	4030-72MC	.[Finish]	-	\$50.00	\$267.00	\$328.00
Screw Pack	4030-WMS	.[Finish]	-	\$31.00	\$55.00	\$73.00
Screw Pack	4030-TBWMS	.[Finish]	-	\$31.00	\$55.00	\$73.00
Plate	4030-18PA	.[Finish]	-	\$73.00	\$260.00	\$298.00
Plate	4030-18TJ	.[Finish]	-	\$73.00	\$260.00	\$298.00
Cush Shoe Support	4030-30	.[Finish]	-	\$26.00	\$81.00	\$118.00
Cover Screw	4030-31	.[Finish]	-	\$7.00	-	-

✎ Handed

4030 Series	Specify			Price		
	Part number	Finish	Handing	Powder coat	652 plated	Other plated
Spacer	4030-61	.[Finish]	-	\$31.00	\$86.00	\$123.00
Auxiliary Shoe	4030-62A	.[Finish]	-	\$50.00	\$123.00	\$161.00
PA Shoe	4030-62PA	.[Finish]	-	\$19.00	\$112.00	\$149.00
Arm and Forearm	4030-77	.[Finish]	-	\$149.00	-	-
Rod and Shoe	4030-79	.[Finish]	-	\$37.00	\$93.00	\$130.00
Long Rod and Shoe	4030-79LR	.[Finish]	-	\$37.00	\$93.00	\$130.00
Arm Screw	4030-83	.[Finish]	-	\$7.00	-	-
H Arm Screw	4030-83H	.[Finish]	-	\$7.00	-	-
Arm Screw	4030-159	.[Finish]	-	\$7.00	-	-
Spacer	4030-201	-	-	\$9.00	-	-
Panel Adapter	4030-419	.[Finish]	-	\$81.00	\$186.00	\$224.00
Hold Open Shoe	4030-3045	.[Finish]	-	\$26.00	-	-
Head and Tube Assembly	4030-3048	.[Finish]	-	\$105.00	\$198.00	\$235.00
Spring Cush Block	4030-3080	.[Finish]	-	\$81.00	-	-
Flat Box w/Label	4030-Flat Box	-	-	\$9.00	-	-
Instruction Sheet	4030-Instruction Sheet	-	-	\$7.00	-	-
Box and Instruction Sheet	4030-Rebox Kit	-	-	\$9.00	-	-

4030T Series	Specify			Price		
	Part number	Finish	Handing	Powder coat	652 plated	Other plated
Std Cylinder Assembly	4031T-3071	.[Finish]	-	\$370.00	-	-
Standard Arm (includes 3034)	4030T-3077T	.[Finish]	-	\$144.00	\$414.00	\$451.00
Standard Track	4030T-3038	.[Finish]	-	\$93.00	-	-
Track w/Hold Open	4030T-3038H	.[Finish]	-	\$123.00	-	-
Metal Cover	4030T-72MC	.[Finish]	-	\$50.00	\$267.00	\$328.00
Screw Pack	4030T-WMS	.[Finish]	-	\$63.00	\$86.00	\$105.00
Screw Pack	4030T-TBWMS	.[Finish]	-	\$63.00	\$86.00	\$105.00
End Cup	4030T-73	-	-	\$14.00	-	-
Plug	4030T-141-1	.[Finish]	-	\$7.00	-	-
Plug	4030T-141-2	.[Finish]	-	\$7.00	-	-
Arm Screw	4030T-159	.[Finish]	-	\$7.00	-	-
Roller Lock Screw	4030T-425	-	-	\$9.00	-	-
Hold Open Clip	4030T-3054	-	-	\$37.00	-	-
Flat Box w/Label	4030T-Flat Box	-	-	\$9.00	-	-
Instruction Sheet	4030T-Instruction Sheet	-	-	\$7.00	-	-
Box and Instruction Sheet	4030T-Rebox Kit	-	-	\$9.00	-	-

4040XP Series	Specify			Price		
	Part number	Finish	Handing	Powder coat	652 plated	Other plated
Std Cylinder Assembly	4040XP-3071	.[Finish]	-	\$470.00	-	-
Delayed Action Cylinder Assembly	4040-3071DEL	.[Finish]	-	\$526.00	-	-
Reg Arm	4040XP-3077	.[Finish]	-	\$149.00	\$422.00	\$459.00
Reg Arm w/62PA	4040XP-3077/PA	.[Finish]	-	\$149.00	\$422.00	\$459.00

Handed

PARTS AND ACCESSORIES

Powder coat

622	Matte Black (MTBLK)
689	Aluminum (AL)
690	Statuary Bronze (STAT)
691	Light Bronze (LTBRZ)
693	Black (GLBLK)
695	Dark Bronze (DKBRZ)
696	Brass (BRASS)

Plated

616	Satin Bronze, Blackened (US11)
632	Brass (US3)
633	Satin Brass (US4)
639	Satin Bronze (US10)
646	Satin Nickel (US15)
651	Bright Chrome (US26)
652	Satin Chrome (US26D)

Anodized

628	Aluminum (ANCLR)
710	Dark Bronze (ANDKB)

Handing

RH	Right hand
LH	Left hand

4040XP Series	Specify			Price		
	Part number	Finish	Handing	Powder coat	652 plated	Other plated
Reg Arm w/62A	4040XP-3077/62A	.[Finish]	-	\$180.00	\$451.00	\$489.00
Long Arm	4040XP-3077L	.[Finish]	-	\$154.00	\$428.00	\$464.00
XL Reg Arm	4040XP-3077XL	.[Finish]	-	\$198.00	\$470.00	\$508.00
Hold Open Arm	4040XP-3049	.[Finish]	-	\$216.00	\$489.00	\$526.00
H Arm w/62PA	4040XP-3049/PA	.[Finish]	-	\$229.00	\$501.00	\$539.00
H Long Arm	4040XP-3049L	.[Finish]	-	\$229.00	\$501.00	\$539.00
EDA Arm	4040XP-3077EDA	.[Finish]	-	\$198.00	\$470.00	\$508.00
EDA Arm w/62G	4040XP-3077EDA/G	.[Finish]	-	\$204.00	\$476.00	\$514.00
☞ H EDA Arm	4040XP-3049EDA	.[Finish]	.[Handing]	\$247.00	\$521.00	\$557.00
☞ H EDA Arm w/62G	4040XP-3049EDA/G	.[Finish]	.[Handing]	\$260.00	\$531.00	\$568.00
Cush Arm	4040XP-3077CNS	.[Finish]	-	\$235.00	\$508.00	\$545.00
H Cush Arm	4040XP-3049CNS	.[Finish]	-	\$321.00	\$594.00	\$631.00
S Cush Arm	4040XP-3077SCNS	.[Finish]	-	\$328.00	\$599.00	\$638.00
Spring H Cush Arm	4040XP-3049SCNS	.[Finish]	-	\$391.00	\$662.00	\$700.00
Standard Cover	4040XP-72	.[Finish]	-	\$31.00	-	-
☞ Metal Cover	4040XP-72MC	.[Finish]	.[Handing]	\$50.00	\$267.00	\$328.00
Screw Pack	4040XP-SRT	.[Finish]	-	\$31.00	-	-
Screw Pack	4040XP-TBSRT	.[Finish]	-	\$31.00	-	-
Screw Pack	4040XP-WMS	.[Finish]	-	\$31.00	\$55.00	\$73.00
Screw Pack	4040XP-TBWMS	.[Finish]	-	\$31.00	\$55.00	\$73.00
Screw Pack	4040XP-TORX	.[Finish]	-	\$49.00	\$71.00	\$90.00
Screw Pack	4040XP-TBTRX	.[Finish]	-	\$49.00	\$71.00	\$90.00
Plate	4040XP-18	.[Finish]	-	\$73.00	\$260.00	\$298.00
Plate	4040XP-18G	.[Finish]	-	\$73.00	\$260.00	\$298.00
Plate	4040XP-18PA	.[Finish]	-	\$73.00	\$260.00	\$298.00
Plate	4040XP-18TJ	.[Finish]	-	\$73.00	\$260.00	\$298.00
Cush Shoe Support	4040XP-30	.[Finish]	-	\$26.00	\$81.00	\$118.00
Cover Screw	4040XP-31	.[Finish]	-	\$7.00	-	-
☞ Hold Open Stud	4040XP-37	.[Finish]	.[Handing]	\$31.00	-	-
☞ EDA Hold Open Stud	4040XP-37EDA	.[Finish]	.[Handing]	\$31.00	-	-
Hold Open Nut	4040XP-41	.[Finish]	-	\$10.00	-	-
Hold Open Shoe	4040XP-45	.[Finish]	-	\$26.00	-	-
Hold Open Forearm	4040XP-48	.[Finish]	-	\$86.00	-	-
Hold Open Main Arm	4040XP-49	.[Finish]	-	\$81.00	-	-
Snap-On Cover Clip Only	4040XP-54	.[Finish]	-	\$14.00	-	-
Spring and Screw (used with -80)	4040XP-58	-	-	\$16.00	-	-
Spacer	4040XP-61	.[Finish]	-	\$31.00	\$86.00	\$123.00

☞ Handed

4040XP Series	Specify			Price		
	Part number	Finish	Handing	Powder coat	652 plated	Other plated
Auxiliary Shoe	4040XP-62A	.[Finish]	-	\$50.00	\$123.00	\$161.00
PA Shoe	4040XP-62PA	.[Finish]	-	\$19.00	\$112.00	\$149.00
Arm and Forearm	4040XP-77	.[Finish]	-	\$149.00	-	-
H Head and Tube	4040XP-78H	.[Finish]	-	\$86.00	-	-
Head and Long Tube	4040XP-78HL	.[Finish]	-	\$93.00	-	-
Rod and Shoe	4040XP-79	.[Finish]	-	\$37.00	\$93.00	\$130.00
Long Rod and Shoe	4040XP-79LR	.[Finish]	-	\$37.00	\$93.00	\$130.00
XL Rod and Shoe	4040XP-79ELR	.[Finish]	-	\$81.00	\$186.00	\$224.00
Block (used with -58)	4040XP-80G	.[Finish]	-	\$63.00	-	-
Arm Screw	4040XP-83	.[Finish]	-	\$7.00	-	-
H Arm Screw	4040XP-83H	.[Finish]	-	\$7.00	-	-
Arm Stud	4040XP-95	.[Finish]	-	\$19.00	-	-
Metal Template	4040XP-107CUSH	-	-	\$328.00	-	-
Metal Template	4040XP-107EDA	-	-	\$328.00	-	-
Metal Template	4040XP-107REG	-	-	\$328.00	-	-
Metal Template	4040XP-107PA	-	-	\$328.00	-	-
Plug	4040XP-124	.[Finish]	-	\$7.00	-	-
Arm Screw	4040XP-159	.[Finish]	-	\$7.00	-	-
Spacer	4040XP-201	-	-	\$9.00	-	-
Stop	4040XP-384	.[Finish]	-	\$26.00	-	-
Panel Adapter	4040XP-419	.[Finish]	-	\$81.00	\$186.00	\$224.00
Head and Tube Assembly	4040XP-3048	.[Finish]	-	\$105.00	-	-
Head and Long Tube Assembly	4040XP-3048L	.[Finish]	-	\$105.00	-	-
Spring Cush Block Assembly (incl -58 and -80)	4040XP-3080	.[Finish]	-	\$81.00	-	-
Metal Template Set	4040XP-3107T	-	-	\$1,300.00	-	-
Flat Box w/Label	4040XP-Flat Box	-	-	\$9.00	-	-
Instruction Sheet	4040XP-Instruction Sheet	-	-	\$7.00	-	-
Box and Instruction Sheet	4040XP-Rebox Kit	-	-	\$9.00	-	-

4040XPT Series	Specify			Price		
	Part number	Finish	Handing	Powder coat	652 plated	Other plated
Std Cylinder Assembly	4040XPT-3071	.[Finish]	-	\$470.00	-	-
Standard Arm	4040XPT-3077T	.[Finish]	-	\$144.00	\$414.00	\$451.00
☞ DE Arm	4040XPT-3077DE	.[Finish]	.[Handing]	\$204.00	\$476.00	\$514.00
Standard Track	4040XPT-3038	.[Finish]	-	\$93.00	-	-
Track w/Bumper	4040XPT-3038B	.[Finish]	-	\$98.00	-	-
Track w/Hold Open	4040XPT-3038H	.[Finish]	-	\$123.00	-	-
Track w/Hold Open and Bumper	4040XPT-3038HB	.[Finish]	-	\$135.00	-	-
Standard Cover	4040XPT-72	.[Finish]	-	\$31.00	-	-
☞ Metal Cover	4040XPT-72MC	.[Finish]	.[Handing]	\$50.00	\$267.00	\$328.00
Screw Pack (incl -3034)	4040XPT-SRT	.[Finish]	-	\$63.00	-	-
Screw Pack (incl -3034)	4040XPT-TBSRT	.[Finish]	-	\$63.00	-	-
Screw Pack (incl -3034)	4040XPT-WMS	.[Finish]	-	\$63.00	\$86.00	\$105.00

☞ Handed

PARTS AND ACCESSORIES

Powder coat

622	Matte Black (MTBLK)
689	Aluminum (AL)
690	Statuary Bronze (STAT)
691	Light Bronze (LTBRZ)
693	Black (GLBLK)
695	Dark Bronze (DKBRZ)
696	Brass (BRASS)

Plated

616	Satin Bronze, Blackened (US11)
632	Brass (US3)
633	Satin Brass (US4)
639	Satin Bronze (US10)
646	Satin Nickel (US15)
651	Bright Chrome (US26)
652	Satin Chrome (US26D)

Anodized

628	Aluminum (ANCLR)
710	Dark Bronze (ANDKB)

Handing

RH	Right hand
LH	Left hand

4040XPT Series	Specify			Price		
	Part number	Finish	Handing	Powder coat	652 plated	Other plated
Screw Pack (incl -3034)	4040XPT-TBWMMS	.[Finish]	-	\$63.00	\$86.00	\$105.00
Screw Pack (incl -3034)	4040XPT-TORX	.[Finish]	-	\$79.00	\$102.00	\$120.00
Screw Pack (incl -3034)	4040XPT-TBTRX	.[Finish]	-	\$79.00	\$102.00	\$120.00
HO Screw Pack (incl -3034H)	4040XPT-HSRT	.[Finish]	-	\$63.00	-	-
HO Screw Pack (incl -3034H)	4040XPT-HTBSRT	.[Finish]	-	\$63.00	-	-
HO Screw Pack (incl -3034H)	4040XPT-HWMS	.[Finish]	-	\$63.00	\$86.00	\$105.00
HO Screw Pack (incl -3034H)	4040XPT-HTBWMS	.[Finish]	-	\$63.00	\$86.00	\$105.00
HO Screw Pack (incl -3034H)	4040XPT-HTORX	.[Finish]	-	\$79.00	\$102.00	\$120.00
HO Screw Pack (incl -3034H)	4040XPT-HTBTRX	.[Finish]	-	\$79.00	\$102.00	\$120.00
Plate	4040XPT-18	.[Finish]	-	\$73.00	\$260.00	\$298.00
Plate	4040XPT-18TJ	.[Finish]	-	\$73.00	\$260.00	\$298.00
Cover Screw	4040XPT-31	.[Finish]	-	\$7.00	-	-
Snap-On Cover Clip Only	4040XPT-54	.[Finish]	-	\$14.00	-	-
Spacer	4040XPT-61	.[Finish]	-	\$19.00	-	-
End Cap	4040XPT-73	-	-	\$14.00	-	-
⚡ Main Arm and Tube	4040XPT-78DE	.[Finish]	.[Handing]	\$98.00	-	-
Rod	4040XPT-82	.[Finish]	-	\$73.00	-	-
H Arm Set Screw	4040XPT-83H	.[Finish]	-	\$7.00	-	-
Plug	4040XPT-141-1	.[Finish]	-	\$7.00	-	-
Plug	4040XPT-141-2	.[Finish]	-	\$7.00	-	-
Arm Screw	4040XPT-159	.[Finish]	-	\$7.00	-	-
Bumper Assembly	4040XPT-169	-	-	\$26.00	-	-
Roller Lock Screw	4040XPT-425	-	-	\$9.00	-	-
Track Roller	4040XPT-3034	-	-	\$37.00	-	-
Hold Open Track Roller	4040XPT-3034H	-	-	\$37.00	-	-
Hold Open Clip	4040XPT-3054	-	-	\$37.00	-	-
Flat Box w/Label	4040XPT-Flat Box	-	-	\$9.00	-	-
Instruction Sheet	4040XPT-Instruction Sheet	-	-	\$7.00	-	-
Box and Instruction Sheet	4040XPT-Rebox Kit	-	-	\$9.00	-	-

4050A Series	Specify			Price
	Part number	Finish	Handing	Powder coat
Std Cylinder Assembly	4050A-3071	.[Finish]	-	\$364.00
Delayed Action Cylinder Assembly	4050A-3071DEL	.[Finish]	-	\$419.00
Reg Arm w/62PA	4050A-3077/PA	.[Finish]	-	\$146.00
Reg Arm w/62A	4050A-3077/62A	.[Finish]	-	\$176.00
Long Arm	4050A-3077L	.[Finish]	-	\$152.00

⚡ Handed

4050A Series	Specify			Price
	Part number	Finish	Handing	Powder coat
H Arm w/62PA	4050A-3049/PA	.[Finish]	-	\$226.00
H Long Arm	4050A-3049L	.[Finish]	-	\$226.00
EDA Arm	4050A-3077EDA	.[Finish]	-	\$194.00
EDA Arm w/62G	4050A-3077EDA/G	.[Finish]	-	\$200.00
 H EDA Arm	4050A-3049EDA	.[Finish]	.[Handing]	\$243.00
 H EDA Arm w/62G	4050A-3049EDA/G	.[Finish]	.[Handing]	\$254.00
Cush Arm	4050A-3077CNS	.[Finish]	-	\$231.00
H Cush Arm	4050A-3049CNS	.[Finish]	-	\$315.00
S Cush Arm	4050A-3077SCNS	.[Finish]	-	\$321.00
Spring H Cush Arm	4050A-3049SCNS	.[Finish]	-	\$382.00
Cover Screw	4050A-31	-	-	\$7.00
Standard Cover	4050A-72	.[Finish]	-	\$31.00
Alternative cover	4050A-72ALT	.[Finish]	-	\$37.00
Metal Cover	4050A-72MC	.[Finish]	-	\$49.00
Screw Pack	4050A-SRT	.[Finish]	-	\$31.00
Screw Pack	4050A-TBSRT	.[Finish]	-	\$31.00
Screw Pack	4050A-WMS	.[Finish]	-	\$31.00
Screw Pack	4050A-TBWMS	.[Finish]	-	\$31.00
Screw Pack	4050A-TORX	.[Finish]	-	\$48.00
Screw Pack	4050A-TBTRX	.[Finish]	-	\$48.00
Plate	4050A-18	.[Finish]	-	\$72.00
Plate	4050A-18G	.[Finish]	-	\$72.00
Plate	4050A-18PA	.[Finish]	-	\$72.00
Cush Shoe Support	4050A-30	.[Finish]	-	\$26.00
Spacer	4050A-61	.[Finish]	-	\$31.00
Auxiliary Shoe	4050A-62A	.[Finish]	-	\$49.00
PA Shoe	4050A-62PA	.[Finish]	-	\$19.00
PA shoe for Delay	4050A-62DAPA	.[Finish]	-	\$19.00
Panel Adapter	4050A-419	.[Finish]	-	\$79.00
Spring Cush Block Assembly (incl -58 and -80)	4050A-3080	.[Finish]	-	\$79.00
Flat Box w/Label	4050A-Flat Box	-	-	\$9.00
Instruction Sheet	4050A-Instruction Sheet	-	-	\$7.00
Box and Instruction Sheet	4050A-Rebox Kit	-	-	\$9.00

4050AT Series	Specify			Price
	Part number	Finish	Handing	Powder coat
Std Cylinder Assembly	4050AT-3071	.[Finish]	-	\$364.00
Standard Arm	4050AT-3077T	.[Finish]	-	\$139.00
 DE Arm	4050AT-3077DE	.[Finish]	.[Handing]	\$183.00
Standard Track	4050AT-3038	.[Finish]	-	\$92.00
Track w/Bumper	4050AT-3038B	.[Finish]	-	\$97.00
Track w/Hold Open	4050AT-3038H	.[Finish]	-	\$121.00
Track w/Hold Open and Bumper	4050AT-3038HB	.[Finish]	-	\$133.00

 Handed

PARTS AND ACCESSORIES

Powder coat

622	Matte Black (MTBLK)
689	Aluminum (AL)
690	Statuary Bronze (STAT)
691	Light Bronze (LTBRZ)
693	Black (GLBLK)
695	Dark Bronze (DKBRZ)
696	Brass (BRASS)

Plated

616	Satin Bronze, Blackened (US11)
632	Brass (US3)
633	Satin Brass (US4)
639	Satin Bronze (US10)
646	Satin Nickel (US15)
651	Bright Chrome (US26)
652	Satin Chrome (US26D)

Anodized

628	Aluminum (ANCLR)
710	Dark Bronze (ANDKB)

Handing

RH	Right hand
LH	Left hand

4050AT Series	Specify			Price
	Part number	Finish	Handing	Powder coat
Standard Cover	4050AT-72	.[Finish]	-	\$31.00
Metal Cover	4050AT-72MC	.[Finish]	-	\$49.00
Screw Pack (incl -3034)	4050AT-SRT	.[Finish]	-	\$62.00
Screw Pack (incl -3034)	4050AT-TBSRT	.[Finish]	-	\$62.00
Screw Pack (incl -3034)	4050AT-WMS	.[Finish]	-	\$62.00
Screw Pack (incl -3034)	4050AT-TBWMS	.[Finish]	-	\$62.00
Screw Pack (incl -3034)	4050AT-TORX	.[Finish]	-	\$77.00
Screw Pack (incl -3034)	4050AT-TBTRX	.[Finish]	-	\$77.00
HO Screw Pack (incl -3034H)	4050AT-HSRT	.[Finish]	-	\$62.00
HO Screw Pack (incl -3034H)	4050AT-HTBSRT	.[Finish]	-	\$62.00
HO Screw Pack (incl -3034H)	4050AT-HWMS	.[Finish]	-	\$62.00
HO Screw Pack (incl -3034H)	4050AT-HTBWMS	.[Finish]	-	\$62.00
HO Screw Pack (incl -3034H)	4050AT-HTORX	.[Finish]	-	\$77.00
HO Screw Pack (incl -3034H)	4050AT-HTBTRX	.[Finish]	-	\$77.00
Plate	4050AT-18	.[Finish]	-	\$72.00
Plate	4050AT-18G	.[Finish]	-	\$72.00
Cover Screw	4050AT-31	.[Finish]	-	\$7.00
End Cap	4050AT-73	-	-	\$14.00
☞ Main Arm and Tube	4050AT-78DE	.[Finish]	.[Handing]	\$97.00
Rod	4050AT-82	.[Finish]	-	\$72.00
H Arm Set Screw	4050AT-83H	.[Finish]	-	\$7.00
Plug	4050AT-141-1	.[Finish]	-	\$7.00
Plug	4050AT-141-2	.[Finish]	-	\$7.00
Arm Screw	4050AT-159	.[Finish]	-	\$7.00
Bumper Assembly	4050AT-169	-	-	\$26.00
Roller Lock Screw	4050AT-425	-	-	\$9.00
Shaft Extender	4050AT-480	-	-	\$67.00
Track Roller	4050AT-3034	-	-	\$37.00
Hold Open Track Roller	4050AT-3034H	-	-	\$37.00
Hold Open Clip	4050AT-3054	-	-	\$37.00
Flat Box w/Label	4050AT-Flat Box	-	-	\$9.00
Instruction Sheet	4050AT-Instruction Sheet	-	-	\$7.00
Box and Instruction Sheet	4050AT-Rebox Kit	-	-	\$9.00

☞ Handed

4110 Series	Specify			Price		
	Part number	Finish	Handing	Powder coat	652 plated	Other plated
☞ Std Cylinder Assembly	4111(6)-3071	.[Finish]	.[Handing]	\$402.00	-	-
☞ AVB Cylinder Assembly	4111(6)-3071AVB	.[Finish]	.[Handing]	\$433.00	-	-
☞ Delayed Action Cylinder Assembly	4111-3071DEL	.[Finish]	.[Handing]	\$458.00	-	-
☞ TEL Cylinder Assembly	4111(6)-3071TEL	.[Finish]	.[Handing]	\$458.00	-	-
Reg Arm w/62A	4110-3077/62A	.[Finish]	-	\$180.00	\$451.00	\$489.00
EDA Arm	4110-3077EDA	.[Finish]	-	\$198.00	\$470.00	\$508.00
EDA Arm w/62G	4110-3077EDA/G	.[Finish]	-	\$204.00	\$476.00	\$514.00
☞ H EDA Arm	4110-3049EDA	.[Finish]	.[Handing]	\$247.00	\$521.00	\$557.00
☞ H EDA Arm w/62G	4110-3049EDA/G	.[Finish]	.[Handing]	\$260.00	\$531.00	\$568.00
Cush Arm	4110-3077CNS	.[Finish]	-	\$235.00	\$508.00	\$545.00
H Cush Arm	4110-3049CNS	.[Finish]	-	\$321.00	\$594.00	\$631.00
S Cush Arm	4110-3077SCNS	.[Finish]	-	\$328.00	\$599.00	\$638.00
Spring H Cush Arm	4110-3049SCNS	.[Finish]	-	\$391.00	\$662.00	\$700.00
☞ FL Arm	4110-3049FL	.[Finish]	.[Handing]	\$334.00	-	-
Standard Cover	4110-72	.[Finish]	-	\$31.00	-	-
☞ Metal Cover	4110-72MC	.[Finish]	.[Handing]	\$50.00	\$267.00	\$328.00
Screw Pack	4110-SRT	.[Finish]	-	\$31.00	-	-
Screw Pack	4110-TBSRT	.[Finish]	-	\$31.00	-	-
Screw Pack	4110-WMS	.[Finish]	-	\$31.00	\$55.00	\$73.00
Screw Pack	4110-TBWMS	.[Finish]	-	\$31.00	\$55.00	\$73.00
Screw Pack	4110-TORX	.[Finish]	-	\$49.00	\$71.00	\$90.00
Screw Pack	4110-TBTRX	.[Finish]	-	\$49.00	\$71.00	\$90.00
Plate	4110-18	.[Finish]	-	\$73.00	\$260.00	\$298.00
Fusible Link	4110-28	-	-	\$16.00	-	-
Cush Shoe Support	4110-30	.[Finish]	-	\$26.00	\$81.00	\$118.00
Cover Screw	4110-31	.[Finish]	-	\$7.00	-	-
☞ Hold Open Stud	4110-37	.[Finish]	.[Handing]	\$31.00	-	-
Hold Open Nut	4110-41	.[Finish]	-	\$10.00	-	-
Hold Open Forearm	4110-48	.[Finish]	-	\$86.00	-	-
FL Main Arm and Rod	4110-49FL	.[Finish]	-	\$81.00	-	-
Spring and Screw (used with -80)	4110-58	-	-	\$16.00	-	-
Spacer	4110-61	.[Finish]	-	\$31.00	\$86.00	\$123.00
PA-FL Shoe	4110-62FL	.[Finish]	-	\$19.00	-	-
Main Arm	4110-77EDA	.[Finish]	-	\$149.00	-	-
Block (used with -58)	4110-80G	.[Finish]	-	\$63.00	-	-
Metal Template	4110-107 EDA	-	-	\$328.00	-	-
Metal Template	4110-107 CUSH	-	-	\$328.00	-	-
Metal Template	4110-3107T	-	-	\$657.00	-	-
Arm Screw	4110-159	.[Finish]	-	\$7.00	-	-
Spacer	4110-201	-	-	\$9.00	-	-
Spring Cush Block (incl -58 and -80)	4110-3080	-	-	\$81.00	-	-
Panel Adapter	4110-419	.[Finish]	-	\$81.00	\$186.00	\$224.00
Flat Box w/Label	4110-Flat Box	-	-	\$9.00	-	-
Instruction Sheet	4110-Instruction Sheet	-	-	\$7.00	-	-
Box and Instruction Sheet	4110-Rebox Kit	-	-	\$9.00	-	-

☞ Handed

PARTS AND ACCESSORIES

Powder coat

622	Matte Black (MTBLK)
689	Aluminum (AL)
690	Statuary Bronze (STAT)
691	Light Bronze (LTBRZ)
693	Black (GLBLK)
695	Dark Bronze (DKBRZ)
696	Brass (BRASS)

Plated

616	Satin Bronze, Blackened (US11)
632	Brass (US3)
633	Satin Brass (US4)
639	Satin Bronze (US10)
646	Satin Nickel (US15)
651	Bright Chrome (US26)
652	Satin Chrome (US26D)

Anodized

628	Aluminum (ANCLR)
710	Dark Bronze (ANDKB)

Handing

RH	Right hand
LH	Left hand

4110T Series	Specify			Price		
	Part number	Finish	Handing	Powder coat	652 plated	Other plated
Std Cylinder Assembly	4111(3,4)T-3071	.[Finish]	.[Handing]	\$402.00	-	-
Standard Arm	4110T-3077T	.[Finish]	.[Handing]	\$144.00	\$414.00	\$451.00
Standard Track	4110T-3038	.[Finish]	-	\$93.00	-	-
Track w/Bumper	4110T-3038B	.[Finish]	-	\$98.00	-	-
Track w/Hold Open	4110T-3038H	.[Finish]	-	\$123.00	-	-
Track w/Hold Open and Bumper	4110T-3038HB	.[Finish]	-	\$135.00	-	-
Standard Cover	4110T-72	.[Finish]	-	\$31.00	-	-
Metal Cover	4110T-72MC	.[Finish]	.[Handing]	\$50.00	\$267.00	\$328.00
Screw Pack (incl -3034)	4110T-SRT	.[Finish]	-	\$63.00	-	-
Screw Pack (incl -3034)	4110T-TBSRT	.[Finish]	-	\$63.00	-	-
Screw Pack (incl -3034)	4110T-WMS	.[Finish]	-	\$63.00	\$86.00	\$105.00
Screw Pack (incl -3034)	4110T-TBWMS	.[Finish]	-	\$63.00	\$86.00	\$105.00
Screw Pack (incl -3034)	4110T-TORX	.[Finish]	-	\$79.00	\$102.00	\$120.00
Screw Pack (incl -3034)	4110T-TBTRX	.[Finish]	-	\$79.00	\$102.00	\$120.00
HO Screw Pack (incl -3034H)	4110T-HSRT	.[Finish]	-	\$63.00	-	-
HO Screw Pack (incl -3034H)	4110T-HTBSRT	.[Finish]	-	\$63.00	-	-
HO Screw Pack (incl -3034H)	4110T-HWMS	.[Finish]	-	\$63.00	\$86.00	\$105.00
HO Screw Pack (incl -3034H)	4110T-HTBWMS	.[Finish]	-	\$63.00	\$86.00	\$105.00
HO Screw Pack (incl -3034H)	4110T-HTORX	.[Finish]	-	\$79.00	\$102.00	\$120.00
HO Screw Pack (incl -3034H)	4110T-HTBTRX	.[Finish]	-	\$79.00	\$102.00	\$120.00
Plate	4110T-18	.[Finish]	-	\$73.00	\$260.00	\$298.00
Cover Screw	4110T-31	.[Finish]	-	\$7.00	-	-
End Cap	4110T-73	-	-	\$14.00	-	-
Plug	4110T-141-1	.[Finish]	-	\$7.00	-	-
Arm Screw	4110T-159	.[Finish]	-	\$7.00	-	-
Bumper Assembly	4110T-169	-	-	\$26.00	-	-
Roller Lock Screw	4110T-425	-	-	\$9.00	-	-
Track Roller	4110T-3034	-	-	\$37.00	-	-
Hold Open Track Roller	4110T-3034H	-	-	\$37.00	-	-
Hold Open Clip	4110T-3054	.[Finish]	-	\$37.00	-	-
HO Roller and Clip	4110T-3064H	-	-	\$73.00	-	-
Flat Box w/Label	4110T-Flat Box	-	-	\$9.00	-	-
Instruction Sheet	4110T-Instruction Sheet	-	-	\$7.00	-	-
Box and Instruction Sheet	4110T-Rebox Kit	-	-	\$9.00	-	-

Handed

this page intentionally blank

2010 SERIES

The concealed 2010 Series is a heavy duty closer designed to provide complete concealment. The single lever arm and roller assembly provide smooth, quiet door control and the choice of finishes and track functions meet virtually all architectural requirements.

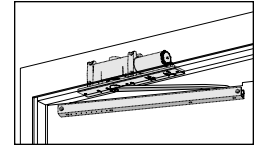

622	689	690	691	693	695	696	652	616	632	633	639	646	651
MTBLK	AL	STAT	LTBRZ	GLBLK	DKBRZ	BRASS	US26D	US11	US3	US4	US10	US15	US26

ACN for these commonly ordered products	PRICE BASED ON FINISH			
	POWDER COAT		PLATED	
	622	689	616	632
690	691	633	639	
693	695	652	646	
696			651	

DEFAULT CONFIGURATIONS						
Model	Track	Finish	Handing			
[2011, 2013, 2014, 2015, or 2016]	STDTRK	[Finish]	[RH, LH]	\$841.00	\$1,474.00	\$1,660.00
[2011, 2013, 2014, 2015, or 2016]	H	[Finish]	[RH, LH]	\$871.00	\$1,504.00	\$1,690.00
[2011, 2013, 2014, 2015, or 2016]	BUMP	[Finish]	[RH, LH]	\$846.00	\$1,479.00	\$1,665.00
[2011, 2013, 2014, 2015, or 2016]	HBUMP	[Finish]	[RH, LH]	\$883.00	\$1,516.00	\$1,702.00

DEFAULT AND COMMON CONFIGURATIONS

Pricing includes default options shown below unless otherwise specified. Specification rules, additional options and pricing adders are shown in the tables below.

Cylinder

Cast iron Cylinder Assembly with Mounting Plate (CYL)

Arm type

Standard Arm (STDTRKARM)

Screw package

STDTRK and BUMP tracks: Wood and Machine Screws (WMS);

H and HBMP tracks: Hold Open Wood and Machine Screws (HWMS)

BAA Compliant

See the [Allegion Buy America/ Buy American and Trade Agreement Acts \(BAA and TAA\) Compliance Guide](#) for full details

SPECIFICATION RULES, ADDITIONAL OPTIONS AND PRICING ADDERS

Order of attributes when placing an order for a non-standard configuration. See parts section for individual parts pricing. Attributes show in CAPS are required. Other attributes are required only if you are deviating from the product's default.

MODEL . TRACK TYPE . FINISH . Special rust inhibitor . HANDING . Screw package

Custom powder coat finishes	Specify	Price adder
Apply price adder to powder coat price		
Custom Power Coat Finish	RAL []	\$50.00
Brite Metallic Powder Coat	MTLPC	\$73.00
Special rust inhibiting primer	Specify	Price adder
Special Rust Inhibitor for Powder Coat Finishes	SRI	\$50.00
Screw package	Specify	Price adder
Wood and Machine Screws (WMS) - Default	-	-
Hold Open Wood and Machine Screws (HWMS) - Default	-	-
Torx Machine Screws	TORX	\$16.00
Hold Open Torx Screws	HTORX	\$16.00

☞ Handing required

2030 SERIES

The concealed 2030 Series PACER® is a heavy duty closer designed to fit in a narrow, minimum 1-3/4" aluminum transom. The single lever arm and roller assembly provide smooth, quiet door control and the choice of finishes and track functions meet virtually all architectural requirements.

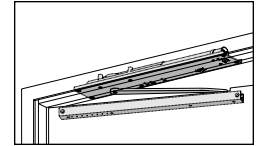

622	689	690	691	693	695	696	652	616	632	633	639	646	651
MTBLK	AL	STAT	LTBRZ	GLBLK	DKBRZ	BRASS	US26D	US11	US3	US4	US10	US15	US26

ACN for these commonly ordered products	PRICE BASED ON FINISH					
	POWDER COAT			PLATED		
	622	689		616	632	
690	691		633	639		
693	695	652	646	651		
696						

DEFAULT CONFIGURATIONS						
Model	Track	Finish	Handing			
[2031, 2032, 2033, 2034 or 2035]	STDTRK	[Finish]	[RH, LH]	\$1,399.00	\$2,031.00	\$2,217.00
[2031, 2032, 2033, 2034 or 2035]	H	[Finish]	[RH, LH]	\$1,429.00	\$2,061.00	\$2,247.00
[2031, 2032, 2033, 2034 or 2035]	BUMP	[Finish]	[RH, LH]	\$1,404.00	\$2,036.00	\$2,222.00
[2031, 2032, 2033, 2034 or 2035]	HBUMP	[Finish]	[RH, LH]	\$1,441.00	\$2,073.00	\$2,259.00

DEFAULT AND COMMON CONFIGURATIONS

Pricing includes default options shown below unless otherwise specified. Specification rules, additional options and pricing adders are shown in the tables below.

Cylinder

Cast iron Cylinder Assembly with Mounting Plate (CYL)

Arm type

Standard Arm (STDTRKARM)

Screw package

STDTRK and BUMP tracks: Wood and Machine Screws (WMS);

H and HBMP tracks: Hold Open Wood and Machine Screws (HWMS)

BAA Compliant

See the [Allegion Buy America/ Buy American and Trade Agreement Acts \(BAA and TAA\) Compliance Guide](#) for full details

SPECIFICATION RULES, ADDITIONAL OPTIONS AND PRICING ADDERS

Order of attributes when placing an order for a non-standard configuration. See parts section for individual parts pricing. Attributes show in CAPS are required. Other attributes are required only if you are deviating from the product's default.

MODEL . TRACK TYPE . FINISH . Special rust inhibitor . HANDING . Screw package

Custom powder coat finishes	Specify	Price adder
Apply price adder to powder coat price		
Custom Power Coat Finish	RAL []	\$50.00
Brite Metallic Powder Coat	MTLPC	\$73.00
Special rust inhibiting primer	Specify	Price adder
Special Rust Inhibitor for Powder Coat Finishes	SRI	\$50.00
Screw package	Specify	Price adder
Wood and Machine Screws (WMS) - Default	-	-
Hold Open Wood and Machine Screws (HWMS) - Default	-	-
Torx Machine Screws	TORX	\$16.00
Hold Open Torx Screws	HTORX	\$16.00

☞ Handing required

3030 SERIES

The concealed 3030 Series is designed to mount in a 1-3/4" interior door. The double lever arm provides superior door control and the choice of finishes and arm functions meet virtually all architectural requirements.

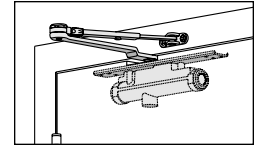

622	689	690	691	693	695	696	652	616	632	633	639	646	651
MTBLK	AL	STAT	LTBRZ	GLBLK	DKBRZ	BRASS	US26D	US11	US3	US4	US10	US15	US26

ACN for these commonly ordered products	PRICE BASED ON FINISH				
	POWDER COAT		PLATED		
	622	689	652	616	632
	690	691		633	639
	693	695		646	651
	696				

DEFAULT CONFIGURATIONS					
Model	Arm	Finish	Handing		
[3031, 3032, 3033 or 3034]	REGARM	[Finish]	[RH, LH]	\$582.00	\$855.00
[3031, 3032, 3033 or 3034]	H	[Finish]	[RH, LH]	\$582.00	\$892.00

DEFAULT AND COMMON CONFIGURATIONS

Pricing includes default options shown below unless otherwise specified. Specification rules, additional options and pricing adders are shown in the tables below.

Cylinder

Cast iron Cylinder Assembly with Mounting Plate (CYL)

Screw package

Wood and Machine Screws (WMS)

BAA Compliant

See the [Allegion Buy America/ Buy American and Trade Agreement Acts \(BAA and TAA\) Compliance Guide](#) for full details

SPECIFICATION RULES, ADDITIONAL OPTIONS AND PRICING ADDERS

Order of attributes when placing an order for a non-standard configuration. See parts section for individual parts pricing. Attributes show in CAPS are required. Other attributes are required only if you are deviating from the product's default.

MODE . ARM TYPE . FINISH . Special rust inhibitor . HANDING . Screw package

Custom powder coat finishes	Specify	Price adder
Apply price adder to powder coat price		
Custom Power Coat Finish	RAL []	\$50.00
Brite Metallic Powder Coat	MTLPC	\$73.00
Special rust inhibiting primer	Specify	Price adder
Special Rust Inhibitor for Powder Coat Finishes	SRI	\$50.00
Screw package	Specify	Price adder
Wood and Machine Screws (WMS) - Default	-	-
Torx Machine Screws	TORX	\$16.00

Handing required

3130 SERIES

The concealed 3130 Series is designed to mount in a 1-3/4" interior door. The single lever arm and roller assembly provides complete concealment and the choice of finishes and track functions meet virtually all architectural requirements.

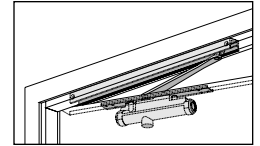

622	689	690	691	693	695	696	652	616	632	633	639	646	651
MTBLK	AL	STAT	LTBRZ	GLBLK	DKBRZ	BRASS	US26D	US11	US3	US4	US10	US15	US26

ACN for these commonly ordered products				PRICE BASED ON FINISH				
				POWDER COAT		PLATED		
				622	689		616	632
				690	691	652	633	639
				693	695		646	651
				696				
DEFAULT CONFIGURATIONS								
Model	Track	Finish						
☞ [3131, 3132, or 3133]	STDTRACK	[Finish]		\$706.00	\$979.00	\$1,016.00		
☞ [3131, 3132, or 3133]	H	[Finish]		\$736.00	\$1,009.00	\$1,046.00		
☞ [3131, 3132, or 3133]	BUMP	[Finish]		\$711.00	\$984.00	\$1,021.00		
☞ [3131, 3132, or 3133]	HBUMP	[Finish]		\$748.00	\$1,021.00	\$1,058.00		

DEFAULT AND COMMON CONFIGURATIONS

Pricing includes default options shown below unless otherwise specified. Specification rules, additional options and pricing adders are shown in the tables below.

Cylinder

Cast iron Cylinder Assembly with Mounting Plate (CYL)

Arm type

Standard Arm (STDTRKARM)

Screw package

STDTRK and BUMP tracks: Wood and Machine Screws (WMS);

H and HBMP tracks: Hold Open Wood and Machine Screws (HWMS)

BAA Compliant

See the [Allegion Buy America/ Buy American and Trade Agreement Acts \(BAA and TAA\) Compliance Guide](#) for full details

SPECIFICATION RULES, ADDITIONAL OPTIONS AND PRICING ADDERS

Order of attributes when placing an order for a non-standard configuration. See parts section for individual parts pricing. Attributes show in CAPS are required. Other attributes are required only if you are deviating from the product's default.

MODEL . TRACK TYPE . FINISH . Special rust inhibitor . HANDING . Screw package

Custom powder coat finishes	Specify	Price adder
Apply price adder to powder coat price		
Custom Power Coat Finish	RAL []	\$50.00
Brite Metallic Powder Coat	MTLPC	\$73.00
Special rust inhibiting primer	Specify	Price adder
Special Rust Inhibitor for Powder Coat Finishes	SRI	\$50.00
Screw package	Specify	Price adder
Wood and Machine Screws (WMS) - Default	-	-
Hold Open Wood and Machine Screws (HWMS) - Default	-	-
Torx Machine Screws	TORX	\$16.00
Hold Open Torx Screws	HTORX	\$16.00

☞ Handing required

5010 SERIES

The concealed 5010 Series is a heavy duty closer designed for institutional, high traffic, or other applications exposed to weather or abuse. The double lever arm provides superior door control and a choice of finishes, cylinder functions, and arm functions that meet virtually all architectural requirements.

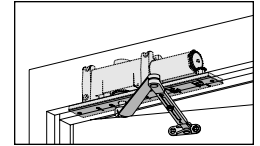

622	689	690	691	693	695	696	652	616	632	633	639	646	651
MTBLK	AL	STAT	LTBRZ	GLBLK	DKBRZ	BRASS	US26D	US11	US3	US4	US10	US15	US26

ACN for these commonly ordered products	PRICE BASED ON FINISH					
	POWDER COAT			PLATED		
	622	689		616	632	
	690	691	652	633	639	
693	695		646	651		
696						

DEFAULT CONFIGURATIONS						
Model	Arm	Finish	Handing			
[5011, 5012, 5013, 5014, 5015, 5016]	REGARM	[Finish]	[RH, LH]	\$780.00	\$1,412.00	\$1,598.00
[5011, 5012, 5013, 5014, 5015, 5016]	H	[Finish]	[RH, LH]	\$780.00	\$1,412.00	\$1,598.00

DEFAULT AND COMMON CONFIGURATIONS

Pricing includes default options shown below unless otherwise specified. Specification rules, additional options and pricing adders are shown in the tables below.

Cylinder

Cast iron Cylinder Assembly with Mounting Plate (CYL)

Screw package

Wood and Machine Screws (WMS)

BAA Compliant

See the [Allegion Buy America/ Buy American and Trade Agreement Acts \(BAA and TAA\) Compliance Guide](#) for full details

SPECIFICATION RULES, ADDITIONAL OPTIONS AND PRICING ADDERS

Order of attributes when placing an order for a non-standard configuration. See parts section for individual parts pricing. Attributes show in CAPS are required. Other attributes are required only if you are deviating from the product's default.

MODEL . Cylinder . ARM TYPE . FINISH . Special rust inhibitor . HANDING . Screw package

Cylinder	Specify	Price adder
Cast iron Cylinder Assembly with Mounting Plate (CYL) - Default	-	-
Delay Action Cylinder	CYLDEL	\$55.00
Custom powder coat finishes Apply price adder to powder coat price	Specify	Price adder
Custom Powder Coat Finish	RAL []	\$50.00
Brite Metallic Powder Coat	MTLPC	\$73.00
Special rust inhibiting primer	Specify	Price adder
Special Rust Inhibitor for Powder Coat Finishes	SRI	\$50.00
Screw package	Specify	Price adder
Wood and Machine Screws (WMS) - Default	-	-
Torx Machine Screws	TORX	\$16.00

☞ Handing required

5030 SERIES

The concealed 5030 Series PACER® is a heavy duty closer designed to fit in a narrow, minimum 1-3/4" aluminum transom. The double lever arm provides superior door control and the choice of finishes and arm functions meet virtually all architectural requirements.

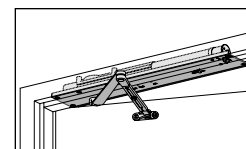

622	689	690	691	693	695	696	652	616	632	633	639	646	651
MTBLK	AL	STAT	LTBRZ	GLBLK	DKBRZ	BRASS	US26D	US11	US3	US4	US10	US15	US26

ACN for these commonly ordered products	PRICE BASED ON FINISH		
	POWDER COAT	PLATED	
	622 689		616 632
	690 691	652	633 639
	693 695		646 651
	696		
DEFAULT CONFIGURATIONS			
Model	Arm	Finish	Handing
[5031, 5033, 5034, 5035 or 5036]	REGARM	[Finish]	[RH, LH]
[5031, 5033, 5034, 5035 or 5036]	H	[Finish]	[RH, LH]

DEFAULT AND COMMON CONFIGURATIONS

Pricing includes default options shown below unless otherwise specified. Specification rules, additional options and pricing adders are shown in the tables below.

Cylinder

Cast iron Cylinder Assembly with Mounting Plate (CYL)

Screw package

Wood and Machine Screws (WMS)

BAA Compliant

See the [Allegion Buy America/ Buy American and Trade Agreement Acts \(BAA and TAA\) Compliance Guide](#) for full details

SPECIFICATION RULES, ADDITIONAL OPTIONS AND PRICING ADDERS

Order of attributes when placing an order for a non-standard configuration. See parts section for individual parts pricing. Attributes show in CAPS are required. Other attributes are required only if you are deviating from the product's default.

MODEL . ARM TYPE . FINISH . Special rust inhibitor . HANDING . Screw package

Custom powder coat finishes	Specify	Price adder
Apply price adder to powder coat price		
Custom Power Coat Finish	RAL []	\$50.00
Brite Metallic Powder Coat	MTLPC	\$73.00
Special rust inhibiting primer	Specify	Price adder
Special Rust Inhibitor for Powder Coat Finishes	SRI	\$50.00
Screw package	Specify	Price adder
Wood and Machine Screws (WMS) - Default	-	-
Torx Machine Screws	TORX	\$16.00

☞ Handing required

6030 SERIES

The concealed 6030 Series PACER® is a heavy duty, double acting closer designed to fit in a narrow, minimum 1-3/4" header. The single lever arm and roller assembly provides smooth, quiet door control and the choice of finishes and track functions meet virtually all architectural requirements. Installation at left illustrated with center pivot set (not included).

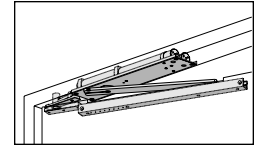

622	689	690	691	693	695	696	652	616	632	633	639	646	651
MTBLK	AL	STAT	LTBRZ	GLBLK	DKBRZ	BRASS	US26D	US11	US3	US4	US10	US15	US26

ACN for these commonly ordered products	PRICE BASED ON FINISH			
	POWDER COAT		PLATED	
	622	689	616	632
690	691	633	639	
693	695	652	646	
696			651	

DEFAULT CONFIGURATIONS				
Model	Track	Finish		
[6031, 6032, 6033, 6034, 6035]	BUMP	[Finish]	\$1,682.00	\$2,315.00
[6031, 6032, 6033, 6034, 6035]	HBUMP	[Finish]	\$1,719.00	\$2,352.00

DEFAULT AND COMMON CONFIGURATIONS

Pricing includes default options shown below unless otherwise specified. Specification rules, additional options and pricing adders are shown in the tables below.

Cylinder

Cast iron Cylinder Assembly with Mounting Plate (CYL)

Arm type

Standard Arm (STDTRKARM)

Screw package

BUMP track: Wood and Machine Screws (WMS);

HBMP track: Hold Open Wood and Machine Screws (HWMS)

BAA Compliant

See the [Allegion Buy America/ Buy American and Trade Agreement Acts \(BAA and TAA\) Compliance Guide](#) for full details

SPECIFICATION RULES, ADDITIONAL OPTIONS AND PRICING ADDERS

Order of attributes when placing an order for a non-standard configuration. See parts section for individual parts pricing. Attributes show in CAPS are required. Other attributes are required only if you are deviating from the product's default.

MODEL . TRACK TYPE . FINISH . Special rust inhibitor . Screw package

Custom powder coat finishes	Specify	Price adder
Apply price adder to powder coat price		
Custom Power Coat Finish	RAL []	\$50.00
Brite Metallic Powder Coat	MTLPC	\$73.00
Special rust inhibiting primer	Specify	Price adder
Special Rust Inhibitor for Powder Coat Finishes	SRI	\$50.00
Screw package	Specify	Price adder
Wood and Machine Screws (WMS) - Default	-	-
Hold Open Wood and Machine Screws (HWMS) - Default	-	-
Torx Machine Screws	TORX	\$16.00

☞ Handing required

PARTS AND ACCESSORIES

Powder coat

622	Matte Black (MTBLK)
689	Aluminum (AL)
690	Statuary Bronze (STAT)
691	Light Bronze (LTBRZ)
693	Black (GLBLK)
695	Dark Bronze (DKBRZ)
696	Brass (BRASS)

Plated

616	Satin Bronze, Blackened (US11)
632	Brass (US3)
633	Satin Brass (US4)
639	Satin Bronze (US10)
646	Satin Nickel (US15)
651	Bright Chrome (US26)
652	Satin Chrome (US26D)

Anodized

628	Aluminum (ANCLR)
710	Dark Bronze (ANDKB)

Handing

RH	Right hand
LH	Left hand

2010 Series	Specify			Price		
	Part number	Finish	Handing	Powder coat	652 plated	Other plated
Std Cylinder Assembly	2011(3,4,5,6)-3071	.[Finish]	.[Handing]	\$599.00	\$959.00	\$1,108.00
Standard Arm	2010-3077T	.[Finish]	.[Handing]	\$149.00	\$422.00	\$459.00
Standard Track	2010-3038	.[Finish]	-	\$93.00	-	-
Track w/Bumper	2010-3038B	.[Finish]	-	\$98.00	-	-
Track w/Hold Open	2010-3038H	.[Finish]	-	\$123.00	-	-
Track w/Hold Open and Bumper	2010-3038HB	.[Finish]	-	\$135.00	-	-
Screw Pack (incl -3034)	2010-WMS	.[Finish]	-	\$63.00	\$86.00	\$105.00
Screw Pack (incl -3034)	2010-TORX	.[Finish]	-	\$79.00	\$102.00	\$120.00
HO Screw Pack (incl -3034H)	2010-HWMS	.[Finish]	-	\$63.00	\$86.00	\$105.00
HO Screw Pack (incl -3034H)	2010-HTORX	.[Finish]	-	\$79.00	\$102.00	\$120.00
Finish Plate	2010-11	.[Finish]	-	\$63.00	\$247.00	\$284.00
Cover Screw	2010-31	.[Finish]	-	\$7.00	-	-
Arm Screw	2010-159	.[Finish]	-	\$7.00	-	-
Bumper Assembly	2010-169	-	-	\$26.00	-	-
Fire Shield	2010-420	.[Finish]	-	\$81.00	-	-
Roller Lock Screw	2010-425	-	-	\$9.00	-	-
Track Roller	2010-3034	-	-	\$37.00	-	-
Hold Open Track Roller	2010-3034H	-	-	\$37.00	-	-
Hold Open Clip	2010-3054	-	-	\$37.00	-	-
P-1152 Roller	2010-SPL-3034	-	-	\$50.00	-	-
P-1224 Track	2010-SPL-3038	-	-	\$93.00	-	-
HO Roller and Clip	2010-3064H	-	-	\$73.00	-	-
Flat Box w/Label	2010-Flat Box	-	-	\$9.00	-	-
Instruction Sheet	2010-Instruction Sheet	-	-	\$7.00	-	-
Box and Instruction Sheet	2010-Rebox Kit	-	-	\$9.00	-	-

2030 Series	Specify			Price		
	Part number	Finish	Handing	Powder coat	652 plated	Other plated
Std Cylinder Assembly	2031(2,3,4,5)-3071	.[Finish]	.[Handing]	\$1,157.00	\$1,516.00	\$1,665.00
Cylinder Only	2031(2,3,4,5)-3971	.[Finish]	.[Handing]	\$1,071.00	-	-
Standard Arm	2030-3077T	.[Finish]	.[Handing]	\$149.00	\$422.00	\$459.00
Standard Track	2030-3038	.[Finish]	-	\$93.00	-	-
Track w/Bumper	2030-3038B	.[Finish]	-	\$98.00	-	-
Track w/Hold Open	2030-3038H	.[Finish]	-	\$123.00	-	-
Track w/Hold Open and Bumper	2030-3038HB	.[Finish]	-	\$135.00	-	-
Screw Pack (incl -3034)	2030-WMS	.[Finish]	-	\$63.00	\$86.00	\$105.00
Screw Pack (incl -3034)	2030-TORX	.[Finish]	-	\$79.00	\$102.00	\$120.00

Handed

1000 SERIES
4000 SERIES
CONCEALED
FIRE/LIFE SAFETY
HIGH SECURITY
AUTO OPERATORS
ACTUATORS, ACCESSORIES
MISC.

PARTS AND ACCESSORIES

Powder coat

622	Matte Black (MTBLK)
689	Aluminum (AL)
690	Statuary Bronze (STAT)
691	Light Bronze (LTBRZ)
693	Black (GLBLK)
695	Dark Bronze (DKBRZ)
696	Brass (BRASS)

Plated

616	Satin Bronze, Blackened (US11)
632	Brass (US3)
633	Satin Brass (US4)
639	Satin Bronze (US10)
646	Satin Nickel (US15)
651	Bright Chrome (US26)
652	Satin Chrome (US26D)

Anodized

628	Aluminum (ANCLR)
710	Dark Bronze (ANDKB)

Handing

RH	Right hand
LH	Left hand

2030 Series	Specify			Price		
	Part number	Finish	Handing	Powder coat	652 plated	Other plated
HO Screw Pack (incl -3034H)	2030-HWMS	.[Finish]	-	\$63.00	\$86.00	\$105.00
HO Screw Pack (incl -3034H)	2030-HTORX	.[Finish]	-	\$79.00	\$102.00	\$120.00
Arm Screw	2030-159	.[Finish]	-	\$7.00	-	-
Bumper Assembly	2030-169	-	-	\$26.00	-	-
Wood Clip Set	2030-416	.[Finish]	-	\$198.00	\$284.00	\$321.00
Wood Clip Set	2030-417	.[Finish]	-	\$198.00	\$284.00	\$321.00
Fire Shield	2030-420	.[Finish]	-	\$81.00	-	-
Roller Lock Screw	2030-425	-	-	\$9.00	-	-
🔓 Mounting/Finish Plate	2030-3002	.[Finish]	.[Handing]	\$186.00	\$360.00	\$396.00
Track Roller	2030-3034	-	-	\$37.00	-	-
Hold Open Track Roller	2030-3034H	-	-	\$37.00	-	-
Hold Open Clip	2030-3054	-	-	\$37.00	-	-
P-1152 Roller	2030-SPL-3034	-	-	\$50.00	-	-
P-1224 Track	2030-SPL-3038	-	-	\$93.00	-	-
HO Roller and Clip	2030-3064H	-	-	\$73.00	-	-
Flat Box w/Label	2030-Flat Box	-	-	\$9.00	-	-
Instruction Sheet	2030-Instruction Sheet	-	-	\$7.00	-	-
Box and Instruction Sheet	2030-Rebox Kit	-	-	\$9.00	-	-

3030 Series	Specify			Price		
	Part number	Finish	Handing	Powder coat	652 plated	Other plated
🔓 Std Cylinder Assembly	3031(2,3,4)-3071	.[Finish]	.[Handing]	\$433.00	-	-
Reg Arm	3030-3077	.[Finish]	-	\$149.00	\$422.00	\$459.00
🔓 Hold Open Arm	3030-3049	.[Finish]	.[Handing]	\$149.00	\$422.00	\$459.00
Screw Pack	3030-WMS	.[Finish]	-	\$31.00	\$55.00	\$73.00
Screw Pack	3030-TORX	.[Finish]	-	\$49.00	\$71.00	\$90.00
🔓 Hold Open Stud	3030-37	.[Finish]	.[Handing]	\$31.00	-	-
🔓 Hold Open Nut	3030-41	.[Finish]	.[Handing]	\$10.00	-	-
🔓 Hold Open Forearm	3030-48	.[Finish]	.[Handing]	\$86.00	-	-
🔓 Hold Open Main Arm	3030-49	.[Finish]	.[Handing]	\$81.00	-	-
Arm and Forearm	3030-77	.[Finish]	-	\$105.00	-	-
Rod and Shoe	3030-79	.[Finish]	-	\$37.00	\$93.00	\$130.00
H Rod and Shoe	3030-79H	.[Finish]	-	\$37.00	\$93.00	\$130.00
Arm Screw	3030-83	.[Finish]	-	\$7.00	-	-
H Arm Screw	3030-83H	.[Finish]	-	\$7.00	-	-
Arm Screw	3030-159	.[Finish]	-	\$7.00	-	-
Arm Stud	3030-421	.[Finish]	-	\$14.00	-	-

🔓 Handed

3030 Series	Specify			Price		
	Part number	Finish	Handing	Powder coat	652 plated	Other plated
Flat Box w/Label	3030-Flat Box	-	-	\$9.00	-	-
Instruction Sheet	3030-Instruction Sheet	-	-	\$7.00	-	-
Box, Instructions, and Screw Pack	3030-Rebox Kit	-	-	\$9.00	-	-

3130 Series	Specify			Price		
	Part number	Finish	Handing	Powder coat	652 plated	Other plated
Std Cylinder Assembly	3131(2,3)-3071	.[Finish]	.[Handing]	\$464.00	-	-
Standard Arm	3130-3077T	.[Finish]	.[Handing]	\$149.00	\$422.00	\$459.00
Standard Track	3130-3038	.[Finish]	-	\$93.00	-	-
Track w/Bumper	3130-3038B	.[Finish]	-	\$98.00	-	-
Track w/Hold Open	3130-3038H	.[Finish]	-	\$123.00	-	-
Track w/Hold Open and Bumper	3130-3038HB	.[Finish]	-	\$135.00	-	-
Screw Pack (incl -3034)	3130-WMS	.[Finish]	-	\$63.00	\$86.00	\$105.00
Screw Pack (incl -3034)	3130-TORX	.[Finish]	-	\$79.00	\$102.00	\$120.00
HO Screw Pack (incl -3034H)	3130-HWMS	.[Finish]	-	\$63.00	\$86.00	\$105.00
HO Screw Pack (incl -3034H)	3130-HTORX	.[Finish]	-	\$79.00	\$102.00	\$120.00
Channel	3130-2	.[Finish]	.[Handing]	\$14.00	-	-
Arm Screw	3130-159	.[Finish]	-	\$7.00	-	-
Bumper Assembly	3130-169	-	-	\$26.00	-	-
Roller Lock Screw	3130-425	-	-	\$9.00	-	-
Track Roller	3130-3034	-	-	\$37.00	-	-
Hold Open Track Roller	3130-3034H	-	-	\$37.00	-	-
Hold Open Clip	3130-3054	-	-	\$37.00	-	-
Flat Box w/Label	3130-Flat Box	-	-	\$9.00	-	-
Instruction Sheet	3130-Instruction Sheet	-	-	\$7.00	-	-
Box and Instruction Sheet	3130-Rebox Kit	-	-	\$9.00	-	-

5010 Series	Specify			Price		
	Part number	Finish	Handing	Powder coat	652 plated	Other plated
Std Cylinder Assembly	5011(2,3,4,5,6)-3071	.[Finish]	.[Handing]	\$631.00	\$990.00	\$1,139.00
Delayed Action Cylinder Assembly	5011(2,3,4,5)-3071DEL	.[Finish]	.[Handing]	\$686.00	\$1,045.00	\$1,194.00
Reg Arm	5010-3077	.[Finish]	-	\$149.00	\$422.00	\$459.00
Hold Open Arm	5010-3049	.[Finish]	.[Handing]	\$149.00	\$422.00	\$459.00
Screw Pack	5010-WMS	.[Finish]	-	\$31.00	\$55.00	\$73.00
Screw Pack	5010-TORX	.[Finish]	-	\$49.00	\$71.00	\$90.00
Finish Plate	5010-11	.[Finish]	-	\$63.00	\$247.00	\$284.00
DA Finish Plate	5010-11DA	.[Finish]	-	\$63.00	\$247.00	\$284.00
Cover Screw	5010-31	.[Finish]	-	\$7.00	-	-
Hold Open Stud	5010-37	.[Finish]	.[Handing]	\$31.00	-	-
Hold Open Nut	5010-41	.[Finish]	-	\$10.00	-	-
Hold Open Shoe	5010-45	.[Finish]	.[Handing]	\$26.00	-	-
Hold Open Forearm	5010-48	.[Finish]	-	\$86.00	-	-
Hold Open Main Arm	5010-49	.[Finish]	.[Handing]	\$81.00	-	-

Handed

PARTS AND ACCESSORIES

Powder coat

622	Matte Black (MTBLK)
689	Aluminum (AL)
690	Statuary Bronze (STAT)
691	Light Bronze (LTBRZ)
693	Black (GLBLK)
695	Dark Bronze (DKBRZ)
696	Brass (BRASS)

Plated

616	Satin Bronze, Blackened (US11)
632	Brass (US3)
633	Satin Brass (US4)
639	Satin Bronze (US10)
646	Satin Nickel (US15)
651	Bright Chrome (US26)
652	Satin Chrome (US26D)

Anodized

628	Aluminum (ANCLR)
710	Dark Bronze (ANDKB)

Handing

RH	Right hand
LH	Left hand

5010 Series	Specify			Price		
	Part number	Finish	Handing	Powder coat	652 plated	Other plated
Arm and Forearm	5010-77	.[Finish]	-	\$149.00	-	-
Rod and Shoe	5010-79	.[Finish]	-	\$37.00	\$93.00	\$130.00
H Rod and Shoe	5010-79H	.[Finish]	-	\$37.00	\$93.00	\$130.00
Arm Screw	5010-83	.[Finish]	-	\$7.00	-	-
H Arm Screw	5010-83H	.[Finish]	-	\$7.00	-	-
Arm Stud	5010-95	.[Finish]	-	\$19.00	-	-
Arm Screw	5010-159	.[Finish]	-	\$7.00	-	-
⚡ Mounting/Finish Plate	5010-3002	.[Finish]	.[Handing]	\$86.00	-	-
Flat Box w/Label	5010-Flat Box	-	-	\$9.00	-	-
Instruction Sheet	5010-Instruction Sheet	-	-	\$7.00	-	-
Box and Instruction Sheet	5010-Rebox Kit	-	-	\$9.00	-	-

5030 Series	Specify			Price		
	Part number	Finish	Handing	Powder coat	652 plated	Other plated
⚡ Std Cylinder Assembly	5031(3,4,5,6)-3071	.[Finish]	.[Handing]	\$1,157.00	\$1,516.00	\$1,665.00
⚡ Cylinder Only	5031(3,4,5,6)-3971	.[Finish]	.[Handing]	\$1,071.00	-	-
Reg Arm	5030-3077	.[Finish]	-	\$149.00	\$422.00	\$459.00
⚡ Hold Open Arm	5030-3049	.[Finish]	.[Handing]	\$149.00	\$422.00	\$459.00
Screw Pack	5030-WMS	.[Finish]	-	\$31.00	\$55.00	\$73.00
Screw Pack	5030-TORX	.[Finish]	-	\$49.00	\$71.00	\$90.00
⚡ Hold Open Stud	5030-37	.[Finish]	.[Handing]	\$31.00	-	-
Hold Open Nut	5030-41	.[Finish]	-	\$10.00	-	-
Hold Open Forearm	5030-48	.[Finish]	-	\$86.00	-	-
⚡ Hold Open Main Arm	5030-49	.[Finish]	.[Handing]	\$81.00	\$186.00	\$224.00
⚡ Arm and Forearm	5030-77	.[Finish]	.[Handing]	\$149.00	\$321.00	\$360.00
Rod and Shoe	5030-79	.[Finish]	-	\$37.00	\$93.00	\$130.00
H Rod and Shoe	5030-79H	.[Finish]	-	\$37.00	\$93.00	\$130.00
Arm Screw	5030-83	.[Finish]	-	\$7.00	-	-
H Arm Screw	5030-83H	.[Finish]	-	\$7.00	-	-
Arm Screw	5030-159	.[Finish]	-	\$7.00	-	-
Wood Clip Set	5030-416	.[Finish]	-	\$198.00	\$284.00	\$321.00
Wood Clip Set	5030-417	.[Finish]	-	\$198.00	\$284.00	\$321.00
⚡ Mounting/Finish Plate	5030-3002	.[Finish]	.[Handing]	\$186.00	\$360.00	\$396.00
Flat Box w/Label	5030-Flat Box	-	-	\$9.00	-	-
Instruction Sheet	5030-Instruction Sheet	-	-	\$7.00	-	-
Box and Instruction Sheet	5030-Rebox Kit	-	-	\$9.00	-	-

⚡ Handed

6030 Series	Specify			Price		
	Part number	Finish	Handing	Powder coat	652 plated	Other plated
Std Cylinder Assembly	6031(2,3,4,5)-3071	.[Finish]	-	\$1,435.00	\$1,795.00	\$1,944.00
Cylinder Only	6031(2,3,4,5)-3971	.[Finish]	-	\$1,238.00	-	-
Standard Arm	6030-3077T	.[Finish]	-	\$149.00	\$422.00	\$459.00
Track w/Bumper	6030-3038B	.[Finish]	-	\$98.00	-	-
Track w/Hold Open and Bumper	6030-3038HB	.[Finish]	-	\$135.00	-	-
Screw Pack (incl -3034)	6030-WMS	.[Finish]	-	\$63.00	\$86.00	\$105.00
Screw Pack	6030-HWMS	.[Finish]	-	\$63.00	\$86.00	\$105.00
Screw Pack (incl -3034)	6030-TORX	.[Finish]	-	\$79.00	\$102.00	\$120.00
Arm Screw	6030-83	.[Finish]	-	\$7.00	-	-
Snubber	6030-157	-	-	\$19.00	-	-
Arm Screw	6030-159	.[Finish]	-	\$7.00	-	-
Bumper Assembly	6030-169	-	-	\$26.00	-	-
Wood Clip Set	6030-416	.[Finish]	-	\$198.00	\$284.00	\$321.00
Roller Lock Screw	6030-425	-	-	\$9.00	-	-
Mounting/Finish Plate	6030-3002	.[Finish]	-	\$247.00	\$273.00	\$310.00
Track Roller	6030-3034	-	-	\$43.00	-	-
Hold Open Track Roller	6030-3034H	-	-	\$43.00	-	-
Hold Open Clip	6030-3054	.[Finish]	-	\$37.00	-	-
Flat Box w/Label	6030-Flat Box	-	-	\$9.00	-	-
Instruction Sheet	6030-Instruction Sheet	-	-	\$7.00	-	-
Box and Instruction Sheet	6030-Rebox Kit	-	-	\$9.00	-	-

Handed

3130SE SERIES

The 3130SE SENTRONIC® is a concealed in the door, closer/ holder designed to provide single point hold-open for fire and smoke barrier doors. Door is held open until current interruption releases the holding mechanism and the door closes. Single lever (track) arm closer is specifically designed for interior doors.

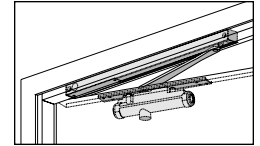

689	690	691	693	695	696	652	616	632	633	639	646	651
AL	STAT	LTBRZ	GLBLK	DKBRZ	BRASS	US26D	US11	US3	US4	US10	US15	US26

ACN for these commonly ordered products	PRICE BASED ON FINISH				
	POWDER COAT		PLATED		
	689	690	616	632	651
691	693	633	639	651	
695	696	646	651		

DEFAULT CONFIGURATIONS					
Model	Track	Finish	Handing	Voltage	
☞ [3133SE, 3134SE]	STDTRK	[Finish]	[RH, LH]	[24, 120]	\$1,134.00 \$1,404.00 \$1,441.00
☞ [3133SE, 3134SE]	LONG	[Finish]	[RH, LH]	[24, 120]	\$1,144.00 \$1,418.00 \$1,454.00

DEFAULT AND COMMON CONFIGURATIONS
 Pricing includes default options shown below unless otherwise specified. Specification rules, additional options and pricing adders are shown in the tables below.

Cylinder
 Cast Iron Cylinder Assembly (CYL)

Arm type
 Standard Arm (STDTRKARM)

Screw package
 Wood and Machine Screws (WMS)

BAA Compliant
 See the [Allegion Buy America/ Buy American and Trade Agreement Acts \(BAA and TAA\) Compliance Guide](#) for full details

SPECIFICATION RULES, ADDITIONAL OPTIONS AND PRICING ADDERS

Order of attributes when placing an order for a non-standard configuration. See parts section for individual parts pricing. Attributes show in CAPS are required. Other attributes are required only if you are deviating from the product's default.

MODEL . TRACK TYPE . FINISH . Screw package . HANDING . Door thickness . VOLTAGE

Custom powder coat finishes	Specify	Price adder
Apply price adder to powder coat price		
Custom Power Coat Finish	RAL []	\$50.00
Brite Metallic Powder Coat	MTLPC	\$73.00
Screw package	Specify	Price adder
Wood and Machine Screws (WMS) - Default	-	-
Torx Machine Screws	TORX	\$16.00
Door thickness	Specify	
Specify if door thickness is different than 1-3/4" when choosing a through bolt screw pack	[]	

☞ Handing required

4040SE SERIES

The 4040SE SENTRONIC® is a heavy duty, non-handed, nonsized closer/holder designed to provide single point hold-open for fire and smoke barrier doors. The door is held open until current interruption releases the holding mechanism and the door closes. Single lever (track) arm closer is specifically designed for interior doors. Choice of finishes, track functions, and installation accessories meet virtually all life safety requirements.

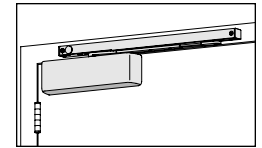

689	690	691	693	695	696	652	616	632	633	639	646	651
AL	STAT	LTBRZ	GLBLK	DKBRZ	BRASS	US26D	US11	US3	US4	US10	US15	US26

ACN for these commonly ordered products						PRICE BASED ON FINISH					
						POWDER COAT		PLATED (INCLUDES METAL COVER)			
						689	690		616	632	
						691	693	652	633	639	
						695	696		646	651	
DEFAULT CONFIGURATIONS											
Model	Arm	Track	Finish	Voltage							
4040SE	STDTRKARM	STDTRK	[Finish]	[24, 120]		\$1,146.00		\$1,652.00		\$1,750.00	
4040SE	STDTRKARM	LONG	[Finish]	[24, 120]		\$1,146.00		\$1,652.00		\$1,750.00	
4040SE	DE	STDTRK	[Finish]	[24, 120]		\$1,206.00		\$1,714.00		\$1,813.00	
ADDITIONAL COMMON CONFIGURATIONS											
Model	Arm	Track	Finish	Screw pack	Voltage						
4040SE	STDTRKARM	STDTRK	[Finish]	TBWMS	[24, 120]	\$1,146.00		\$1,652.00		\$1,750.00	

DEFAULT AND COMMON CONFIGURATIONS
Pricing includes default options shown below unless otherwise specified. Specification rules, additional options and pricing adders are shown in the tables below.

Cylinder
Cast Iron Cylinder Assembly (CYL)

Cover
Plastic Cover (PC)

Screw package
Wood and Machine Screws (WMS)

BAA Compliant
See the [Allegion Buy America/ Buy American and Trade Agreement Acts \(BAA and TAA\) Compliance Guide](#) for full details

SPECIFICATION RULES, ADDITIONAL OPTIONS AND PRICING ADDERS

Order of attributes when placing an order for a non-standard configuration. See parts section for individual parts pricing. Attributes show in CAPS are required. Other attributes are required only if you are deviating from the product's default.

MODEL . TRACK TYPE . FINISH . Cover . Handing . Screw package . Door thickness . VOLTAGE

Custom powder coat finishes	Specify	Price adder
Apply price adder to powder coat price		
Custom Power Coat Finish - Requires metal cover	RAL []	\$50.00
Brite Metallic Powder Coat - Requires metal cover	MTLPC	\$73.00
Cover	Specify	Price adder
Metal Cover - Included for plated finishes	MC	\$19.00
Plastic Cover (PC) - Default	-	-
Screw package	Specify	Price adder
Wood and Machine Screws (WMS) - Default	-	-
Through Bolt Wood and Machine Screws	TBWMS	\$0.00
Torx Machine Screws	TORX	\$16.00
Through Bolt and Torx Machine Screws	TBTRX	\$16.00

Door thickness	Specify
Specify if door thickness is different than 1-3/4" when choosing a through bolt screw pack	[]

☞ Handing required

4040SEH SERIES

The SEH SENTRONIC® is a holder designed to provide single point hold-open for fire and smoke barrier doors that must be used with an opposite side mounted UL listed door closer. The door is held open until current interruption releases the holding mechanism and the door closes. Single lever (track) arm is specifically designed for interior doors. Choice of finishes, track functions, and installation accessories meet virtually all life safety requirements.

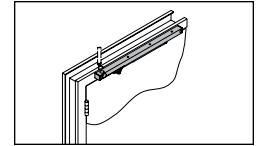

689	690	691	693	695	696	652	616	632	633	639	646	651	
AL	STAT	LTBRZ	GLBLK	DKBRZ	BRASS	US26D	US11	US3	US4	US10	US15	US26	
ACN for these commonly ordered products							PRICE BASED ON FINISH						
							POWDER COAT			PLATED			
							689	690		616	632		
							691	693	652	633	639		
			646	651									
DEFAULT CONFIGURATIONS													
Model . Finish . Voltage													
4040SEH . [Finish] . [24, 120]							\$725.00	\$996.00	\$1,032.00				

DEFAULT AND COMMON CONFIGURATIONS

Pricing includes default options shown below unless otherwise specified. Specification rules, additional options and pricing adders are shown in the tables below.

Arm type
Standard SEH Arm (SEH)

Track type
Standard Track (STDTRK)

Screw package
Wood and Machine Screws (WMS)

SPECIFICATION RULES, ADDITIONAL OPTIONS AND PRICING ADDERS

Order of attributes when placing an order for a non-standard configuration. See parts section for individual parts pricing. Attributes show in CAPS are required. Other attributes are required only if you are deviating from the product's default.

MODEL . FINISH . Screw package . Door thickness . VOLTAGE

Custom powder coat finishes	Specify	Price adder
Apply price adder to powder coat price		
Custom Power Coat Finish - Requires metal cover	RAL []	\$50.00
Brite Metallic Powder Coat - Requires metal cover	MTLPC	\$73.00
Screw package	Specify	Price adder
Wood and Machine Screws (WMS) - Default	-	-
Metric Wood and Machine Screws	MWMS	\$0.00
Through Bolt Wood and Machine Screws	TBWMS	\$0.00
Door thickness	Specify	
Specify if door thickness is different than 1-3/4" when choosing a through bolt screw pack	[]	

☞ Handing required

2310ME SERIES

The 2310ME SENTRONIC® is a concealed heavy duty, electrically controlled closer/holder designed to provide infinitely adjustable hold-open for fire and smoke barrier doors. Door is held open until current interruption releases mechanism and the door closes. Single lever (track) arm closer is specifically designed for interior doors. Choice of finishes, cylinder functions, and installation accessories meet virtually all life safety requirements.

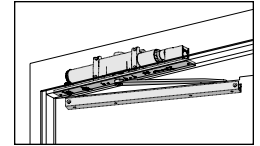

689	690	691	693	695	696	652	616	632	633	639	646	651
AL	STAT	LTBRZ	GLBLK	DKBRZ	BRASS	US26D	US11	US3	US4	US10	US15	US26
ACN for these commonly ordered products						PRICE BASED ON FINISH						
						POWDER COAT		PLATED				
						689	690		616	632		
						691	693	652	633	639		
						695	696		646	651		
DEFAULT CONFIGURATIONS												
Model . Finish . Handing . Voltage												
🔩	2314ME	. [Finish]	. [RH, LH]	. [24, 120]		\$1,569.00		\$2,023.00			\$2,134.00	

DEFAULT AND COMMON CONFIGURATIONS

Pricing includes default options shown below unless otherwise specified. Specification rules, additional options and pricing adders are shown in the tables below.

Cylinder

Cast Iron Cylinder Assembly (CYL)

Arm type

Standard Track Arm (STDTRKARM)

Arm type

Standard Track (STDTRK)

Cover

Metal Cover

Screw package

Wood and Machine Screws (WMS)

BAA Compliant

See the [Allegion Buy America/ Buy American and Trade Agreement Acts \(BAA and TAA\) Compliance Guide](#) for full details

SPECIFICATION RULES, ADDITIONAL OPTIONS AND PRICING ADDERS

Order of attributes when placing an order for a non-standard configuration. See parts section for individual parts pricing. Attributes show in CAPS are required. Other attributes are required only if you are deviating from the product's default.

MODEL . Cylinder . TRACK TYPE . FINISH . HANDING . Screw package . Door thickness . VOLTAGE

Cylinder	Specify	Price adder
🔩 Cast Iron Cylinder Assembly (CYL) - Default	-	-
🔩 Bypass Hold Open up to 80 Degrees	CYLB80	\$93.00
🔩 Bypass Hold Open up to 140 Degrees	CYLB140	\$93.00
Custom powder coat finishes	Specify	Price adder
Apply price adder to powder coat price		
Custom Power Coat Finish	RAL []	\$50.00
Brite Metallic Powder Coat	MTLPC	\$73.00
Screw package	Specify	Price adder
Wood and Machine Screws (WMS) - Default	-	-
Through Bolt Wood and Machine Screws	TBWMS	\$0.00
Torx Machine Screws	TORX	\$16.00
Through Bolt and Torx Machine Screws	TBTRX	\$16.00

Door thickness	Specify
Specify if door thickness is different than 1-3/4" when choosing a through bolt screw pack	[]

🔩 Handing required

4310ME SERIES

The 4310ME SENTRONIC® is a heavy duty, electrically controlled closer/holder designed to provide infinitely adjustable hold-open for fire and smoke barrier doors. Door is held open until current interruption releases mechanism and the door closes. Single lever (track) arm closer is specifically designed for interior doors. Choice of finishes, cylinder functions, and installation accessories meet virtually all life safety requirements. An ME provides only the closer / holder function.

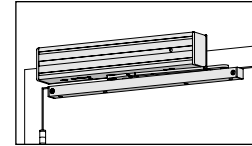

689	690	691	693	695	696	652	616	632	633	639	646	651
AL	STAT	LTBRZ	GLBLK	DKBRZ	BRASS	US26D	US11	US3	US4	US10	US15	US26

ACN for these commonly ordered products	PRICE BASED ON FINISH				
	POWDER COAT		PLATED		
	689	690	616	632	639
691	693	652	633	639	
695	696	646	651		

DEFAULT CONFIGURATIONS				
Model	Finish	Handing	Voltage	
🔩 4314ME	[Finish]	[RH, LH]	[24, 120]	\$1,606.00 \$2,092.00 \$2,408.00

DEFAULT AND COMMON CONFIGURATIONS

Pricing includes default options shown below unless otherwise specified. Specification rules, additional options and pricing adders are shown in the tables below.

Cylinder
Cast Iron Cylinder Assembly (CYL)

Arm type
Swing Free Arm (SF)

Track type
Standard Track (STDTRK)

Cover
Metal Cover

Screw package
Wood and Machine Screws (WMS)

BAA Compliant
See the [Allegion Buy America/ Buy American and Trade Agreement Acts \(BAA and TAA\) Compliance Guide](#) for full details

SPECIFICATION RULES, ADDITIONAL OPTIONS AND PRICING ADDERS

Order of attributes when placing an order for a non-standard configuration. See parts section for individual parts pricing. Attributes show in CAPS are required. Other attributes are required only if you are deviating from the product's default.

MODEL . Cylinder . Arm type . FINISH . HANDING . Screw package . Door thickness

Cylinder	Specify	Price adder
🔩 Cast Iron Cylinder Assembly (CYL) - Default	-	-
🔩 Bypass Hold Open up to 80 Degrees	CYLB80	\$104.00
🔩 Bypass Hold Open up to 140 Degrees	CYLB140	\$104.00
Arm type	Specify	Price adder
🔩 Swing Free Arm (SF) - Default	-	-
🔩 Double Egress Arm	DE	\$60.00
Custom powder coat finishes	Specify	Price adder
Apply price adder to powder coat price		
Custom Power Coat Finish	RAL []	\$50.00
Brite Metallic Powder Coat	MTLPC	\$73.00

Screw package	Specify	Price adder
Wood and Machine Screws (WMS) - Default	-	-
Through Bolt Wood and Machine Screws	TBWMS	\$0.00
Torx Machine Screws	TORX	\$16.00
Through Bolt and Torx Machine Screws	TBTRX	\$16.00
Door thickness	Specify	
Specify if door thickness is different than 1-3/4" when choosing a through bolt screw pack	[]	

🔩 Handing required

4410ME SERIES

The 4410ME SENTRONIC® is a heavy duty, electrically controlled closer/holder designed to provide infinitely adjustable hold-open for fire and smoke barrier doors. Door is held open until current interruption releases mechanism and the door closes. Double lever arm closer is specifically designed for interior doors. Choice of finishes, cylinder functions, and installation accessories meet virtually all life safety requirements.

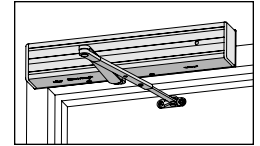

689	690	691	693	695	696	652	616	632	633	639	646	651
AL	STAT	LTBRZ	GLBLK	DKBRZ	BRASS	US26D	US11	US3	US4	US10	US15	US26

ACN for these commonly ordered products	PRICE BASED ON FINISH				
	POWDER COAT		PLATED		
	689	690	616	632	651
691	693	652	633	639	
695	696	646	651		

DEFAULT CONFIGURATIONS					
Model	Arm	Finish	Handing	Voltage	
4414ME	REGARM	[Finish]	[RH, LH]	[24, 120]	\$1,518.00
4414ME	LONG	[Finish]	[RH, LH]	[24, 120]	\$1,523.00

DEFAULT AND COMMON CONFIGURATIONS

Pricing includes default options shown below unless otherwise specified. Specification rules, additional options and pricing adders are shown in the tables below.

Cylinder
Cast Iron Cylinder Assembly (CYL)

Cover
Metal Cover

Screw package
Wood and Machine Screws (WMS)

BAA Compliant
See the [Allegion Buy America/ Buy American and Trade Agreement Acts \(BAA and TAA\) Compliance Guide](#) for full details

SPECIFICATION RULES, ADDITIONAL OPTIONS AND PRICING ADDERS

Order of attributes when placing an order for a non-standard configuration. See parts section for individual parts pricing. Attributes show in CAPS are required. Other attributes are required only if you are deviating from the product's default.

MODEL . ARM TYPE . FINISH . HANDING . Screw package . Door thickness . VOLTAGE

Cylinder	Specify	Price adder
Cast Iron Cylinder Assembly (CYL) - Default	-	-
Standard Cylinder with 18G Mounting plate	CYL18G	-
Bypass Hold Open up to 80 Degrees	CYLB80	\$104.00
Bypass Hold Open up to 140 Degrees	CYLB140	\$104.00
Custom powder coat finishes	Specify	Price adder
Apply price adder to powder coat price		
Custom Power Coat Finish	RAL []	\$50.00
Brite Metallic Powder Coat	MTLPC	\$73.00

Screw package	Specify	Price adder
Wood and Machine Screws (WMS) - Default	-	-
Through Bolt Wood and Machine Screws	TBWMS	\$0.00
Torx Machine Screws	TORX	\$16.00
Through Bolt and Torx Machine Screws	TBTRX	\$16.00
Door thickness	Specify	
Specify if door thickness is different than 1-3/4" when choosing a through bolt screw pack	[]	

Handing required

4310HSA SERIES

The 4310HSA SENTRONIC® is an electrically controlled closer/holder designed to provide easy passage for groups of pedestrians through high traffic doors. Pedestrians, moving through the doorway, trigger the built-in scanner. When the door is opened to 80° or more, the door is electrically held open to minimize wear and tear on applied door hardware. After the last pedestrian in a group passes through the doorway, the system timer releases the hold-open, closing the door under control of the heavy duty closer. Single lever (track) arm closer is specifically designed for pull side mounting. Choice of finishes and accessories meet virtually all high traffic installation requirements.

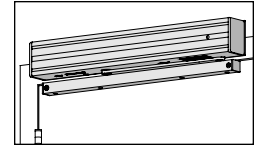

DEFAULT AND COMMON CONFIGURATIONS

Pricing includes default options shown below unless otherwise specified. Specification rules, additional options and pricing adders are shown in the tables below.

Cylinder
Cast Iron Cylinder Assembly (CYL)

Arm type
Standard Track Arm (STDTRKARM)

Track type
Standard Track (STDTRK)

Cover
Metal Cover

Screw package
Wood and Machine Screws (WMS)

Voltage
24 Volts

BAA Compliant
See the [Allegion Buy America/ Buy American and Trade Agreement Acts \(BAA and TAA\) Compliance Guide](#) for full details

689 690 691 693 695 696 652 616 632 633 639 646 651														
AL STAT LTBRZ GLBLK DKBRZ BRASS US26D US11 US3 US4 US10 US15 US26														
ACN for these commonly ordered products			PRICE BASED ON FINISH											
			POWDER COAT		PLATED									
			689	690									616	632
			691	693	652								633	639
			695	696									646	651
DEFAULT CONFIGURATIONS														
Model . Finish . Handing														
4311HSA . [Finish] . [RH, LH]			\$1,710.00		\$2,196.00								\$2,512.00	

SPECIFICATION RULES, ADDITIONAL OPTIONS AND PRICING ADDERS

Order of attributes when placing an order for a non-standard configuration. See parts section for individual parts pricing. Attributes show in CAPS are required. Other attributes are required only if you are deviating from the product's default.

MODEL . Arm type . FINISH . HANDING . Screw package . Door thickness

Arm type	Specify	Price adder
Standard Track Arm (STDTRKARM) - Default	-	-
Double Egress Arm	DE	\$60.00
Custom powder coat finishes	Specify	Price adder
Apply price adder to powder coat price		
Custom Power Coat Finish	RAL []	\$50.00
Brite Metallic Powder Coat	MTLPC	\$73.00
Screw package	Specify	Price adder
Wood and Machine Screws (WMS) - Default	-	-
Through Bolt Wood and Machine Screws	TBWMS	\$0.00
Torx Machine Screws	TORX	\$16.00
Through Bolt and Torx Machine Screws	TBTRX	\$16.00

Door thickness	Specify
Specify if door thickness is different than 1-3/4" when choosing a through bolt screw pack	[]

☞ Handing required

4410HSA SERIES

The 4410HSA SENTRONIC® is an electrically controlled closer/holder designed to provide easy passage for groups of pedestrians through high traffic doors. Pedestrians, moving through the doorway, trigger the built-in scanner. When the door is opened to 80° or more, the door is electrically held open to minimize wear and tear on applied door hardware. After the last pedestrian in a group passes through the doorway, the system timer releases the hold-open, closing the door under control of the heavy duty closer. Double lever arm closer is specifically designed for push side mounting. Choice of finishes and accessories meet virtually all high traffic installation requirements.

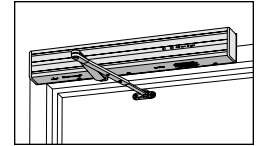

689	690	691	693	695	696	652	616	632	633	639	646	651
AL	STAT	LTBRZ	GLBLK	DKBRZ	BRASS	US26D	US11	US3	US4	US10	US15	US26

ACN for these commonly ordered products	PRICE BASED ON FINISH			
	POWDER COAT		PLATED	
	689	690	616	632
691	693	652	633 639	
695	696	646	651	

DEFAULT CONFIGURATIONS				
Model	Arm	Finish	Handing	
4412HSA	REGARM	[Finish]	[RH, LH]	\$1,622.00 \$2,111.00 \$2,427.00
4412HSA	LONG	[Finish]	[RH, LH]	\$1,627.00 \$2,117.00 \$2,432.00

DEFAULT AND COMMON CONFIGURATIONS

Pricing includes default options shown below unless otherwise specified. Specification rules, additional options and pricing adders are shown in the tables below.

Cylinder
Cast Iron Cylinder Assembly (CYL)

Cover
Metal Cover

Screw package
Wood and Machine Screws (WMS)

Voltage
24 Volts

BAA Compliant
See the [Allegion Buy America/ Buy American and Trade Agreement Acts \(BAA and TAA\) Compliance Guide](#) for full details

SPECIFICATION RULES, ADDITIONAL OPTIONS AND PRICING ADDERS

Order of attributes when placing an order for a non-standard configuration. See parts section for individual parts pricing. Attributes show in CAPS are required. Other attributes are required only if you are deviating from the product's default.

MODEL . Cylinder . ARM TYPE . FINISH . HANDING . Screw package . Door thickness

Cylinder	Specify	Price adder
Cast Iron Cylinder Assembly (CYL) - Default	-	-
Standard Cylinder with 18G Mounting Plate	CYL18G	\$0.00
Custom powder coat finishes	Specify	Price adder
Apply price adder to powder coat price		
Custom Power Coat Finish	RAL []	\$50.00
Brite Metallic Powder Coat	MTLPC	\$73.00
Screw package	Specify	Price adder
Wood and Machine Screws (WMS) - Default	-	-
Through Bolt Wood and Machine Screws	TBWMS	\$0.00
Torx Machine Screws	TORX	\$16.00

Screw package	Specify	Price adder
Through Bolt and Torx Machine Screws	TBTRX	\$16.00
Door thickness	Specify	
Specify if door thickness is different than 1-3/4" when choosing a through bolt screw pack	[]	

☞ Handing required

SEM MAGNETS

The Sentronic® SEM 7800 Series are heavy duty, electrically controlled door holding magnets. Magnets are fail safe and hold until the current is interrupted. A manual door closer is used to control and close the door. A choice of floor, recessed wall, or surface mounted wall magnets are available.

ACN for these commonly ordered products	PRICING FOR POWDER COAT FINISHES	
	689 (AL)	695 (DKBRZ)
DEFAULT CONFIGURATIONS		
Model . Finish		
SEM7820 . [Finish]		\$886.00
SEM7830 . [Finish]		\$501.00
SEM7840 . [Finish]		\$501.00
SEM7850 . [Finish]		\$501.00

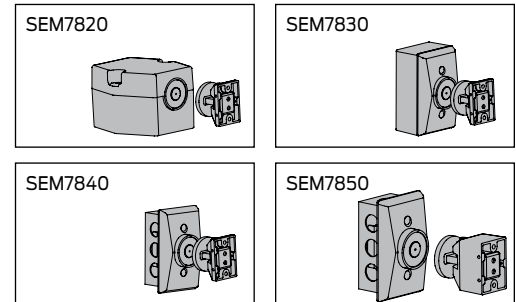

DEFAULT AND COMMON CONFIGURATIONS

Pricing includes default options shown below unless otherwise specified.

Voltage

12V, 24V, 120V Tri Voltage (TRIV)

SEM7800 Series	Specify		Price
	Part number	Finish	Powder coat
SEM7810 Kit	SEM7810-517	.[Finish]	\$1,264.00
Extension 1/2"	SEM7810-E050	.[Finish]	\$31.00
Extension 3/4"	SEM7810-E075	.[Finish]	\$37.00
Extension 1"	SEM7810-E100	.[Finish]	\$37.00
Extension 2"	SEM7810-E200	.[Finish]	\$50.00
Extension 4"	SEM7810-E400	.[Finish]	\$50.00
Ball Pivot/Connection Link	SEM7810-514	.[Finish]	\$37.00
Fastener Kit	SEM7820-515	.[Finish]	\$81.00
Standard Cover and Base	SEM7820-72	.[Finish]	\$620.00
Door Armature	SEM7820-825	.[Finish]	\$161.00
Magnet Core Assembly	SEM7820-516	.[Finish]	\$211.00
Fastener Kit	SEM7830-515	.[Finish]	\$31.00
Standard Cover	SEM7830-72	.[Finish]	\$123.00
Surface Mount Box	SEM7830-268	.[Finish]	\$43.00
Magnet Core Assembly	SEM7830-516	.[Finish]	\$211.00
Door Armature	SEM7830-825	.[Finish]	\$161.00
Fastener Kit	SEM7840-515	.[Finish]	\$31.00
Standard Cover	SEM7840-72	.[Finish]	\$123.00
Magnet Core Assembly	SEM7840-516	.[Finish]	\$211.00
Door Armature	SEM7840-825	.[Finish]	\$161.00
Fastener Kit and Bracket	SEM7850-515	.[Finish]	\$31.00
Magnet Core Assembly	SEM7850-516	.[Finish]	\$211.00
Standard Cover	SEM7850-72	.[Finish]	\$123.00
Door Armature	SEM7850-828	.[Finish]	\$235.00

✎ Handing required

PARTS AND ACCESSORIES

Powder coat

689	Aluminum (AL)
690	Statuary Bronze (STAT)
691	Light Bronze (LTBRZ)
693	Black (GLBLK)
695	Dark Bronze (DKBRZ)
696	Brass (BRASS)

Plated

616	Satin Bronze, Blackened (US11)
632	Brass (US3)
633	Satin Brass (US4)
639	Satin Bronze (US10)
646	Satin Nickel (US15)
651	Bright Chrome (US26)
652	Satin Chrome (US26D)

Anodized

628	Aluminum (ANCLR)
710	Dark Bronze (ANDKB)

Handing

RH	Right hand
LH	Left hand

3130SE Series	Specify				Price		
	Part number	Finish	Handing	Voltage	Powder coat	652 plated	Other plated
Std Cylinder Assembly	3133(4)SE-3071	-	.[Handing]	-	\$489.00	-	-
Standard Arm	3130SE-3077T	.[Finish]	.[Handing]	-	\$144.00	\$414.00	\$451.00
Long Arm	3130SE-3077L	.[Finish]	.[Handing]	-	\$154.00	\$428.00	\$464.00
Standard Track	3130SE-3038	.[Finish]	-	.[24, 120]	\$501.00	-	-
Long Track	3130SEL-3038SEL	.[Finish]	-	.[24, 120]	\$501.00	-	-
Screw Pack (incl. -81)	3130SE-WMS	.[Finish]	-	-	\$31.00	\$55.00	\$73.00
Screw Pack (incl. -81)	3130SE-TORX	.[Finish]	-	-	\$49.00	\$71.00	\$90.00
Cover Plate	3130SE-59A	-	-	-	\$9.00	-	-
Cover Plate Screw	3130SE-60	-	-	-	\$7.00	-	-
End Cap	3130SE-73	-	-	-	\$14.00	-	-
Arm and Tube	3130SE-78	-	-	-	\$93.00	-	-
Connector w/Ring	3130SE-81	-	-	-	\$9.00	-	-
Rod	3130SE-82	-	-	-	\$73.00	-	-
H Arm Screw	3130SE-83H	-	-	-	\$7.00	-	-
Arm Screw	3130SE-159	-	-	-	\$7.00	-	-
Track Roller with Slider	3130SE-3034SE	-	-	-	\$43.00	-	-
Roller Lock Screw	3130SE-425	-	-	-	\$9.00	-	-
Transformer	3130SE-3210	-	-	-	\$93.00	-	-
On/off Switch Assembly	3130SE-3436	-	-	-	\$93.00	-	-
Flat Box w/Label	3130SE-Flat Box	-	-	-	\$9.00	-	-
Instruction Sheet	3130SE-Instruction Sheet	-	-	-	\$7.00	-	-
Box and Instruction Sheet	3130SE-Rebox Kit	-	-	-	\$9.00	-	-

4040SE Series	Specify				Price		
	Part number	Finish	Handing	Voltage	Powder coat	652 plated	Other plated
Std Cylinder Assembly	4040SE-3071	-	-	-	\$470.00	-	-
Standard Arm	4040SE-3077T	.[Finish]	-	-	\$144.00	\$414.00	\$451.00
DE Arm	4040SE-3077DE	.[Finish]	.[Handing]	-	\$204.00	\$476.00	\$514.00
Standard Track	4040SE-3038	.[Finish]	-	.[24, 120]	\$501.00	-	-
Long Track	4040SEL-3038SEL	.[Finish]	-	.[24, 120]	\$501.00	-	-
Standard Cover	4040SE-72	.[Finish]	-	-	\$31.00	-	-
Metal Cover	4040SE-72MC	.[Finish]	.[Handing]	-	\$50.00	\$267.00	\$328.00
Screw Pack (inc. -81)	4040SE-WMS	.[Finish]	-	-	\$31.00	\$55.00	\$73.00
Screw Pack (inc. -81)	4040SE-TBWMS	.[Finish]	-	-	\$31.00	\$55.00	\$73.00
Screw Pack (inc. -81)	4040SE-TORX	.[Finish]	-	-	\$49.00	\$71.00	\$90.00
Screw Pack (inc. -81)	4040SE-TBTRX	.[Finish]	-	-	\$49.00	\$71.00	\$90.00

Handed

1000 SERIES
4000 SERIES
CONCEALED
FIRE/LIFE SAFETY
HIGH SECURITY
AUTO OPERATORS
ACTUATORS, ACCESSORIES
MISC.

PARTS AND ACCESSORIES

Powder coat

689	Aluminum (AL)
690	Statuary Bronze (STAT)
691	Light Bronze (LTBRZ)
693	Black (GLBLK)
695	Dark Bronze (DKBRZ)
696	Brass (BRASS)

Plated

616	Satin Bronze, Blackened (US11)
632	Brass (US3)
633	Satin Brass (US4)
639	Satin Bronze (US10)
646	Satin Nickel (US15)
651	Bright Chrome (US26)
652	Satin Chrome (US26D)

Anodized

628	Aluminum (ANCLR)
710	Dark Bronze (ANDKB)

Handing

RH	Right hand
LH	Left hand

4040SE Series	Specify				Price		
	Part number	Finish	Handing	Voltage	Powder coat	652 plated	Other plated
Plate	4040SE-18	.[Finish]	-	-	\$73.00	\$260.00	\$298.00
Plate	4040SE-18PA	.[Finish]	-	-	\$73.00	\$260.00	\$298.00
Cover Screw	4040SE-31	-	-	-	\$7.00	-	-
Cover Plate	4040SE-59A	-	-	-	\$9.00	-	-
Cover Plate Screw	4040SE-60	-	-	-	\$7.00	-	-
Spacer	4040SE-61	-	-	-	\$19.00	-	-
End Cap	4040SE-73	-	-	-	\$14.00	-	-
Arm and Tube	4040SE-78	-	-	-	\$93.00	-	-
☞ Main Arm and Tube	4040SE-78DE	-	.[Handing]	-	\$98.00	-	-
Connector w/Ring	4040SE-81	-	-	-	\$9.00	-	-
Rod	4040SE-82	-	-	-	\$73.00	-	-
H Arm Screw	4040SE-83H	-	-	-	\$7.00	-	-
Plug	4040SE-141	-	-	-	\$7.00	-	-
Plug	4040SE-141-1	-	-	-	\$7.00	-	-
Plug	4040SE-141-2	-	-	-	\$7.00	-	-
Arm Screw	4040SE-159	-	-	-	\$7.00	-	-
Roller Lock Screw	4040SE-425	-	-	-	\$9.00	-	-
Track Roller with slider	4040SE-3034SE	-	-	-	\$43.00	-	-
SE Transformer	4040SE-3210	-	-	-	\$93.00	-	-
On/Off Switch Assembly	4040SE-3436	-	-	-	\$93.00	-	-
Flat Box w/Label	4040SE-Flat Box	-	-	-	\$9.00	-	-
Instruction Sheet	4040SE-Instruction Sheet	-	-	-	\$7.00	-	-
Box and Instruction Sheet	4040SE-Rebox Kit	-	-	-	\$9.00	-	-

2310ME Series	Specify				Price		
	Part number	Finish	Handing	Voltage	Powder coat	652 plated	Other plated
☞ Std Cylinder Assembly	2314ME-3071	.[Finish]	.[Handing]	.[24, 120]	\$1,332.00	\$1,516.00	\$1,590.00
☞ B80 Cylinder Assembly	2314ME-3071B80	.[Finish]	.[Handing]	.[24, 120]	\$1,423.00	\$1,610.00	\$1,683.00
☞ B140 Cylinder Assembly	2314ME-3071B140	.[Finish]	.[Handing]	.[24, 120]	\$1,423.00	\$1,610.00	\$1,683.00
☞ Cylinder Only	2314ME-3971	.[Finish]	.[Handing]	.[24, 120]	\$1,219.00	-	-
☞ B80 Cylinder Only	2314ME-3971B80	.[Finish]	.[Handing]	.[24, 120]	\$1,332.00	-	-
☞ B140 Cylinder Only	2314ME-3971B140	.[Finish]	.[Handing]	.[24, 120]	\$1,332.00	-	-
☞ Standard Arm	2310ME-3077T	.[Finish]	.[Handing]	.[24, 120]	\$144.00	\$414.00	\$451.00
Standard Track	2310ME-3038	.[Finish]	-	-	\$93.00	-	-
Screw Pack (incl -3034)	2310ME-WMS	.[Finish]	-	-	\$63.00	\$86.00	\$105.00
Screw Pack (incl -3034)	2310ME-TORX	.[Finish]	-	-	\$79.00	\$102.00	\$120.00

☞ Handed

2310ME Series	Specify				Price		
	Part number	Finish	Handing	Voltage	Powder coat	652 plated	Other plated
Finish Plate	2310ME-11	.[Finish]	-	-	\$37.00	\$93.00	\$130.00
Short Finish Plate	2310ME-12	.[Finish]	-	-	\$37.00	\$93.00	\$130.00
Cover Screw	2310ME-31	-	-	-	\$7.00	-	-
Arm Screw	2310ME-159	-	-	-	\$7.00	-	-
Wiring Cover	2310ME-172	-	-	-	\$14.00	-	-
Fire Shield	2310ME-420	-	-	-	\$81.00	-	-
Roller Lock Screw	2310ME-425	-	-	-	\$9.00	-	-
Track Roller	2310ME-3034	-	-	-	\$37.00	-	-
Transformer	2310ME-3210	-	-	-	\$93.00	-	-
Input Jumper	2310ME-3431	-	-	-	\$10.00	-	-
ME Switch Assembly	2310ME-3351	-	-	.[24, 120]	\$112.00	-	-
Flat Box w/Label	2310ME-Flat Box	-	-	-	\$9.00	-	-
Instruction Sheet	2310ME-Instruction Sheet	-	-	-	\$7.00	-	-
Box and Instruction Sheet	2310ME-Rebox Kit	-	-	-	\$9.00	-	-

4310ME Series	Specify				Price		
	Part number	Finish	Handing	Voltage	Powder coat	652 plated	Other plated
☞ Std Cylinder Assembly	4314ME-3071	.[Finish]	.[Handing]	.[24, 120]	\$1,257.00	-	-
☞ B80 Cylinder Assembly	4314ME-3071B80	.[Finish]	.[Handing]	.[24, 120]	\$1,361.00	-	-
☞ B140 Cylinder Assembly	4314ME-3071B140	.[Finish]	.[Handing]	.[24, 120]	\$1,361.00	-	-
☞ Cylinder Only	4314ME-3971	.[Finish]	.[Handing]	.[24, 120]	\$1,176.00	-	-
☞ B80 Cylinder Only	4314ME-3971B80	.[Finish]	.[Handing]	.[24, 120]	\$1,232.00	-	-
☞ B140 Cylinder Only	4314ME-3971B140	.[Finish]	.[Handing]	.[24, 120]	\$1,232.00	-	-
☞ Swing Free Arm	4310ME-3077SF	.[Finish]	.[Handing]	-	\$144.00	\$414.00	\$451.00
☞ DE Arm	4310ME-3077DE	.[Finish]	.[Handing]	-	\$204.00	\$474.00	\$511.00
Standard Track	4310ME-3038	.[Finish]	-	-	\$93.00	-	-
☞ Metal Cover	4310ME-72MC	.[Finish]	.[Handing]	-	\$112.00	\$328.00	\$607.00
Screw Pack (incl -3034)	4310ME-WMS	.[Finish]	-	-	\$63.00	\$86.00	\$105.00
Screw Pack (incl -3034)	4310ME-TBWMS	.[Finish]	-	-	\$63.00	\$86.00	\$105.00
Screw Pack (incl -3034)	4310ME-TORX	.[Finish]	-	-	\$79.00	\$102.00	\$120.00
Screw Pack (incl -3034)	4310ME-TBTRX	.[Finish]	-	-	\$79.00	\$102.00	\$120.00
Plate	4310ME-18	.[Finish]	-	-	\$235.00	-	-
Cover Screw	4310ME-31	-	-	-	\$7.00	-	-
Spacer	4310ME-61	-	-	-	\$19.00	-	-
End Cap	4310ME-73	-	-	-	\$14.00	-	-
Arm Screw	4310ME-83	-	-	-	\$7.00	-	-
Plug	4310ME-141-2	-	-	-	\$7.00	-	-
Arm Screw	4310ME-159	-	-	-	\$7.00	-	-
Roller Lock Screw	4310ME-425	-	-	-	\$9.00	-	-
Track Roller	4310ME-3034	-	-	-	\$37.00	-	-
Transformer	4310ME-3210	-	-	-	\$93.00	-	-
ME Switch Assembly	4310ME-3351	-	-	.[24, 120]	\$204.00	-	-
ME Wire Harness	4310ME-3354	-	-	-	\$19.00	-	-

☞ Handed

PARTS AND ACCESSORIES

Powder coat

689	Aluminum (AL)
690	Statuary Bronze (STAT)
691	Light Bronze (LTBRZ)
693	Black (GLBLK)
695	Dark Bronze (DKBRZ)
696	Brass (BRASS)

Plated

616	Satin Bronze, Blackened (US11)
632	Brass (US3)
633	Satin Brass (US4)
639	Satin Bronze (US10)
646	Satin Nickel (US15)
651	Bright Chrome (US26)
652	Satin Chrome (US26D)

Anodized

628	Aluminum (ANCLR)
710	Dark Bronze (ANDKB)

Handing

RH	Right hand
LH	Left hand

4310ME Series	Specify				Price		
	Part number	Finish	Handing	Voltage	Powder coat	652 plated	Other plated
Input Harness	4310ME-3431	-	-	-	\$10.00	-	-
Flat Box w/Label	4310ME-Flat Box	-	-	-	\$9.00	-	-
Instruction Sheet	4310ME-Instruction Sheet	-	-	-	\$7.00	-	-
Box and Instruction Sheet	4310ME-Rebox Kit	-	-	-	\$9.00	-	-

4410ME Series	Specify				Price		
	Part number	Finish	Handing	Voltage	Powder coat	652 plated	Other plated
Std Cylinder Assembly	4414ME-3071	.[Finish]	.[Handing]	.[24, 120]	\$1,257.00	-	-
Std Cylinder Assembly w/18G	4414ME-3071/18G	.[Finish]	.[Handing]	.[24, 120]	\$1,257.00	-	-
B80 Cylinder Assembly	4414ME-3071B80	.[Finish]	.[Handing]	.[24, 120]	\$1,361.00	-	-
B80 Cylinder Assembly w/18G	4414ME-3071B80G	.[Finish]	.[Handing]	.[24, 120]	\$1,361.00	-	-
B140 Cylinder Assembly	4414ME-3071B140	.[Finish]	.[Handing]	.[24, 120]	\$1,361.00	-	-
B140 Cylinder Assembly w/18G	4414ME-3071B140G	.[Finish]	.[Handing]	.[24, 120]	\$1,361.00	-	-
Cylinder Only	4414ME-3971	.[Finish]	.[Handing]	.[24, 120]	\$1,176.00	-	-
B80 Cylinder Only	4414ME-3971B80	.[Finish]	.[Handing]	.[24, 120]	\$1,176.00	-	-
B140 Cylinder Only	4414ME-3971B140	.[Finish]	.[Handing]	.[24, 120]	\$1,176.00	-	-
Reg Arm	4410ME-3077	.[Finish]	-	-	\$149.00	\$422.00	\$459.00
Long Arm	4410ME-3077L	.[Finish]	-	-	\$154.00	\$428.00	\$464.00
Metal Cover	4410ME-72MC	.[Finish]	.[Handing]	-	\$112.00	\$328.00	\$607.00
Screw Pack	4410ME-WMS	.[Finish]	-	-	\$31.00	\$55.00	\$73.00
Screw Pack	4410ME-TBWMS	.[Finish]	-	-	\$31.00	\$55.00	\$73.00
Screw Pack	4410ME-TORX	.[Finish]	-	-	\$49.00	\$71.00	\$90.00
Screw Pack	4410ME-TBTRX	.[Finish]	-	-	\$49.00	\$71.00	\$90.00
Plate	4410ME-18	.[Finish]	-	-	\$235.00	-	-
Mounting Plate	4410ME-18G	.[Finish]	-	-	\$235.00	-	-
Cover Screw	4410ME-31	-	-	-	\$7.00	-	-
Arm and Forearm	4410ME-77	.[Finish]	-	-	\$149.00	\$321.00	\$360.00
Long Arm and Forearm	4410ME-77L	.[Finish]	-	-	\$149.00	\$321.00	\$360.00
Rod and Shoe	4410ME-79	.[Finish]	-	-	\$37.00	\$93.00	\$130.00
ME Long Rod	4410ME-79L	.[Finish]	-	-	\$55.00	\$130.00	\$166.00
H Arm Screw	4410ME-83H	-	-	-	\$7.00	-	-
Arm Screw	4410ME-159	-	-	-	\$7.00	-	-
Transformer	4410ME-3210	-	-	-	\$93.00	-	-
ME Switch Assembly	4410ME-3351	-	-	.[24, 120]	\$204.00	-	-
ME Wire Harness	4410ME-3354	-	-	-	\$19.00	-	-
Input Harness	4410ME-3431	-	-	-	\$10.00	-	-
Flat Box w/Label	4410ME-Flat Box	-	-	-	\$9.00	-	-

Handed

4410ME Series	Specify				Price		
	Part number	Finish	Handing	Voltage	Powder coat	652 plated	Other plated
Instruction Sheet	4410ME-Instruction Sheet	-	-	-	\$7.00	-	-
Box and Instruction Sheet	4410ME-Rebox Kit	-	-	-	\$9.00	-	-

4310HSA Series	Specify				Price		
	Part number	Finish	Handing		Powder coat	652 plated	Other plated
☞ Std Cylinder Assembly	4311HSA-3071	.[Finish]	-		\$1,361.00	-	-
☞ Cylinder Only	4311HSA-3971	-	.[Handing]		\$1,232.00	-	-
☞ Standard Arm	4310HSA-3077T	.[Finish]	.[Handing]		\$144.00	\$414.00	\$451.00
☞ DE Arm	4310HSA-3077DE	.[Finish]	.[Handing]		\$204.00	\$474.00	\$511.00
Standard Track	4310HSA-3038	.[Finish]	-		\$93.00	-	-
☞ Metal Cover	4310HSA-72MC	.[Finish]	.[Handing]		\$112.00	\$328.00	\$607.00
Screw Pack (incl -3034)	4310HSA-WMS	.[Finish]	-		\$63.00	\$86.00	\$105.00
Screw Pack (incl -3034)	4310HSA-TBWS	.[Finish]	-		\$63.00	\$86.00	\$105.00
Screw Pack (incl -3034)	4310HSA-TORX	.[Finish]	-		\$79.00	\$102.00	\$120.00
Screw Pack (incl -3034)	4310HSA-TBTRX	.[Finish]	-		\$79.00	\$102.00	\$120.00
☞ Plate	4310HSA-18	.[Finish]	.[Handing]		\$235.00	-	-
Cover Screw	4310HSA-31	-	-		\$7.00	-	-
Spacer	4310HSA-61	-	-		\$19.00	-	-
End Cap	4310HSA-73	-	-		\$14.00	-	-
Arm Screw	4310HSA-83	-	-		\$7.00	-	-
Plug	4310HSA-141-2	-	-		\$7.00	-	-
Arm Screw	4310HSA-159	-	-		\$7.00	-	-
Roller Lock Screw	4310HSA-425	-	-		\$9.00	-	-
Track Roller	4310HSA-3034	-	-		\$37.00	-	-
Transformer	4310HSA-3210	-	-		\$93.00	-	-
Scanner Module	4310HSA-3428	-	-		\$204.00	-	-
HSA Solenoid Harness	4310HSA-3430	-	-		\$11.00	-	-
Input Harness	4310HSA-3431	-	-		\$10.00	-	-
HSA PCB Module	4310HSA-3448	-	-		\$31.00	-	-
Flat Box w/Label	4310HSA-Flat Box	-	-		\$9.00	-	-
Instruction Sheet	4310HSA-Instruction Sheet	-	-		\$7.00	-	-
Box and Instruction Sheet	4310HSA-Rebox Kit	-	-		\$9.00	-	-

4410HSA Series	Specify				Price		
	Part number	Finish	Handing		Powder coat	652 plated	Other plated
☞ Std Cylinder Assembly	4414HSA-3071	.[Finish]	.[Handing]		\$1,361.00	-	-
☞ Std Cylinder Assembly w/18G	4414HSA-3071/18G	.[Finish]	.[Handing]		\$1,361.00	-	-
☞ Cylinder Only	4414HSA-3971	.[Finish]	.[Handing]		\$1,176.00	-	-
☞ Reg Arm	4410HSA-3077	.[Finish]	-		\$149.00	\$422.00	\$459.00
☞ Long Arm	4410HSA-3077L	.[Finish]	-		\$154.00	\$428.00	\$464.00
☞ Metal Cover	4410HSA-72MC	.[Finish]	.[Handing]		\$112.00	\$328.00	\$607.00
Screw Pack	4410HSA-WMS	.[Finish]	-		\$31.00	\$55.00	\$73.00
Screw Pack	4410HSA-TBWS	.[Finish]	-		\$31.00	\$55.00	\$73.00

☞ Handed

PARTS AND ACCESSORIES

Powder coat

689	Aluminum (AL)
690	Statuary Bronze (STAT)
691	Light Bronze (LTBRZ)
693	Black (GLBLK)
695	Dark Bronze (DKBRZ)
696	Brass (BRASS)

Plated

616	Satin Bronze, Blackened (US11)
632	Brass (US3)
633	Satin Brass (US4)
639	Satin Bronze (US10)
646	Satin Nickel (US15)
651	Bright Chrome (US26)
652	Satin Chrome (US26D)

Anodized

628	Aluminum (ANCLR)
710	Dark Bronze (ANDKB)

Handing

RH	Right hand
LH	Left hand

4410HSA Series	Specify			Price		
	Part number	Finish	Handing	Powder coat	652 plated	Other plated
Screw Pack	4410HSA-TORX	.[Finish]	-	\$49.00	\$71.00	\$90.00
Screw Pack	4410HSA-TBTRX	.[Finish]	-	\$49.00	\$71.00	\$90.00
🔓 Plate	4410HSA-18	.[Finish]	.[Handing]	\$235.00	-	-
🔓 Mounting Plate	4410HSA-18G	.[Finish]	.[Handing]	\$235.00	-	-
Cover Screw	4410HSA-31	-	-	\$7.00	-	-
Arm and Forearm	4410HSA-77	-	-	\$149.00	-	-
Long Arm and Forearm	4410HSA-77L	-	-	\$149.00	-	-
Rod and Shoe	4410HSA-79	.[Finish]	-	\$37.00	\$93.00	\$130.00
Long Rod and Shoe	4410HSA-79L	.[Finish]	-	\$55.00	\$130.00	\$166.00
H Arm Screw	4410HSA-83H	-	-	\$7.00	-	-
Arm Screw	4410HSA-159	-	-	\$7.00	-	-
Transformer	4410HSA-3210	-	-	\$93.00	-	-
Scanner Module	4410HSA-3428	-	-	\$204.00	-	-
HSA Solenoid Harness	4410HSA-3430	-	-	\$11.00	-	-
Input Harness	4410HSA-3431	-	-	\$10.00	-	-
HSA PCB Module	4410HSA-3448	-	-	\$31.00	-	-
Flat Box w/Label	4410HSA-Flat Box	-	-	\$9.00	-	-
Instruction Sheet	4410HSA-Instruction Sheet	-	-	\$7.00	-	-
Box and Instruction Sheet	4410HSA-Rebox Kit	-	-	\$9.00	-	-

4040SEH Series	Specify				Price		
	Part number	Finish	Handing	Voltage	Powder coat	652 plated	Other plated
SEH Arm	4040SEH-3077SEH	.[Finish]	-	-	\$224.00	\$495.00	\$531.00
Standard SEH Track	4040SEH-3038	.[Finish]	-	.[24, 120]	\$501.00	-	-
Cover Plate	4040SEH-59A	.[Finish]	-	-	\$9.00	-	-
Arm and Tube	4040SEH-78SEH	.[Finish]	-	-	\$174.00	\$298.00	\$483.00
Rod	4040SEH-82SEH	.[Finish]	-	-	\$118.00	\$291.00	\$428.00
Arm Screw	4040SEH-83SEH	-	-	-	\$7.00	-	-
Track Roller and Slider	4040SEH-3034SEH	-	-	-	\$43.00	-	-

🔓 Handed

2210 SERIES

The concealed 2210 Series, heavy duty, high security track closer features complete concealment with special components to minimize tampering and vandalism. Forged steel, single lever arm and heavy steel mounting plate are designed for correctional, vandal prone, institutional, and other high traffic applications. A choice of finishes and cylinder functions meet correctional and vandal resistant requirements.

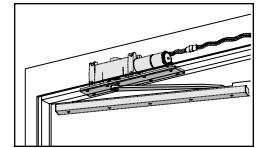

622	689	690	691	693	695	696	652	616	632	633	639	646	651
MTBLK	AL	STAT	LTBRZ	GLBLK	DKBRZ	BRASS	US26D	US11	US3	US4	US10	US15	US26

ACN for these commonly ordered products	PRICE BASED ON FINISH				
	POWDER COAT		PLATED		
	622	689	652	616	632
	690	691		633	639
	693	695		646	651
	696				

DEFAULT CONFIGURATIONS			
Model	Finish	Handing	
☞ [2213, 2214 or 2215]	[]	[RH, LH]	\$1,170.00 \$1,802.00 \$1,987.00
☞ [2213, 2214 or 2215]DPS	[]	[RH, LH]	\$1,306.00 \$1,938.00 \$2,124.00

DEFAULT AND COMMON CONFIGURATIONS

Pricing includes default options shown below unless otherwise specified. Specification rules, additional options and pricing adders are shown in the tables below.

Cylinder
Cast Iron Cylinder Assembly (CYL)

Arm type
Standard Security Arm (STDTRKSECARM)

Track type
Standard Security Track (STDSECTRK)

Screw package
Torx Machine Screws (TORX)

BAA Compliant
See the [Allegion Buy America/ Buy American and Trade Agreement Acts \(BAA and TAA\) Compliance Guide](#) for full details

SPECIFICATION RULES, ADDITIONAL OPTIONS AND PRICING ADDERS

Order of attributes when placing an order for a non-standard configuration. See parts section for individual parts pricing. Attributes show in CAPS are required. Other attributes are required only if you are deviating from the product's default.

MODEL . CYLINDER . FINISH . Special rust inhibitor . HANDING . Screw package

Cylinder	Specify	Price adder
☞ Cast iron cylinder assembly (CYL) - Default	-	-
☞ Advanced Variable Back Check	CYLAVB	\$31.00
Custom powder coat finishes	Specify	Price adder
Apply price adder to powder coat price		
Custom Power Coat Finish	RAL []	\$50.00
Brite Metallic Powder Coat	MTLPC	\$73.00
Special rust inhibiting primer	Specify	Price adder
Special Rust Inhibitor for Powder Coat Finishes (excludes DPS)	SRI	\$50.00

☞ Handing required

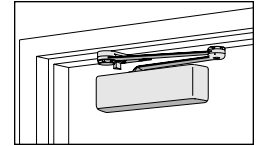

4210 SERIES 

The 4210 Smoothee® Series is a heavy duty, high security closer with special components to minimize tampering and vandalism. Forged steel parallel arms and heavy gauge metal security covers are designed for correctional, vandal prone, institutional and other high traffic applications. A choice of finishes and cylinder functions meet correctional and vandal resistant requirements.



622	689	690	691	693	695	696	652	616	632	633	639	646	651
MTBLK	AL	STAT	LTBRZ	GLBLK	DKBRZ	BRASS	US26D	US11	US3	US4	US10	US15	US26

ACN for these commonly ordered products	PRICE BASED ON FINISH				
	POWDER COAT		PLATED		
	622	689	652	616	632
	690	691		633	639
	693	695		646	651
	696				

DEFAULT CONFIGURATIONS					
Model	Arm	Finish	Handing		
 [4211 or 4216]	EDA	[Finish]	[RH, LH]	\$707.00	\$1,196.00
 [4211 or 4216]	CUSH	[Finish]	[RH, LH]	\$744.00	\$1,234.00
 [4211 or 4216]	HCUSH	[Finish]	[RH, LH]	\$830.00	\$1,320.00

Note: 4210 Series is available as 4211 (adjustable 1-5) or 4216 (size 6 only - not for ADA required applications).

DEFAULT AND COMMON CONFIGURATIONS

Pricing includes default options shown below unless otherwise specified. Specification rules, additional options and pricing adders are shown in the tables below.

Cylinder
Cast Iron Cylinder Assembly (CYL)

Cover
Metal Cover



Screw package
Torx Machine Screws (TORX)

BAA Compliant
See the [Allegion Buy America/ Buy American and Trade Agreement Acts \(BAA and TAA\) Compliance Guide](#) for full details

SPECIFICATION RULES, ADDITIONAL OPTIONS AND PRICING ADDERS

Order of attributes when placing an order for a non-standard configuration. See parts section for individual parts pricing. Attributes show in CAPS are required. Other attributes are required only if you are deviating from the product's default.

MODEL . Cylinder . ARM TYPE . FINISH . Special rust inhibitor . HANDING . Screw package . Door thickness

Cylinder	Specify	Price adder
 Cast iron cylinder assembly (CYL) - Default	-	-
 Advanced Variable Back Check	CYLAVB	\$30.00
 Delay Action Cylinder - 4211 only	CYLDEL	\$55.00
Custom powder coat finishes	Specify	Price adder
Apply price adder to powder coat price		
Custom Power Coat Finish	RAL []	\$50.00
Brite Metallic Powder Coat	MTLPC	\$73.00
Special rust inhibiting primer	Specify	Price adder
Special Rust Inhibitor for Powder Coat Finishes	SRI	\$50.00
Screw package	Specify	Price adder
Torx Machine Screws (TORX) - Default	-	-
Through Bolt and Torx Machine Screws	TBTRX	-

Door thickness	Specify
Specify if door thickness is different than 1-3/4" when choosing a through bolt screw pack	[]

 Handing required

 Indicates products that have EPD documentation available and meet LEED v4.

4210T SERIES 

The 4210T Smoothee Series is a heavy duty, high security track closer with special components to minimize tampering and vandalism. Forged steel arms and heavy gauge metal security covers are designed for correctional, vandal prone, institutional and other high traffic interior applications. A choice of finishes and cylinder functions meet correctional and vandal resistant requirements.

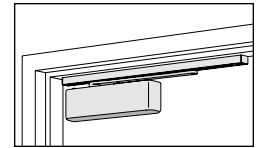

622	689	690	691	693	695	696	652	616	632	633	639	646	651
MTBLK	AL	STAT	LTBRZ	GLBLK	DKBRZ	BRASS	US26D	US11	US3	US4	US10	US15	US26

ACN for these commonly ordered products	PRICE BASED ON FINISH				
	POWDER COAT		PLATED		
	622	689	652	616	632
690	691	633		639	
693	695	646		651	
696					

DEFAULT CONFIGURATIONS			
Model	Finish	Handing	
 [4211, 4213 or 4214]T	[Finish]	[RH, LH]	
			\$844.00 \$1,334.00 \$1,432.00

DEFAULT AND COMMON CONFIGURATIONS

Pricing includes default options shown below unless otherwise specified. Specification rules, additional options and pricing adders are shown in the tables below.

Cylinder
Cast Iron Cylinder Assembly (CYL)

Arm type
Standard Security Arm (STDTRKSECARM)

Track type
Standard Security Track (STDSECTRK)

Cover
Metal Cover



Screw package
Torx Machine Screws (TORX)

BAA Compliant
See the [Allegion Buy America/ Buy American and Trade Agreement Acts \(BAA and TAA\) Compliance Guide](#) for full details

SPECIFICATION RULES, ADDITIONAL OPTIONS AND PRICING ADDERS

Order of attributes when placing an order for a non-standard configuration. See parts section for individual parts pricing. Attributes show in CAPS are required. Other attributes are required only if you are deviating from the product's default.

MODEL . Cylinder . FINISH . Special rust inhibitor . HANDING . Screw package . Door thickness

Cylinder	Specify	Price adder
 Cast iron cylinder assembly (CYL) - Default	-	-
 Advanced Variable Back Check	CYLABV	\$30.00
Custom powder coat finishes	Specify	Price adder
Apply price adder to powder coat price		
Custom Power Coat Finish	RAL []	\$50.00
Brite Metallic Powder Coat	MTLPC	\$73.00
Special rust inhibiting primer	Specify	Price adder
Special Rust Inhibitor for Powder Coat Finishes	SRI	\$50.00
Screw package	Specify	Price adder
Torx Machine Screws (TORX) - Default	-	-
Through Bolt and Torx Machine Screws	TBTRX	-

Door thickness	Specify
Specify if door thickness is different than 1-3/4" when choosing a through bolt screw pack	[]

 Handing required

 Indicates products that have EPD documentation available and meet LEED v4.

4510 SERIES 

The 4510 Smoothee Series is a heavy duty, high security closer with special components to minimize tampering and vandalism. Forged steel double lever arms and heavy gauge metal security covers are designed for correctional, vandal prone, institutional and other high traffic applications. A choice of finishes and cylinder functions meet correctional and vandal resistant requirements.

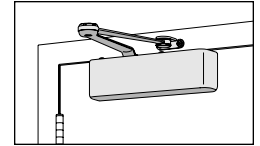

622	689	690	691	693	695	696	652	616	632	633	639	646	651
MTBLK	AL	STAT	LTBRZ	GLBLK	DKBRZ	BRASS	US26D	US11	US3	US4	US10	US15	US26

ACN for these commonly ordered products	PRICE BASED ON FINISH				
	POWDER COAT		PLATED		
	622	689	652	616	632
	690	691		633	639
	693	695		646	651
	696				

DEFAULT CONFIGURATIONS				
Model	Finish	Handing		
 [4511 or 4516]	[Finish]	[RH, LH]	\$707.00	\$1,196.00
				\$1,295.00

Note: 4510 Series is available as 4511 (adjustable 1-5) or 4516 (size 6 only - not for ADA required applications).

DEFAULT AND COMMON CONFIGURATIONS

Pricing includes default options shown below unless otherwise specified. Specification rules, additional options and pricing adders are shown in the tables below.

Cylinder
Cast Iron Cylinder Assembly (CYL)

Arm type
Extra Duty Arm (EDA)

Cover
Metal Cover



Screw package
Torx Machine Screws (TORX)

BAA Compliant
See the [Allegion Buy America/ Buy American and Trade Agreement Acts \(BAA and TAA\) Compliance Guide](#) for full details

SPECIFICATION RULES, ADDITIONAL OPTIONS AND PRICING ADDERS

Order of attributes when placing an order for a non-standard configuration. See parts section for individual parts pricing. Attributes show in CAPS are required. Other attributes are required only if you are deviating from the product's default.

MODEL . Cylinder . FINISH . Special rust inhibitor . HANDING . Screw package . Door thickness

Cylinder	Specify	Price adder
 Cast iron cylinder assembly (CYL) - Default	-	-
 Advanced Variable Back Check	CYLAVB	\$30.00
 Delay Action Cylinder - 4511 only	CYLDEL	\$55.00
Custom powder coat finishes	Specify	Price adder
Apply price adder to powder coat price		
Custom Power Coat Finish	RAL []	\$50.00
Brite Metallic Powder Coat	MTLPC	\$73.00
Special rust inhibiting primer	Specify	Price adder
Special Rust Inhibitor for Powder Coat Finishes	SRI	\$50.00
Screw package	Specify	Price adder
Torx Machine Screws (TORX) - Default	-	-
Through Bolt and Torx Machine Screws	TBTRX	-

Door thickness	Specify
Specify if door thickness is different than 1-3/4" when choosing a through bolt screw pack	[]

 Handing required

 Indicates products that have EPD documentation available and meet LEED v4.

4510T SERIES 

The 4510T Smoothee Series is a heavy duty, high security track closer with special components to minimize tampering and vandalism. Forged steel single lever arm and heavy gauge metal security cover are designed for correctional, vandal prone, institutional and other high traffic interior applications. A choice of finishes and cylinder functions meet correctional and vandal resistant requirements.

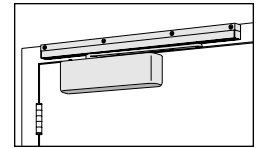

622	689	690	691	693	695	696	652	616	632	633	639	646	651
MTBLK	AL	STAT	LTBRZ	GLBLK	DKBRZ	BRASS	US26D	US11	US3	US4	US10	US15	US26

ACN for these commonly ordered products	PRICE BASED ON FINISH				
	POWDER COAT		PLATED		
	622	689	652	616	632
	690	691		633	639
	693	695		646	651
	696				

DEFAULT CONFIGURATIONS						
Model	Finish	Handing				
 [4511, 4513 or 4514]T	[Finish]	[RH, LH]	\$844.00	\$1,334.00	\$1,432.00	

DEFAULT AND COMMON CONFIGURATIONS

Pricing includes default options shown below unless otherwise specified. Specification rules, additional options and pricing adders are shown in the tables below.

Cylinder
Cast Iron Cylinder Assembly (CYL)

Arm type
Standard Security Arm (STDTRKSECARM)

Track type
Standard Security Track (STDSECTRK)

Cover
Metal Cover

Screw package
Torx Machine Screws (TORX)

BAA Compliant
See the [Allegion Buy America/ Buy American and Trade Agreement Acts \(BAA and TAA\) Compliance Guide](#) for full details

SPECIFICATION RULES, ADDITIONAL OPTIONS AND PRICING ADDERS

Order of attributes when placing an order for a non-standard configuration. See parts section for individual parts pricing. Attributes show in CAPS are required. Other attributes are required only if you are deviating from the product's default.

MODEL . Cylinder . FINISH . Special rust inhibitor . HANDING . Screw package . Door thickness

Cylinder	Specify	Price adder
Cast iron cylinder assembly (CYL) - Default	-	-
Advanced Variable Back Check	CYLABV	\$30.00
Custom powder coat finishes	Specify	Price adder
Apply price adder to powder coat price		
Custom Power Coat Finish	RAL []	\$50.00
Brite Metallic Powder Coat	MTLPC	\$73.00
Special rust inhibiting primer	Specify	Price adder
Special Rust Inhibitor for Powder Coat Finishes	SRI	\$50.00
Screw package	Specify	Price adder
Torx Machine Screws (TORX) - Default	-	-
Through Bolt and Torx Machine Screws	TBTRX	-

Door thickness	Specify
Specify if door thickness is different than 1-3/4" when choosing a through bolt screw pack	[]

 Handing required

 Indicates products that have EPD documentation available and meet LEED v4.

PARTS AND ACCESSORIES

Powder coat

622	Matte Black (MTBLK)
689	Aluminum (AL)
690	Statuary Bronze (STAT)
691	Light Bronze (LTBRZ)
693	Black (GLBLK)
695	Dark Bronze (DKBRZ)
696	Brass (BRASS)

Plated

616	Satin Bronze, Blackened (US11)
632	Brass (US3)
633	Satin Brass (US4)
639	Satin Bronze (US10)
646	Satin Nickel (US15)
651	Bright Chrome (US26)
652	Satin Chrome (US26D)

Anodized

628	Aluminum (ANCLR)
710	Dark Bronze (ANDKB)

Handing

RH	Right hand
LH	Left hand

2210 Series	Specify			Price		
	Part number	Finish	Handing	Powder coat	652 plated	Other plated
Std Cylinder Assembly	2213(4,5)-3071	.[Finish]	.[Handing]	\$928.00	\$1,287.00	\$1,435.00
AVB Cylinder Assembly	2213(4,5)-3071AVB	.[Finish]	.[Handing]	\$959.00	\$1,318.00	\$1,466.00
Standard Arm	2210-3077T	.[Finish]	.[Handing]	\$149.00	\$422.00	\$459.00
Standard Track	2210-3038	.[Finish]	-	\$93.00	-	-
Screw Pack	2210-TORX	.[Finish]	-	\$60.00	\$84.00	\$102.00
Finish Plate	2210-11	.[Finish]	-	\$37.00	\$93.00	\$130.00
Short Finish Plate	2210-12	.[Finish]	-	\$37.00	\$93.00	\$130.00
Cover Screw	2210-31	.[Finish]	-	\$7.00	-	-
Arm Screw	2210-159	.[Finish]	-	\$7.00	-	-
Track Roller	2210-3034	-	-	\$37.00	-	-
Flat Box w/Label	2210-Flat Box	-	-	\$9.00	-	-
Instruction Sheet	2210-Instruction Sheet	-	-	\$7.00	-	-
Box and Instruction Sheet	2210-Rebox Kit	-	-	\$9.00	-	-

2210DPS Series	Specify			Price		
	Part number	Finish	Handing	Powder coat	652 plated	Other plated
Std Cylinder Assembly	2213(4,5)DPS-3071	.[Finish]	.[Handing]	\$1,064.00	\$1,423.00	\$1,572.00
AVB Cylinder Assembly	2213(4,5)DPS-3071AVB	.[Finish]	.[Handing]	\$1,095.00	\$1,454.00	\$1,603.00
Standard Arm	2210DPS-3077T	.[Finish]	.[Handing]	\$149.00	\$422.00	\$459.00
Standard Track	2210DPS-3038	.[Finish]	-	\$93.00	-	-
Screw Pack	2210DPS-TORX	.[Finish]	-	\$60.00	\$84.00	\$102.00
Finish Plate	2210DPS-11	.[Finish]	-	\$37.00	\$93.00	\$130.00
Short Finish Plate	2210DPS-12	.[Finish]	-	\$37.00	\$93.00	\$130.00
Cover Screw	2210DPS-31	.[Finish]	-	\$7.00	-	-
Arm Screw	2210DPS-159	.[Finish]	-	\$7.00	-	-
DPS Test Kit	2210DPS-493	-	-	\$93.00	-	-
Track Roller	2210DPS-3034	-	-	\$37.00	-	-
Wire Harness	2210DPS-3340	-	-	\$93.00	-	-
Flat Box w/Label	2210DPS-Flat Box	-	-	\$9.00	-	-
Instruction Sheet	2210DPS-Instruction Sheet	-	-	\$7.00	-	-
Box and Instruction Sheet	2210DPS-Rebox Kit	-	-	\$9.00	-	-

Handed

4210 Series	Specify			Price		
	Part number	Finish	Handing	Powder coat	652 plated	Other plated
☞ Std Cylinder Assembly	4211(6)-3071	.[Finish]	.[Handing]	\$459.00	-	-
☞ AVB Cylinder Assembly	4211(6)-3071AVB	.[Finish]	.[Handing]	\$489.00	-	-
☞ Del Action Cylinder Assembly	4211-3071DEL	.[Finish]	.[Handing]	\$514.00	-	-
EDA Arm	4210-3077EDA	.[Finish]	-	\$198.00	\$470.00	\$508.00
Cush Arm	4210-3077CNS	.[Finish]	-	\$235.00	\$508.00	\$545.00
H Cush Arm	4210-3049CNS	.[Finish]	-	\$321.00	\$594.00	\$631.00
☞ Metal Cover	4210-72MC	.[Finish]	.[Handing]	\$50.00	\$267.00	\$328.00
Screw Pack	4210-TORX	.[Finish]	-	\$60.00	\$84.00	\$102.00
Screw Pack	4210-TBTRX	.[Finish]	-	\$60.00	\$84.00	\$102.00
Plate	4210-18	.[Finish]	-	\$98.00	\$347.00	\$383.00
Cush Shoe Support	4210-30	.[Finish]	-	\$26.00	\$81.00	\$118.00
Cover Screw	4210-31	-	-	\$7.00	-	-
Spacer	4210-61	.[Finish]	-	\$31.00	\$86.00	\$123.00
Arm Screw	4210-159	.[Finish]	-	\$7.00	-	-
Spacer	4210-201	-	-	\$9.00	-	-
Panel Adapter	4210-419	.[Finish]	-	\$81.00	\$186.00	\$224.00
Flat Box w/Label	4210-Flat Box	-	-	\$9.00	-	-
Instruction Sheet	4210-Instruction Sheet	-	-	\$7.00	-	-
Box and Instruction Sheet	4210-Rebox Kit	-	-	\$9.00	-	-

4210T Series	Specify			Price		
	Part number	Finish	Handing	Powder coat	652 plated	Other plated
☞ Std Cylinder Assembly	4211(3,4)T-3071	.[Finish]	.[Handing]	\$459.00	-	-
☞ AVB Cylinder Assembly	4211(3,4) T-3071AVB	.[Finish]	.[Handing]	\$489.00	-	-
☞ Standard Arm	4210T-3077T	.[Finish]	.[Handing]	\$149.00	\$422.00	\$459.00
Standard Track	4210T-3038	.[Finish]	-	\$186.00	-	-
☞ Metal Cover	4210T-72MC	.[Finish]	.[Handing]	\$50.00	\$267.00	\$328.00
Screw Pack	4210T-TORX	.[Finish]	-	\$60.00	\$84.00	\$102.00
Screw Pack	4210T-TBTRX	.[Finish]	-	\$60.00	\$84.00	\$102.00
Plate	4210T-18	.[Finish]	-	\$98.00	\$347.00	\$383.00
Cover Screw	4210T-31	.[Finish]	-	\$7.00	-	-
Arm Screw	4210T-159	.[Finish]	-	\$7.00	-	-
Track Roller	4210T-3034	-	-	\$37.00	-	-
Flat Box w/Label	4210T-Flat Box	-	-	\$9.00	-	-
Instruction Sheet	4210T-Instruction Sheet	-	-	\$7.00	-	-
Box and Instruction Sheet	4210T-Rebox Kit	-	-	\$9.00	-	-

☞ Handed

PARTS AND ACCESSORIES

Powder coat

622	Matte Black (MTBLK)
689	Aluminum (AL)
690	Statuary Bronze (STAT)
691	Light Bronze (LTBRZ)
693	Black (GLBLK)
695	Dark Bronze (DKBRZ)
696	Brass (BRASS)

Plated

616	Satin Bronze, Blackened (US11)
632	Brass (US3)
633	Satin Brass (US4)
639	Satin Bronze (US10)
646	Satin Nickel (US15)
651	Bright Chrome (US26)
652	Satin Chrome (US26D)

Anodized

628	Aluminum (ANCLR)
710	Dark Bronze (ANDKB)

Handing

RH	Right hand
LH	Left hand

4510 Series	Specify			Price		
	Part number	Finish	Handing	Powder coat	652 plated	Other plated
Std Cylinder Assembly	4511(6)-3071	.[Finish]	.[Handing]	\$459.00	-	-
AVB Cylinder Assembly	4511(6)-3071AVB	.[Finish]	.[Handing]	\$489.00	-	-
Del Action Cylinder Assembly	4511-3071DEL	.[Finish]	.[Handing]	\$514.00	-	-
EDA Arm	4510-3077EDA	.[Finish]	-	\$198.00	\$470.00	\$508.00
Metal Cover	4510-72MC	.[Finish]	.[Handing]	\$50.00	\$267.00	\$328.00
Screw Pack	4510-TORX	.[Finish]	-	\$60.00	\$84.00	\$102.00
Screw Pack	4510-TBTRX	.[Finish]	-	\$60.00	\$84.00	\$102.00
Plate	4510-18	.[Finish]	-	\$98.00	\$347.00	\$383.00
Cover Screw	4510-31	.[Finish]	-	\$7.00	-	-
Arm Screw	4510-159	.[Finish]	-	\$7.00	-	-
Flat Box w/Label	4510-Flat Box	-	-	\$9.00	-	-
Instruction Sheet	4510-Instruction Sheet	-	-	\$7.00	-	-
Box and Instruction Sheet	4510-Rebox Kit	-	-	\$9.00	-	-

4510T Series	Specify			Price		
	Part number	Finish	Handing	Powder coat	652 plated	Other plated
Std Cylinder Assembly	4511(3,4)T-3071	.[Finish]	.[Handing]	\$459.00	-	-
AVB Cylinder Assembly	4511(3,4) T-3071AVB	.[Finish]	.[Handing]	\$489.00	-	-
Standard Arm	4510T-3077T	.[Finish]	.[Handing]	\$149.00	\$422.00	\$459.00
Standard Track	4510T-3038	.[Finish]	-	\$186.00	-	-
Metal Cover	4510T-72MC	.[Finish]	.[Handing]	\$50.00	\$267.00	\$328.00
Screw Pack	4510T-TORX	.[Finish]	-	\$60.00	\$84.00	\$102.00
Screw Pack	4510T-TBTRX	.[Finish]	-	\$60.00	\$84.00	\$102.00
Plate	4510T-18	.[Finish]	-	\$98.00	\$347.00	\$383.00
Cover Screw	4510T-31	.[Finish]	-	\$7.00	-	-
Arm Screw	4510T-159	.[Finish]	-	\$7.00	-	-
Track Roller	4510T-3034	-	-	\$37.00	-	-
Flat Box w/Label	4510T-Flat Box	-	-	\$9.00	-	-
Instruction Sheet	4510T-Instruction Sheet	-	-	\$7.00	-	-
Box and Instruction Sheet	4510T-Rebox Kit	-	-	\$9.00	-	-

Handed

2610 SERIES

The 2610 Auto Equalizer™ is LCN's pneumatically powered solution for concealed applications. This low-energy automatic operator is designed for primarily manual scenarios with occasional automatic actuation.

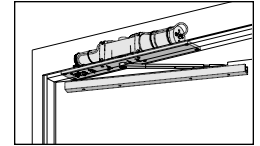

689	690	691	693	695	696	652	616	632	633	639	646	651
AL	STAT	LTBRZ	GLBLK	DKBRZ	BRASS	US26D	US11	US3	US4	US10	US15	US26

ACN for these commonly ordered products	PRICE BASED ON FINISH														
	POWDER COAT			PLATED											
	689	690	691	652	616	632	633								
	693	695	696				639	646	651						
DEFAULT CONFIGURATIONS															
Model . Finish . Handing															
👉 [2613 or 2614] . [Finish] . [RH, LH]															
<table border="1"> <tr> <td>\$2,830.00</td> <td>\$3,320.00</td> <td>\$3,635.00</td> </tr> </table>													\$2,830.00	\$3,320.00	\$3,635.00
\$2,830.00	\$3,320.00	\$3,635.00													
ADDITIONAL COMMON CONFIGURATIONS															
Model . Cylinder . Finish . Handing															
👉 [2613 or 2614] . DPS . [Finish] . [RH, LH]															
<table border="1"> <tr> <td>\$2,966.00</td> <td>\$3,455.00</td> <td>\$3,770.00</td> </tr> </table>													\$2,966.00	\$3,455.00	\$3,770.00
\$2,966.00	\$3,455.00	\$3,770.00													

DEFAULT AND COMMON CONFIGURATIONS

Pricing includes default options shown below unless otherwise specified. Specification rules, additional options and pricing adders are shown in the tables below.

Cylinder

Cast Iron Cylinder Assembly (CYL)

Arm type

Standard Arm (STDTRKARM)

Track type

Standard Track (STDTRK)

Cover

Metal Cover (MC)

Screw package

Wood and Machine Screws (WMS)

BAA Compliant

See the [Allegion Buy America/ Buy American and Trade Agreement Acts \(BAA and TAA\) Compliance Guide](#) for full details

! The 2610 requires a control box and air source to complete the system. It can be paired with a 7980 Series control box with a built-in compressor or a 7900 Series control box along with a third party compressor or building's air system.

[View LCN control boxes](#)

SPECIFICATION RULES, ADDITIONAL OPTIONS AND PRICING ADDERS

Order of attributes when placing an order for a non-standard configuration. See parts section for individual parts pricing. Attributes show in CAPS are required. Other attributes are required only if you are deviating from the product's default.

MODEL . Cylinder . FINISH . HANDING

Custom powder coat finishes	Specify	Price adder
Apply price adder to powder coat price		
Custom Power Coat Finish	RAL []	\$50.00
Brite Metallic Powder Coat	MTLPC	\$73.00

👉 Handing required

4810 SERIES

PNEUMATIC

The 4810 Auto Equalizer™ is LCN's pneumatically powered solution for top jamb, surface mount, pull side applications. This low-energy automatic operator is designed for primarily manual scenarios with occasional automatic actuation.

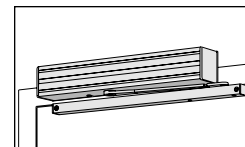

689	690	691	693	695	696	652	616	632	633	639	646	651		
AL	STAT	LTBRZ	GLBLK	DKBRZ	BRASS	US26D	US11	US3	US4	US10	US15	US26		
ACN for these commonly ordered products						PRICE BASED ON FINISH								
						POWDER COAT			PLATED					
						689	690	691	652	616	632	633		
						693	695	696		639	646	651		
DEFAULT CONFIGURATIONS														
Model . Finish														
4811 . [Finish]		\$2,780.00	\$3,269.00	\$3,585.00										

DEFAULT AND COMMON CONFIGURATIONS

Pricing includes default options shown below unless otherwise specified. Specification rules, additional options and pricing adders are shown in the tables below.

Cylinder
Cast Iron Cylinder Assembly (CYL)

Arm type
Standard Arm (STDTRKARM)

Track type
Standard Track (STDTRK)

Cover
Metal Cover (MC)

Screw package
Wood and Machine Screws (WMS)

BAA Compliant
See the [Allegion Buy America/ Buy American and Trade Agreement Acts \(BAA and TAA\) Compliance Guide](#) for full details

The 4810 requires a control box and air source to complete the system. It can be paired with a 7980 Series control box with a built-in compressor or a 7900 Series control box along with a third party compressor or building's air system.

[View LCN control boxes](#)

SPECIFICATION RULES, ADDITIONAL OPTIONS AND PRICING ADDERS

Order of attributes when placing an order for a non-standard configuration. See parts section for individual parts pricing. Attributes show in CAPS are required. Other attributes are required only if you are deviating from the product's default.

MODEL . FINISH . Screw pack . Door thickness

Custom powder coat finishes	Specify	Price adder
Apply price adder to powder coat price		
Custom Power Coat Finish	RAL []	\$50.00
Brite Metallic Powder Coat	MTLPC	\$73.00
Screw package	Specify	Price adder
Wood and Machine Screws (WMS) - Default	-	-
Through Bolt Wood and Machine Screws	TBWMS	\$0.00
Door thickness	Specify	
Specify if door thickness is different than 1-3/4" when choosing a through bolt screw pack	[]	

Handing required

4820 SERIES

PNEUMATIC

The 4820 Auto Equalizer™ is LCN's pneumatically powered solution for top jamb surface mounted push side applications.. This low-energy automatic operator is designed for primarily manual scenarios with occasional automatic actuation.

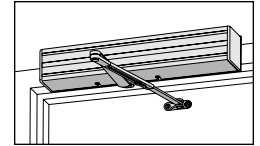

689	690	691	693	695	696	652	616	632	633	639	646	651
AL	STAT	LTBRZ	GLBLK	DKBRZ	BRASS	US26D	US11	US3	US4	US10	US15	US26

ACN for these commonly ordered products	PRICE BASED ON FINISH						
	POWDER COAT			PLATED			
	689	690	691	652	616	632	633
	693	695	696		639	646	651

DEFAULT CONFIGURATIONS					
Model	Arm	Finish			
4822	REGARM	[Finish]	\$2,687.00	\$3,176.00	\$3,492.00
4822	LONG	[Finish]	\$2,692.00	\$3,182.00	\$3,497.00

DEFAULT AND COMMON CONFIGURATIONS

Pricing includes default options shown below unless otherwise specified. Specification rules, additional options and pricing adders are shown in the tables below.

Cylinder

Cast Iron Cylinder Assembly (CYL)

Cover

Metal Cover (MC)

Screw package

Wood and Machine Screws (WMS)

BAA Compliant

See the [Allegion Buy America/ Buy American and Trade Agreement Acts \(BAA and TAA\) Compliance Guide](#) for full details

The 4820 requires a control box and air source to complete the system. It can be paired with a 7980 Series control box with a built-in compressor or a 7900 Series control box along with a third party compressor or building's air system.

[View LCN control boxes](#)

SPECIFICATION RULES, ADDITIONAL OPTIONS AND PRICING ADDERS

Order of attributes when placing an order for a non-standard configuration. See parts section for individual parts pricing. Attributes show in CAPS are required. Other attributes are required only if you are deviating from the product's default.

MODEL . Cylinder . ARM TYPE . FINISH . Screw pack . Flush ceiling application . Door thickness

Cylinder	Specify	Price adder
Cast Iron Cylinder Assembly (CYL) - Default	-	-
Standard Cylinder with 18G Mounting Plate	CYL18G	\$0.00
Custom powder coat finishes	Specify	Price adder
Apply price adder to powder coat price		
Custom Power Coat Finish	RAL []	\$50.00
Brite Metallic Powder Coat	MTLPC	\$73.00
Screw package	Specify	Price adder
Wood and Machine Screws (WMS) - Default	-	-
Through Bolt Wood and Machine Screws	TBWMS	\$0.00
Flush ceiling application	Specify	Price adder
Flush Ceiling Application	FCA	\$0.00
Door thickness	Specify	
Specify if door thickness is different than 1-3/4" when choosing a through bolt screw pack	[]	

Handing required

4840 SERIES

PNEUMATIC

The 4840 Auto Equalizer™ is LCN's pneumatic solution for door mounted, parallel arm, push side applications. This low-energy automatic operator is designed for primarily manual scenarios with occasional automatic actuation.

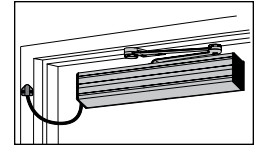

Shown with 4840-459 door loop

689	690	691	693	695	696	652	616	632	633	639	646	651
AL	STAT	LTBRZ	GLBLK	DKBRZ	BRASS	US26D	US11	US3	US4	US10	US15	US26

ACN for these commonly ordered products	PRICE BASED ON FINISH						
	POWDER COAT			PLATED			
	689	690	691	652	616	632	633
	693	695	696		639	646	651

DEFAULT CONFIGURATIONS			
Model	Arm	Finish	
4841	EDA	[Finish]	\$2,736.00 \$3,224.00 \$3,541.00
4841	CUSH	[Finish]	\$2,773.00 \$3,262.00 \$3,578.00
4841	SCUSH	[Finish]	\$2,866.00 \$3,353.00 \$3,671.00

DEFAULT AND COMMON CONFIGURATIONS

Pricing includes default options shown below unless otherwise specified. Specification rules, additional options and pricing adders are shown in the tables below.

Cylinder
Cast Iron Cylinder Assembly (CYL)

Cover
Metal Cover (MC)

Screw package
Wood and Machine Screws (WMS)

BAA Compliant
See the [Allegion Buy America/ Buy American and Trade Agreement Acts \(BAA and TAA\) Compliance Guide](#) for full details

! The 4840 requires a control box and air source to complete the system. It can be paired with a 7980 Series control box with a built-in compressor or a 7900 Series control box along with a third party compressor or building's air system.

[View LCN control boxes](#)

SPECIFICATION RULES, ADDITIONAL OPTIONS AND PRICING ADDERS

Order of attributes when placing an order for a non-standard configuration. See parts section for individual parts pricing. Attributes show in CAPS are required. Other attributes are required only if you are deviating from the product's default.

MODEL . ARM TYPE . FINISH . Screw pack . Door thickness

Custom powder coat finishes	Specify	Price adder
Apply price adder to powder coat price		
Custom Power Coat Finish	RAL []	\$50.00
Brite Metallic Powder Coat	MTLPC	\$73.00
Screw package	Specify	Price adder
Wood and Machine Screws (WMS) - Default	-	-
Through Bolt Wood and Machine Screws	TBWMS	\$0.00
Door thickness	Specify	
Specify if door thickness is different than 1-3/4" when choosing a through bolt screw pack	[]	

! Handing required

7900 SERIES CONTROL BOXES

- Use -925 Pneumatic Tubing to connect operator and control box.
- 7900 Series Control Boxes require a separate air source, LCN 900 Series Compressors are recommended.

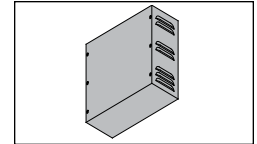

Dimensions: 15" x 15" x 6"

7980 Series Control Boxes	Specify	Price
7980 Series Control Boxes should be installed within 50 linear tubing feet of the automatic operator(s).		
Control Box, Pneumatic Internal Compressor Self-contained control box/compressor combination for single door application. Includes -3960 Compressor Assembly.	7981	\$4,023.00
Control Box, Pneumatic Electric Strike (ES) Relay, Internal Compressor Self-contained control box/compressor combination for single door application. Includes -3960 Compressor Assembly, -3390A Relay.	7981ES	\$4,673.00
Control Box, Pneumatic Internal Compressor Self-contained control box/compressor combination for either independent or simultaneous operation of two (2) door leaves. Includes -3960 Compressor Assembly.	7982	\$5,695.00
Control Box, Pneumatic Sequential (S) Feature, Internal Compressor Self-contained control box/compressor combination for independent, simultaneous or sequential operation of two (2) door leaves. Includes -3960 Compressor Assembly, -3426 Sequencer Card.	7982S	\$6,189.00
Control Box, Pneumatic Electric Strike (ES) Relays, Internal Compressor Self-contained control box/compressor combination for independent or simultaneous operation of two (2) door leaves. Includes -3960 Compressor Assembly, -3390A & -3390B Relays.	7982ES	\$6,839.00
Control Box, Pneumatic Sequential (S) Feature, Electric Strike (ES) Relays, Internal Compressor Self-contained control box/compressor combination for independent, simultaneous or sequential operation of two (2) door leaves. Includes -3960 Compressor Assembly, -3390A & -3390B Relays, -3426 Sequencer Card.	7982SES	\$7,273.00
7900 Series Control Boxes	Specify	Price
7900 Series Control Boxes should be installed within 100 linear tubing feet of the automatic operator(s).		
Control Box, Pneumatic Single door application or independent control of single door in multiple door systems. Two door leaves can be operated, if activated simultaneously. Requires a separate 900 Series compressor.	7901	\$2,754.00
Control Box, Pneumatic Electric Strike (ES) Relay Single door application or independent control of single door in multiple door systems. Two door leaves can be operated, if activated simultaneously. Includes -3390A Relay. Requires a separate 900 Series compressor.	7901ES	\$3,404.00
Control Box, Pneumatic Independent operation of two (2) door leaves or simultaneous and/or sequential operation of four (4) door leaves. Requires a separate 900 Series compressor.	7902	\$3,776.00
Control Box, Pneumatic Sequential (S) Feature Independent operation of two (2) door leaves or simultaneous operation and/or sequential operation of four (4) door leaves. Includes -3426 Sequencer Card. Requires a separate 900 Series compressor.	7902S	\$4,271.00
Control Box, Pneumatic Electric Strike (ES) Relays Independent operation of two (2) door leaves or simultaneous of four (4) door leaves. Includes -3390A & -3390B Relays. Requires a separate 900 Series compressor.	7902ES	\$4,952.00
Control Box, Pneumatic Sequential (S), Electric Strike (ES) Relays Independent operation of two (2) door leaves or simultaneous and/or sequential operation of four (4) door leaves. Includes -3390A & -3390B Relays, -3426 Sequencer Card. Requires a separate 900 Series compressor.	7902SES	\$5,385.00
7940 Series Control Boxes - (Requires LCN 900 Series compressor)	Specify	Price
7940 Series Control Boxes should be installed within 100 linear tubing feet of the automatic operator(s). A 'blow-open' system requires a separate air source. A 'blow-open' system that includes an automatic or power operator function also requires a separate air source and is limited to the operation of two (2) door leaves.		
Control Box, Pneumatic, Auxiliary 'Blow-Open' Control box works with or without 7901/7902 Series Control Box and one or two pneumatic Auto Equalizers. Controlled by the smoke evacuation system, the 7949 Series Control Box will open the door(s) to allow fresh air into building.	7949	\$2,291.00
Control Box, Pneumatic, Auxiliary 'Blow-Open', Electric Strike (ES) Relay Auxiliary 'blow-open' control box works with or without 7901ES/7902ES Series Control Box and one or two pneumatic Auto Equalizers. Controlled by the smoke evacuation system, the 7949 Series Control Box will unlock and open the door(s) to allow fresh air into building.	7949ES	\$2,847.00

☞ Handing required

7900 SERIES CONTROL BOX COMPONENTS

293G	329G	329	929	962	3299A	3299B	3390A
900		903		3426			
941		941C		942			
925		3960		3592			
7902SES		7982SES		7949ES			

Handing required

1000 SERIES

4000 SERIES

CONCEALED

FIRE/LIFE SAFETY

HIGH SECURITY

AUTO OPERATORS

ACTUATORS, ACCESSORIES

MISC.

7900 SERIES CONTROL BOX COMPONENTS

Control box components		Specify	Price
Muffler	Exhaust muffler for 7901, 7902, 7981, or 7982 Series control boxes.	293G	\$37.00
Fitting, "T"	"T" fitting to connect 925 pneumatic tubing.	319	\$7.00
Fitting, "Inline"	"Inline" fitting to connect 925 pneumatic tubing.	320	\$7.00
Air filter assembly	Replacement inlet air filter for the 7981 or 7982 Series control boxes.	329	\$86.00
Air filter assembly	Replacement inlet air filter for the 7901 or 7902 Series control boxes. Includes -929 air filter assembly.	329G	\$284.00
Power supply, 10T	Main power supply/input board for the 7901, 7902, 7981, and 7982 Series control boxes. Ten (10) terminals.	900	\$657.00
Timer module	0-30 second timer module for 7901, 7902, 7981, and 7982 Series control box. Plugs into the -900 power supply board.	903	\$291.00
Pneumatic tubing	Flexible pneumatic tubing with an 1/8" inner diameter and 1/4" outer diameter. Specify number of linear feet required when ordering.	925	\$6.00
Filter and seal	Internal filter and seal component to the 329G air filter assembly.	929	\$37.00
Valve assembly	Regulator valve assembly for the 7901 Series control box.	941	\$990.00
Valve assembly	Regulator valve assembly for the 7949 Series control box.	941C	\$990.00
Valve assembly	Regulator valve assembly for the 7902 Series control box.	942	\$1,918.00
Isolator	Rubber isolator for 7981 or 7982 compressor (-3960) assembly.	962	\$31.00
Solenoid assembly valve 'A'	Air valve assembly for the 7981 Series control box or the 'A' circuit valve assembly in the 7982 Series control box.	3299A	\$557.00
Solenoid assembly valve 'B'	Air valve assembly for the 'B' circuit in the 7982 Series control box.	3299B	\$607.00
Copper coupler	Converts pneumatic tubing connection to copper.	3328	\$31.00
'A' relay package	Electric strike (ES) relay for 7901 and 7982 Series control boxes or the 'A' circuit ES relay assembly used in the 7902 and 7982. Series control boxes. Can be added to a standard control box to convert to ES operation. Includes -390 Relay, relay base and wire harness. The 3390A is included when either a 7901ES, 7902ES, 7981ES or 7982ES is ordered.	3390A	\$649.00
'B' relay package	Electric strike (ES) relay for 'B' circuit in either the 7902 or 7982 Series control boxes. Can be added to a standard control box to convert to ES operation. Includes -390 Relay, relay base and wire harness. The 3390B is included when either a 7902ES or 7982ES is ordered.	3390B	\$649.00
'C' relay package	Electric strike (ES) relay assembly for the 7949 Series 'blow-open' control box. Includes -390C Relay, relay base and wire harness. The 3390C is included when a 7949ES is ordered.	3390C	\$649.00
Sequencer card	Dual, 0-30 second timer module for 7902 or 7982 Series control box. Can be added to a standard 7902 or 7982 Series control box to convert box to sequential operation.-3426 Sequencer card is included when either a 7902S or 7982S Series control box is ordered.	3426	\$433.00
Compressor service kit	Service kit for air pressure adjustment in the either the 7981 or 7982 Series control box.	3592	\$93.00
Compressor assembly	Internal air pump assembly for the 7981 or 7982 Series control box. -3960 compressor assembly includes starter capacitor, -962 isolators and -329 air filter assembly.	3960	\$2,475.00

 Handing required

PARTS AND ACCESSORIES

Powder coat

689	Aluminum (AL)
690	Statuary Bronze (STAT)
691	Light Bronze (LTBRZ)
693	Black (GLBLK)
695	Dark Bronze (DKBRZ)
696	Brass (BRASS)

Plated

616	Satin Bronze, Blackened (US11)
632	Brass (US3)
633	Satin Brass (US4)
639	Satin Bronze (US10)
646	Satin Nickel (US15)
651	Bright Chrome (US26)
652	Satin Chrome (US26D)

Anodized

628	Aluminum (ANCLR)
710	Dark Bronze (ANDKB)

Handing

RH	Right hand
LH	Left hand

2610 Series	Specify			Price		
	Part number	Finish	Handing	Powder coat	652 plated	Other plated
Std Cylinder Assembly	2613(4)-3071	.[Finish]	.[Handing]	\$2,588.00	\$2,805.00	\$3,083.00
DPS Cylinder Assembly	2613(4)-3071DPS	.[Finish]	.[Handing]	\$2,724.00	\$2,940.00	\$3,218.00
Cylinder Only	2613(4)-3971	-	.[Handing]	\$1,900.00	-	-
DPS Cylinder Only	2613(4)-3971DPS	-	.[Handing]	\$2,036.00	-	-
Standard Arm	2610-3077T	.[Finish]	.[Handing]	\$149.00	\$422.00	\$459.00
Standard Track	2610-3038	.[Finish]	-	\$93.00	-	-
Screw Pack (incl -3034)	2610-WMS	.[Finish]	-	\$63.00	\$86.00	\$105.00
Spacer	2610-61	-	-	\$19.00	-	-
Arm and Tube	2610-78	.[Finish]	.[Handing]	\$93.00	-	-
Rod	2610-82	.[Finish]	-	\$73.00	-	-
H Arm Screw	2610-83H	.[Finish]	-	\$7.00	-	-
Arm Screw	2610-159	.[Finish]	-	\$7.00	-	-
Roller Lock Screw	2610-425	-	-	\$9.00	-	-
Mounting/Finish Plate	2610-3002	.[Finish]	.[Handing]	\$186.00	\$545.00	\$582.00
Track Roller	2610-3034	-	-	\$37.00	-	-
Flat Box w/Label	2610-Flat Box	-	-	\$9.00	-	-
Instruction Sheet	2610-Instruction Sheet	-	-	\$7.00	-	-
Box and Instruction Sheet	2610-Rebox Kit	-	-	\$9.00	-	-

4810 Series	Specify			Price		
	Part number	Finish	Handing	Powder coat	652 plated	Other plated
Std Cylinder Assembly	4811-3071	.[Finish]	-	\$2,259.00	-	-
Cylinder Only	4811-3971	-	-	\$2,166.00	-	-
Standard Arm	4810-3077T	.[Finish]	-	\$149.00	\$422.00	\$459.00
Standard Track	4810-3038	.[Finish]	-	\$93.00	-	-
Screw Pack (incl -3034)	4810-WMS	.[Finish]	-	\$63.00	\$86.00	\$105.00
Screw Pack (incl -3034)	4810-TBWMS	.[Finish]	-	\$63.00	\$86.00	\$105.00
Plate	4810-18	.[Finish]	-	\$310.00	\$470.00	\$508.00
Cover Screw	4810-31	.[Finish]	-	\$7.00	-	-
Long Cover Screw	4810-31L	.[Finish]	-	\$7.00	-	-
Spacer	4810-61	-	-	\$19.00	-	-
End Cap	4810-73	-	-	\$14.00	-	-
Arm and Tube	4810-78	.[Finish]	-	\$93.00	\$216.00	\$253.00
Rod	4810-82	.[Finish]	-	\$73.00	-	-
H Arm Screw	4810-83H	.[Finish]	-	\$7.00	-	-
Plug	4810-141-2	.[Finish]	-	\$7.00	-	-

Handed

4810 Series	Specify			Price		
	Part number	Finish	Handing	Powder coat	652 plated	Other plated
Arm Screw	4810-159	.[Finish]	-	\$7.00	-	-
Cover Insert	4810-163	-	-	\$9.00	-	-
Stand Off	4810-182	-	-	\$19.00	-	-
Cover End Cap	4810-334	-	-	\$16.00	-	-
Roller Lock Screw	4810-425	-	-	\$9.00	-	-
Track Roller	4810-3034	-	-	\$37.00	-	-
Flat Box w/Label	4810-Flat Box	-	-	\$9.00	-	-
Instruction Sheet	4810-Instruction Sheet	-	-	\$7.00	-	-
Box and Instruction Sheet	4810-Rebox Kit	-	-	\$9.00	-	-

4820 Series	Specify			Price		
	Part number	Finish	Handing	Powder coat	652 plated	Other plated
Std Cylinder Assembly	4822-3071	.[Finish]	-	\$2,259.00	-	-
Std Cylinder Assembly w/18G	4822-3071/18G	.[Finish]	-	\$2,259.00	-	-
Cylinder Only	4822-3971	-	-	\$2,166.00	-	-
Reg Arm	4820-3077	.[Finish]	-	\$149.00	\$422.00	\$459.00
Long Arm	4820-3077L	.[Finish]	-	\$154.00	\$428.00	\$464.00
Metal Cover	4820-72MC	.[Finish]	-	\$279.00	\$495.00	\$774.00
Screw Pack	4820-WMS	.[Finish]	-	\$31.00	\$55.00	\$73.00
Screw Pack	4820-TBWMS	.[Finish]	-	\$31.00	\$55.00	\$73.00
Plate	4820-18	.[Finish]	-	\$310.00	\$470.00	\$508.00
Plate	4820-18G	.[Finish]	-	\$310.00	\$470.00	\$508.00
Cover Screw	4820-31	.[Finish]	-	\$7.00	-	-
Long Cover Screw	4820-31L	.[Finish]	-	\$7.00	-	-
Arm and Forearm	4820-77	.[Finish]	-	\$149.00	\$321.00	\$360.00
Rod and Shoe	4820-79	.[Finish]	-	\$37.00	\$93.00	\$130.00
Long Rod and Shoe	4820-79LR	.[Finish]	-	\$68.00	\$144.00	\$180.00
Arm Screw	4820-83	.[Finish]	-	\$7.00	-	-
Arm Screw	4820-159	.[Finish]	-	\$7.00	-	-
Cover Insert	4820-163	-	-	\$9.00	-	-
Stand Off	4820-182	-	-	\$19.00	-	-
Cover End Cap	4820-334	-	-	\$16.00	-	-
☞ DPS Conversion Kit	4820-3377	-	.[Handing]	\$501.00	-	-
Flat Box w/Label	4820-Flat Box	-	-	\$9.00	-	-
Instruction Sheet	4820-Instruction Sheet	-	-	\$7.00	-	-
Box and Instruction Sheet	4820-Rebox Kit	-	-	\$9.00	-	-

☞ Handing required

PARTS AND ACCESSORIES

Powder coat

689	Aluminum (AL)
690	Statuary Bronze (STAT)
691	Light Bronze (LTBRZ)
693	Black (GLBLK)
695	Dark Bronze (DKBRZ)
696	Brass (BRASS)

Plated

616	Satin Bronze, Blackened (US11)
632	Brass (US3)
633	Satin Brass (US4)
639	Satin Bronze (US10)
646	Satin Nickel (US15)
651	Bright Chrome (US26)
652	Satin Chrome (US26D)

Anodized

628	Aluminum (ANCLR)
710	Dark Bronze (ANDKB)

Handing

RH	Right hand
LH	Left hand

4840 Series	Specify			Price		
	Part number	Finish	Handing	Powder coat	652 plated	Other plated
Std Cylinder Assembly	4841-3071	.[Finish]	-	\$2,259.00	-	-
Cylinder Only	4841-3971	.[Finish]	-	\$2,166.00	-	-
EDA Arm	4840-3077EDA	.[Finish]	-	\$198.00	\$470.00	\$508.00
Cush Arm	4840-3077CNS	.[Finish]	-	\$235.00	\$508.00	\$545.00
Spring Cush Arm	4840-3077SCNS	.[Finish]	-	\$328.00	\$599.00	\$638.00
Metal Cover	4840-72MC	.[Finish]	-	\$279.00	\$495.00	\$774.00
Screw Pack	4840-WMS	.[Finish]	-	\$31.00	\$55.00	\$73.00
Screw Pack	4840-TBWMS	.[Finish]	-	\$31.00	\$55.00	\$73.00
Cush Shoe Support	4840-30	.[Finish]	-	\$26.00	\$81.00	\$118.00
Cover Screw	4840-31	.[Finish]	-	\$7.00	-	-
Long Cover Screw	4840-31L	.[Finish]	-	\$7.00	-	-
Blade Stop Spacer	4840-61	.[Finish]	-	\$31.00	\$86.00	\$123.00
Plug	4840-124	.[Finish]	-	\$7.00	-	-
Arm Screw	4840-159	.[Finish]	-	\$7.00	-	-
Cover Insert	4840-163	-	-	\$9.00	-	-
Stand Off	4840-182	-	-	\$19.00	-	-
5th Screw Spacer	4840-201	-	-	\$9.00	-	-
Cover End Cap	4840-334	-	-	\$19.00	-	-
Panel Adapter	4840-419	.[Finish]	-	\$81.00	\$186.00	\$224.00
Door Loop Kit	4840-459	-	-	\$174.00	-	-
Pneumatic Hinge	4840-460	-	-	\$631.00	-	-
Spring Cush Block	4840-3080	.[Finish]	-	\$81.00	-	-
Flat Box w/Label	4840-Flat Box	-	-	\$9.00	-	-
Instruction Sheet	4840-Instruction Sheet	-	-	\$7.00	-	-
Box and Instruction Sheet	4840-Rebox Kit	-	-	\$9.00	-	-

Handed

this page intentionally blank

4630 SERIES

ELECTROHYDRAULIC

The 4630 auto equalizer is LCN's smart and reliable electrohydraulic operator. This low energy operator is designed for primarily manual scenarios with occasional automatic actuation.

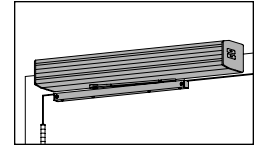

689	690	691	693	695	696	652	616	632	633	639	646	651		
AL	STAT	LTBRZ	GLBLK	DKBRZ	BRASS	US26D	US11	US3	US4	US10	US15	US26		
ACN for these commonly ordered products						PRICE BASED ON FINISH								
						POWDER COAT			PLATED					
						689	690	691	652	616	632	633		
						693	695	696		639	646	651		
DEFAULT CONFIGURATIONS														
Model . Finish														
4631 . [Finish]		\$7,218.00	\$7,707.00	\$8,023.00										

DEFAULT AND COMMON CONFIGURATIONS

Pricing includes default options shown below unless otherwise specified. Specification rules, additional options and pricing adders are shown in the tables below.

Cylinder

Cast Iron Cylinder Assembly (CYL)

Arm type

Standard Arm (STDTRKARM)

Track type

Standard Track (STDTRK)

Cover

Metal Cover (MC)

Screw package

Wood and Machine Screws (WMS)

Voltage

120 Volts (120V)

BAA Compliant

See the [Allegion Buy America/ Buy American and Trade Agreement Acts \(BAA and TAA\) Compliance Guide](#) for full details

SPECIFICATION RULES, ADDITIONAL OPTIONS AND PRICING ADDERS

Order of attributes when placing an order for a non-standard configuration. See parts section for individual parts pricing. Attributes show in CAPS are required. Other attributes are required only if you are deviating from the product's default.

MODEL . FINISH . Screw pack . Door thickness . Concealed switch

Custom powder coat finishes	Specify	Price adder
Apply price adder to powder coat price		
Custom Power Coat Finish	RAL []	\$50.00
Brite Metallic Powder Coat	MTLPC	\$73.00
Screw package	Specify	Price adder
Wood and Machine Screws (WMS) - Default	-	-
Through Bolt Wood and Machine Screws	TBWMS	\$0.00
Torx Machine Screws	TORX	\$16.00
Through Bolt and Torx Machine Screws	TBTRX	\$16.00
Door thickness	Specify	
Specify if door thickness is different than 1-3/4" when choosing a through bolt screw pack	[]	
Concealed switch	Specify	Price adder
Concealed Switch	CS	\$0.00

✎ Handing required

1000 SERIES

4000 SERIES

CONCEALED

FIRE/LIFE SAFETY

HIGH SECURITY

AUTO OPERATORS

ACTUATORS, ACCESSORIES

MISC.

4640 SERIES

ELECTROHYDRAULIC

The 4640 auto equalizer is LCN's smart and reliable electrohydraulic automatic operator. This low energy operator is designed for primarily manual scenarios with occasional automatic actuation.

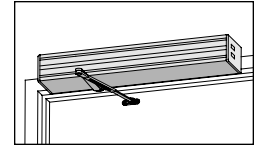

689	690	691	693	695	696	652	616	632	633	639	646	651
AL	STAT	LTBRZ	GLBLK	DKBRZ	BRASS	US26D	US11	US3	US4	US10	US15	US26

ACN for these commonly ordered products	PRICE BASED ON FINISH								
	POWDER COAT			PLATED					
	689	690	691	652			616	632	633
	693	695	696				639	646	651

DEFAULT CONFIGURATIONS						
Model	Arm	Finish				
4642	REGARM	[Finish]	\$7,125.00	\$7,614.00	\$7,930.00	
4642	LONG	[Finish]	\$7,130.00	\$7,620.00	\$7,935.00	

DEFAULT AND COMMON CONFIGURATIONS

Pricing includes default options shown below unless otherwise specified. Specification rules, additional options and pricing adders are shown in the tables below.

Cylinder

Cast Iron Cylinder Assembly (CYL)

Cover

Metal Cover (MC)

Screw package

Wood and Machine Screws (WMS)

Voltage

120 Volts (120V)

BAA Compliant

See the [Allegion Buy America/ Buy American and Trade Agreement Acts \(BAA and TAA\) Compliance Guide](#) for full details

SPECIFICATION RULES, ADDITIONAL OPTIONS AND PRICING ADDERS

Order of attributes when placing an order for a non-standard configuration. See parts section for individual parts pricing. Attributes show in CAPS are required. Other attributes are required only if you are deviating from the product's default.

MODEL . ARM TYPE . FINISH . Screw pack . Door thickness . Concealed switch

Custom powder coat finishes	Specify	Price adder
Apply price adder to powder coat price		
Custom Power Coat Finish	RAL []	\$50.00
Brite Metallic Powder Coat	MTLPC	\$73.00
Screw package	Specify	Price adder
Wood and Machine Screws (WMS) - Default	-	-
Through Bolt Wood and Machine Screws	TBWMS	\$0.00
Torx Machine Screws	TORX	\$16.00
Through Bolt and Torx Machine Screws	TBTRX	\$16.00
Door thickness	Specify	
Specify if door thickness is different than 1-3/4" when choosing a through bolt screw pack	[]	
Concealed switch	Specify	Price adder
Concealed Switch	CS	\$0.00

☞ Handing required

6400 SERIES

ELECTROHYDRAULIC

The 6440 Compact is LCN's modular solution for door mounted or top jamb applications. This low-energy automatic operator is best for quick upgrades to automate 4040XP installations.

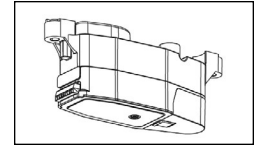

689	690	691	693	695	696	652	616	632	633	639	646	651
AL	STAT	LTBRZ	GLBLK	DKBRZ	BRASS	US26D	US11	US3	US4	US10	US15	US26
Kit description/contents		Specify		Price								
		Part number	Finish 689 (AL) or 695 (DKBRZ)									
Module kit <ul style="list-style-type: none"> ▪ Gearmotor assembly ▪ Cover ▪ Pluggable power supply ▪ Door loop ▪ 30 ft. of copper wire ▪ Necessary mounting hardware ⚠ Requires a separate 4040XP with REG or RwPA arm		6440	.[Finish]	\$1,163.00								
Module and hardwired touchless actuator kit <ul style="list-style-type: none"> ▪ Module kit components ▪ 8310-3813W touchless, line-powered, RF actuator kit ⚠ Requires a separate 4040XP with REG or RwPA arm		6440-3813W	.[Finish]	\$2,222.00								
Module and battery actuator kit <ul style="list-style-type: none"> ▪ Module kit components ▪ 8310-2210 touchless, battery-powered RF actuator kit ⚠ Requires a separate 4040XP with REG or RwPA arm		6440-2210	.[Finish]	\$1,987.00								
See next page for 6440XP Series details												

DEFAULT AND COMMON CONFIGURATIONS

Pricing includes default options shown below unless otherwise specified.

Cover

Plastic Cover (PC)

Voltage

24 VDC

Note: Components can be purchased individually. Review Replacement Parts section for non-kitted offerings.

⚠ Handing required

6440XP SERIES

ELECTROHYDRAULIC

The 6440XP is LCN's compact solution for door mounted or top jamb applications. This low-energy automatic operator is easy to install & best for free-swinging entryways.

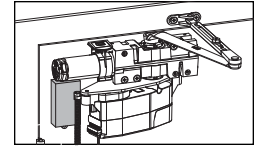

689	690	691	693	695	696	652	616	632	633	639	646	651
AL	STAT	LTBRZ	GLBLK	DKBRZ	BRASS	US26D	US11	US3	US4	US10	US15	US26

ACN for these commonly ordered products		PRICING FOR POWDER COAT FINISHES	
		689 (AL)	695 (DKBRZ)
DEFAULT CONFIGURATIONS			
Model	Finish		
6440XP	[Finish]	\$1,821.00	

6440XP includes a 6440 module kit and standard 4040XP cylinder with RwPA. Actuators are not included.

DEFAULT AND COMMON CONFIGURATIONS

Pricing includes default options shown below unless otherwise specified. Specification rules, additional options and pricing adders are shown in the tables below.

Cylinder
Cast Iron Cylinder Assembly (CYL)

Arm type
Regular Arm (RwPA)

Cover
Plastic Cover (PC)

Screw package
Wood and Machine Screws (CAWMS)

Voltage
24 VDC

BAA Compliant
See the [Allegion Buy America/ Buy American and Trade Agreement Acts \(BAA and TAA\) Compliance Guide](#) for full details

PARTS AND ACCESSORIES

Powder coat

689	Aluminum (AL)
690	Statuary Bronze (STAT)
691	Light Bronze (LTBRZ)
693	Black (GLBLK)
695	Dark Bronze (DKBRZ)
696	Brass (BRASS)

Plated

616	Satin Bronze, Blackened (US11)
632	Brass (US3)
633	Satin Brass (US4)
639	Satin Bronze (US10)
646	Satin Nickel (US15)
651	Bright Chrome (US26)
652	Satin Chrome (US26D)

Anodized

628	Aluminum (ANCLR)
710	Dark Bronze (ANDKB)

Handing

RH	Right hand
LH	Left hand

4630 Series	Specify			Price		
	Part number	Finish	Handing	Powder coat	652 plated	Other plated
Std Cylinder Assembly	4631-3071	.[Finish]	-	\$6,747.00	-	-
Cylinder Assembly w/Concealed I/O Switch	4631-3071CS	.[Finish]	-	\$6,747.00	-	-
Cylinder Only	4631-3971	-	-	\$2,377.00	-	-
Standard Arm	4630-3077T	.[Finish]	-	\$149.00	\$422.00	\$459.00
Standard Track	4630-3038	.[Finish]	-	\$93.00	-	-
Metal Cover	4630-72MC	.[Finish]	-	\$229.00	\$445.00	\$724.00
Screw Pack (incl -3034)	4630-WMS	.[Finish]	-	\$93.00	\$118.00	\$135.00
Screw Pack (incl -3034)	4630-TBWMS	.[Finish]	-	\$93.00	\$118.00	\$135.00
Screw Pack (incl -3034)	4630-TORX	.[Finish]	-	\$109.00	\$132.00	\$150.00
Screw Pack (incl -3034)	4630-TBTRX	.[Finish]	-	\$109.00	\$132.00	\$150.00
Cover Screw	4630-31	.[Finish]	-	\$7.00	-	-
Spacer	4630-61	-	-	\$19.00	-	-
End Cap	4630-73	-	-	\$14.00	-	-
Arm and Tube	4630-78	.[Finish]	-	\$93.00	\$216.00	\$253.00
Rod	4630-82	.[Finish]	-	\$73.00	\$149.00	\$186.00
H Arm Screw	4630-83H	.[Finish]	-	\$7.00	-	-
Plug	4630-141-2	.[Finish]	-	\$7.00	-	-
Arm Screw	4630-159	.[Finish]	-	\$7.00	-	-
End Cap with Switch Cutout	4630-334	-	-	\$50.00	-	-
End Cap, Plain	4630-334-2	.[Finish]	-	\$50.00	-	-
End Cap, Concealed Switch	4630-334CS	.[Finish]	-	\$50.00	-	-
Roller Lock Screw	4630-425	-	-	\$9.00	-	-
Shaft Extension	4630-480	.[Finish]	-	\$68.00	-	-
Mounting Plate Assembly	4630-3018	.[Finish]	-	\$3,961.00	-	-
Track Roller	4630-3034	-	-	\$37.00	-	-
On/Off Switch Assembly	4630-3179-1	-	-	\$63.00	-	-
Hold Open Switch Assembly	4630-3179-2	-	-	\$63.00	-	-
I/O Board Assembly	4630-3180	-	-	\$414.00	-	-
Motor/Clutch Assembly	4630-3454	-	-	\$1,969.00	-	-
Controller Assembly	4630-3462	-	-	\$2,240.00	-	-
Ribbon Cable Connector	4630-3498-1	-	-	\$31.00	-	-
A/C Power Cable	4630-3498-2	-	-	\$63.00	-	-
Flat Box w/Label	4630-Flat Box	-	-	\$9.00	-	-
Instruction Sheet	4630-Instruction Sheet	-	-	\$7.00	-	-
Box and Instruction Sheet	4630-Rebox Kit	-	-	\$9.00	-	-

Handed

4640 Series	Specify			Price		
	Part number	Finish	Handing	Powder coat	652 plated	Other plated
Std Cylinder Assembly	4642-3071	.[Finish]	-	\$6,747.00	-	-
Cylinder Assembly w/Concealed I/O Switch	4642-3071CS	.[Finish]	-	\$6,747.00	-	-
Cylinder Only	4642-3971	.[Finish]	-	\$2,377.00	-	-
Reg Arm	4640-3077	.[Finish]	-	\$149.00	\$422.00	\$459.00
Long Arm	4640-3077L	.[Finish]	-	\$154.00	\$428.00	\$464.00
Metal Cover	4640-72MC	.[Finish]	-	\$229.00	\$445.00	\$724.00
Screw Pack	4640-WMS	.[Finish]	-	\$63.00	\$86.00	\$105.00
Screw Pack	4640-TBWMS	.[Finish]	-	\$63.00	\$86.00	\$105.00
Screw Pack	4640-TORX	.[Finish]	-	\$79.00	\$102.00	\$120.00
Screw Pack	4640-TBTRX	.[Finish]	-	\$79.00	\$102.00	\$120.00
Cover Screw	4640-31	.[Finish]	-	\$7.00	-	-
Arm and Forearm	4640-77	.[Finish]	-	\$149.00	\$321.00	\$360.00
Rod and Shoe	4640-79	.[Finish]	-	\$37.00	\$93.00	\$130.00
Long Rod and Shoe	4640-79LR	.[Finish]	-	\$68.00	\$144.00	\$180.00
Arm Screw	4640-83	.[Finish]	-	\$7.00	-	-
Arm Screw	4640-159	.[Finish]	-	\$7.00	-	-
End Cap with Switch Cutout	4640-334	-	-	\$50.00	-	-
End Cap, Plain	4640-334-2	-	-	\$50.00	-	-
End Cap, Concealed Switch	4640-334CS	-	-	\$50.00	-	-
Shaft Extension	4640-480	-	-	\$68.00	-	-
Mounting Plate Assembly	4640-3018	.[Finish]	-	\$3,961.00	-	-
On/Off Switch Assembly	4640-3179-1	-	-	\$63.00	-	-
Hold Open Switch Assembly	4640-3179-2	-	-	\$63.00	-	-
I/O Board Assembly	4640-3180	-	-	\$414.00	-	-
Motor/Clutch Assembly	4640-3454	-	-	\$1,969.00	-	-
Controller Assembly	4640-3462	-	-	\$2,240.00	-	-
Ribbon Cable Connector	4640-3498-1	-	-	\$31.00	-	-
A/C Power Cable	4640-3498-2	-	-	\$63.00	-	-
Flat Box w/Label	4640-Flat Box	-	-	\$9.00	-	-
Instruction Sheet	4640-Instruction Sheet	-	-	\$7.00	-	-
Box and Instruction Sheet	4640-Rebox Kit	-	-	\$9.00	-	-

6400 Series	Specify			Price		
	Part number	Finish	Handing	Powder coat	652 plated	Other plated
Module (includes gearmotor assembly and screw bag; does not include mounting plate or cover)	6440-MD	-	-	\$736.00	-	-
Door Loop (includes screw bag)	6400-459	-	-	\$100.00	-	-
Wall Adapter (includes pluggable power supply and wire)	6400-470	-	-	\$206.00	-	-
Cover (includes system cover, cover switch insert and screw bag)	6440-72	.[Finish]	-	\$253.00	-	-
Screw Bag	6440-20	.[Finish]	-	\$35.00	-	-
Mounting Plate (includes screw bag)	6440-10	-	-	\$135.00	-	-
I/O Block (removable)	6440-441	-	-	\$30.00	-	-
Cover Switch Insert (includes ON/OFF switch insert with harness)	6440-54B	.[Finish]	-	\$83.00	-	-
Mounting Plate	6440-18	.[Finish]	-	\$75.00	-	-
Mounting Plate Top Jamb	6440-18TJ	.[Finish]	-	\$75.00	-	-
Mounting Plate Parallel Arm	6440-18PA	.[Finish]	-	\$75.00	-	-

✎ Handed

2810 SERIES

ELECTROMECHANICAL

The 2810 Senior Swing by LCN is a low energy, electromechanical automatic operator. The 2800 Senior Swing Series is designed for concealed applications. The 2810 is a single door operator and can be configured with a center pivot or offset pivot arm.

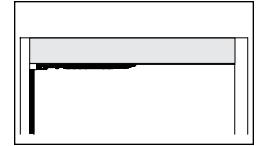

ACN for these commonly ordered products						PRICING FOR ANODIZED FINISHES	
						628 (ANCLR)	710 (ANDKB)
DEFAULT CONFIGURATIONS							
Model	Arm	Finish	Handing	Header	Header length ¹		
2811	ARMCP	[Finish]	[RH, LH]	HDR	[]	\$6,005.00	
2811	ARMCP	[Finish]	[RH, LH]	HDR2	[]	\$6,315.00	
2811	ARMOP	[Finish]	[RH, LH]	HDR	[]	\$6,098.00	
2811	ARMOP	[Finish]	[RH, LH]	HDR2	[]	\$6,408.00	
2811	ARMOP	[Finish]	[RH, LH]	HDR2MP	[]	\$6,718.00	

¹ Specify header length in 1/8" increments
 Header lengths 33 to 48" = HDR
 Header lengths 48.125" to 98" = HDR2
 Special header lengths 98" to 185" and/or special spindle centers require a drawing of the opening be submitted with the Purchase Order for validation. **Additional charge applies: 98-1/8" to 130" add \$310.00 to list price, 130-1/8" to 185" add \$620.00 to list price.**

DEFAULT AND COMMON CONFIGURATIONS

Pricing includes default options shown below unless otherwise specified. Specification rules, additional options and pricing adders are shown in the tables below.

Spindle center

Center pivot (ARMCP): 2-3/4
 Offset pivot (ARMOP): 3-3/4

Screw package

Machine Screws (MS)

Gearbox

Standard Motor Gearbox (MGB)

Controller

Standard Controller (CTRL)

Voltage

115 Volts (115V)

Closer stop

None

BAA Compliant

See the [Allegion Buy America/ Buy American and Trade Agreement Acts \(BAA and TAA\) Compliance Guide](#) for full details

SPECIFICATION RULES, ADDITIONAL OPTIONS AND PRICING ADDERS

Order of attributes when placing an order for a non-standard configuration. See parts section for individual parts pricing. Attributes show in CAPS are required. Other attributes are required only if you are deviating from the product's default.

MODEL . ARM TYPE . FINISH . HANDING . Voltage . HEADER . HEADER LENGTH . Closer stop

Handing	Specify	
Right hand	RH	
Left hand	LH	
Voltage	Specify	Price adder
115 Volts (115V) - Default	-	-
240 Volts - Optional	240V	\$0.00
Closer stop - Optional	Specify	Price adder
Positive Stop - 2-3/4 center pivot arm only	POS	\$32.00
Breakaway Stop - 2-3/4 center pivot arm only	BKY	\$129.00

Header and header length guidelines		
Single door (HDR)		
Arm type	Stop type	Header length options
Center pivot (ARMCP)	No Stop	33" - 48"
Center pivot (ARMCP)	Positive Mechanical Stop	36" - 48"
Center pivot (ARMCP)	Breakaway Stop	36" - 48"
Offset pivot (ARMOP)	No Stop	33" - 48"
Double door (HDR2) or double door, manual prep (HDR2MP)		
Arm type	Stop type	Header length options
Center pivot (ARMCP)	No Stop	48.125" - 98"
Center pivot (ARMCP)	Positive Mechanical Stop	48.125" - 98"
Center pivot (ARMCP)	Breakaway Stop	48.125" - 98"
Offset pivot (ARMOP)	No Stop	48.125" - 98"

☞ Handing required

2850 SERIES

ELECTROMECHANICAL

The 2850 Senior Swing by LCN is a low energy, electromechanical automatic operator. The 2800 Senior Swing Series is designed for concealed applications. The 2850 is a double door operator with two motor gearboxes and one controller. It can be configured with center pivot or offset pivot arms.

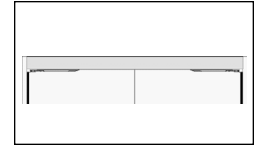

ACN for these commonly ordered products					PRICING FOR ANODIZED FINISHES	
					628 (ANCLR)	710 (ANDKB)
DEFAULT CONFIGURATIONS						
Model	Arm	Finish	Header	Header length ¹		
2853	ARMCP2	[Finish]	HDR2	[]		\$9,777.00
2853	ARMOP2	[Finish]	HDR2	[]		\$9,963.00

¹ Specify header length in 1/8" increments
Header lengths 48.125" to 98" = HDR2
Special header lengths 98" to 185" and/or special spindle centers require a drawing of the opening be submitted with the Purchase Order for validation. **Additional charge applies: 98-1/8" to 130" add \$310.00 to list price, 130-1/8" to 185" add \$620.00 to list price.**

DEFAULT AND COMMON CONFIGURATIONS

Pricing includes default options shown below unless otherwise specified. Specification rules, additional options and pricing adders are shown in the tables below.

Spindle center

Center pivot (ARMCP): 2-3/4
Offset pivot (ARMOP): 3-3/4

Screw package

Machine Screws (MS)

Gearbox

Standard Motor Gearbox, Pair (MGB2)

Controller

Standard Controller (CTRL)

Voltage

115 Volts (115V)

Closer stop

None

BAA Compliant

See the [Allegion Buy America/ Buy American and Trade Agreement Acts \(BAA and TAA\) Compliance Guide](#) for full details

SPECIFICATION RULES, ADDITIONAL OPTIONS AND PRICING ADDERS

Order of attributes when placing an order for a non-standard configuration. See parts section for individual parts pricing. Attributes show in CAPS are required. Other attributes are required only if you are deviating from the product's default.

MODEL . ARM TYPE . FINISH . Voltage . HEADER . HEADER LENGTH . Closer stop

Voltage	Specify	Price adder
115 Volts (115V) - Default	-	-
240 Volts - Optional	240V	\$0.00
Closer stop - Optional	Specify	Price adder
Positive Stop - 2-3/4 center pivot arm only	POS	\$65.00
Breakaway Stop - 2-3/4 center pivot arm only	BKY	\$257.00

Header and header length guidelines		
Double door (HDR2)		
Arm type	Stop type	Header length options
Center pivot (ARMCP)	No Stop	70" - 98"
Center pivot (ARMCP)	Positive Mechanical Stop	70" - 98"
Center pivot (ARMCP)	Breakaway Stop	70" - 98"
Offset pivot (ARMOP)	No Stop	52" - 98"

☞ Handing required

2860 SERIES

MECHANICAL

The 2860 Senior Swing by LCN is a low energy, electromechanical automatic operator. The 2800 Senior Swing Series is designed for concealed applications. The 2860 is a double door operator with two motor gearboxes and two controllers. It can be configured with center pivot or offset pivot arms.

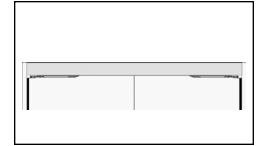

ACN for these commonly ordered products					PRICING FOR ANODIZED FINISHES	
					628 (ANCLR)	710 (ANDKB)
DEFAULT CONFIGURATIONS						
Model	Arm	Finish	Header	Header length ¹		
2863	ARMCP2	[Finish]	HDR2	[]	\$9,774.00	
2863	ARMOP2	[Finish]	HDR2	[]	\$9,935.00	

¹ Specify header length in 1/8" increments
 Header lengths 48.125" to 98" = HDR2
 Special header lengths 98" to 185" and/or special spindle centers require a drawing of the opening be submitted with the Purchase Order for validation. **Additional charge applies: 98-1/8" to 130" add \$310.00 to list price, 130-1/8" to 185" add \$620.00 to list price.**

DEFAULT AND COMMON CONFIGURATIONS

Pricing includes default options shown below unless otherwise specified. Specification rules, additional options and pricing adders are shown in the tables below.

Spindle center

Center pivot (ARMCP): 2-3/4
 Offset pivot (ARMOP): 3-3/4

Screw package

Machine Screws (MS)

Gearbox

Standard Motor Gearbox, Pair (MGB2)

Controller

Standard Controller, Pair (CTRL2)

Voltage

115 Volts (115V)

Closer stop

None

BAA Compliant

See the [Allegion Buy America/ Buy American and Trade Agreement Acts \(BAA and TAA\) Compliance Guide](#) for full details

SPECIFICATION RULES, ADDITIONAL OPTIONS AND PRICING ADDERS

Order of attributes when placing an order for a non-standard configuration. See parts section for individual parts pricing. Attributes show in CAPS are required. Other attributes are required only if you are deviating from the product's default.

MODEL . ARM TYPE . FINISH . Voltage . HEADER . HEADER LENGTH . Closer stop

Voltage	Specify	Price adder
115 Volts (115V) - Default	-	-
240 Volts - Optional	240V	\$0.00
Closer stop - Optional	Specify	Price adder
Positive Stop - 2-3/4 center pivot arm only	POS	\$54.00
Breakaway Stop - 2-3/4 center pivot arm only	BKY	\$216.00

Header and header length guidelines		
Double door (HDR2)		
Arm type	Stop type	Header length options
Center pivot (ARMCP)	No Stop	65" - 98"
Center pivot (ARMCP)	Positive Mechanical Stop	70" - 98"
Center pivot (ARMCP)	Breakaway Stop	70" - 98"
Offset pivot (ARMOP)	No Stop	65" - 98"

☞ Handing required

9530 SERIES

MECHANICAL

The 9530 Senior Swing by LCN is a low energy, electromechanical automatic operator. The 9500 Senior Swing Series is designed for surface mount applications. The 9530 is a single door operator for pull side applications.

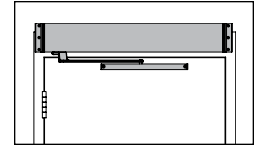

ACN for these commonly ordered products					PRICING FOR ANODIZED FINISHES	
					628 (ANCLR)	710 (ANDKB)
DEFAULT CONFIGURATIONS						
Model	Finish	Handing	Header	Header length ¹		
9531	[Finish]	[RH, LH]	HDR	[]	\$6,114.00	
9531	[Finish]	[RH, LH]	HDR2	[]	\$6,424.00	

¹ Specify header length in 1/8" increments
 Header lengths 33 to 48" = HDR
 Header lengths 48.125" to 98" = HDR2
 Special header lengths 98" to 185" and/or special spindle centers require a drawing of the opening be submitted with the Purchase Order for validation. **Additional charge applies: 98-1/8" to 130" add \$310.00 to list price, 130-1/8" to 185" add \$620.00 to list price.**

A mounting plate is suggested for hollow metal frame applications. Order as a separate item. **Length = header length plus 3-1/2"** when using angle brackets

MOUNTING PLATE			
Part number	Finish	Length	Price
9530-18	[Finish]	[]	\$98.00/ft

DEFAULT AND COMMON CONFIGURATIONS

Pricing includes default options shown below unless otherwise specified. Specification rules, additional options and pricing adders are shown in the tables below.

Arm type
 Standard Arm (STDTRKARM)

Track type
 Standard Track (STDTRK)

Spindle center
 Standard arm: 2-3/4

Screw package
 Machine Screws (MS)

Gearbox
 Standard Motor Gearbox (MGB)

Controller
 Standard Controller (CTRL)

Voltage
 115 Volts (115V)

Header bracket
 Angle brackets (HLB)

BAA Compliant
 See the [Allegion Buy America/ Buy American and Trade Agreement Acts \(BAA and TAA\) Compliance Guide](#) for full details

SPECIFICATION RULES, ADDITIONAL OPTIONS AND PRICING ADDERS

Order of attributes when placing an order for a non-standard configuration. See parts section for individual parts pricing. Attributes show in CAPS are required. Other attributes are required only if you are deviating from the product's default.

MODEL . FINISH . HANDING . Voltage . HEADER . HEADER LENGTH . Header bracket

Handing	Specify
Right hand	RH
Left hand	LH
Voltage	Specify Price adder
115 Volts (115V) - Default	- -
240 Volts - Optional	240V \$0.00
Header bracket	Specify Price adder
Angle brackets (HLB) - Default	- -
Dress Plates	HLD \$0.00

Header and header length guidelines	
Header type	Header length options
Single door (HDR)	33" - 48"
Double door (HDR2)	48-1/8" - 98"

Handing required

9540 SERIES

MECHANICAL

The 9540 Senior Swing by LCN is a low energy, electromechanical automatic operator. The 9500 Senior Swing Series is designed for surface mount applications. The 9540 is a single door operator for push side applications.

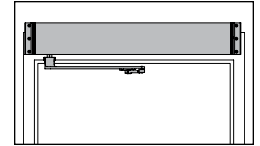

ACN for these commonly ordered products						PRICING FOR ANODIZED FINISHES	
						628 (ANCLR)	710 (ANDKB)
DEFAULT CONFIGURATIONS							
Model	Arm	Finish	Handing	Header	Header length		
9542	REGARM	[Finish]	[RH, LH]	HDR	[]	\$6,009.00	
9542	REGARM	[Finish]	[RH, LH]	HDR2	[]	\$6,319.00	
9542	LONG	[Finish]	[RH, LH]	HDR	[]	\$6,021.00	
9542	LONG	[Finish]	[RH, LH]	HDR2	[]	\$6,331.00	
ADDITIONAL COMMON CONFIGURATIONS							
Model	Arm	Finish	Handing	Header	Header length		
9542DPS	REGARM	[Finish]	[RH, LH]	HDR	[]	\$6,009.00	

DEFAULT AND COMMON CONFIGURATIONS

Pricing includes default options shown below unless otherwise specified. Specification rules, additional options and pricing adders are shown in the tables below.

Spindle center

Regular arm (REGARM): 2-3/4"; optional 12-1/4"

Screw package

Machine Screws (MS)

Gearbox

Standard Motor Gearbox (MGB)

Controller

Standard Controller (CTRL)

Voltage

115 Volts (115V)

Header bracket

Angle brackets (HLB)

BAA Compliant

See the [Allegion Buy America/ Buy American and Trade Agreement Acts \(BAA and TAA\) Compliance Guide](#) for full details

¹ Specify header length in 1/8" increments
 Header lengths 33 to 48" = HDR
 Header lengths 48.125" to 98" = HDR2
 Special header lengths 98" to 185" and/or special spindle centers require a drawing of the opening be submitted with the Purchase Order for validation. **Additional charge applies: 98-1/8" to 130" add \$310.00 to list price, 130-1/8" to 185" add \$620.00 to list price.**

A mounting plate is suggested for hollow metal frame applications. Order as a separate item.
Length = header length plus 3-1/2" when using angle brackets

MOUNTING PLATE			
Part number	Finish	Length	Price
9540-18	[Finish]	[]	\$98.00/ft

SPECIFICATION RULES, ADDITIONAL OPTIONS AND PRICING ADDERS

Order of attributes when placing an order for a non-standard configuration. See parts section for individual parts pricing. Attributes show in CAPS are required. Other attributes are required only if you are deviating from the product's default.

MODEL . ARM TYPE . FINISH . HANDING . Voltage . HEADER . HEADER LENGTH . Header bracket

Handing	Specify	
Right hand	RH	
Left hand	LH	
Voltage	Specify	Price adder
115 Volts (115V) - Default	-	-
240 Volts - Optional	240V	\$0.00
Header bracket	Specify	Price adder
Angle brackets (HLB) - Default	-	-
Dress Plates	HLD	\$0.00

Header and header length guidelines	
Header type	Header length options
Single door (HDR)	33" - 48"
Double door (HDR2)	48-1/8" - 98"

Handing required

9550 SERIES

MECHANICAL

The 9550 Senior Swing by LCN is a low energy, electromechanical automatic operator. The 9500 Senior Swing Series is designed for surface mount applications. The 9550 is a double door operator with two motor gearboxes and one controller. It can be configured for push, pull, or double egress applications.

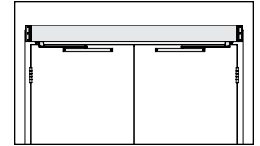

ACN for these commonly ordered products						PRICING FOR ANODIZED FINISHES	
						628 (ANCLR)	710 (ANDKB)
DEFAULT CONFIGURATIONS							
Model	Arm	Finish	Handing	Header	Header length		
9553	REGARM2	[Finish]	-	HDR2	[]	\$9,786.00	
9553	LONG2	[Finish]	-	HDR2	[]	\$9,786.00	
9553	STDTRKARM2	[Finish]	-	HDR2	[]	\$9,967.00	
☛ 9553	REGSTDDE	[Finish]	[RH, LH]	HDR2	[]	\$9,876.00	
ADDITIONAL COMMON CONFIGURATIONS							
Model	Arm	Finish	Handing	Header	Header length		
9553DPS	REGARM2	[Finish]	-	HDR2	[]	\$9,786.00	

¹ Specify header length in 1/8" increments
Header lengths 48.125" to 98" = HDR2
Special header lengths 98" to 185" and/or special spindle centers require a drawing of the opening be submitted with the Purchase Order for validation. **Additional charge applies: 98-1/8" to 130" add \$310.00 to list price, 130-1/8" to 185" add \$620.00 to list price.**

⚠ A mounting plate is suggested for hollow metal frame applications. Order as a separate item.
Length = header length plus 3-1/2" when using angle brackets

MOUNTING PLATE			Price
Part number	Finish	Length	
9550-18	[Finish]	[]	\$98.00/ft

DEFAULT AND COMMON CONFIGURATIONS

Pricing includes default options shown below unless otherwise specified. Specification rules, additional options and pricing adders are shown in the tables below.

Spindle center

Regular arm (REGARM2): 2-3/4"; optional 12-1/4"

Standard track arm (STDTRKARM2): 2-3/4"

Screw package

Machine Screws (MS)

Gearbox

Standard Motor Gearbox, Pair (MGB2)

Controller

Standard Controller (CTRL)

Voltage

115 Volts (115V)

Header bracket

Angle brackets (HLB)

BAA Compliant

See the [Allegion Buy America/ Buy American and Trade Agreement Acts \(BAA and TAA\) Compliance Guide](#) for full details

SPECIFICATION RULES, ADDITIONAL OPTIONS AND PRICING ADDERS

Order of attributes when placing an order for a non-standard configuration. See parts section for individual parts pricing. Attributes show in CAPS are required. Other attributes are required only if you are deviating from the product's default.

MODEL . ARM TYPE . FINISH . HANDING . Voltage . HEADER . HEADER LENGTH . Header bracket

Handing	Specify		
Right hand - Only required for REGSTDDE Arm	RH		
Left hand- Only required for REGSTDDE Arm	LH		
Voltage	Specify	Price adder	
115 Volts (115V) - Default	-	-	
240 Volts - Optional	240V	\$0.00	
Header bracket	Specify	Price adder	
Angle brackets (HLB) - Default	-	-	
Dress Plates	HLD	\$0.00	

Header and header length guidelines	
Double door (HDR2)	
Arm type	Header length options
REGARM2 (Push)	52" - 98"
LONG2 (Push)	52" - 98"
STDTRKARM2 (Pull)	54" - 98"
REGSTDDE (Double egress)	60" - 98"

☛ Handing required

9560 SERIES

MECHANICAL

The 9560 Senior Swing by LCN is a low energy, electromechanical automatic operator. The 9500 Senior Swing Series is designed for surface mount applications. The 9560 is a double door operator with two motor gearboxes and two controllers. It can be configured for push, pull, or double egress applications.

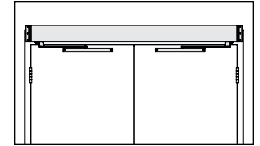

ACN for these commonly ordered products						PRICING FOR ANODIZED FINISHES	
						628 (ANCLR)	710 (ANDKB)
DEFAULT CONFIGURATIONS							
Model	Arm	Finish	Handing	Header	Header length		
9563	REGARM2	[Finish]	-	HDR2	[]	\$9,834.00	
9563	LONG2	[Finish]	-	HDR2	[]	\$9,834.00	
9563	STDTRKARM2	[Finish]	-	HDR2	[]	\$9,990.00	
9563	REGSTDDE	[Finish]	[RH, LH]	HDR2	[]	\$9,912.00	
ADDITIONAL COMMON CONFIGURATIONS							
Model	Arm	Finish	Handing	Header	Header length		
9563DPS	REGARM2	[Finish]	-	HDR2	[]	\$9,834.00	

DEFAULT AND COMMON CONFIGURATIONS

Pricing includes default options shown below unless otherwise specified. Specification rules, additional options and pricing adders are shown in the tables below.

Spindle center

Regular arm (REGARM2): 2-3/4; optional 12-1/4"

Standard track arm (STDTRKARM2): 2-3/4

Screw package

Machine Screws (MS)

Gearbox

Standard Motor Gearbox, Pair (MGB2)

Controller

Standard Controller, Pair (CTRL2)

Voltage

115 Volts (115V)

Header bracket

Angle brackets (HLB)

BAA Compliant

See the [Allegion Buy America/ Buy American and Trade Agreement Acts \(BAA and TAA\) Compliance Guide](#) for full details

¹ Specify header length in 1/8" increments
Header lengths 48.125" to 98" = HDR2
Special header lengths 98" to 185" and/or special spindle centers require a drawing of the opening be submitted with the Purchase Order for validation. **Additional charge applies: 98-1/8" to 130" add \$310.00 to list price, 130-1/8" to 185" add \$620.00 to list price.**

A mounting plate is suggested for hollow metal frame applications. Order as a separate item.
Length = header length plus 3-1/2" when using angle brackets

MOUNTING PLATE			Price
Part number	Finish	Length	
9560-18	[Finish]	[]	\$98.00/ft

SPECIFICATION RULES, ADDITIONAL OPTIONS AND PRICING ADDERS

Order of attributes when placing an order for a non-standard configuration. See parts section for individual parts pricing. Attributes show in CAPS are required. Other attributes are required only if you are deviating from the product's default.

MODEL . ARM TYPE . FINISH . HANDING . Voltage . HEADER . HEADER LENGTH . Header bracket

Handing	Specify
Right hand - Only required for REGSTDDE Arm	RH
Left hand- Only required for REGSTDDE Arm	LH
Voltage	Specify Price adder
115 Volts (115V) - Default	- -
240 Volts - Optional	240V \$0.00
Header bracket	Specify Price adder
Angle brackets (HLB) - Default	- -
Dress Plates	HLD \$0.00

Header and header length guidelines	
Header type	Header length options
Double door (HDR2)	65" - 98"

Handing required

9130 SERIES

MECHANICAL

The 9130 Benchmark by LCN is an electrically powered low-energy operator. It provides easy access for people with disabilities, or the elderly. Designed primarily for automatic opening applications that occasionally require manual opening. The Benchmark is a cost-effective solution for retrofitting an activated or manual door.

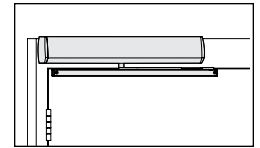

ACN for these commonly ordered products		PRICING FOR ANODIZED FINISHES	
		628 (ANCLR)	710 (ANDKB)
DEFAULT CONFIGURATIONS			
Model	Finish		
9131	[Finish]		\$4,344.00

DEFAULT AND COMMON CONFIGURATIONS

Pricing includes default options shown below unless otherwise specified. Specification rules, additional options and pricing adders are shown in the tables below.

Arm type
Standard Arm (STDTRKARM)

Track type
Standard Track (STDTRK)

Cover
Standard 27" Metal Cover (MC)

Screw package
Machine Screws (MS)

Gearbox
Standard Motor Gearbox (MGB)

Controller
Standard Controller (CTRL)

Voltage
115 Volts (115V)

BAA Compliant
See the [Allegion Buy America/ Buy American and Trade Agreement Acts \(BAA and TAA\) Compliance Guide](#) for full details

SPECIFICATION RULES, ADDITIONAL OPTIONS AND PRICING ADDERS

Order of attributes when placing an order for a non-standard configuration. See parts section for individual parts pricing. Attributes show in CAPS are required. Other attributes are required only if you are deviating from the product's default.

MODEL . FINISH . Cover . Voltage

Cover	Specify	Price adder
Standard 27" Metal Cover (MC) - Default	-	-
Full Metal Cover 36"	FMC	\$112.00
Voltage	Specify	Price adder
115 Volts (115V) - Default	-	-
240 Volts	240V	\$0.00

✎ Handing required

9140 SERIES

MECHANICAL

The 9140 Benchmark by LCN is an electrically powered low-energy operator. It provides easy access for people with disabilities, or the elderly. Designed primarily for automatic opening applications that occasionally require manual opening. The Benchmark is a cost-effective solution for retrofitting an activated or manual door.

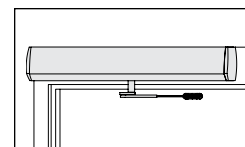

ACN for these commonly ordered products			PRICING FOR ANODIZED FINISHES	
			628 (ANCLR)	710 (ANDKB)
DEFAULT CONFIGURATIONS				
Model	Arm	Finish		
9142	REGARM	[Finish]	\$4,261.00	
9142	LONG	[Finish]	\$4,266.00	

DEFAULT AND COMMON CONFIGURATIONS

Pricing includes default options shown below unless otherwise specified. Specification rules, additional options and pricing adders are shown in the tables below.

Cover

Standard 27" Metal Cover (MC)

Screw package

Machine Screws (MS)

Gearbox

Standard Motor Gearbox (MGB)

Controller

Standard Controller (CTRL)

Voltage

115 Volts (115V)

BAA Compliant

See the [Allegion Buy America/ Buy American and Trade Agreement Acts \(BAA and TAA\) Compliance Guide](#) for full details

SPECIFICATION RULES, ADDITIONAL OPTIONS AND PRICING ADDERS

Order of attributes when placing an order for a non-standard configuration. See parts section for individual parts pricing. Attributes show in CAPS are required. Other attributes are required only if you are deviating from the product's default.

MODEL . ARM TYPE . FINISH . Cover . Voltage

Cover	Specify	Price adder
Standard 27" Metal Cover (MC) - Default	-	-
Full Metal Cover 36"	FMC	\$112.00
Voltage	Specify	Price adder
115 Volts (115V) - Default	-	-
240 Volts	240V	\$0.00

✎ Handing required

9150 SERIES

MECHANICAL

The 9150 Benchmark by LCN is an electrically powered low-energy operator. It provides easy access for people with disabilities, or the elderly. Designed primarily for automatic opening applications that occasionally require manual opening. The Benchmark is a cost-effective solution for retrofitting an activated or manual door.

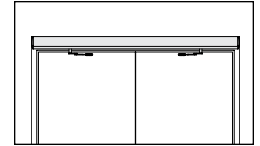

ACN for these commonly ordered products			PRICING FOR ANODIZED FINISHES	
			628 (ANCLR)	710 (ANDKB)
DEFAULT CONFIGURATIONS				
Model	Arm	Finish		
9153	REGARM2	[Finish]	\$8,428.00	
9153	LONG2	[Finish]	\$8,440.00	

DEFAULT AND COMMON CONFIGURATIONS

Pricing includes default options shown below unless otherwise specified. Specification rules, additional options and pricing adders are shown in the tables below.

Cover

Standard 72" Metal Cover (MC)

Screw package

Machine Screws (MS)

Gearbox

Standard Motor Gearbox Pair (MGB2)

Controller

Standard Controller Pair (CTRL2)

Voltage

115 Volts (115V)

BAA Compliant

See the [Allegion Buy America/ Buy American and Trade Agreement Acts \(BAA and TAA\) Compliance Guide](#) for full details

✎ Handing required

SENIOR SWING® BASIC PARTS DIAGRAM
(2800 / 9500 Series)

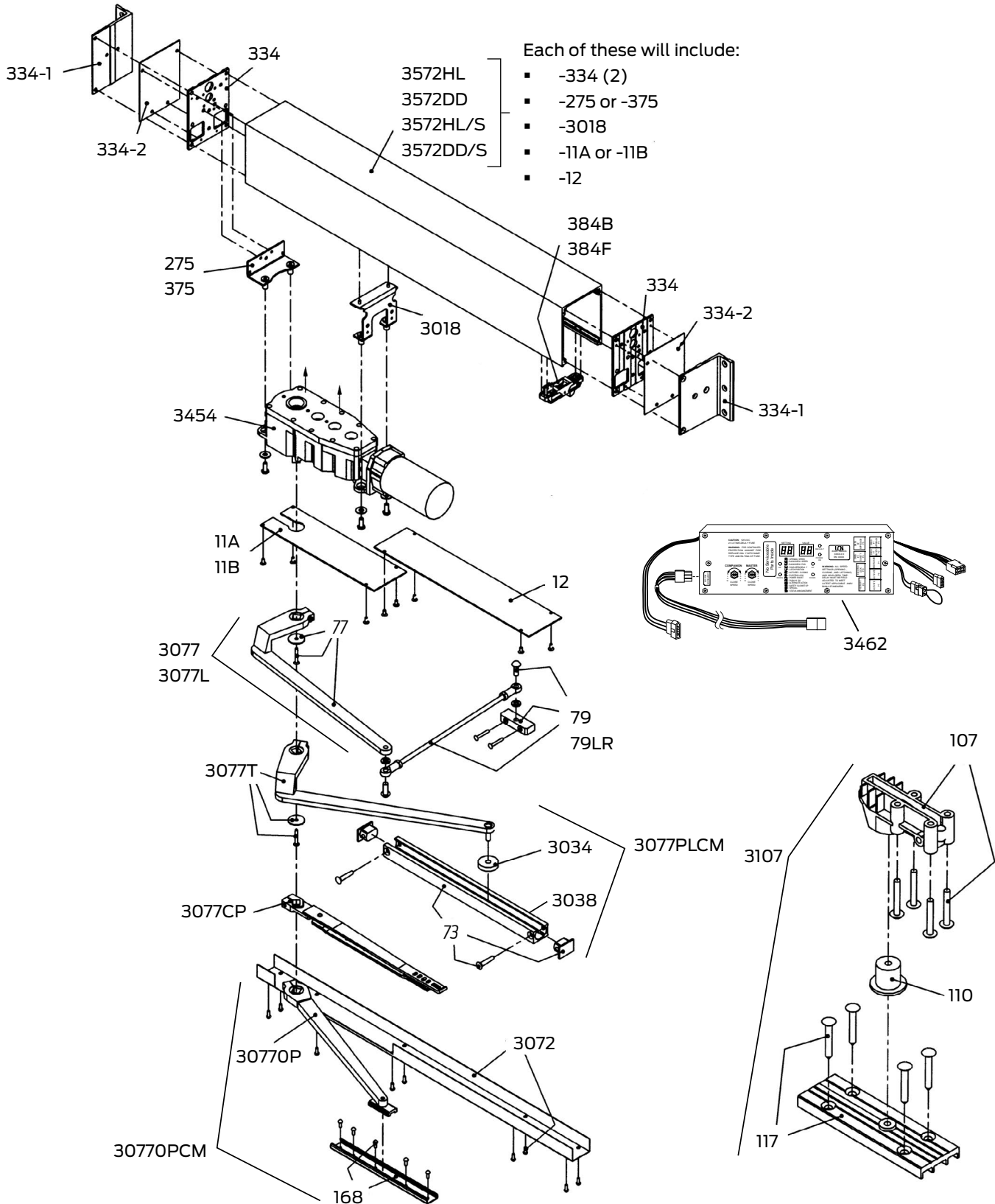

BENCHMARK BASIC PARTS DIAGRAM
(9100 Series)

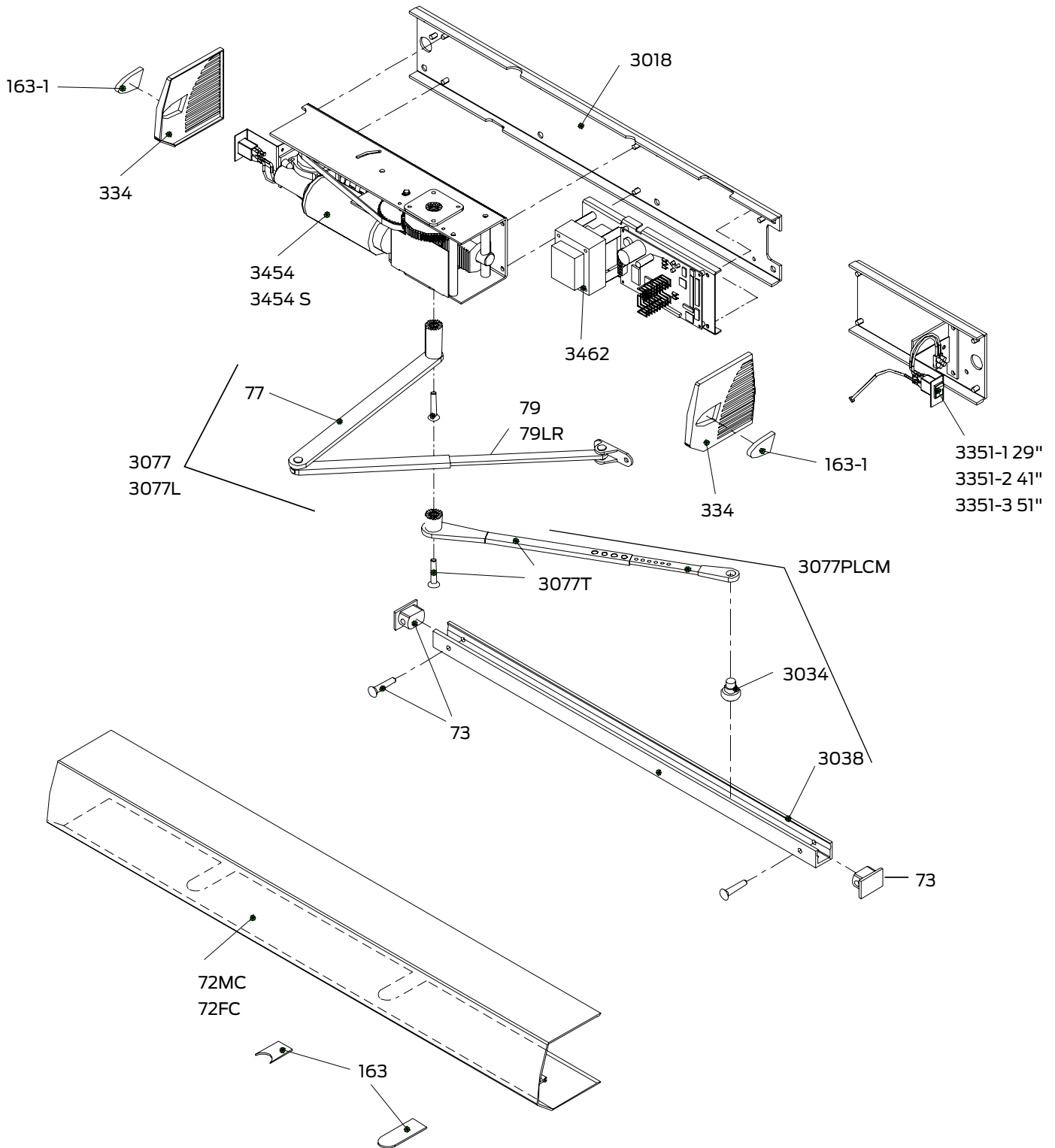

PARTS AND ACCESSORIES

Anodized
 628 Aluminum (ANCLR)
 710 Dark Bronze (ANDKB)

Handing
 RH Right hand
 LH Left hand

Dimensions
 Dimensions should be written in inches and fractions of an inch with a hyphen separating the whole number from the fraction. Example: 46-1/2.

2810 Series	Specify					Price
	Part number	Finish	Handing	Length	Spindle center	Anodized
Center Pivot Arm	2810-3077CP	-	-	-	-	\$310.00
Offset/Butt Hung Arm	2810-3077OP	.[Finish]	-	-	-	\$310.00
Offset Arm w/Track and Concealed Channel	2810-3077OPCM	.[Finish]	.[Handing]	.[Length]	-	\$545.00
Header Assembly	2810-3572HL	.[Finish]	-	.[Length]	.[Spindle center]	\$440.00
Header Assembly w/Stop Prep	2810-3572HL/S	.[Finish]	-	.[Length]	.[Spindle center]	\$440.00
Double Door Header Assembly	2810-3572DD	.[Finish]	-	.[Length]	.[Spindle center]	\$748.00
Double Door Header Assembly w/ Stop Prep	2810-3572DD/S	.[Finish]	-	.[Length]	.[Spindle center]	\$748.00
Double Door Header w/Manual Prep	2810-3572DD/MP	.[Finish]	-	.[Length]	.[Spindle center]	\$1,053.00
Screw Pack Header	2810-MS-HDR	.[Finish]	-	-	-	\$31.00
Screw Pack Center Pivot	2810-MS-CP	.[Finish]	-	-	-	\$31.00
Screw Pack Offset Pivot	2810-MS-OP	.[Finish]	-	-	-	\$31.00
Spindle Plate - 2-3/4"	2810-11A	.[Finish]	-	-	-	\$98.00
Spindle Plate - 3-3/4"	2810-11B	.[Finish]	-	-	-	\$98.00
Blank Filler Plate	2810-12	.[Finish]	-	.[Length]	.[Spindle center]	\$118.00
Arm and Tube	2810-78	.[Finish]	-	-	-	\$260.00
Rod	2810-82	.[Finish]	-	-	-	\$149.00
Pivot Body	2810-107	-	-	-	-	\$86.00
Pivot Post	2810-110	-	-	-	-	\$68.00
Bottom Pivot Plate	2810-117	-	-	-	-	\$68.00
Slide	2810-168	-	-	-	-	\$50.00
Mounting Bracket - 2-3/4"	2810-275	-	-	-	-	\$135.00
Header Endcaps	2810-334	.[Finish]	-	-	-	\$55.00
End Cap	2810-334-2	.[Finish]	-	-	-	\$98.00
Mounting Bracket - 3-3/4"	2810-375	-	-	-	-	\$130.00
Breakaway Door Stop	2810-384B	-	-	-	-	\$192.00
Fixed Door Stop	2810-384F	-	-	-	-	\$93.00
Dress Plate - Extrusion Only	2810-511	.[Finish]	-	.[Length]	-	\$26.00/ft
Cable/Parts Bag	2810-518	-	-	-	-	\$118.00
Header - Extrusion Only	2810-572	.[Finish]	-	.[Length]	-	\$68.00
Header Only	2810-572HL	.[Finish]	-	.[Length]	.[Spindle center]	\$282.00
Header Only w/Stop Prep	2810-572HL/S	.[Finish]	-	.[Length]	.[Spindle center]	\$282.00
Double Door Header Only	2810-572DD	.[Finish]	-	.[Length]	.[Spindle center]	\$597.00
Double Door Header Only w/Stop Prep	2810-572DD/S	.[Finish]	-	.[Length]	.[Spindle center]	\$597.00
Rear Mount Bracket	2810-3018	-	-	-	-	\$130.00

Handed

2810 Series	Specify					Price
	Part number	Finish	Handing	Length	Spindle center	Anodized
Concealing Channel	2810-3072	.[Finish]	.[Handing]	.[Length]	-	\$289.00
☞ Concealing Channel-Manual Prep	2810-3072MP	.[Finish]	.[Handing]	.[Length]	-	\$289.00
Bottom Pivot Assembly	2810-3107	-	-	-	-	\$208.00
☞ Motor Gearbox	2810-3454	-	.[Handing]	-	-	\$2,940.00
Controller	2810-3462	-	-	-	-	\$1,918.00

2850 Series	Specify					Price
	Part number	Finish	Handing	Length	Spindle center	Anodized
Center Pivot Arm	2850-3077CP	-	-	-	-	\$616.00
Offset/Butt Hung Arm	2850-3077OP	.[Finish]	-	-	-	\$616.00
Header Assembly	2850-3572HL	.[Finish]	-	.[Length]	.[Spindle center]	\$748.00
Header Assembly w/Stop Prep	2850-3572HL/S	.[Finish]	-	.[Length]	.[Spindle center]	\$743.00
Screw Pack Header	2850-MS-HDR	.[Finish]	-	-	-	\$63.00
Screw Pack Center Pivot	2850-MS-CP	.[Finish]	-	-	-	\$63.00
Screw Pack Offset Pivot	2850-MS-OP	.[Finish]	-	-	-	\$63.00
Spindle Plate - 2-3/4"	2850-11A	.[Finish]	-	-	-	\$98.00
Spindle Plate - 3-3/4"	2850-11B	.[Finish]	-	-	-	\$98.00
Arm and Tube	2850-78	.[Finish]	-	-	-	\$260.00
Rod	2850-82	.[Finish]	-	-	-	\$149.00
Pivot Body	2850-107	-	-	-	-	\$86.00
Pivot Post	2850-110	-	-	-	-	\$68.00
Bottom Pivot Plate	2850-117	-	-	-	-	\$68.00
Slide	2850-168	-	-	-	-	\$50.00
Mounting Bracket - 2-3/4"	2850-275	-	-	-	-	\$135.00
Header Endcaps	2850-334	.[Finish]	-	-	-	\$55.00
End Cap	2850-334-2	.[Finish]	-	-	-	\$98.00
Mounting Bracket - 3-3/4"	2850-375	-	-	-	-	\$130.00
Breakaway Door Stop	2850-384B	-	-	-	-	\$192.00
Fixed Door Stop	2850-384F	-	-	-	-	\$93.00
Cable/Parts Bag	2850-518	-	-	-	-	\$118.00
Header - Extrusion Only	2850-572	.[Finish]	-	.[Length]	-	\$70.00/ft
Header Only	2850-572HL	.[Finish]	-	.[Length]	.[Spindle center]	\$597.00
Header Only w/Stop Prep	2850-572HL/S	.[Finish]	-	.[Length]	.[Spindle center]	\$597.00
Companion Cable	2850-982	-	-	-	-	\$86.00
Rear Mount Bracket	2850-3018	-	-	-	-	\$130.00
Bottom Pivot Assembly	2850-3107	-	-	-	-	\$208.00
☞ Motor Gearbox (Std Force)	2850-3454	-	.[Handing]	-	-	\$2,940.00
Controller	2850-3462	-	-	-	-	\$1,918.00

☞ Handed

PARTS AND ACCESSORIES

Anodized
 628 Aluminum (ANCLR)
 710 Dark Bronze (ANDKB)

Handing
 RH Right hand
 LH Left hand

Dimensions
 Dimensions should be written in inches and fractions of an inch with a hyphen separating the whole number from the fraction. Example: 46-1/2.

2860 Series	Specify					Price
	Part number	Finish	Handing	Length	Spindle center	Anodized
Center Pivot Arm	2860-3077CP	-	-	-	-	\$600.00
Offset/Butt Hung Arm	2860-3077OP	.[Finish]	-	-	-	\$600.00
Header Assembly	2860-3572HL	.[Finish]	-	.[Length]	.[Spindle center]	\$743.00
Header Assembly w/Stop Prep	2860-3572HL/S	.[Finish]	-	.[Length]	.[Spindle center]	\$743.00
Screw Pack Header	2860-MS-HDR	.[Finish]	-	-	-	\$63.00
Screw Pack Center Pivot	2860-MS-CP	.[Finish]	-	-	-	\$63.00
Screw Pack Offset Pivot	2860-MS-OP	.[Finish]	-	-	-	\$63.00
Spindle Plate - 2-3/4"	2860-11A	.[Finish]	-	-	-	\$98.00
Spindle Plate - 3-3/4"	2860-11B	.[Finish]	-	-	-	\$98.00
Arm and Tube	2860-78	.[Finish]	-	-	-	\$260.00
Rod	2860-82	.[Finish]	-	-	-	\$149.00
Pivot Body	2860-107	-	-	-	-	\$86.00
Pivot Post	2860-110	-	-	-	-	\$68.00
Bottom Pivot Plate	2860-117	-	-	-	-	\$68.00
Slide	2860-168	-	-	-	-	\$50.00
Mounting Bracket - 2-3/4"	2860-275	-	-	-	-	\$135.00
Header Endcaps	2860-334	.[Finish]	-	-	-	\$55.00
End Cap	2860-334-2	.[Finish]	-	-	-	\$98.00
Mounting Bracket - 3-3/4"	2860-375	-	-	-	-	\$130.00
Breakaway Door Stop	2860-384B	-	-	-	-	\$192.00
Fixed Door Stop	2860-384F	-	-	-	-	\$93.00
Cable/Parts Bag	2860-518	-	-	-	-	\$118.00
Header - Extrusion Only	2860-572	.[Finish]	-	.[Length]	-	\$70.00/ft
Header Only	2860-572HL	.[Finish]	-	.[Length]	.[Spindle center]	\$597.00
Header Only w/Stop Prep	2860-572HL/S	.[Finish]	-	.[Length]	.[Spindle center]	\$597.00
Rear Mount Bracket	2860-3018	-	-	-	-	\$130.00
Bottom Pivot Assembly	2860-3107	-	-	-	-	\$208.00
☞ Motor Gearbox (Std Force)	2860-3454	-	.[Handing]	-	-	\$2,940.00
Control Box	2860-3462	-	-	-	-	\$1,918.00

☞ Handed

9130 Series	Specify				Price
	Part number	Finish	Handing	Length	Anodized
Standard Arm	9130-3077T	.[Finish]	-	-	\$134.00
Standard Arm w/Track	9130-3077PLCM	.[Finish]	-	-	\$292.00
Track	9130-3038	.[Finish]	-	-	\$83.00
Metal Cover	9130-72MC	.[Finish]	-	.[Length]	\$206.00
Full Metal Cover	9130-72FC	.[Finish]	-	.[Length]	\$318.00
Screw Pack Header	9130-MS-HDR	.[Finish]	-	-	\$28.00
Screw Pack Pull Arm (includes -3034)	9130-MS-PULL	.[Finish]	-	-	\$28.00
Track End Cap	9130-73	-	-	-	\$12.00
Cover Insert	9130-163	.[Finish]	-	-	\$14.00
Cover End Cap Insert	9130-163-1	-	-	-	\$14.00
Cover End Cap	9130-334	-	-	-	\$44.00
24v SO Kit	9130-360	-	-	-	\$28.00
Mounting Bracket	9130-3018	-	-	-	\$167.00
Track Roller	9130-3034	-	-	-	\$39.00
Switch Bracket 29"	9130-3351-1	-	-	-	\$76.00
Switch Bracket 41"	9130-3351-2	-	-	-	\$76.00
Switch Bracket 51"	9130-3351-3	-	-	-	\$76.00
Motor Gearbox Assembly	9130-3454	-	-	-	\$2,111.00
Motor Gearbox Assembly w/Switch	9130-3454S	-	-	-	\$2,111.00
Standard Control Box	9130-3462SC	-	-	-	\$1,452.00
A/C Power Cable - 29"	9130-3498-2A	-	-	-	\$44.00
A/C Power Cable - 42"	9130-3498-2B	-	-	-	\$44.00
A/C Power Cable - 52"	9130-3498-2C	-	-	-	\$44.00
Box and Instruction Sheet	9130-Rebox Kit	-	-	-	\$7.00

9140 Series	Specify				Price
	Part number	Finish	Handing	Length	Anodized
Regular Arm	9140-3077	.[Finish]	-	-	\$134.00
Long Arm	9140-3077L	.[Finish]	-	-	\$139.00
Metal Cover	9140-72MC	.[Finish]	-	.[Length]	\$206.00
Full Metal Cover	9140-72FC	.[Finish]	-	.[Length]	\$318.00
Screw Pack Header	9140-MS-HDR	.[Finish]	-	-	\$28.00
Screw Pack Push Arm	9140-MS-PUSH	.[Finish]	-	-	\$28.00
Main Arm	9140-77	.[Finish]	-	-	\$134.00
Rod	9140-79	.[Finish]	-	-	\$33.00
Long Rod	9140-79LR	.[Finish]	-	-	\$50.00
Cover Insert	9140-163	.[Finish]	-	-	\$14.00
Cover End Cap Insert	9140-163-1	-	-	-	\$14.00
Cover End Cap	9140-334	-	-	-	\$44.00
Mounting Bracket	9140-3018	-	-	-	\$167.00
Switch Bracket 29"	9140-3351-1	-	-	-	\$76.00
Switch Bracket 41"	9140-3351-2	-	-	-	\$76.00

Handed

1000 SERIES
 4000 SERIES
 CONCEALED
 FIRE/LIFE SAFETY
 HIGH SECURITY
 AUTO OPERATORS
 ACTUATORS, ACCESSORIES
 MISC.

PARTS AND ACCESSORIES

Anodized

628 Aluminum (ANCLR)
710 Dark Bronze (ANDKB)

Handing

RH Right hand
LH Left hand

Dimensions

Dimensions should be written in inches and fractions of an inch with a hyphen separating the whole number from the fraction. Example: 46-1/2.

9140 Series	Specify				Price
	Part number	Finish	Handing	Length	Anodized
Switch Bracket 51"	9140-3351-3	-	-	.[Length]	\$76.00
Motor Gearbox Assembly	9140-3454	-	-	.[Length]	\$2,111.00
Motor Gearbox Assembly w/Switch	9140-3454S	-	-	.[Length]	\$2,111.00
Standard Control Box	9140-3462SC	-	-	.[Length]	\$1,452.00
A/C Power Cable - 29"	9140-3498-2A	-	-	.[Length]	\$44.00
A/C Power Cable - 42"	9140-3498-2B	-	-	.[Length]	\$44.00
A/C Power Cable - 52"	9140-3498-2C	-	-	.[Length]	\$44.00
Box and Instruction Sheet	9140-Rebox Kit	-	-	.[Length]	\$7.00

9150 Series	Specify				Price
	Part number	Finish	Handing	Length	Anodized
Regular Arm	9150-3077	.[Finish]	-	.[Length]	\$267.00
Long Arm	9150-3077L	.[Finish]	-	.[Length]	\$279.00
Metal Cover	9150-72MC	.[Finish]	-	.[Length]	\$318.00
Screw Pack Header	9150-MS-HDR	.[Finish]	-	.[Length]	\$28.00
Screw Pack Pull Arm	9150-MS-PULL	.[Finish]	-	.[Length]	\$28.00
Screw Pack Push Arm	9150-MS-PUSH	.[Finish]	-	.[Length]	\$28.00
Main Arm	9150-77	.[Finish]	-	.[Length]	\$134.00
Rod	9150-79	.[Finish]	-	.[Length]	\$33.00
Long Rod	9150-79LR	.[Finish]	-	.[Length]	\$50.00
Cover Insert	9150-163	.[Finish]	-	.[Length]	\$14.00
Cover End Cap Insert	9150-163-1	-	-	.[Length]	\$14.00
Cover End Cap	9150-334	-	-	.[Length]	\$44.00
24v SO Kit	9150-360	-	-	.[Length]	\$28.00
Mounting Bracket	9150-3018	-	-	.[Length]	\$167.00
Switch Bracket 29"	9150-3351-1	-	-	.[Length]	\$76.00
Switch Bracket 41"	9150-3351-2	-	-	.[Length]	\$76.00
Switch Bracket 51"	9150-3351-3	-	-	.[Length]	\$76.00
Motor Gearbox Assembly	9150-3454	-	-	.[Length]	\$2,111.00
Motor Gearbox Assembly w/Switch	9150-3454S	-	-	.[Length]	\$2,111.00
Standard Control Box	9150-3462SC	-	-	.[Length]	\$1,452.00
A/C Power Cable	9150-3498-2A	-	-	.[Length]	\$44.00
Box and Instruction Sheet	9150-Rebox Kit	-	-	.[Length]	\$7.00

Handed

9530 Series	Specify					Price
	Part number	Finish	Handing	Length	Spindle center	Anodized
☞ Standard Arm	9530-3077T	.[Finish]	.[Handing]	-	-	\$310.00
☞ Standard Arm w/Track	9530-3077PLCM	.[Finish]	.[Handing]	-	-	\$447.00
Track	9530-3038	.[Finish]	-	-	-	\$93.00
Header Assembly	9530-3572HL	.[Finish]	-	.[Length]	.[Spindle center]	\$440.00
Double Door Header Assembly	9530-3572DD	.[Finish]	-	.[Length]	-	\$748.00
Screw Pack	9530-MS-HDR	.[Finish]	-	-	-	\$31.00
Screw Pack Pull Arm	9530-MS-PULL	.[Finish]	-	-	-	\$31.00
Spindle Plate - 2-3/4"	9530-11A	.[Finish]	-	-	-	\$98.00
Spindle Plate - 3-3/4"	9530-11B	.[Finish]	-	-	-	\$98.00
Blank Filler Plate	9530-12	.[Finish]	-	.[Length]	.[Spindle center]	\$118.00
Mounting Plate (length required; add 3-1/2" if using angled brackets)	9530-18	.[Finish]	-	.[Length]	-	\$98.00
Track End Cap	9530-73	-	-	-	-	\$14.00
Mounting Bracket - 2-3/4"	9530-275	-	-	-	-	\$130.00
Header Endcap	9530-334	-	-	-	-	\$55.00
Angled Bracket	9530-334-1	.[Finish]	-	-	-	\$207.00
End Dress Plate	9530-334-2	.[Finish]	-	-	-	\$98.00
Mounting Bracket - 3-3/4"	9530-375	-	-	-	-	\$130.00
Dress Plate - Extrusion Only	9530-511	.[Finish]	-	.[Length]	-	\$26.00/ft
Cable/Parts Bag	9530-518	-	-	-	-	\$118.00
Header - Extrusion Only	9530-572	.[Finish]	-	.[Length]	-	\$70.00/ft
Header Only	9530-572HL	.[Finish]	-	.[Length]	.[Spindle center]	\$282.00
Double Door Header Only	9530-572DD	.[Finish]	-	.[Length]	.[Spindle center]	\$597.00
Rear Mount Bracket	9530-3018	-	-	-	-	\$130.00
Track Roller	9530-3034	-	-	-	-	\$43.00
☞ Motor Gearbox (Std Force)	9530-3454	-	.[Handing]	-	-	\$2,940.00
Controller	9530-3462	-	-	-	-	\$1,918.00

9540 Series	Specify					Price
	Part number	Finish	Handing	Length	Spindle center	Anodized
☞ Regular Arm	9540-3077	.[Finish]	.[Handing]	-	-	\$298.00
☞ Long Arm	9540-3077L	.[Finish]	.[Handing]	-	-	\$310.00
Header Assembly	9540-3572HL	.[Finish]	-	.[Length]	.[Spindle center]	\$440.00
Double Door Header Assembly	9540-3572DD	.[Finish]	-	.[Length]	.[Spindle center]	\$748.00
Screw Pack Header	9540-MS-HDR	.[Finish]	-	-	-	\$31.00
Screw Pack Push Arm	9540-MS-PUSH	.[Finish]	-	-	-	\$31.00
Spindle Plate - 2-3/4"	9540-11A	.[Finish]	-	-	-	\$98.00
Spindle Plate - 3-3/4"	9540-11B	.[Finish]	-	-	-	\$98.00
Blank Filler Plate	9540-12	.[Finish]	-	.[Length]	.[Spindle center]	\$118.00
Mounting Plate (Length Required; Add 3-1/2" if Using Angled Brackets)	9540-18	.[Finish]	-	.[Length]	-	\$98.00/ft
☞ Main Arm	9540-77	.[Finish]	.[Handing]	-	-	\$247.00

☞ Handed

PARTS AND ACCESSORIES

Anodized
 628 Aluminum (ANCLR)
 710 Dark Bronze (ANDKB)

Handing
 RH Right hand
 LH Left hand

Dimensions
 Dimensions should be written in inches and fractions of an inch with a hyphen separating the whole number from the fraction. Example: 46-1/2.

9540 Series	Specify					Price
	Part number	Finish	Handing	Length	Spindle center	Anodized
Rod and Shoe	9540-79	.[Finish]	-	-	-	\$73.00
Long Rod	9540-79LR	.[Finish]	-	-	-	\$73.00
Rod	9540-82	.[Finish]	-	-	-	\$50.00
Long Rod	9540-82L	.[Finish]	-	-	-	\$50.00
Mounting Bracket - 2-3/4"	9540-275	-	-	-	-	\$130.00
Header Endcap	9540-334	-	-	-	-	\$55.00
Angled Bracket	9540-334-1	.[Finish]	-	-	-	\$207.00
End Dress Plate	9540-334-2	.[Finish]	-	-	-	\$98.00
Mounting Bracket - 3-3/4"	9540-375	-	-	-	-	\$130.00
Dress Plate - Extrusion Only	9540-511	.[Finish]	-	.[Length]	-	\$26.00/ft
Cable/Parts Bag	9540-518	-	-	-	-	\$118.00
Header - Extrusion Only	9540-572	.[Finish]	-	.[Length]	-	\$70.00/ft
Header Only	9540-572HL	.[Finish]	-	.[Length]	.[Spindle center]	\$282.00
Double Door Header Only	9540-572DD	.[Finish]	-	.[Length]	.[Spindle center]	\$597.00
Rear Mount Bracket	9540-3018	-	-	-	-	\$130.00
☞ Motor Gearbox (Std Force)	9540-3454	-	.[Handing]	-	-	\$2,940.00
Controller	9540-3462	-	-	-	-	\$1,918.00
Arm/Spindle Plate 2.75" with DPS	3077-11A	.[Finish]	.[Handing]	-	-	\$470.00
Arm/Spindle Plate 3.75" with DPS	3077-11B	.[Finish]	.[Handing]	-	-	\$470.00

9550 Series	Specify					Price
	Part number	Finish	Handing	Length	Spindle center	Anodized
☞ Regular Arm	9540-3077	.[Finish]	.[Handing]	-	-	\$298.00
☞ Long Arm	9540-3077L	.[Finish]	.[Handing]	-	-	\$310.00
☞ Standard Arm	9530-3077T	.[Finish]	.[Handing]	-	-	\$310.00
☞ Standard Arm w/Track	9530-3077PLCM	.[Finish]	.[Handing]	-	-	\$447.00
Track	9550-3038	.[Finish]	-	-	-	\$93.00
Header Assembly	9550-3572HL	.[Finish]	-	.[Length]	.[Spindle center]	\$748.00
Screw Pack Header	9550-MS-HDR	.[Finish]	-	-	-	\$63.00
Screw Pack Pull Arm	9550-MS-PULL	.[Finish]	-	-	-	\$63.00
Screw Pack Push	9550-MS-PUSH	.[Finish]	-	-	-	\$63.00
Spindle Plate - 2-3/4"	9550-11A	.[Finish]	-	-	-	\$98.00
Spindle Plate - 3-3/4"	9550-11B	.[Finish]	-	-	-	\$98.00

☞ Handed

9550 Series	Specify					Price
	Part number	Finish	Handing	Length	Spindle center	Anodized
Mounting Plate (Length Required; Add 3-1/2" if Using Angled Brackets)	9550-18	.[Finish]	-	.[Length]	-	\$98.00/ft
☞ Main Arm	9550-77	.[Finish]	.[Handing]	-	-	\$247.00
Rod and Shoe	9550-79	.[Finish]	-	-	-	\$73.00
Long Rod and Shoe	9550-79LR	.[Finish]	-	-	-	\$73.00
Rod	9550-82	.[Finish]	-	-	-	\$50.00
Long Rod	9550-82L	.[Finish]	-	-	-	\$50.00
Mounting Bracket - 2-3/4"	9550-275	-	-	-	-	\$130.00
Header Endcap	9550-334	-	-	-	-	\$55.00
Angled Bracket	9550-334-1	.[Finish]	-	-	-	\$207.00
End Dress Plate	9550-334-2	.[Finish]	-	-	-	\$98.00
Mounting Bracket - 3-3/4"	9550-375	-	-	-	-	\$130.00
Cable/Parts Bag	9550-518	-	-	-	-	\$118.00
Header - Extrusion Only	9550-572	.[Finish]	-	.[Length]	-	\$70.00/ft
Header Only	9550-572HL	.[Finish]	-	.[Length]	.[Spindle center]	\$564.00
Companion Cable	9550-982	-	-	-	-	\$86.00
Rear Mount Bracket	9550-3018	-	-	-	-	\$130.00
Track Roller	9550-3034	-	-	-	-	\$43.00
☞ Motor Gearbox (Std Force)	9550-3454	-	.[Handing]	-	-	\$2,940.00
Controller	9550-3462	-	-	-	-	\$1,918.00

9560 Series	Specify					Price
	Part number	Finish	Handing	Length	Spindle center	Anodized
☞ Regular Arm	9540-3077	.[Finish]	.[Handing]	-	-	\$298.00
☞ Long Arm	9540-3077L	.[Finish]	.[Handing]	-	-	\$310.00
☞ Standard Arm	9530-3077T	.[Finish]	.[Handing]	-	-	\$310.00
☞ Standard Arm w/Track	9530-3077PLCM	.[Finish]	.[Handing]	-	-	\$447.00
Track	9560-3038	.[Finish]	-	-	-	\$90.00
Header Assembly	9560-3572HL	.[Finish]	-	.[Length]	.[Spindle center]	\$748.00
Screw Pack Header	9550-MS-HDR	.[Finish]	-	-	-	\$63.00
Screw Pack Pull Arm	9550-MS-PULL	.[Finish]	-	-	-	\$63.00
Screw Pack Push	9550-MS-PUSH	.[Finish]	-	-	-	\$63.00
Spindle Plate - 2-3/4"	9560-11A	.[Finish]	-	-	-	\$98.00
Spindle Plate - 3-3/4"	9560-11B	.[Finish]	-	-	-	\$98.00
Mounting Plate (Length Required; Add 3-1/2" if Using Angled Brackets)	9560-18	.[Finish]	-	.[Length]	-	\$98.00/ft
☞ Main Arm	9560-77	.[Finish]	.[Handing]	-	-	\$247.00
Rod and Shoe	9560-79	.[Finish]	-	-	-	\$73.00
Long Rod and Shoe	9560-79LR	.[Finish]	-	-	-	\$73.00
Rod	9560-82	.[Finish]	-	-	-	\$50.00
Long Rod	9560-82L	.[Finish]	-	-	-	\$50.00
Mounting Bracket - 2-3/4"	9560-275	-	-	-	-	\$130.00
Header Endcap	9560-334	-	-	-	-	\$55.00

☞ Handed

PARTS AND ACCESSORIES

Anodized

628 Aluminum (ANCLR)
710 Dark Bronze (ANDKB)

Handing

RH Right hand
LH Left hand

Dimensions











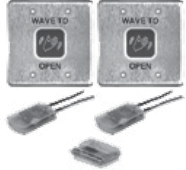

Dimensions should be written in inches and fractions of an inch with a hyphen separating the whole number from the fraction. Example: 46-1/2.

9560 Series	Specify					Price
	Part number	Finish	Handing	Length	Spindle center	Anodized
Angled Bracket	9560-334-1	.[Finish]	-	-	-	\$207.00
End Dress Plate	9560-334-2	.[Finish]	-	.[Length]	-	\$98.00
Mounting Bracket - 3-3/4"	9560-375	-	-	-	-	\$130.00
Cable/Parts Bag	9560-518	-	-	-	-	\$120.00
Header - Extrusion Only	9560-572	.[Finish]	-	.[Length]	-	\$70.00/ft
Header Only	9560-572HL	.[Finish]	-	.[Length]	.[Spindle center]	\$564.00
Rear Mount Bracket	9560-3018	-	-	-	-	\$130.00
Track Roller	9560-3034	-	-	-	-	\$43.00
 Motor Gearbox (Std Force)	9560-3454	-	.[Handing]	-	-	\$2,940.00
Controller	9560-3462	-	-	-	-	\$1,918.00

 Handed

this page intentionally blank

8310 SERIES TOUCHLESS ACTUATORS

<p>8310-810D</p> 	<p>8310-3810DW</p> 	<p>8310-810DA</p> 	<p>8310-810S</p> 
<p>8310-810SA</p> 	<p>8310-810R</p> 	<p>8310-3810RW</p> 	<p>8310-810RA</p> 
<p>8310-813</p> 	<p>8310-3813W</p> 	<p>8310-813WH</p> 	<p>8310-813R</p> 
<p>8310-3813RW</p> 	<p>8310-813RWH</p> 		

1000 SERIES

4000 SERIES

CONCEALED

FIRE/LIFE SAFETY

HIGH SECURITY

AUTO OPERATORS

ACTUATORS, ACCESSORIES

MISC.

8310 SERIES TOUCHLESS ACTUATORS

Touchless actuator, double gang, stainless steel - heavy duty		
Wave icon and text	Specify	Price
Touchless actuator, double gang, wave icon and text	8310-810D	\$860.00
Touchless actuator, double gang, wave icon and text kit ▪ (2) 8310-810D Touchless actuators, (1) 8310-880 Receiver, (2) 8310-885 Transmitters	8310-3810DW	\$2,285.00
Wheelchair icon and text	Specify	Price
Touchless actuator, double gang, wheelchair icon and text	8310-810DA	\$860.00

Touchless actuator, single gang, stainless steel - heavy duty		
Wave icon and text	Specify	Price
Touchless actuator, single gang, wave icon and text	8310-810S	\$792.00
Wheelchair icon and text	Specify	Price
Touchless actuator, single gang, wheelchair icon and text	8310-810SA	\$792.00

Touchless actuator, round, stainless steel - heavy duty		
Wave icon and text	Specify	Price
Touchless actuator, round, wave icon and text	8310-810R	\$860.00
Touchless actuator, round, wave icon and text kit ▪ (2) 8310-810R Touchless actuators, (1) 8310-880 Receiver, (2) 8310-885 Transmitters	8310-3810RW	\$2,285.00
Wheelchair icon and text	Specify	Price
Touchless actuator, round, wheelchair icon and text	8310-810RA	\$860.00

Touchless actuator, single and double gang - standard duty		
Wave icon and text, black	Specify	Price
Touchless actuator, black single and double gang, wave icon and text	8310-813	\$582.00
Touchless actuator, black single and double gang, wave icon and text kit ▪ (2) 8310-813 Touchless actuators, (1) 8310-880 Receiver, (2) 8310-885 Transmitters	8310-3813W	\$1,729.00
Wave icon and text, white	Specify	Price
Touchless actuator, white single and double gang, wave icon and text	8310-813WH	\$617.00

Touchless actuator, round - standard duty		
Wave icon and text, black	Specify	Price
Touchless actuator, black round, wave icon and text	8310-813R	\$582.00
Touchless actuator, black round, wave icon and text kit ▪ (2) 8310-813R Touchless actuators, (1) 8310-880 Receiver, (2) 8310-885 Transmitters	8310-3813RW	\$1,729.00
Wave icon and text, white	Specify	Price
Touchless actuator, white round, wave icon and text	8310-813RWH	\$617.00

8310 SERIES TOUCHLESS ACTUATORS

1000 SERIES

4000 SERIES

CONCEALED

FIRE/LIFE SAFETY

HIGH SECURITY

AUTO OPERATORS

ACTUATORS, ACCESSORIES

MISC.

<p>8310-813J</p> 	<p>8310-3813JW</p> 	<p>8310-813JWH</p> 	<p>8310-815</p> 
<p>8310-816S</p> 	<p>8310-816SL</p> 	<p>8310-816R</p> 	<p>8310-816RL</p> 
<p>8310-880</p> 	<p>8310-881</p> 	<p>8310-882</p> 	<p>8310-883</p> 
<p>8310-884</p> 	<p>8310-885</p> 	<p>8310-886</p> 	<p>8310-2210</p> 
<p>8310-2310</p> 	<p>8310-2320</p> 	<p>8310-2330</p> 	<p>8310-883</p> 

8310 SERIES TOUCHLESS ACTUATORS

Touchless actuator, jamb - standard duty		
Wave icon and text, black	Specify	Price
Touchless actuator, black jamb, wave icon and text. Should be installed with a 8310-819SJ box.	8310-813J	\$582.00
Touchless actuator, black jamb, wave icon and text kit <ul style="list-style-type: none"> ▪ (2) 1-3/4" X 4-1/2" 8310-813J Touchless actuators, (1) 8310-865 Receiver , (2) 8310-885 Transmitters ▪ (2) 8310-819SJ boxes Note: 8310-813J actuators will not fit in the 8310-819F or 8310-819S boxes	8310-3813JW	\$1,729.00
Wave icon and text, white	Specify	
Touchless actuator, white jamb, wave icon and text. Should be installed with a 8310-819SJ box.	8310-813JWH	\$617.00
Touchless actuator, surface mount box - heavy duty		
Wave icon and text, black	Specify	Price
Touchless actuator, stainless steel enclosed box, wave icon and text	8310-815	\$759.00
Touchless actuator, double gang, stainless steel - proximity detection		
Wave icon and text	Specify	Price
Touchless actuator, double gang, wave icon and text, proximity	8310-816S	\$433.00
Wheelchair icon and wave icon, no text	Specify	Price
Touchless actuator, double gang, icons only, proximity	8310-816SL	\$433.00
Touchless actuator, round, stainless steel - proximity detection		
Wave icon and text	Specify	Price
Touchless actuator, round, wave icon and text, proximity	8310-816R	\$433.00
Wheelchair icon and wave icon, no text	Specify	Price
Touchless actuator, round, icons only, proximity	8310-816RL	\$433.00
Battery powered touchless actuators		
Wave icon and text, stainless steel	Specify	Price
Touchless actuator, single gang, wave icon and text	8310-2310	\$446.00
Touchless actuator, double gang, wave icon and text	8310-2320	\$451.00
Touchless actuator, narrow, wave icon and text	8310-2330	\$446.00
Touchless actuator, round, wave icon and text	8310-2340	\$451.00

8310 SERIES TOUCHLESS ACTUATORS

Battery powered touchless actuators		
Accessibility icon and text, stainless steel	Specify	Price
Single gang kit <ul style="list-style-type: none"> ▪ 2 single gang, battery powered, touchless actuators with built-in transmitters (2) surface mount boxes (1) wireless receiver 	8310-2210	\$1,137.00

Touchless actuator transmitters and receivers		
Receiver	Specify	Price
900 MHz Receiver	8310-880	\$181.00
Transmitters	Specify	Price
Handheld transmitter, 1 button; compatible with 8310-880 receiver	8310-881	\$185.00
Handheld transmitter, 2 button; compatible with 8310-880 receiver	8310-882	\$221.00
Handheld transmitter, 3 button; compatible with 8310-880 receiver	8310-883	\$228.00
Handheld transmitter, 4 button; compatible with 8310-880 receiver	8310-884	\$234.00
Handheld transmitter, retrofit; compatible with 8310-880 receiver	8310-885	\$191.00
Handheld transmitter, hardwired; compatible with 8310-880 receiver	8310-886	\$185.00

 Handing required

1000 SERIES

4000 SERIES

CONCEALED

FIRE/LIFE SAFETY



HIGH SECURITY

AUTO OPERATORS

ACTUATORS, ACCESSORIES

MISC.

8310 SERIES RESTROOM KITS

Restroom kits		
Touchless restroom kit	Specify	Price
 <p>Touchless restroom kit</p> <ul style="list-style-type: none"> Advanced logic relay, 2 amp power supply, control box and transformer Wired touchless switch, "Wave to Lock", light ring, stainless faceplate Wired touchless switch, "Wave to Open", light ring double gang stainless steel faceplate Wired touchless switch, "Wave to Open", double gang stainless steel faceplate Electric strike, Grade 2 ANSI, 3 faceplates Door position switch, surface 	8310-2410	\$2,700.00
Push plate restroom kit	Specify	Price
 <p>Push plate restroom kit</p> <ul style="list-style-type: none"> Advanced logic relay, 2 amp power supply, control box and transformer Combo push actuator, 2"x4", "Push to Open" and "Push to Lock", illuminated, flush mount Push plate actuator, 4-1/2", "Push to Open", illuminated Electric strike, Grade 2 ANSI, 3 faceplates Door position switch, surface 	8310-2420	\$2,100.00

8310 SERIES ACTUATORS

1000 SERIES

4000 SERIES

CONCEALED







FIRE/LIFE SAFETY

HIGH SECURITY

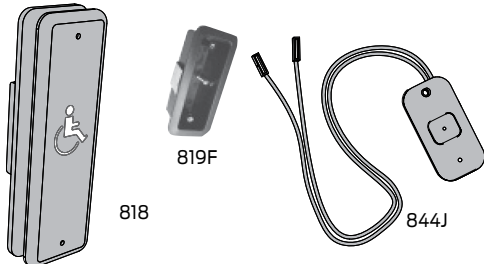
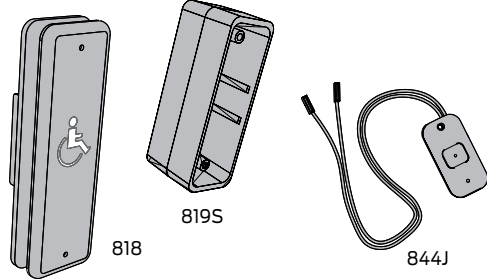

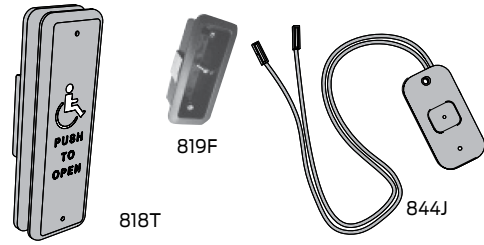
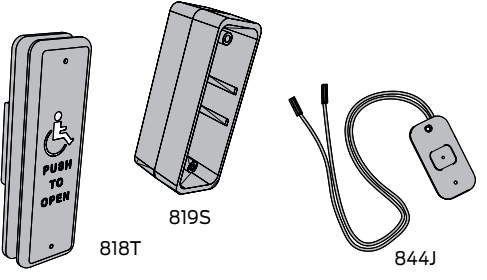
AUTO OPERATORS

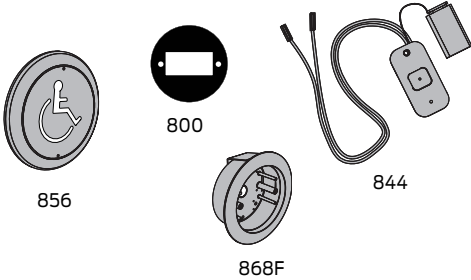
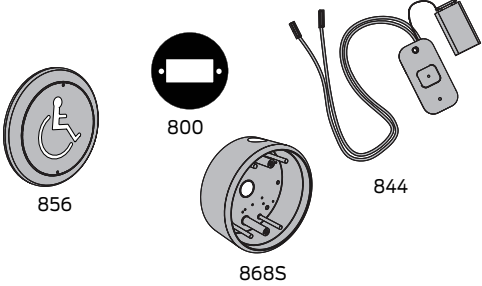

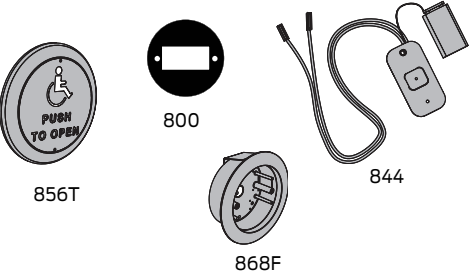
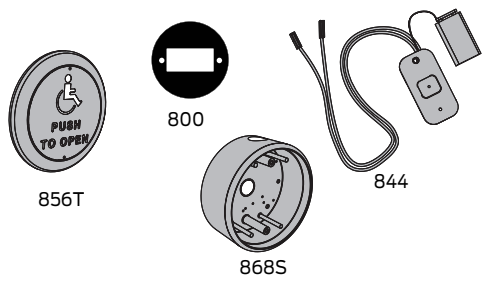
ACTUATORS, ACCESSORIES

MISC.

<p>8310-818</p> 	<p>8310-3818WF</p>  <p>818 819F 844J</p>	<p>8310-3818WS</p>  <p>818 819S 844J</p>
<p>8310-818T</p> 	<p>8310-3818TWF</p>  <p>818T 819F 844J</p>	<p>8310-3818TWS</p>  <p>818T 819S 844J</p>
<p>8310-856</p> 	<p>8310-3856WF</p>  <p>856 800 868F 844</p>	<p>8310-3856WS</p>  <p>856 800 868S 844</p>
<p>8310-856T</p> 	<p>8310-3856TWF</p>  <p>856T 800 868F 844</p>	<p>8310-3856TWS</p>  <p>856T 800 868S 844</p>

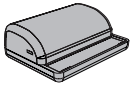
8310 SERIES ACTUATORS

Jamb mount actuator - 1-1/2" x 4-3/4" rectangle - interior installation only			
Logo only	Specify	Price	
Actuator, 1-1/2" x 4-3/4" rectangle, logo	8310-818	\$229.00	
Actuator, 1-1/2" x 4-3/4" rectangle, logo, wireless, flush mount <ul style="list-style-type: none"> (1) 8310-818 actuator, (1) 8310-844J transmitter, (1) 8310-819F flush box Requires 8310-865 receiver 	8310-3818WF	\$508.00	
Actuator, 1-1/2" x 4-3/4" rectangle, logo, wireless, surface mount <ul style="list-style-type: none"> (1) 8310-818 actuator, (1) 8310-844J transmitter, (1) 8310-819S surface box Requires 8310-865 receiver 	8310-3818WS	\$508.00	
Logo with text	Specify		
Actuator, 1-1/2" x 4-3/4" rectangle, logo, text	8310-818T	\$229.00	
Actuator, 1-1/2" x 4-3/4" rectangle, logo, text, wireless, flush mount <ul style="list-style-type: none"> (1) 8310-818T actuator, (1) 8310-844J transmitter, (1) 8310-819F flush box Requires 8310-865 receiver 	8310-3818TWF	\$508.00	
Actuator, 1-1/2" x 4-3/4" rectangle, logo, text, wireless, surface mount <ul style="list-style-type: none"> (1) 8310-818T actuator, (1) 8310-844J transmitter, (1) 8310-819S surface box Requires 8310-865 receiver 	8310-3818TWS	\$508.00	
Receiver	Specify		
Receiver, wireless, 1 channel, sequencing feature <ul style="list-style-type: none"> Used in conjunction with wireless transmitters 	8310-865	\$273.00	

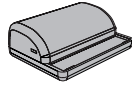
Wall mount actuator - 4-1/2" round			
Logo only	Specify	Price	
Actuator, 4-1/2" round, logo	8310-856	\$267.00	
Actuator, 4-1/2" round, logo, wireless, flush mount <ul style="list-style-type: none"> (1) 8310-856 actuator, (1) 8310-844 transmitter, (1) 8310-868F flush box, (1) 8310-800 weather ring Requires 8310-865 receiver 	8310-3856WF	\$706.00	
Actuator, 4-1/2" round, logo, wireless, surface mount <ul style="list-style-type: none"> (1) 8310-856 actuator, (1) 8310-844 transmitter, (1) 8310-868S surface box, (1) 8310-800 weather ring Requires 8310-865 receiver 	8310-3856WS	\$706.00	
Logo with text	Specify		
Actuator, 4-1/2" round, logo, text	8310-856T	\$267.00	
Actuator, 4-1/2" round, logo, text, wireless, flush <ul style="list-style-type: none"> (1) 8310-856T actuator, (1) 8310-844 transmitter, (1) 8310-868F flush box, (1) 8310-800 weather ring Requires 8310-865 receiver 	8310-3856TWF	\$706.00	
Actuator, 4-1/2" round, logo, text, wireless, surface mount <ul style="list-style-type: none"> (1) 8310-856T actuator, (1) 8310-844 transmitter, (1) 8310-868S surface box, (1) 8310-800 weather ring Requires 8310-865 receiver 	8310-3856TWS	\$706.00	
Receiver	Specify		
Receiver, wireless, 1 channel, sequencing feature <ul style="list-style-type: none"> Used in conjunction with wireless transmitters 	8310-865	\$273.00	

8310 SERIES ACTUATORS

1000 SERIES

4000 SERIES

CONCEALED





FIRE/LIFE SAFETY

HIGH SECURITY



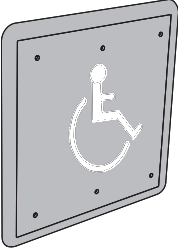
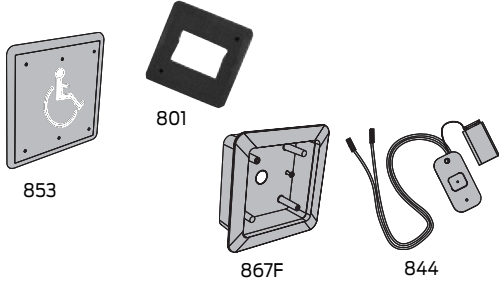
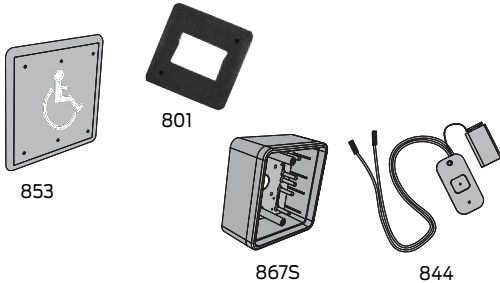
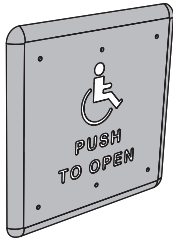
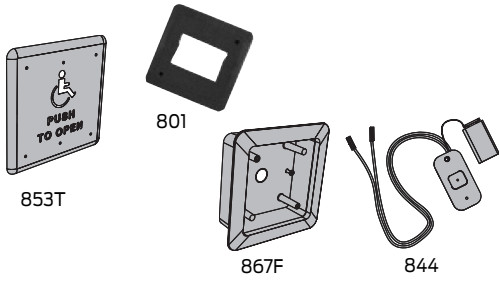
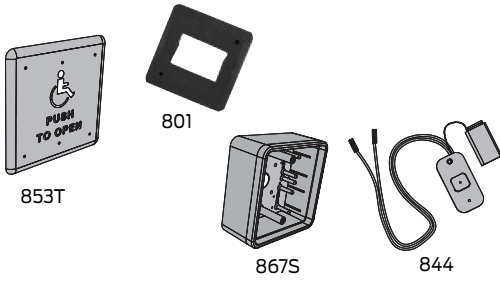

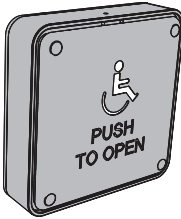
AUTO OPERATORS

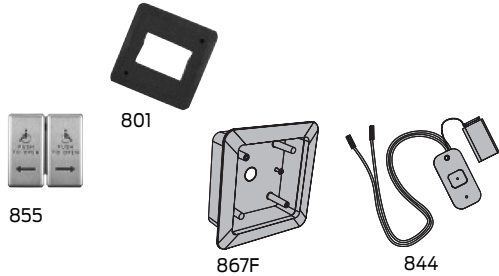
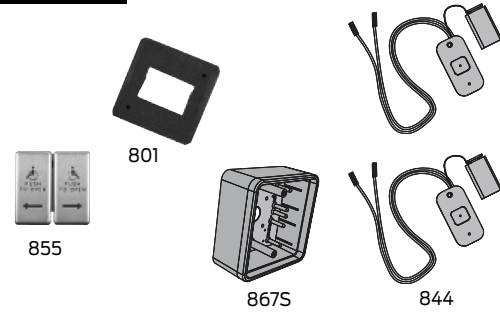
ACTUATORS, ACCESSORIES

MISC.

<p>8310-853</p> 	<p>8310-3853WF</p> 	<p>8310-3853WS</p> 
<p>8310-853T</p> 	<p>8310-3853TWF</p> 	<p>8310-3853TWS</p> 
<p>8310-853WP</p> 	<p>8310-853TWP</p> 	
<p>8310-855</p> 	<p>8310-3855WF</p> 	<p>8310-3855WS</p> 

8310 SERIES ACTUATORS

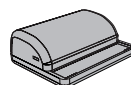
Wall mount actuator - 4-3/4" square			
Logo only	Specify	Price	
Actuator, 4-3/4" square, logo	8310-853	\$334.00	 8310-853  8310-853WP
Actuator, 4-3/4" square, logo, wireless, surface mount 8310-853 actuator with slender, assembled surface mount box and transmitter.	8310-853WP	\$897.00	
Actuator, 4-3/4" square, logo, wireless, flush mount ▪ (1) 8310-853 actuator, (1) 8310-844 transmitter, (1) 8310-867F flush box, (1) 8310-801 weather ring ▪ Requires 8310-865 receiver	8310-3853WF	\$805.00	
Actuator, 4-3/4" square, logo, wireless, surface mount ▪ (1) 8310-853 actuator, (1) 8310-844 transmitter, (1) 8310-867S surface box, (1) 8310-801 weather ring ▪ Requires 8310-865 receiver	8310-3853WS	\$805.00	
Logo with text	Specify		
Actuator, 4-3/4" square, logo, text	8310-853T	\$334.00	 8310-853T  8310-853TWP
Actuator, 4-3/4" square, active logo, text	8310-853TA	\$334.00	
Actuator, 4-3/4" square, logo, text, wireless, surface mount ▪ 8310-853T actuator with slender, assembled surface mount box and transmitter.	8310-853TWP	\$897.00	
Actuator, 4-3/4" square, logo, text, wireless, flush mount ▪ (1) 8310-853T actuator, (1) 8310-844 transmitter, (1) 8310-867F flush box, (1) 8310-801 weather ring ▪ Requires 8310-865 receiver	8310-3853TWF	\$805.00	
Actuator, 4-3/4" square, logo, text, wireless, surface mount ▪ (1) 8310-853T actuator, (1) 8310-844 transmitter, (1) 8310-867S surface box, (1) 8310-801 weather ring ▪ Requires 8310-865 receiver	8310-3853TWS	\$805.00	
Receiver	Specify		
Receiver, wireless, 1 channel, sequencing feature ▪ Used in conjunction with wireless transmitters	8310-865	\$273.00	

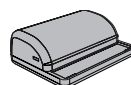
Wall mount actuator - 4-3/4" square, dual vestibule			
Logo with text	Specify	Price	
Actuator, 4-3/4" square, logo, dual vestibule	8310-855	\$526.00	
Actuator, 4-3/4" square, logo, dual vestibule, wireless, flush mount ▪ (1) 8310-855 dual-vestibule actuator, (2) 8310-844 transmitters, (1) 8310-867F flush box, (1) 8310-801 weather ring ▪ Requires 8310-865 receiver	8310-3855WF	\$1,232.00	
Actuator, 4-3/4" square, logo, dual vestibule, wireless, surface mount ▪ (1) 8310-855 dual-vestibule actuator, (2) 8310-844 transmitters, (1) 8310-867S surface box, (1) 8310-801 weather ring ▪ Requires 8310-865 receiver	8310-3855WS	\$1,232.00	
Receiver, wireless, 1 channel, sequencing feature ▪ Used in conjunction with wireless transmitters	8310-865	\$273.00	

8310 SERIES ACTUATORS

1000 SERIES

4000 SERIES

CONCEALED





FIRE/LIFE SAFETY

HIGH SECURITY

AUTO OPERATORS

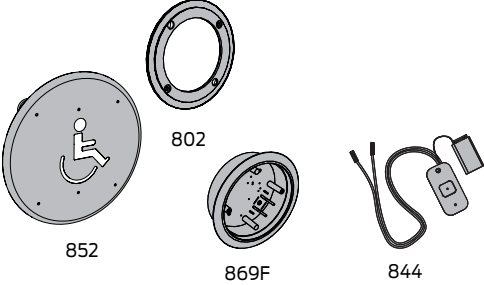
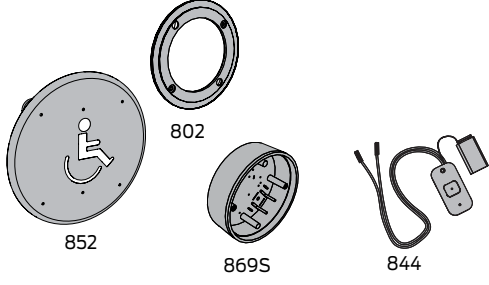
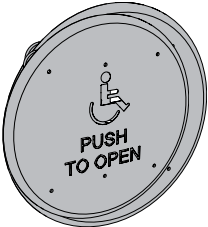
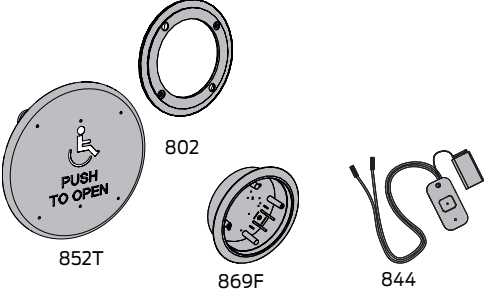
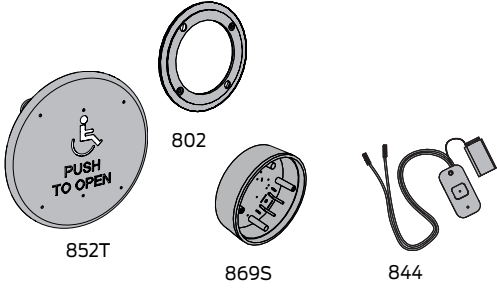
ACTUATORS, ACCESSORIES

MISC.

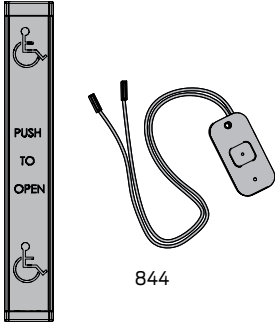
<p>8310-852</p> 	<p>8310-3852WF</p>  <p>852 802 869F 844</p>	<p>8310-3852WS</p>  <p>852 802 869S 844</p>
<p>8310-852T</p> 	<p>8310-3852TWF</p>  <p>852T 802 869F 844</p>	<p>8310-3852TWS</p>  <p>852T 802 869S 844</p>
<p>8310-852WP</p> 	<p>8310-852TWP</p> 	
<p>8310-836T</p> 	<p>8310-836TW</p>  <p>836T 844</p>	

8310 SERIES ACTUATORS

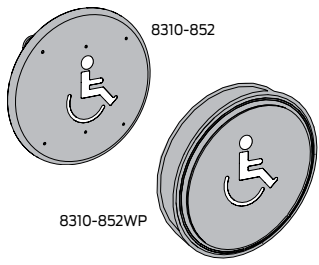
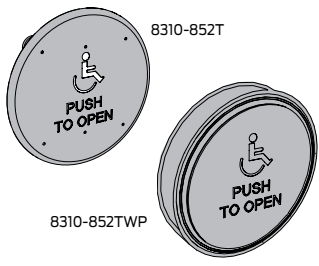
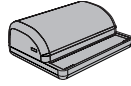
Wall mount actuator - 6" round			
Logo only	Specify	Price	
Actuator, 6" round, logo	8310-852	\$347.00	
Actuator, 6" round, logo, wireless, surface mount <ul style="list-style-type: none"> 8310-852 actuator with slender, assembled surface mount box and transmitter 	8310-852WP	\$897.00	
Actuator, 6" round, logo, wireless, flush mount <ul style="list-style-type: none"> (1) 8310-852 actuator, (1) 8310-844 transmitter, (1) 8310-869F flush box, (1) 8310-802 weather ring Requires 8310-865 receiver 	8310-3852WF	\$805.00	
Actuator, 6" round, logo, wireless, surface mount <ul style="list-style-type: none"> (1) 8310-852 actuator, (1) 8310-844 transmitter, (1) 8310-869S surface box, (1) 8310-802 weather ring Requires 8310-865 receiver 	8310-3852WS	\$805.00	
Logo with text	Specify		
Actuator, 6" round, logo, text	8310-852T	\$347.00	
Actuator, 6" round, active logo, text	8310-852TA	\$347.00	
Actuator, 6" round, logo, text, wireless, surface mount <ul style="list-style-type: none"> 8310-852T actuator with slender, assembled surface mount box and transmitter 	8310-852TWP	\$897.00	
Actuator, 6" round, logo, text, wireless, flush mount <ul style="list-style-type: none"> (1) 8310-852T actuator, (1) 8310-844 transmitter, (1) 8310-869F flush box, (1) 8310-802 weather ring Requires 8310-865 receiver 	8310-3852TWF	\$805.00	
Actuator, 6" round, logo, text, wireless, surface mount <ul style="list-style-type: none"> (1) 8310-852T actuator, (1) 8310-844 transmitter, (1) 8310-869S surface box, (1) 8310-802 weather ring Requires 8310-865 receiver 	8310-3852TWS	\$805.00	
Receiver	Specify		
Receiver, wireless, 1 channel, sequencing feature <ul style="list-style-type: none"> Used in conjunction with wireless transmitters 	8310-865	\$273.00	

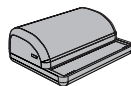
Specialty full length actuator			
Logo with text	Specify	Price	
Actuator, 36" x 6" full length, logo, text	8310-836T	\$1,257.00	
Actuator, 36" x 6" full length, logo, text, wireless <ul style="list-style-type: none"> (1) 8310-836T actuator, (1) 8310-844 transmitter Requires 8310-865 receiver 	8310-836TW	\$1,455.00	
Receiver	Specify		
Receiver, wireless, 1 channel, sequencing feature <ul style="list-style-type: none"> Used in conjunction with wireless transmitters 	8310-865	\$273.00	

8310 SERIES ACTUATOR PACKAGES

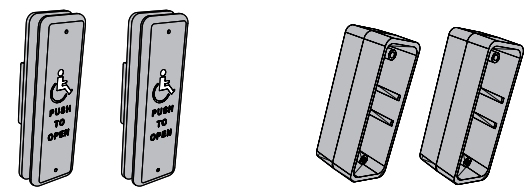
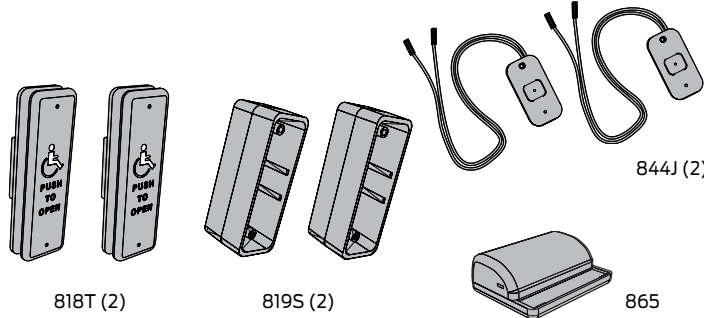
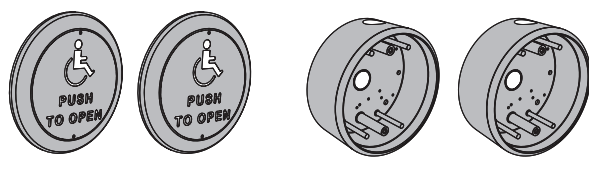
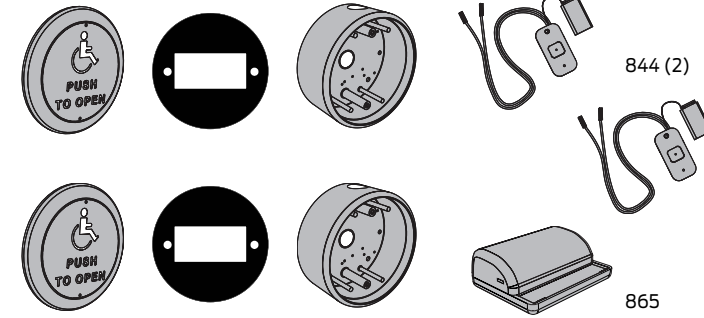
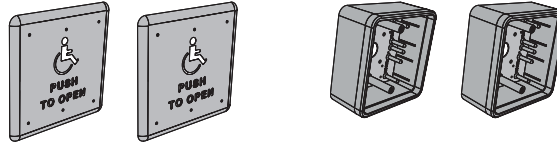
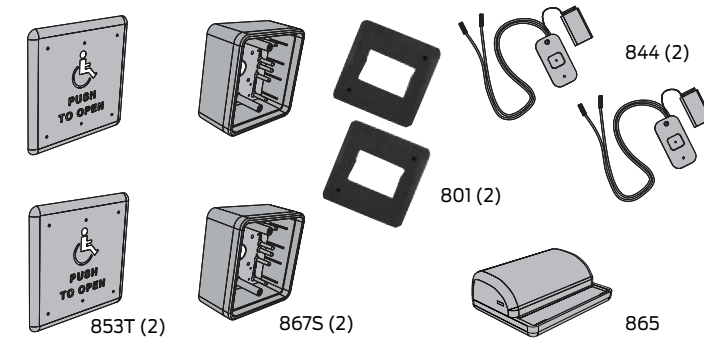
<p>8310-3822T</p>  <p>818T (2) 819S (2)</p>	<p>8310-3822TW</p>  <p>818T (2) 819S (2) 844J (2)</p> <p>865</p>
<p>8310-3860T</p>  <p>856T (2) 868S (2)</p>	<p>8310-3860TW</p>  <p>856T (2) 800 (2) 868S (2)</p> <p>844 (2)</p> <p>865</p>
<p>8310-3857T</p>  <p>853T (2) 867S (2)</p>	<p>8310-3857TW</p>  <p>853T (2) 867S (2) 801 (2)</p> <p>844 (2)</p> <p>865</p>

1000 SERIES

4000 SERIES

CONCEALED

FIRE/LIFE SAFETY

HIGH SECURITY

AUTO OPERATORS

ACTUATORS, ACCESSORIES



MISC.

8310 SERIES ACTUATOR PACKAGES

Actuator packages		
Jamb mount	Specify	Price
Actuator package, 1-1/2" x 4-3/4", jamb mount <ul style="list-style-type: none"> ▪ (2) 8310-818T jamb mount actuators, (2) 8310-819S surface mount boxes ▪ Recommended for interior use only 	8310-3822T	\$526.00
Actuator package, 1-1/2" x 4-3/4", wireless, jamb mount <ul style="list-style-type: none"> ▪ (2) 8310-818T jamb mount actuators, (2) 8310-819S surface mount boxes, (2) 8310-844J jamb mount transmitters, (1) 8310-865 receiver ▪ Recommended for interior use only 	8310-3822TW	\$1,022.00
Wall mount	Specify	Price
Actuator package, 4-1/2" round, wall mount <ul style="list-style-type: none"> ▪ (2) 8310-856T wall mount actuator, (2) 8310-868S surface mount box 	8310-3860T	\$867.00
Actuator package, 4-1/2" round, wireless, wall mount <ul style="list-style-type: none"> ▪ (2) 8310-856T wall mount actuators, (2) 8310-868S surface mount boxes, (2) 8310-800 weather rings, (2) 8310-844 transmitters, (1) 8310-865 receiver 	8310-3860TW	\$1,671.00
Actuator package, 4-3/4" square, wall mount <ul style="list-style-type: none"> ▪ (2) 8310-853T wall mount actuators, (2) 8310-867S surface mount boxes 	8310-3857T	\$1,045.00
Actuator package, 4-3/4" square, wall mount <ul style="list-style-type: none"> ▪ (2) 8310-853T wall mount actuator, (2) 8310-867S surface mount box, (2) 8310-801 weather ring, (2) 8310-844 transmitter, (1) 8310-865 receiver 	8310-3857TW	\$1,851.00

8310 SERIES ACTUATORS, SENSORS AND ACCESSORIES

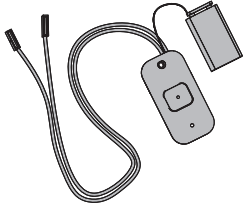
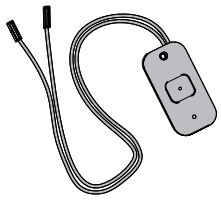
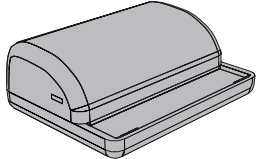
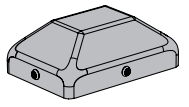
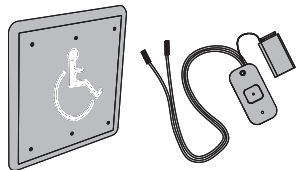
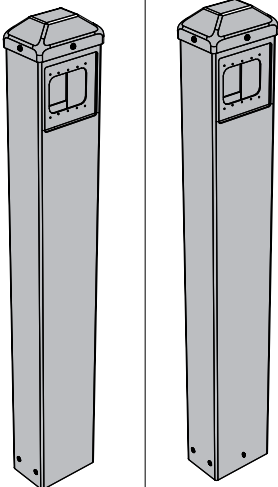
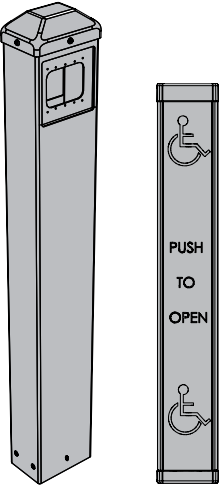
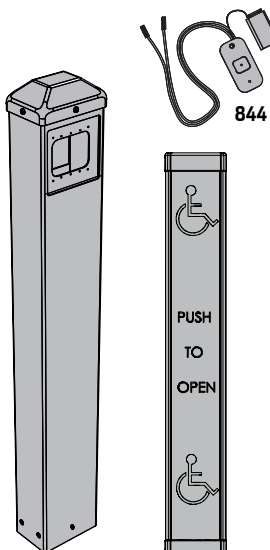
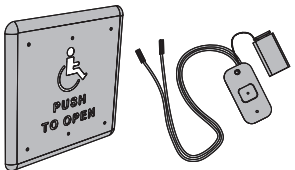
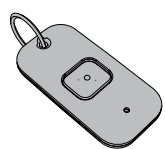
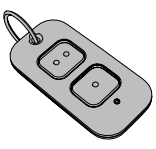
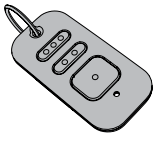
1000 SERIES
4000 SERIES
CONCEALED
FIRE/LIFE SAFETY
HIGH SECURITY
AUTO OPERATORS
ACTUATORS, ACCESSORIES
MISC.

<p>8310-844</p> 	<p>8310-844J</p> 	<p>8310-865</p> 	<p>8310-866CAP</p> 	
<p>8310-3853WB</p>  <p>853 844</p>	<p>8310-866 8310-866FLA</p> 		<p>8310-3836T</p>  <p>866FLA 836T</p>	<p>8310-3836TW</p>  <p>844</p> <p>866FLA 836TW</p>
<p>8310-3853TWB</p>  <p>853T 844</p>	<p>8310-861</p> 		<p>8310-862</p> 	<p>8310-863</p> 
<p>8310-864</p> 		<p>8310-864</p> 		

✎ Handing required

8310 SERIES ACTUATORS, SENSORS AND ACCESSORIES

Transmitters and receivers, 433 MHz		
Transmitters and receivers	Specify	Price
Transmitter, wireless, 1 channel, wall mount, 9v ▪ Used to convert standard wall mount actuator to wireless. Requires 8310-865 receiver.	8310-844	\$260.00
Transmitter, wireless, 1 channel, jamb mount, 3v ▪ Used to convert standard jamb mount actuator to wireless. Requires 8310-865 Receiver.	8310-844J	\$260.00
Transmitter, wireless, 1 channel, handheld, 9v ▪ Requires 8310-865 receiver	8310-861	\$260.00
Transmitter, wireless, 2 channel, handheld, 9v ▪ Requires at least one 8310-865 receiver	8310-862	\$260.00
Transmitter, wireless, 3 channel, handheld, 9v ▪ Requires at least one 8310-865 receiver.	8310-863	\$260.00
Transmitter, wireless, 4 channel, handheld, 9v ▪ Requires at least one 8310-865 receiver	8310-864	\$260.00
Receiver, wireless, 1 channel, sequencing feature ▪ Used in conjunction with wireless actuators and transmitters	8310-865	\$273.00

Bollard posts and kits		
Bollard posts	Specify	Price
42" x 4" x 6" bollard post, mounting base, actuator cut-out ▪ Requires actuator. Can be used with 8310-853 wall mount actuator, 8310-853T wall mount actuator or 8310-855 wall mount actuator for hardwired applications. Can be used with 8310-3853WB or 8310-3853TWB for wireless applications. Includes 8310-866CAP. Available in 689 Aluminum or 695 Dark Bronze (please specify).	8310-866.[Finish]	\$1,176.00
42" x 4" x 6" bollard post, mounting base, full length actuator only ▪ Requires 8310-836T full length actuator or 8310-836TW full length actuator. Includes 8310-866CAP. Available in 689 Aluminum or 695 Dark Bronze (please specify).	8310-866FLA.[Finish]	\$1,176.00
Plastic cap, protective cover, service part ▪ Formed plastic cap for 8310-866 bollard post	8310-866CAP	\$192.00

Wireless actuator bollard kits		
	Specify	Price
4-3/4" square with logo, wireless ▪ For use with 8310 866 bollard post. ▪ Includes 8310-853 actuator, 8310-844 transmitter kit. ▪ Requires 8310-865 receiver.	8310-3853WB	\$557.00
4-3/4" square with logo, wireless ▪ For use with 8310-866 bollard post. ▪ Includes 8310-853T actuator, 8310-844 transmitter kit. ▪ Requires 8310-865 receiver.	8310-3853TWB	\$557.00
Actuator, 36" x 6" full length, logo, text ▪ Bollard post available in 689 Aluminum or 695 Dark Bronze (please specify). ▪ Includes 8310-866FLA bollard post and 8310-836T full length actuator.	8310-3836T.[Finish]	\$2,351.00
Actuator, 36" x 6" full length, logo, text, wireless ▪ Includes 8310-844J. Requires 8310-865 bollard post available in 689 Aluminum or 695 Dark Bronze (please specify). ▪ Includes 8310-866FLA bollard post, 8310-836T full length actuator and 8310-844 wireless transmitter kit.	8310-3836TW	\$2,569.00
Receiver, wireless, 1 channel, sequencing feature ▪ Used in conjunction with wireless actuators and transmitters	8310-865	\$273.00

✎ Handing required

8310 SERIES ACTUATOR ACCESSORIES

1000 SERIES

4000 SERIES

CONCEALED

FIRE/LIFE SAFETY

HIGH SECURITY

AUTO OPERATORS

ACTUATORS, ACCESSORIES

MISC.

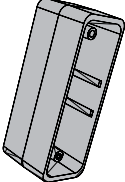
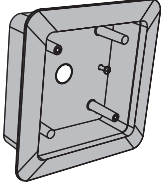
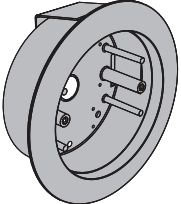
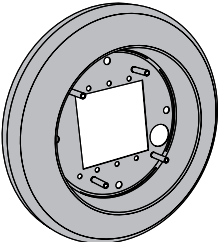
<p>8310-800</p> 	<p>8310-801</p> 	<p>8310-802</p> 	
<p>8310-819F</p> 	<p>8310-819S</p> 	<p>8310-867F</p> 	<p>8310-867S</p> 
<p>8310-868F</p> 	<p>8310-868S</p> 	<p>8310-869F</p> 	<p>8310-869S</p> 
<p>8310-874</p> 	<p>8310-876</p> 		

8310 SERIES ACTUATOR ACCESSORIES

Optional Actuator Accessories		
Weather rings	Specify	Price
Weather ring, 4-1/2" round ▪ Can be used with any 4-1/2" round actuator	8310-800	\$31.00
Weather ring, 4-1/2" square ▪ Can be used with any 4-1/2" square actuator	8310-801	\$31.00
Weather ring, 6" round ▪ Can be used with any 6" round actuator	8310-802	\$31.00
Boxes	Specify	Price
Jamb box only, 1-1/2" x 4-3/4" rectangle, flush mount ▪ Should be used on an interior installation ▪ Can be used with any 1-1/2" x 4-3/4" jamb mount actuator	8310-819F	\$50.00
Jamb box only, 1-1/2" x 4-3/4", rectangle, surface mount ▪ Should be used on an interior installation only ▪ Can be used with any 1-1/2" x 4-3/4" jamb mount actuator	8310-819S	\$50.00
Box only, 4-3/4" square, flush mount ▪ Can be used with any 4-3/4" square actuator	8310-867F	\$216.00
Box only, 4-3/4" square, surface mount ▪ Can be used with any 4-3/4" square actuator	8310-867S	\$216.00
Box only, 4-1/2" round, flush mount ▪ Can be used with any 4-1/2" round actuator	8310-868F	\$192.00
Box only, 4-1/2" round, surface mount ▪ Can be used with any 4-1/2" round actuator	8310-868S	\$192.00
Box only, 6" round, flush mount ▪ Can be used with any 6" round actuator	8310-869F	\$211.00
Box only, 6" round, surface mount ▪ Can be used with any 6" round actuator	8310-869S	\$211.00
Box only, jamb surface mount ▪ Should be used with 8310-813J & 8310-813JWH ▪ For wireless transmission, the 8310-885 should be used along with the 8310-880 receiver	8310-819SJ	\$50.00
Escutcheon	Specify	Price
Escutcheon, 4-1/2" round, decorative, protective ▪ Can be used with any 4-1/2" round actuator	8310-874	\$476.00
Escutcheon, 6" round, decorative, protective ▪ Can be used with any 6" round actuator	8310-876	\$476.00

8310 SERIES ACTIVATION/SAFETY SENSORS

8310-804-1

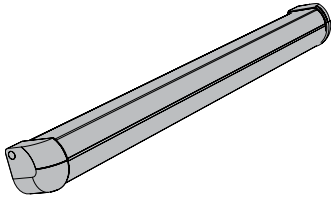

8310-804-2

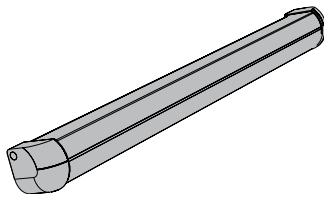

8310-854



8310-877

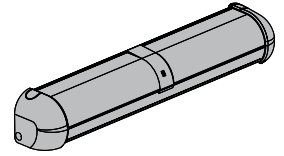

8310-878



8310-879



8310-3881



8310-3882



8310-3883

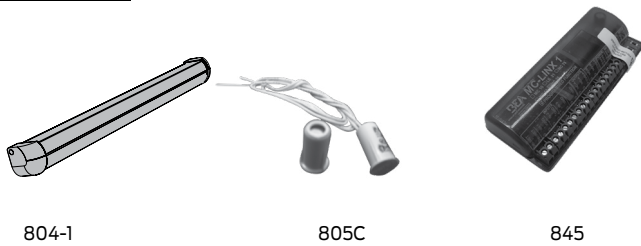

8310-3891

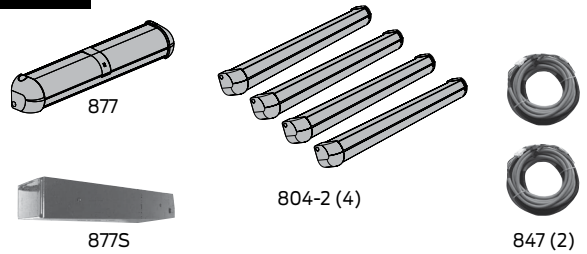

8310-3892

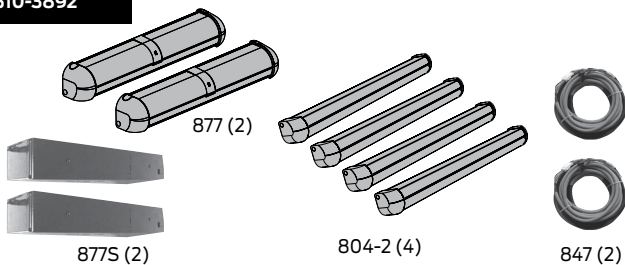

1000 SERIES

4000 SERIES

CONCEALED

FIRE/LIFE SAFETY

HIGH SECURITY

AUTO OPERATORS

ACTUATORS, ACCESSORIES

MISC.

8310 SERIES ACTIVATION/SAFETY SENSORS

Safety sensors		
Individual activation/safety sensors	Specify	Price
Door mount safety sensor, sensor with one element ▪ Used to sense obstruction(s) on leading edge of door	8310-804-1	\$1,610.00
Door mount safety sensor, sensor with two elements ▪ Used to sense obstruction(s) on full face of door	8310-804-2	\$2,197.00
Header mount activation sensor, 'K' band technology	8310-854	\$1,022.00
Header mount safety sensor, 'diffused infrared' technology ▪ Provides 'safety function' during door open and door closed position. Nine selectable/programmable patterns. ▪ Optional 8310-859 handheld remote control can be used to program 8310-877 sensor from a distance. ▪ Includes 8310-846 harness.	8310-877	\$1,949.00
Safety sensor kits	Specify	Price
Monitored safety sensor kit for single door applications ▪ Contains (2) door-mounted sensors and a control hub that perform the swing door safety functions and provides the sensor monitoring required by A156.10. ▪ All wire harnesses and mounting hardware included.	8310-878	\$5,570.00
Monitored safety sensor kit for all double door applications ▪ Contains (4) door-mounted sensors and a control hub that perform the swing door safety functions and provides the sensor monitoring required by A156.10. ▪ All wire harnesses and mounting hardware included.	8310-879	\$9,937.00
Activation and safety sensor package – Senior Swing single door ▪ (2) 8310-854 header mount activation sensors, (1) 8310-878 monitored safety sensor kit (includes (2) door mounted safety sensors and (1) control hub for monitoring)	8310-3881	\$7,613.00
Activation and safety sensor package – Senior Swing double door ▪ (2) 8310-854 header mount activation sensors, (1) and 8310-879 monitored safety sensor kit (Includes (4) door mounted safety sensors and (1) control hub for monitoring)	8310-3882	\$9,999.00
Activation/safety sensor package, low energy convenience, single door ▪ Includes 8310-804-1 door mount safety sensor, 8310-805C door position switch (concealed), 8310-845 programmable relay module.	8310-3883	\$2,197.00
Safety sensor package – Senior Swing simultaneous pair ▪ (1) 8310-877 header mount sensor, (1) 8310-877S header mount spacer, (4) 8310-804-2 door mount sensors, (2) 8310-847 harnesses ▪ Use with Senior Swing only	8310-3891	\$9,373.00
Safety sensor package – Senior Swing independent pair ▪ (2) 8310-877 header mount sensors, (2) 8310-877S header mount spacers, (4) 8310-804-2 door mount sensors, (2) 8310-847 harnesses	8310-3892	\$9,999.00

8310 SERIES ACTIVATION/SAFETY SENSOR ACCESSORIES

1000 SERIES

4000 SERIES

CONCEALED







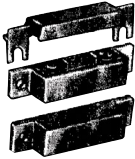

FIRE/LIFE SAFETY

HIGH SECURITY

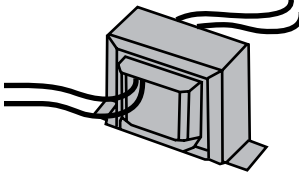
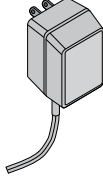
AUTO OPERATORS

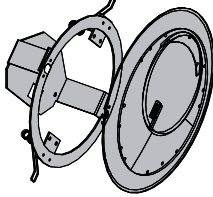
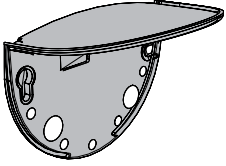
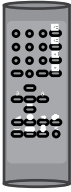
ACTUATORS, ACCESSORIES

MISC.

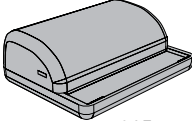
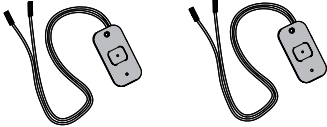
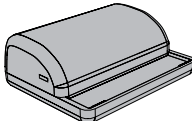
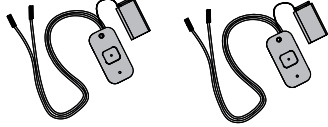
<p>8310-805</p> 	<p>8310-805C</p> 	<p>8310-824</p> 	<p>8310-824P</p> 
<p>8310-846</p> 	<p>8310-847</p> 	<p>8310-854ECA</p> 	<p>8310-854ERA</p> 
<p>8310-859</p> 	<p>8310-877S</p> 	<p>8310-3888</p> 	<p>8310-3889</p> 
<p>8310-3803</p>  <p>865</p>  <p>844J (2)</p>		<p>8310-3809</p>  <p>865</p>  <p>844 (2)</p>	

8310 SERIES ACTIVATION/SAFETY SENSOR ACCESSORIES

Accessories		
Switch, door position	Specify	Price
Door Position Switch (DPS), surface mount	8310-805	\$73.00
Door Position Switch (DPS), concealed	8310-805C	\$73.00
Transformer	Specify	Price
Transformer, 24v, hardwired	8310-824	\$105.00
Transformer, 24v, plug in	8310-824P	\$105.00
Harness, header mount	Specify	Price
Harness, header mount ▪ Used with 8310-877 header mount safety sensor	8310-846	\$37.00
Harness, door mount ▪ Used with 8310-804-1 or 8310-804-2 door mount safety sensor	8310-847	\$149.00
Other	Specify	Price
Bracket, drop ceiling ▪ Optional bracket used with 8310-854 header mount activation sensor	8310-854ECA	\$267.00
Cover, protective ▪ Optional cover used w/ 8310-854 header mount activation sensor	8310-854ERA	\$180.00
Remote control, handheld ▪ Optional handheld remote that can be used to program 8310-877 header mount safety sensor or 8310-854 header mount motion sensor	8310-859	\$229.00
Header mount safety sensor spacer ▪ For use in applications that require door mounted & header mounted safety sensors	8310-877S	\$211.00
Wireless conversion kit, jamb mount, 3v ▪ Converts standard jamb actuator to wireless version. ▪ (2) 8310-844J transmitters, (1) 8310-865 receiver ▪ Requires 8310-819s or 8310-819s	8310-3803	\$748.00
Wireless conversion kit, wall mount, 9v ▪ Converts standard wall mount actuator to wireless version. ▪ (2) 8310-844 transmitters, (1) 8310-865 receiver ▪ Requires surface or flush box and weather ring	8310-3809	\$748.00
Harness, safety module, service part ▪ Pneumatic safety module harness included in 8310-3889 safety module kit	8310-3888	\$50.00
Pneumatic safety module kit ▪ Used with 7901, 7902, 7981, 7982 control boxes ▪ Includes 8310-3888 safety module harness, 8310-845 time delay relay ▪ Required when 8310-877 header mount safety sensor is used with pneumatic automatic operators	8310-3889	\$670.00

8310 SERIES ACTUATORS, SENSORS AND ACCESSORIES

8310-806K

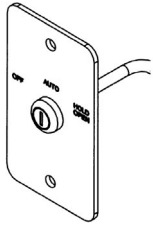

8310-806R

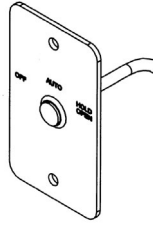

8310-807



8310-845



1000 SERIES

4000 SERIES

CONCEALED

FIRE/LIFE SAFETY

HIGH SECURITY

AUTO OPERATORS

ACTUATORS, ACCESSORIES

MISC.

8310 SERIES ACTUATORS, SENSORS AND ACCESSORIES

Accessories		
Accessories	Specify	Price
Key switch (on/off/hold-open) ▪ Optional switch used with Senior Swing, Benchmark, or 4600 Series operators with CS configuration.	8310-806K	\$273.00
Rocker switch (on/off/hold-open) ▪ Optional switch with Senior Swing, Benchmark, or 4600 series operators with CS configuration.	8310-806R	\$273.00
Line filter, AC, 120v ▪ Optional filter used with Senior Swing operators to reduce 'line noise'.	8310-807	\$273.00
Programmable relay module ▪ Used to sequence doors and program functions outside the standard controller.	8310-845	\$422.00
Low energy automatic operator labels	Specify	Price
English caution label	155-1	\$9.00
English activation label	155-2	\$9.00
French caution label	155-3	\$9.00
English label kit, Benchmark Includes: (2) Caution (1) Push to Activate (1) Pull to Activate (2) Activate Switch to Operate	3155BM	\$37.00
French label kit, Benchmark Includes (2) Caution (French) (2) Activate Switch to Operate (English) (1) Push to Operate (English) (1) Pull to Operate (English)	3155BMF	\$37.00
English label kit, Senior Swing Includes: (2) Caution (English) (2) Activate Switch to Operate (English) (1) Push to Operate (English) (1) Pull to Operate (English)	3155SS	\$37.00
French label kit, Senior Swing Includes (2) Caution (French) (2) Activate Switch to Operate (English) (1) Push to Operate (English) (1) Pull to Operate (English)	3155SSF	\$37.00

PARTS AND ACCESSORIES

Powder coat

622	Matte Black (MTBLK)
689	Aluminum (AL)
690	Statuary Bronze (STAT)
691	Light Bronze (LTBRZ)
693	Black (GLBLK)
695	Dark Bronze (DKBRZ)
696	Brass (BRASS)

Plated

616	Satin Bronze, Blackened (US11)
632	Brass (US3)
633	Satin Brass (US4)
639	Satin Bronze (US10)
646	Satin Nickel (US15)
651	Bright Chrome (US26)
652	Satin Chrome (US26D)

Anodized

628	Aluminum (ANCLR)
710	Dark Bronze (ANDKB)

Handing

RH	Right hand
LH	Left hand

Parallel arm holder	Specify		Price		
	Part number	Finish	Powder coat	652 plated	Other plated
Door Holder	PAH 60	.[Finish]	\$174.00	\$451.00	\$539.00

Force gauge	Specify		Price		
	Part number	Finish	Powder coat	652 plated	Other plated
Force Gauge	ADA/FG			\$73.00	

LCN spray paint	Specify		Price		
	Part number	Finish	Powder coat	652 plated	Other plated
Spray paint	PAINT	.[Finish]		\$37.00	
Spray paint, 6 cans same color	PAINT-CS	.[Finish]		\$161.00	

Fasteners Individual and sets	Specify		Price		
	Part number	Finish	Powder coat	652 plated	Other plated
SRT Screw (1 ea.)	SRT	.[Finish]	\$5.00	\$5.00	\$5.00
SRT Screw (4 ea.)	SRT/4	.[Finish]	\$7.00	\$7.00	\$7.00
Machine Screw (1 ea.)	MS	.[Finish]	\$5.00	\$7.00	\$9.00
Machine Screw (4 ea.)	MS/4	.[Finish]	\$7.00	\$14.00	\$19.00
Wood Screw (1 ea.)	WS	.[Finish]	\$5.00	\$7.00	\$9.00
Wood Screw (4 ea.)	WS/4	.[Finish]	\$7.00	\$14.00	\$17.00
TORX Screw (1 ea.)	TORX	.[Finish]	\$6.00	\$13.00	\$16.00
TORX Screw (4 ea.)	TORX/4	.[Finish]	\$8.00	\$18.00	\$24.00
Thru Bolt, Female	TB 1.75"	.[Finish]	\$6.00	\$11.00	\$14.00
Thru Bolt, Female	TB 1.37"	.[Finish]	\$6.00	\$11.00	\$14.00
Thru Bolt, Female	TB 1.62"	.[Finish]	\$6.00	\$11.00	\$14.00
Thru Bolt, Female (4 ea.)	TB(SET4)	.[Finish]	\$9.00	\$26.00	\$31.00
TB(1) and MS(1)	TB/MS1EA	.[Finish]	\$7.00	\$11.00	\$14.00
TB(4) and MS(4)	TB/MS4EA	.[Finish]	\$10.00	\$30.00	\$37.00

Torx (security) driver bits	Specify		Price		
	Part number	Finish	Powder coat	652 plated	Other plated
T-10 TORX Bit	T-10			\$18.00	
T-15 TORX Bit	T-15			\$18.00	
T-20 TORX Bit	T-20			\$18.00	
T-25 TORX Bit	T-25			\$18.00	
T-27 TORX Bit	T-27			\$18.00	

Adjustment wrenches	Specify		Price		
	Part number	Finish	Powder coat	652 plated	Other plated
Hold Open Wrench	T1157			\$9.00	

Green hex wrenches	Specify	Price
Green Hex Wrench (1 ea.)	GHW1	\$13.00
Green Hex Wrench (12 ea.)	GHW12	\$98.00
Green Hex Wrench (100 ea.)	GHW100	\$743.00

Backup power supplies	Specify	Price
SOLA Unit	SOLA	\$1,620.00
Cabinet	SOLAC	\$270.00
SOLA unit and cabinet	SOLAK	\$1,782.00

Finish samples	Specify			Price		
	Part number	Finish		Powder coat	652 plated	Other plated
Powder coat finish sample	4040SE-59A	.[Finish]		\$9.00	-	-
Plated finish sample	2210-12	.[Finish]		-	\$93.00	\$130.00
	Part number	Finish		RAL	-	-
RAL finish sample	2210-12	.[Finish]		\$37.00	-	-
Finish sample for anodized finishes	Part number	Finish	Length	Anodized	-	-
	9540-511	.[Finish]	.[Length]	\$26.00/ft	-	-



1000 SERIES

4000 SERIES

CONCEALED

FIRE/LIFE SAFETY

HIGH SECURITY

AUTO OPERATORS

ACTUATORS, ACCESSORIES

MISC.



Allegion's collaboration platform for the life-cycle of the opening

Capture, maintain, and collaborate on door hardware requirements for BIM and non-BIM projects.

Track and review changes to openings and hardware selections.

Select an opening and view the plans, hardware sets, and product information.

© 2021 Allegion 013845

Making doors the easiest part of the building

Allegion's Overtur™ is the digital environment connecting all building phases in opening design, construction and ongoing management.

Learn more at discover-overtur.allegion.com or contact your Regional Sales Office.

KRYPTONITE ■ LCN ■  ■ STEELCRAFT ■ VON DUPRIN



1000 SERIES

4000 SERIES

CONCEALED

FIRE/LIFE SAFETY

HIGH SECURITY

AUTO OPERATORS

ACTUATORS, ACCESSORIES

MISC.

About Allegion

Allegion (NYSE: ALLE) is a global pioneer in seamless access. We keep people and their assets safe, wherever they are, bringing together simple solutions, convenient access and advanced technology.

For more, visit www.allegion.com

KRYPTONITE ■ LCN ■  ■ STEELCRAFT ■ VON DUPRIN