

Architectural Door Accessories

ASSA ABLOY
Opening Solutions

The global leader in
door opening solutions

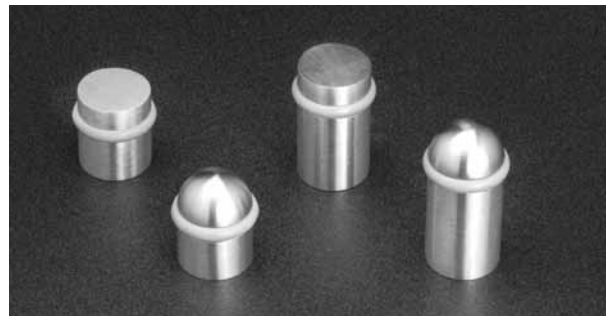
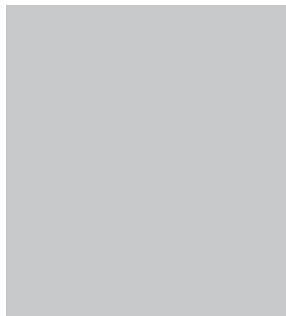
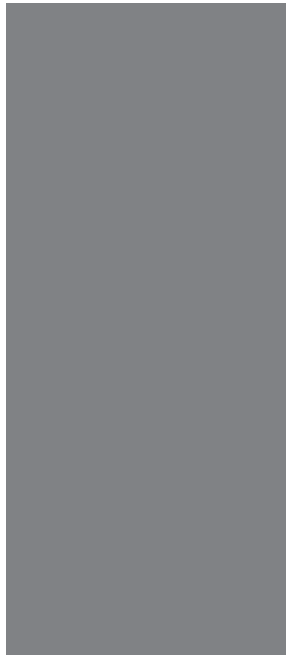
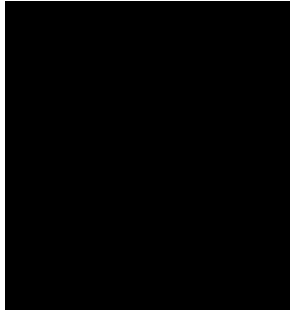

Rockwood Products Price Book - Architectural Series

USA & Canada Prices Effective June 3, 2019

Table of Contents

General Information	2-5		
Numeric Index	3		
Ordering Information	4		
Post Mounted Pulls/General Information	5		
Architectural Pulls	6-55		
AccenTek™ (solid pulls with accents)	39		
AccenTek™ Solid Groove Pulls	39		
ArborMet (wood grip pulls)	31-33		
ArborTek (wood grip pulls)	34-37		
BandWidth (collar mount pulls)	14		
Centrex (shaped pulls)	38		
Classic (finial pulls)	41		
Edge Pulls (for closet doors)	8		
Flush Pulls	7		
GeoMetek (hex, diamond & narrow profile pulls)	51-52		
Groove (straight & offset pulls)	17		
LineaMax (grooved pulls)	23-26		
Locking Door Pull System	53-55		
MariTek (tapered pulls)	41		
MegaCurve (long curved pulls)	12		
MegaTek (straight & offset pulls)	18-20		
MezzoTek (necked post pulls)	13		
NeoCylinder (w/ or w/o GripZone)	50		
NeoMax (pulls w/GripZone)	21-23		
NeoMetrix (w/GripZone)	17		
NeoMitre (w/ or w/o GripZone)	50		
NoirMet (black anodized grip)	27-28		
NoirTek (black anodized grip)	29-30		
OvalTek (true oval grip)	15		
		OvalTek (flat oval grip)	15
		PlanTek (flat front pulls)	40
		RightAngles (w/ or w/o GripZone)	7
		SkewTek (angled end pulls)	37
		SoftMet (*Santoprene™ grip)	16
		SoftTek (Santoprene™ grip)	16
		Traditional (decorative pulls & plates)	41
		Tubular (1 ¼" and 1 ½" diameter pulls)	6
		Leather Architectural Pulls	42-49
		English Bridle Leather (straight & offset pulls)	42-43
		Flush Leather Pulls	46-48
		Leather Oval (ergonomic pulls)	46
		Upholstery Leather GeoMetek	48
		Upholstery Leather (straight & offset pulls)	44-45
		Small Architectural Pulls	7-49
		ArborMet	12
		GripZone	11
		Groove	11
		Leather	49
		MegaTek	10
		NoirMet	12
		Wire	7
		Architectural Accessories	8-9
		Coat Hooks	8
		Door Stops	9
		Push Plates, Pull Plates and Signage	9
		Architectural Finishes	56
		Mounting Types	57
		Mounting Details	58-59
		Fasteners - Spare Parts	60-62
		Mounting Kits	63
		Discontinued Products	64-65

*Santoprene™ is a registered trademark of the Exxon Mobil Corporation.

Numeric Index

No.	Description	Page
570	Dust Proof Strike.....	55
DP3301	MegaTek Dummy Pull (round).....	55
DP3401	NeoTek Dummy Pull.....	55
DP7901	GeoMetek Dummy Pull (square)....	55
LP3301	Locking Pull PostMount.....	53
LP3401	Locking Pull NeoTek.....	53
LP6061	Locking Pull English Bridle Leather Wrapped	54
LP6161	Locking Pull Upholstery..... Leather Wrapped	54
LP6440	Locking Pull Upholstery..... Leather Wrapped	55
LP7901	Locking Pull GeoMetek.....	55
LPS01 - LPS06	Locking Pull Strikes.....	55
RM201 - RM372	Tubular.....	6
RM405 - RM423	RightAngles.....	7
RM710 - RM735	Small Pulls (Wire).....	7
RM751 - RM760	Edge Pulls - for Closet Doors.....	8
RM780 - RM790	Flush Pulls.....	7
RM801 - RM843	Coat Hooks.....	8
RM850 - RM877	Door Stops.....	9
RM1010 - RM1160	Push Plates, Pull Plates, and Signage	9
RM1200 - RM1270	Small Pulls (MegaTek, Groove)..	10-11
RM1300 - RM1370	Small Pulls (GripZone).....	11
RM1410 - RM1470	Small Pulls (NoirMet).....	12
RM1510 - RM1570	Small Pulls (ArborMet).....	12
RM2000 - RM2034	MegaCurve.....	12
RM2110 - RM2150	MezzoTek.....	13
RM2200 - RM2244	BandWidth.....	14
RM2300 - RM2330	OvalTek (true oval).....	15
RM2400 - RM2420	OvalTek (flat oval).....	15
RM2510 - RM2544	SoftMet.....	16

No.	Description	Page
RM2610 - RM2640	SoftTek.....	16
RM3010 - RM3060	NeoMetrix.....	17
RM3100 - RM3154	See RM3300-RM3342	
RM3101 - RM3131	Groove.....	17
RM3300 - RM3342	MegaTek.....	18-20
RM3400 - RM3442	NeoMax.....	21-23
RM3512 - RM3782	LineaMax.....	24-26
RM3800 - RM3854	NoirMet.....	27-28
RM3900 - RM3954	NoirTek.....	29-30
RM4000 - RM4054	ArborMet.....	31-33
RM4100 - RM4190	ArborTek.....	34-37
RM4200 - RM4274	SkewTek.....	37
RM4400 - RM4516RH	Centrex.....	38
RM4700 - RM4820	AccenTek™.....	39
RM5200 - RM5280	PlanTek.....	40
RM5500 - RM5598	Traditional.....	41
RM5650 - RM5670	Classic.....	41
RM5700 - RM5702	MariTek.....	41
RM6060 - RM6092	English Bridle Leather.....	42-43
RM6160 - RM6192	Upholstery Leather.....	44-45
RM6200 - RM6240	Leather Oval.....	46
RM6300 - RM6354	Flush Leather Pulls.....	46-48
RM6400 - RM6440	Upholstery Leather GeoMetek.....	48
RM6500 - RM6730	Small Pulls (Leather).....	49
RM7210 - RM7240	NeoCylinder.....	50
RM7300 - RM7450	NeoMitre.....	50
RM7700 - RM7815	GeoMetek (Hexagonal).....	51
RM7800 - RM7815	GeoMetek (Diamond).....	51
RM7900 - RM7960	GeoMetek (Narrow Profile).....	51-52
SP1001 - SP1082	Fasteners - Spare Parts.....	60-62
KIT1 - KITRM380G	Mounting Kits.....	63

Ordering Information

This price list cancels and supersedes all prior listings.

Orders are accepted with the understanding that they will be billed at prices in effect at time of shipment.

Prices are subject to change without notice.

We reserve the right to decline the whole or part of orders in which the price or quantity of goods is not acceptable to us.

NOTE: If matching pulls to a previous job, please provide original PO or Order #.

Easy Order Placement

USA:

By Phone: 1-800-458-2424 Monday through Thursday 8:00 am ET to 7:00 pm ET, Friday 8:00 am ET to 4:30 pm ET

By Fax: Orders may be faxed to 1-800-922-9212

By Email: orders.rockwood@assaabloy.com

By Internet: <http://extranet.assaabloydss.com/> and select Order Entry under the Customer Service Menu

Canada:

By Phone: 1-800-461-3007 Monday through Friday 8:00 am ET to 4:30 pm ET

By Fax: Orders may be faxed to 1-800-461-8989

By Email: cavau-orders@assaabloy.com

By Internet: <http://extranet.assaabloydss.ca/> and select Order Entry under the Customer Service Menu

Terms and Conditions of Sale

Terms: 1% 15 days, net 30 days

Remit Payment To: PNC Bank/Rockwood, PO Box 644489, Pittsburgh, PA 15264-4489

For Terms & Conditions and Warranty information pertaining to product sales in Canada, please visit www.assaabloy.ca/terms

Freight Policy

Freight Allowance: All prices are F.O.B. Rockwood, Pennsylvania and/or Ventura, California. Full freight will be allowed on shipments of \$1,000 net and over within the continental limits of the United States (excluding Alaska and Hawaii). All shipments are routed most cost effective route of our choice. We reserve the right to designate the carrier.

Special Order Material

Special items made to your specifications are not returnable. These items are not subject to cancellation without consideration of expense involved at the cancellation date.

Samples

Salable samples will be charged at regular prices.

Returned Goods

Return no merchandise without written permission from the factory. Authorization will insure your receiving proper credit. Errors in shipping may occasionally occur. If this is the case immediately notify the factory, and we will gladly make the proper adjustments. If the error is at the customer's end, a minimum charge of 25% plus freight will be incurred for handling. Unauthorized claims for labor or charges will not be allowed. No credit will be allowed beyond six months after invoice date.

Shortages

Claims for shortages must be made within 30 days of invoice date.

Templates

Upon request we will furnish templates for any of our standard items of manufacture. Commonly used templates are available on our website at www.assaabloydooraccessories.us.

Product Weight Information

NOTE: Weights indicated throughout the price list are approximate for brass, bronze or stainless steel base material. Aluminum base materials weigh approximately $\frac{1}{3}$ the listed weights.

Engraving

Engraving may be added on many pulls and plates. Call factory for pricing.

For Terms and Conditions as well as Warranty information pertaining to product sales in Canada, please visit www.assaabloy.ca/terms

ASSA ABLOY

Opening Solutions





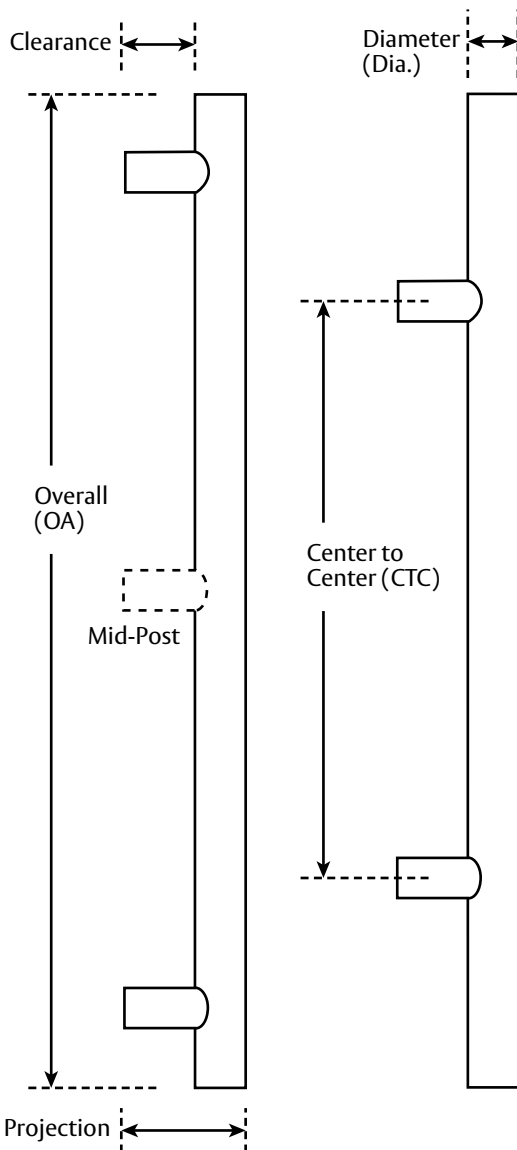

The global leader in
door opening solutions

Post Mounted Pulls

It is our goal that you get the best possible functional and aesthetic door pull from our wide selection. On long door pulls there will naturally be a small amount of flexing between mounting points that are far apart. We offer the following guidelines to help you determine when a mid-post is required or when you should consider altering the location of the mounting posts (by moving them closer together) in order to minimize the flexing of the grip. Making the grip rigid by adding a mid-post is the ideal condition for long pulls on all doors but is particularly important on all glass doors that have an inherent flexing in the door itself. The combined flexing of the door and the pull can loosen mechanical joints and stress the fasteners.

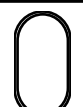
Our recommendations for adding a mid-post to long door pulls is based on a theoretical pull load of 30 lbs. (foot pounds) maximum to open the door, which is a greater than the typical force required to open an average door. The maximum amount of deflection of the grip you will see at that force is $\frac{3}{8}$ ". The conditions on your job site can vary due to door weight, wind loading, closer settings, locked doors being aggressively pulled and other circumstances. It is our recommendation that you add a mid-post if there is any question about heavy or hard to open doors; having an extra mounting point always makes for a more stable and durable installation.

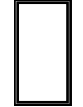

POST MOUNTED PULLS SHAPES AND SIZES			
SHAPE	MATERIAL	MATERIAL Size	MAXIMUM CTC
Round			
	Stainless Steel	1"	70"
		1 1/4"	90"
		1 1/2"	110"
	Brass/Bronze	1"	57"
		1 1/4"	73"
		1 1/2"	87"
Aluminum	1"	66"*	
	1 1/4"	90"*	
	1 1/2"	115"*	
Oval			
	Stainless Steel	1" x 1 1/2"	100"
		1" x 1 7/8"	119"
Flat Oval			
	Stainless Steel	3/4" x 1 1/2"	93"
Square			
	Stainless Steel	3/4" x 3/4"	62"
		1" x 1"	85"
Rectangular			
	Stainless Steel	1/2" x 1 1/4"	86"
		3/4" x 1 1/2"	110"
	Brass/Bronze	3/4" x 1 1/2"	89"
Rectangular			
	Stainless Steel	1/2" x 1 1/4"	52"
		3/4" x 1 1/2"	75"
	Brass/Bronze	3/4" x 1 1/2"	60"

*The maximum length of anodized aluminum pulls is 87" due to our tank size. Longer aluminum pulls are available in satin finish and clear coated or powder coat paint.

On long pulls, post can be positioned closer to each other and farther away from ends as a strategy to avoid mid-post if door condition permits.

Tubular - 1 1/4" & 1 1/2" Diameter Pulls

Straight Pulls											
Part	CTC	Dia.	28/628	313/710 315/711	3/605 4/606	10/612 10B/613	Stock PC 10BE	32D/630	32/629	32D316	32316
RM301	12"	1 1/4"	138	152	349	377	196	135	152	187	209
RM302	18"	1 1/4"	154	171	371	400	217	156	175	215	240
RM303	24"	1 1/4"	171	188	391	422	238	176	197	243	272
RM304	36"	1 1/4"	204	225	433	469	313	216	242	298	333
RM321	12"	1 1/2"	154	170	424	458	231	169	189	233	260
RM322	18"	1 1/2"	171	188	445	481	252	189	212	261	291
RM323	24"	1 1/2"	187	206	466	504	272	209	234	288	322
RM324	36"	1 1/2"	220	243	508	548	348	249	279	344	385

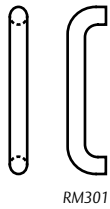

RM301

90° Offset Pulls											
Part	CTC	Dia.	28/628	313/710 315/711	3/605 4/606	10/612 10B/613	Stock PC 10BE	32D/630	32/629	32D316	32316
RM201	12"	1 1/4"	157	179	266	280	226	165	202	217	253
RM202	18"	1 1/4"	172	196	296	310	246	184	221	239	275
RM203	24"	1 1/4"	185	211	325	341	265	202	238	267	304
RM204	36"	1 1/4"	217	241	391	407	323	226	265	295	333
RM221	12"	1 1/2"	203	223	318	341	252	189	238	260	290
RM222	18"	1 1/2"	217	233	354	371	311	214	265	295	330
RM223	24"	1 1/2"	233	248	399	413	335	237	291	328	365
RM224	36"	1 1/2"	264	279	471	487	366	268	321	369	411

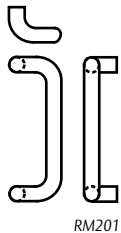

RM201

Push Bars - Add \$6/in. per bar for extra length bars over 36".											
Part	CTC	Dia.	28/628	313/710 315/711	3/605 4/606	10/612 10B/613	Stock PC 10BE	32D/630	32/629	32D316	32316
RM350	Up to 36"	1 1/4"	203	227	296	318	252	189	212	261	267
RM370	Up to 36"	1 1/2"	233	256	354	383	329	231	259	319	356

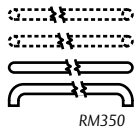

RM350

Straight Push Pull Sets - Specify Push Bar CTC. Add \$6/in. per bar for extra length bars over 36".											
Part	CTC	Dia.	28/628	313/710 315/711	3/605 4/606	10/612 10B/613	Stock PC 10BE	32D/630	32/629	32D316	32316
RM351	12"	1 1/4"	321	361	520	560	445	343	386	474	487
RM352	18"	1 1/4"	330	367	550	593	458	356	398	491	500
RM371	12"	1 1/2"	398	437	624	674	508	404	452	556	622
RM372	18"	1 1/2"	421	459	644	695	557	428	480	592	660

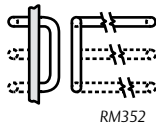

RM352

Offset Push Pull Sets - Specify Push Bar CTC. Add \$6/in. per bar for extra length bars over 36".											
Part	CTC	Dia.	28/628	313/710 315/711	3/605 4/606	10/612 10B/613	Stock PC 10BE	32D/630	32/629	32D316	32316
RM251	12"	1 1/4"	377	421	578	624	473	370	414	509	537
RM252	18"	1 1/4"	390	437	608	656	489	386	432	532	556
RM271	12"	1 1/2"	451	490	689	744	563	435	487	599	668
RM272	18"	1 1/2"	470	506	725	784	588	460	513	632	705

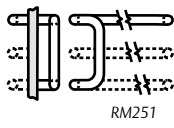

RM251

Heavy Duty 30° Offset Pulls											
Part	CTC	Dia.	28/628	313/710 315/711	3/605 4/606	10/612 10B/613	Stock PC 10BE	32D/630	32/629	32D316	32316
RM257	10"	1 1/4"	165	179	358	387	336	238	267	328	361
RM258	12"	1 1/4"	179	196	383	414	358	260	292	358	383
RM259	18"	1 1/4"	185	203	423	457	386	287	320	395	414

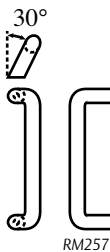

RM257

NOTE: Engraving "Push" or "Pull" add \$103.00 (1/2" letter height).

NOTE: Post location on push bars can be located 1/8" from end for narrow & medium stile doors and 1" from end for flush and wide stile doors.

RightAngles - with or without GripZone

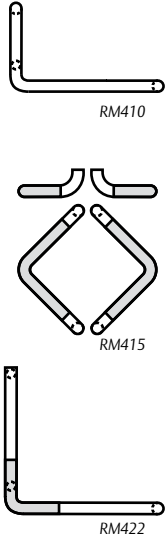

Without GripZone (RM410-RM413 specify handing and height x width when ordering.)									
Part	28/628	313/710 315/711	3/605 4/606	10/612 10B/613	Stock PC 10BE	32D/630	32/629	32D316	32316
RM405-15	249	282	403	436	350	213	240	292	331
RM410 (leg up)	514	591	862	931	650	440	506	604	695
RM411 (leg down)	514	591	862	931	650	440	506	604	695
RM412 (leg up)	873	998	974	1,053	1,012	746	854	1,026	1,174
RM413 (leg down)	873	998	974	1,053	1,012	746	854	1,026	1,174
With GripZone (RM420-RM423 specify handing and height x width when ordering.)									
Part	3/605	9/611	32/629	32316					
RM415-15	554	640	409	744					
RM420 (leg up)	1,090	1,249	800	1,451					
RM421 (leg down)	1,090	1,249	800	1,451					
RM422 (leg up)	1,408	1,619	1,022	1,883					
RM423 (leg down)	1,408	1,619	1,022	1,883					

Small Pulls - for Cabinets, Casework and Closets

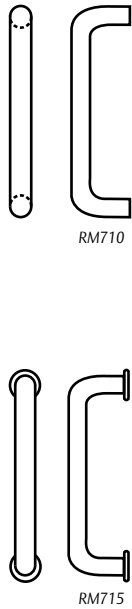

Wire Pulls - without base plates								
Part	CTC	Dia.	3/605 4/606	10B/613	Stock PC 10BE	26/625 26D/626	32D/630	32/629
RM710-4	4"	3/8"	35	38	37	35	22	24
RM710-5	5"	3/8"	36	39	38	36	23	25
RM710-6	6"	3/8"	38	41	40	39	24	28
RM720-4	4"	1/2"	42	46	42	42	24	28
RM720-5	5"	1/2"	43	47	44	43	25	30
RM720-6	6"	1/2"	45	48	46	45	28	32
RM730-5	5"	5/8"	49	53	48	49	30	33
RM730-6	6"	5/8"	51	54	49	51	31	34
RM730-7	7"	5/8"	52	57	50	52	32	35
Wire Pulls - with base plates								
RM715-4	4"	3/8"	54	58	58	54	41	45
RM715-5	5"	3/8"	57	61	60	57	43	47
RM715-6	6"	3/8"	58	62	61	60	44	51
RM725-4	4"	1/2"	65	69	64	65	45	52
RM725-5	5"	1/2"	66	70	65	66	46	53
RM725-6	6"	1/2"	67	73	66	67	47	54
RM735-5	5"	5/8"	70	76	66	70	47	54
RM735-6	6"	5/8"	73	78	69	73	50	56
RM735-7	7"	5/8"	74	80	70	74	51	57

Flush Pulls

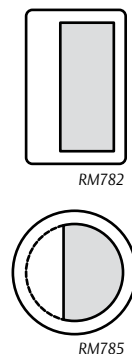

Flush Pulls					
Part	Size	3/605 4/606	10B/613	Stock PC 10BE	26/625 26D/626
RM780	2 3/16" x 3 1/4"	37	40	41	40
RM782	2 11/16" x 4 3/16"	40	42	43	42
RM785	3 1/2" Dia.	50	54	54	53



Flush Cup Pull				
Part	CTC	Stock PC 10BE	32D/630	32/629
RM790	12"	160	110	123
	24"	190	130	146
	36"	205	155	174

Edge Pulls - for Closet Doors

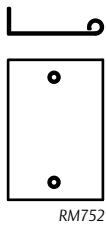

Square Edge Door						
Part	Max OA	3/605 4/606	10/612 10B/613	Stock PC 10BE	32D/630	32/629
RM751	Up to 12"	92	99	91	73	80
RM752	Up to 12"	95	102	93	75	83
Bevel Edge Door						
Part	Max OA	3/605 4/606	10/612 10B/613	Stock PC 10BE	32D/630	32/629
RM753	Up to 12"	97	105	96	77	87
RM754	Up to 12"	99	107	99	80	91



Double Edge Pull - Square Edge						
Part	Max OA	3/605 4/606	10/612 10B/613	Stock PC 10BE	32D/630	32/629
RM755	Up to 12"	181	196	164	144	162
Concealed Edge Pull						
Part	Max OA	Size	3/605 4/606	10/612 10B/613	Stock PC 10BE	26/625 26D/626
RM760	Up to 12"	1"x4 1/4"	49	53	52	53

- Specifying Information: 1. Select style pull number; 2. Select standard length [2", 2 1/2", 3", 4", 5", 6", 12" (max)]; 3. Specify door thickness [Example: RM752-4" 32D 1 3/4" door]

Coat Hooks

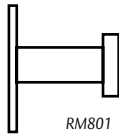

Part	Size	3/605 4/606	10B/613	Stock PC 10BE	26/625 26D/626	32D/630
RM801	1 1/4" x 1 3/4"	64	68	67	67	50
RM802	1 1/4" x 2 3/4"	65	69	68	68	53
RM803	1" x 2"	64	68	67		64
RM804	1" x 3"	65	69	68		65
RM805	1" x 1 3/4"	79	87	85	87	
RM806	1" x 3"	87	95	92	95	
RM807	1 1/4" x 2 3/4"	97	105	103	105	
RM808	1 1/4" x 3 1/2"	105	113	111	111	
RM811	3/4" x 1 1/2"	43	46	45	43	
RM812	1 1/4" x 2 1/4"	45	49	48	45	

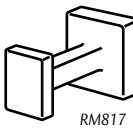

Part	Size	Stock PC 10BE	15/619
RM817	Square 1 3/4", 2 1/4" Projection	50	49

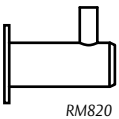

Part	Size	3/605 4/606	10B/613	Stock PC 10BE	26/625 26D/626	32D/630
RM820	1/2" x 1 5/8"			51		38
RM821	5/8" x 2 1/8"			52		39
RM822	1/2" x 1 1/2"			37		26
RM823	5/8" x 2"			39		27

Part	Size	3/605 4/606 10B/613	Stock PC 10BE	26/625 26D/626	32D/630	32/629
RM828	3/4"W x 2 7/8"	75	61		50	69
RM829	3/4"W x 1 7/8"	68	59		63	52

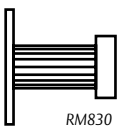

LineaMet Coat Hooks				
Part	Size	Stock PC 10BE	32D/630	32/629
RM830 (w/base plate)	1 1/4" x 2 1/4"	79	59	63
RM831	5/8" x 2 1/8"	79	59	63

ArborMet Coat Hooks				
Part	Size	Stock PC 10BE	32D/630	32/629
RM835 (w/base plate)	1 1/4" x 2 1/4"	79	59	63
RM836	5/8" x 2 1/8"	79	59	63



SoftMet Coat Hooks				
Part	Size	Stock PC 10BE	32D/630	32/629
RM838 (w/base plate)	1 1/4" x 2 1/4"	79	59	63
RM839	5/8" x 2 1/8"	79	59	63

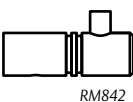

Groove Coat Hooks				
Part	Size	Stock PC 10BE	32D/630	32/629
RM840 (w/base plate)	1/2" x 1 5/8"	65	46	
RM841 (w/base plate)	5/8" x 2 1/8"	68	49	
RM842	1/2" x 1 1/2"	57	38	
RM843	5/8" x 2"	59	40	

Door Stops

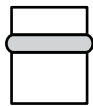

RM850

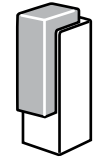

RM857



RM867

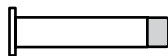

RM876

Floor Mounted						
Part	Height	3/605 4/606	10/612 10B/613	Stock PC 10BE	26/625 26D/626	32D/630
RM850	1 1/2"	42	46	45	39	37
RM851	2 1/2"	54	59	58	54	48
RM855	1 3/4"	47	51	49	43	42
RM856	2 3/4"	58	62	61	58	51
Part	Size			Stock PC 10BE	15/619	
RM857	Square 1" Base, 2 3/4" Projection			61	60	
Wall Mounted						
Part	Projection	3/605 4/606	10/612 10B/613	Stock PC 10BE	26/625 26D/626	32D/630
RM860	1 3/2"	27	29	29	26	22
RM861	1 3/2"	27	29	29	26	22
Part	Size			Stock PC 10BE	15/619	
RM867	Square 1 3/4" Base, 3/4" Projection			48	47	
Base Board Mounted						
Part	Projection	3/605 4/606	10/612 10B/613	Stock PC 10BE	26/625 26D/626	32D/630
RM870	1 1/2"	38	41	40	35	25
RM871	3 1/4"	38	41	40	35	25
RM872	3 3/4"	38	41	40	35	25
RM875	1 1/2"	53	57	55	53	39
RM876	3 1/4"	53	57	55	53	39
RM877	3 3/4"	53	57	55	53	39

Push Plates, Pull Plates and Signage



RM1010

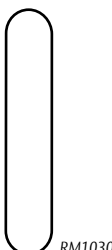

RM1030



RM1120H



RM1120L

Square Corner - Adhesive Mount						
Part	Size	3/605 4/606	10/612 10B/613	Stock PC 10BE	32D/630	32/629
RM1010	4" x 22"				56	62
RM1010H	4" x 22"				83	93
RM1010L	4" x 22"				83	93
Square Corner - Screw Mount						
RM1020	4" x 22"	85	93	65	40	46
RM1020H	4" x 22"	119	130	96	70	79
RM1020L	4" x 22"	119	130	96	70	79
Radius End Corner - Adhesive Mount						
RM1030	4" x 22"				70	79
RM1030H	4" x 22"				98	110
RM1030L	4" x 22"				98	110
Radius End Corner - Screw Mount						
RM1040	4" x 22"	103	113	80	56	62
RM1040H	4" x 22"	136	148	109	83	93
RM1040L	4" x 22"	136	148	109	83	93
Indicator Plates - Adhesive Mount						
Part	Size	3/605 4/606	10/612 10B/613	Stock PC 10BE	32D/630	32/629
RM1110H	1" Dia.	70	80	78	59	65
RM1110L	1" Dia.	70	80	78	59	65
RM1120H	2 1/2" Dia.	70	80	78	59	65
RM1120L	2 1/2" Dia.	70	80	78	59	65
RM1150M	2" x 4"	75	87	83	65	74
RM1150W	2" x 5 3/4"	78	90	85	68	76
Indicator Plates - Screw Mount						
RM1160M	2" x 4"	75	87	83	65	74
RM1160W	2" x 5 3/4"	78	90	85	68	76

MegaTek - Small Pulls for Cabinets, Casework & Closet Doors

Straight - Flat Ends								
Part	Max OA	Dia.	3/605 4/606	10/612	10B/613	Stock PC 10BE	32D/630	32/629
RM1200-4	5 7/8"	1/2"	57		61	48	24	28
RM1200-5	6 7/8"	1/2"	58		64	49	25	29
RM1200-6	7 7/8"	1/2"	59		65	61	36	42
RM1200-8	9 7/8"	1/2"	62		67	65	41	45
RM1200-10	11 7/8"	1/2"	66		70	69	44	48
RM1200-12	13 7/8"	1/2"	74		81	72	47	54
RM1200-18	19 7/8"	1/2"	99		107	76	51	58
RM1200-24	25 7/8"	1/2"	113		123	87	62	70
RM1200-30	31 7/8"	1/2"	134		144	98	72	80
RM1210-5	6 7/8"	5/8"	75		80	60	35	40
RM1210-6	7 7/8"	5/8"	76		81	64	39	44
RM1210-7	8 7/8"	5/8"	76		82	70	45	51
RM1210-8	9 7/8"	5/8"	78		84	72	47	54
RM1210-10	11 7/8"	5/8"	89		97	74	48	56
RM1210-12	13 7/8"	5/8"	95		102	76	51	58
RM1210-18	19 7/8"	5/8"	131		141	91	67	75
RM1210-24	25 7/8"	5/8"	149		161	102	76	86
RM1210-30	31 7/8"	5/8"	178		194	109	83	92
Offset - Flat Ends								
RM1230-5	6 7/8"	5/8"				101	75	84
RM1230-6	7 7/8"	5/8"				102	76	85
RM1230-7	8 7/8"	5/8"				104	79	87
RM1230-8	9 7/8"	5/8"				108	82	92
RM1230-10	11 7/8"	5/8"				109	83	93
RM1230-12	13 7/8"	5/8"				111	85	95
RM1230-18	19 7/8"	5/8"				134	96	108
RM1230-24	25 7/8"	5/8"				148	109	121
RM1230-30	31 7/8"	5/8"				152	113	127
Straight - Round Ends								
RM1240-4	5 7/8"	1/2"	67	73	73	67	43	48
RM1240-5	6 7/8"	1/2"	68	74	74	69	44	50
RM1240-6	7 7/8"	1/2"	69	75	75	70	45	51
RM1240-8	9 7/8"	1/2"	72	78	78	74	48	54
RM1240-10	11 7/8"	1/2"	74	81	81	78	53	60
RM1240-12	13 7/8"	1/2"	80	85	85	83	58	64
RM1240-18	19 7/8"	1/2"	103	113	113	99	62	69
RM1240-24	25 7/8"	1/2"	122	131	131	105	69	77
RM1240-30	31 7/8"	1/2"	136	148	148	117	80	88
RM1250-5	6 7/8"	5/8"	80		85	78	53	60
RM1250-6	7 7/8"	5/8"	82		89	79	54	61
RM1250-7	8 7/8"	5/8"	84		92	80	56	62
RM1250-8	9 7/8"	5/8"	87		94	82	57	63
RM1250-10	11 7/8"	5/8"	97		103	84	59	65
RM1250-12	13 7/8"	5/8"	101		110	86	61	68
RM1250-18	19 7/8"	5/8"	134		146	98	72	81
RM1250-24	25 7/8"	5/8"	155		166	109	83	94
RM1250-30	31 7/8"	5/8"	181		195	114	88	98
Offset - Round Ends								
RM1270-5	6 7/8"	5/8"				111	86	95
RM1270-6	7 7/8"	5/8"				112	86	96
RM1270-7	8 7/8"	5/8"				113	87	97
RM1270-8	9 7/8"	5/8"				116	89	99
RM1270-10	11 7/8"	5/8"				117	91	101
RM1270-12	13 7/8"	5/8"				120	93	104
RM1270-18	19 7/8"	5/8"				134	107	119
RM1270-24	25 7/8"	5/8"				143	116	129
RM1270-30	31 7/8"	5/8"				148	120	134

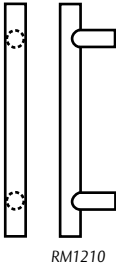

RM1210

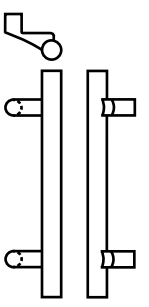

RM1230

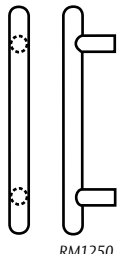

RM1250

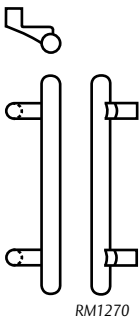

RM1270

ASSA ABLOY

Opening Solutions

The global leader in door opening solutions

Groove - Small Pulls

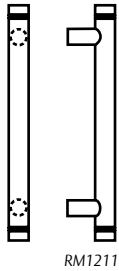

RM1211

Straight - Flat Ends							
Part	Max OA	Dia.	3/605 4/606	10/612 10B/613	Stock PC 10BE	32D/630	32/629
RM1211-5	6 7/8"	5/8"	83	90	78	53	60
RM1211-6	7 7/8"	5/8"	84	91	79	54	61
RM1211-7	8 7/8"	5/8"	85	92	80	56	62
RM1211-8	9 7/8"	5/8"	87	94	82	57	63
RM1211-10	11 7/8"	5/8"	95	102	83	58	64
RM1211-12	13 7/8"	5/8"	100	109	86	61	68

GripZone - Small Pulls for Cabinets, Casework & Closet Doors

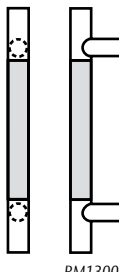

RM1300

Straight - Flat Ends			
Part	Max OA	Dia.	32/629
RM1300-4	5 7/8"	1/2"	62
RM1300-5	6 7/8"	1/2"	63
RM1300-6	7 7/8"	1/2"	64
RM1300-8	9 7/8"	1/2"	65
RM1300-10	11 7/8"	1/2"	68
RM1300-12	13 7/8"	1/2"	73
RM1300-18	19 7/8"	1/2"	77
RM1300-24	25 7/8"	1/2"	88
RM1300-30	31 7/8"	1/2"	97

Straight - Flat Ends			
Part	Max OA	Dia.	32/629
RM1310-5	6 7/8"	5/8"	70
RM1310-6	7 7/8"	5/8"	71
RM1310-7	8 7/8"	5/8"	72
RM1310-8	9 7/8"	5/8"	73
RM1310-10	11 7/8"	5/8"	75
RM1310-12	13 7/8"	5/8"	77
RM1310-18	19 7/8"	5/8"	93
RM1310-24	25 7/8"	5/8"	103
RM1310-30	31 7/8"	5/8"	115

Offset - Flat Ends			
Part	Max OA	Dia.	32/629
RM1330-5	6 7/8"	5/8"	103
RM1330-6	7 7/8"	5/8"	104
RM1330-7	8 7/8"	5/8"	105
RM1330-8	9 7/8"	5/8"	109
RM1330-10	11 7/8"	5/8"	111
RM1330-12	13 7/8"	5/8"	115
RM1330-18	19 7/8"	5/8"	127
RM1330-24	25 7/8"	5/8"	139
RM1330-30	31 7/8"	5/8"	148

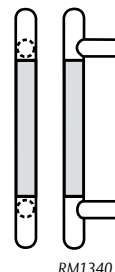

RM1340

Straight - Round Ends			
Part	Max OA	Dia.	32/629
RM1340-4	5 7/8"	1/2"	71
RM1340-5	6 7/8"	1/2"	72
RM1340-6	7 7/8"	1/2"	73
RM1340-8	9 7/8"	1/2"	75
RM1340-10	11 7/8"	1/2"	77
RM1340-12	13 7/8"	1/2"	85
RM1340-18	19 7/8"	1/2"	91
RM1340-24	25 7/8"	1/2"	97
RM1340-30	31 7/8"	1/2"	109

Straight - Round Ends			
Part	Max OA	Dia.	32/629
RM1350-5	6 7/8"	5/8"	82
RM1350-6	7 7/8"	5/8"	83
RM1350-7	8 7/8"	5/8"	84
RM1350-8	9 7/8"	5/8"	85
RM1350-10	11 7/8"	5/8"	88
RM1350-12	13 7/8"	5/8"	91
RM1350-18	19 7/8"	5/8"	103
RM1350-24	25 7/8"	5/8"	115
RM1350-30	31 7/8"	5/8"	123

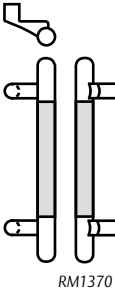

RM1370

Offset - Round Ends			
Part	Max OA	Dia.	32/629
RM1370-5	6 7/8"	5/8"	115
RM1370-6	7 7/8"	5/8"	116
RM1370-7	8 7/8"	5/8"	117
RM1370-8	9 7/8"	5/8"	119
RM1370-10	11 7/8"	5/8"	121
RM1370-12	13 7/8"	5/8"	123
RM1370-18	19 7/8"	5/8"	139
RM1370-24	25 7/8"	5/8"	148
RM1370-30	31 7/8"	5/8"	161

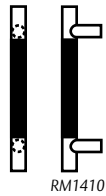

NoirMet - Small Pulls

Straight - Flat Ends							
Part	Max OA	Dia.	3/605 4/606	10/612 10B/613	Stock PC 10BE	32D/630	32/629
RM1410-5	6 7/8"	5/8"	131	142	98	72	80
RM1410-6	7 7/8"	5/8"	134	146	100	74	83
Offset - Flat Ends							
RM1430-5	6 7/8"	5/8"			141	113	128
RM1430-6	7 7/8"	5/8"			143	116	130
Straight - Round Ends							
RM1450-5	6 7/8"	5/8"	156	168	116	89	99
RM1450-6	7 7/8"	5/8"	159	170	120	93	103
Offset - Round Ends							
RM1470-5	6 7/8"	5/8"			161	132	148
RM1470-6	7 7/8"	5/8"			166	137	155

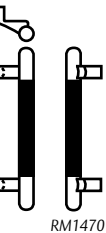

ArborMet - Small Pulls

Straight - Flat Ends							
Part	Max OA	Dia.	3/605 4/606	10/612 10B/613	Stock PC 10BE	32D/630	32/629
RM1510-5	6 7/8"	5/8"	138	149	102	76	87
RM1510-6	7 7/8"	5/8"	141	152	105	80	91
Offset - Flat Ends							
RM1530-5	6 7/8"	5/8"			148	120	136
RM1530-6	7 7/8"	5/8"			151	123	142
Straight - Round Ends							
RM1550-5	6 7/8"	5/8"	162	175	124	97	110
RM1550-6	7 7/8"	5/8"	166	178	127	100	115
Offset - Round Ends							
RM1570-5	6 7/8"	5/8"			168	140	160
RM1570-6	7 7/8"	5/8"			171	142	164

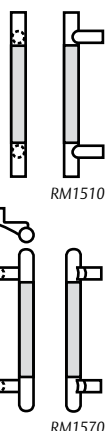

MegaCurve - Long Curved Pulls

Mid Bow								
Part	Max OA	3/605 4/606	10/612 10B/613	Stock PC 10BE	32D/630	32/629	32D316	32316
RM2000	72"	1,831	1,978	1,338	1,151	1,290	1,584	1,767
	84"	1,892	2,044	1,395	1,208	1,352	1,662	1,853
	96"	1,953	2,109	1,454	1,264	1,416	1,739	1,940
RM2004	72"	1,946	2,101	1,436	1,247	1,397	1,716	1,914
	84"	2,006	2,167	1,495	1,303	1,459	1,793	2,000
	96"	2,067	2,232	1,553	1,359	1,523	1,870	2,086
Long Bow Pulls								
RM2010	72"	2,400	2,591	1,835	1,630	1,781	2,187	2,440
	84"	2,460	2,657	1,893	1,646	1,843	2,264	2,526
	96"	2,520	2,722	1,952	1,702	1,907	2,342	2,612
RM2014	72"	2,516	2,717	1,934	1,726	1,933	2,374	2,648
	84"	2,577	2,783	1,993	1,782	1,996	2,451	2,734
	96"	2,637	2,848	2,051	1,838	2,058	2,529	2,820
45° Pulls								
RM2020	72"	1,946	2,101	1,436	1,247	1,397	1,716	1,914
	84"	2,006	2,167	1,495	1,303	1,459	1,793	2,000
	96"	2,067	2,232	1,553	1,359	1,523	1,870	2,086
RM2024	72"	2,060	2,225	1,536	1,342	1,504	1,847	2,060
	84"	2,121	2,290	1,594	1,399	1,567	1,924	2,147
	96"	2,181	2,356	1,653	1,455	1,629	2,002	2,233
Triangle Pulls								
RM2030	72"	1,946	2,101	1,436	1,247	1,397	1,716	1,914
	84"	2,006	2,167	1,495	1,303	1,459	1,793	2,000
	96"	2,067	2,232	1,553	1,359	1,523	1,870	2,086
RM2034	72"	2,060	2,225	1,536	1,342	1,504	1,847	2,060
	84"	2,121	2,290	1,594	1,399	1,567	1,924	2,147
	96"	2,181	2,356	1,653	1,455	1,629	2,002	2,233

• Add \$6.50/in. over 96".

ASSA ABLOY

Opening Solutions

The global leader in door opening solutions

MezzoTek - Necked Post Pulls

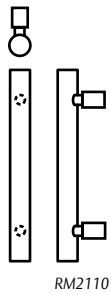

RM2110

Straight Pulls without GripZone									
Part	Max OA	Dia.	3/605 4/606	10/612 10B/613	Stock PC 10BE	32D/630	32/629	32D316	32316
RM2110	12"	1 1/4"	526	570	312	214	240	295	330
	24"	1 1/4"	570	615	368	268	300	369	412
	36"	1 1/4"	612	661	423	321	360	443	494
	48"	1 1/4"	654	707	479	375	420	517	577
	60"	1 1/4"	682	736	516	410	460	566	630
	72"	1 1/4"	710	767	574	445	499	615	684
	84"	1 1/4"	739	797	611	481	539	664	739
RM2120	12"	1 1/2"	573	618	324	226	253	312	347
	24"	1 1/2"	615	664	380	280	313	385	430
	36"	1 1/2"	657	710	436	333	373	459	512
	48"	1 1/2"	700	756	491	387	433	532	594
	60"	1 1/2"	728	786	527	421	472	580	647
	72"	1 1/2"	756	817	586	457	511	629	702
	84"	1 1/2"	784	847	623	492	550	678	755
96"	1 1/2"	812	877	659	527	591	727	809	



RM2112

Push Bars without GripZone									
RM2112	Up to 36" CTC	1 1/4"	612	661	423	321	360	443	494
RM2122	Up to 36" CTC	1 1/2"	657	710	436	333	373	459	512

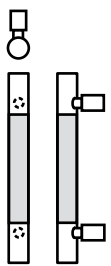

RM2130

Straight Pulls with GripZone									
Part	Max OA	Dia.	3/605	9/611	32/629	32316			
RM2130	12"	1 1/4"	639	722	347	486			
	24"	1 1/4"	681	769	407	568			
	36"	1 1/4"	723	818	468	650			
	48"	1 1/4"	766	865	527	730			
	60"	1 1/4"	794	898	567	782			
	72"	1 1/4"	822	929	606	836			
	84"	1 1/4"	850	961	646	889			
RM2140	12"	1 1/2"	684	774	360	534			
	24"	1 1/2"	727	822	420	626			
	36"	1 1/2"	769	869	480	718			
	48"	1 1/2"	812	917	540	809			
	60"	1 1/2"	839	950	579	870			
	72"	1 1/2"	867	981	618	932			
	84"	1 1/2"	896	1,011	658	992			
96"	1 1/2"	924	1,043	698	1,054				

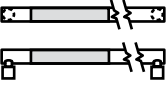

RM2132

Push Bars with GripZone									
RM2132	Up to 36" CTC	1 1/4"	723	818	468	650			
RM2142	Up to 36" CTC	1 1/2"	769	869	480	718			

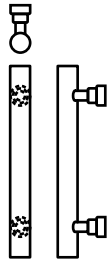

RM2150

Double Stepped Post Pulls									
Part	Max OA	Dia.	3/605 4/606	10/612 10B/613	Stock PC 10BE	32D/630	32/629	32D316	32316
RM2150	12"	1"	408	441	334	235	264	324	362
	24"	1"	473	511	390	289	324	398	444
	36"	1"	538	581	445	342	384	472	527
	48"	1"	603	651	501	397	444	546	609
	60"	1"	667	721	561	432	484	595	664
	72"	1"	732	791	597	468	523	644	718
	84"	1"	797	861	634	503	563	693	772
96"	1"	862	931	671	538	602	742	827	

- Add \$6.50/in. over 96".
- MP (Mid Post) - Add \$76 each (Recommended for maximum rigidity on long door pulls. See page 5 for guidelines.)
- Pulls with GripZone offer an additional aesthetic look, not a tactile feel. The grip zones are satin, the post and end sections are polished. US10B finish is not available on GripZone pulls.

NOTE: Post location on push bars can be located 1/8" from end for narrow & medium stile doors and 1" from end for flush and wide stile doors.

ASSA ABLOY
 Opening Solutions
 The global leader in
 door opening solutions

BandWidth - Collar Mount Pulls

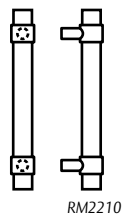

Straight Pulls - Flat Ends							
Part	Max OA	Dia.	3/605 4/606	10/612 10B/613	Stock PC 10BE	32D/630	32/629
RM2200	12"	1"	533	576	481	374	418
	24"	1"	620	668	525	416	467
	36"	1"	708	763	592	459	513
	48"	1"	794	858	636	501	561
	60"	1"	881	951	666	528	592
	72"	1"	967	1,045	694	557	623
	84"	1"	1,055	1,139	723	585	654
	96"	1"	1,142	1,233	752	612	686
RM2210	12"	1 1/4"	571	616	495	386	433
	24"	1 1/4"	655	708	538	428	480
	36"	1 1/4"	740	799	605	471	527
	48"	1 1/4"	823	889	648	512	574
	60"	1 1/4"	907	981	677	540	604
	72"	1 1/4"	992	1,070	706	568	635
	84"	1 1/4"	1,076	1,162	735	596	667
	96"	1 1/4"	1,160	1,254	763	623	698

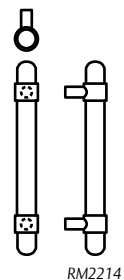

Straight Pulls - Round Ends							
Part	Max OA	Dia.	3/605 4/606	10/612 10B/613	Stock PC 10BE	32D/630	32/629
RM2204	12"	1"	634	685	528	418	469
	24"	1"	722	779	594	461	516
	36"	1"	809	873	638	503	564
	48"	1"	896	967	683	545	611
	60"	1"	982	1,061	712	574	642
	72"	1"	1,069	1,156	740	601	674
	84"	1"	1,157	1,249	770	629	705
	96"	1"	1,243	1,343	798	657	735
RM2214	12"	1 1/4"	673	726	541	431	482
	24"	1 1/4"	756	817	608	473	530
	36"	1 1/4"	840	907	651	515	578
	48"	1 1/4"	925	999	694	557	623
	60"	1 1/4"	1,009	1,091	723	585	654
	72"	1 1/4"	1,093	1,180	752	612	686
	84"	1 1/4"	1,178	1,272	781	640	717
	96"	1 1/4"	1,262	1,362	810	668	748

Offset Pulls - Flat Ends							
Part	Max OA	Dia.	3/605 4/606	10/612 10B/613	Stock PC 10BE	32D/630	32/629
RM2230	12"	1"	581	627	521	412	461
	24"	1"	667	722	588	455	509
	36"	1"	755	815	632	497	557
	48"	1"	843	909	676	538	603
	60"	1"	928	1,003	705	567	634
	72"	1"	1,016	1,097	734	595	666
	84"	1"	1,102	1,191	762	622	697
	96"	1"	1,190	1,285	792	650	728
RM2240	12"	1 1/4"	619	667	533	424	476
	24"	1 1/4"	702	758	601	467	522
	36"	1 1/4"	787	851	645	509	570
	48"	1 1/4"	870	940	688	549	615
	60"	1 1/4"	956	1,032	716	578	646
	72"	1 1/4"	1,039	1,123	746	606	678
	84"	1 1/4"	1,124	1,213	774	633	709
	96"	1 1/4"	1,208	1,304	803	662	740

Offset Pulls - Round Ends							
Part	Max OA	Dia.	3/605 4/606	10/612 10B/613	Stock PC 10BE	32D/630	32/629
RM2234	12"	1"	682	737	590	457	511
	24"	1"	769	830	634	499	559
	36"	1"	857	925	678	541	606
	48"	1"	943	1,019	722	584	653
	60"	1"	1,030	1,112	751	611	685
	72"	1"	1,117	1,206	780	639	716
	84"	1"	1,204	1,301	809	667	747
	96"	1"	1,292	1,394	838	695	778
RM2244	12"	1 1/4"	720	778	603	469	525
	24"	1 1/4"	804	868	647	511	572
	36"	1 1/4"	889	960	691	553	620
	48"	1 1/4"	972	1,050	734	595	666
	60"	1 1/4"	1,057	1,142	762	622	697
	72"	1 1/4"	1,141	1,232	792	650	728
	84"	1 1/4"	1,226	1,324	820	678	760
	96"	1 1/4"	1,309	1,414	849	706	790

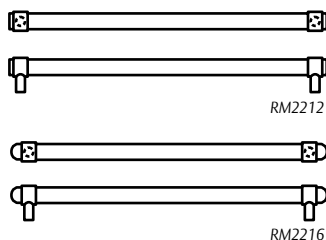
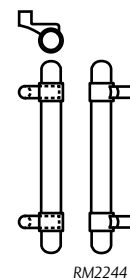
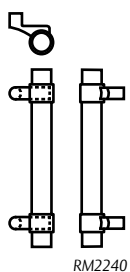

Push Bars - Flat Ends							
Part	Max OA	Dia.	3/605 4/606	10/612 10B/613	Stock PC 10BE	32D/630	32/629
RM2202	Up to 36" CTC	1"	708	763	592	459	513
RM2212	Up to 36" CTC	1 1/4"	740	799	605	471	527
Push Bars - Round Ends							
RM2206	Up to 36" CTC	1"	809	873	638	503	564
RM2216	Up to 36" CTC	1 1/4"	840	907	651	515	578

- Add \$6.50/in. over 96".
- MP (Mid Post) - Add \$108 each (Recommended for maximum rigidity on long door pulls. See page 5 for guidelines.)
- Specify finish of grip and collar.

NOTE: Post location on push bars can be located 1/8" from end for narrow & medium stile doors and 1" from end for flush and wide stile doors.

OvalTek - True Oval Grip

Straight Pulls					
Part	Max OA	Size	Stock PC 10BE	32D/630	32/629
RM2300	12"	1" x 1 1/2"	457	350	393
	24"	1" x 1 1/2"	515	407	456
	36"	1" x 1 1/2"	596	464	519
	48"	1" x 1 1/2"	654	519	582
	60"	1" x 1 1/2"	713	576	644
	72"	1" x 1 1/2"	772	632	708
	84"	1" x 1 1/2"	830	688	771
	96"	1" x 1 1/2"	888	744	833
Offset Pulls					
RM2320	12"	1" x 1 1/2"	497	389	436
	24"	1" x 1 1/2"	578	445	499
	36"	1" x 1 1/2"	636	502	562
	48"	1" x 1 1/2"	695	558	625
	60"	1" x 1 1/2"	753	614	688
	72"	1" x 1 1/2"	812	671	750
	84"	1" x 1 1/2"	870	726	814
	96"	1" x 1 1/2"	928	783	877
Straight Pulls					
RM2310	12"	1 1/8" x 1 7/8"	474	368	411
	24"	1 1/8" x 1 7/8"	540	431	483
	36"	1 1/8" x 1 7/8"	629	495	554
	48"	1 1/8" x 1 7/8"	696	560	626
	60"	1 1/8" x 1 7/8"	762	623	698
	72"	1 1/8" x 1 7/8"	828	687	770
	84"	1 1/8" x 1 7/8"	896	751	841
	96"	1 1/8" x 1 7/8"	962	815	913
Offset Pulls					
RM2330	12"	1 1/8" x 1 7/8"	513	406	455
	24"	1 1/8" x 1 7/8"	603	470	526
	36"	1 1/8" x 1 7/8"	670	533	598
	48"	1 1/8" x 1 7/8"	736	598	670
	60"	1 1/8" x 1 7/8"	802	662	741
	72"	1 1/8" x 1 7/8"	869	725	813
	84"	1 1/8" x 1 7/8"	936	790	885
	96"	1 1/8" x 1 7/8"	1,002	853	955
Push Bars					
RM2302	Up to 36" CTC	1" x 1 1/2"	596	464	519
RM2312	Up to 36" CTC	1 1/8" x 1 7/8"	629	495	554

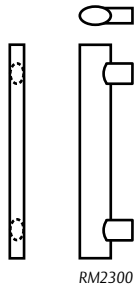

RM2300

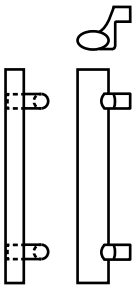

RM2320

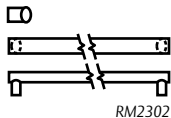

RM2302

OvalTek - Flat Oval Grip

Straight Pulls - Small Round Posts					
Part	Max OA	Size	Stock PC 10BE	32D/630	32/629
RM2400	12"	3/4" x 1 1/2"	505	398	445
	24"	3/4" x 1 1/2"	608	474	531
	36"	3/4" x 1 1/2"	687	550	616
	48"	3/4" x 1 1/2"	765	626	702
	60"	3/4" x 1 1/2"	845	702	787
	72"	3/4" x 1 1/2"	924	779	872
	84"	3/4" x 1 1/2"	1,003	854	957
	96"	3/4" x 1 1/2"	1,105	930	1,042
Straight Pulls - Large Round Posts					
RM2410	12"	3/4" x 1 1/2"	546	436	489
	24"	3/4" x 1 1/2"	648	513	575
	36"	3/4" x 1 1/2"	727	589	660
	48"	3/4" x 1 1/2"	806	665	744
	60"	3/4" x 1 1/2"	885	741	830
	72"	3/4" x 1 1/2"	964	817	915
	84"	3/4" x 1 1/2"	1,066	893	1,000
	96"	3/4" x 1 1/2"	1,146	970	1,086
Straight Pulls - Oblong Posts					
RM2420	12"	3/4" x 1 1/2"	684	547	613
	24"	3/4" x 1 1/2"	762	623	698
	36"	3/4" x 1 1/2"	841	699	783
	48"	3/4" x 1 1/2"	921	776	869
	60"	3/4" x 1 1/2"	1,000	851	953
	72"	3/4" x 1 1/2"	1,101	927	1,038
	84"	3/4" x 1 1/2"	1,181	1,004	1,124
	96"	3/4" x 1 1/2"	1,260	1,080	1,209
Push Bar - Large Round Posts					
RM2402	Up to 36" CTC	3/4" x 1 1/2"	727	589	660

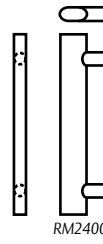

RM2400

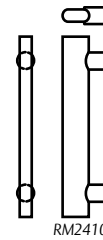

RM2410

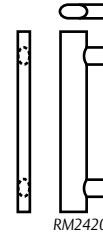

RM2420

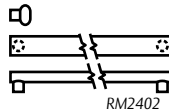





RM2402

- RM2310 & RM2410 pulls add \$7.60/in. over 96".
- MP (Mid Post) - Add \$108 each (Recommended for maximum rigidity on long door pulls. See page 5 for guidelines.)

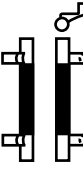

NOTE: Post location on push bars can be located 1/8" from end for narrow & medium stile doors and 1" from end for flush and wide stile doors.

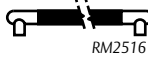
SoftMet - Santoprene™ Grip

Straight Pulls - Flat Ends							
Part	Max OA	Dia.	3/605 4/606	10/612 10B/613	Stock PC 10BE	32D/630	32/629
 RM2510	12"	1 1/4"	438	473	436	329	369
	24"	1 1/4"	567	612	543	432	485
	36"	1 1/4"	695	751	674	536	600
	48"	1 1/4"	824	890	770	639	716
	60"	1 1/4"	953	1,029	877	742	831
	72"	1 1/4"	1,082	1,168	1,005	845	946
	84"	1 1/4"	1,210	1,307	1,112	948	1,063
Offset Pulls - Flat Ends							
 RM2540	12"	1 1/4"	481	519	477	369	413
	24"	1 1/4"	610	658	607	472	528
	36"	1 1/4"	737	797	715	576	644
	48"	1 1/4"	866	935	811	679	761
	60"	1 1/4"	995	1,074	918	782	876
	72"	1 1/4"	1,124	1,214	1,046	885	991
	84"	1 1/4"	1,252	1,353	1,153	988	1,106
Straight Pulls - Round Ends							
 RM2514	12"	1 1/4"	536	578	482	374	419
	24"	1 1/4"	664	717	613	478	535
	36"	1 1/4"	792	856	720	581	650
	48"	1 1/4"	921	995	816	684	766
	60"	1 1/4"	1,050	1,134	923	787	881
	72"	1 1/4"	1,178	1,273	1,051	890	997
	84"	1 1/4"	1,307	1,412	1,158	993	1,112
Offset Pulls - Round Ends							
 RM2544	12"	1 1/4"	578	624	523	413	463
	24"	1 1/4"	707	763	654	517	579
	36"	1 1/4"	835	902	761	620	695
	48"	1 1/4"	964	1,041	857	723	810
	60"	1 1/4"	1,093	1,180	985	826	925
	72"	1 1/4"	1,222	1,319	1,092	929	1,040
	84"	1 1/4"	1,350	1,458	1,199	1,032	1,156
Push Bars							
 RM2512	Up to 36" CTC	1 1/4"	695	751	674	536	600
	Up to 36" CTC	1 1/4"	792	856	720	581	650
 RM2516							

NOTE: Post location on push bars can be located 1/8" from end for narrow & medium stile doors and 1" from end for flush and wide stile doors.

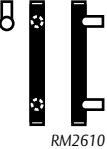
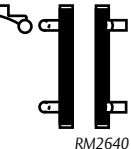
SoftTek - Santoprene™ Grip

Straight Pulls							
Part	Max OA	Dia.	3/605 4/606	10/612 10B/613	Stock PC 10BE	32D/630	32/629
 RM2610	12"	1 1/4"	394	426	423	317	355
	24"	1 1/4"	516	557	526	416	466
	36"	1 1/4"	638	688	652	514	577
	48"	1 1/4"	759	820	742	613	687
	60"	1 1/4"	881	951	845	712	798
	72"	1 1/4"	1,002	1,083	969	811	908
	84"	1 1/4"	1,124	1,213	1,072	910	1,020
Offset Pulls							
 RM2640	12"	1 1/4"	437	472	464	357	399
	24"	1 1/4"	558	603	590	456	510
	36"	1 1/4"	680	734	693	553	620
	48"	1 1/4"	801	865	783	652	731
	60"	1 1/4"	923	997	886	751	841
	72"	1 1/4"	1,044	1,128	1,010	850	952
	84"	1 1/4"	1,166	1,260	1,113	949	1,064
Push Bar							
 RM2612	Up to 36" CTC	1 1/4"	638	688	652	514	577

*Santoprene™ is a registered trademark of the Exxon Mobil Corporation.

ASSA ABLOY

Opening Solutions

The global leader in door opening solutions

NeoMetrix - with GripZone

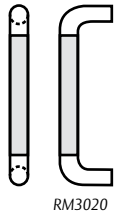

Straight Pulls						
Part	CTC	Dia.	3/605	9/611	32/629	32316
RM3010	12"	1"	364	410	220	339
	24"	1"	449	507	268	411
	36"	1"	534	603	314	484
RM3020	12"	1 1/4"	398	449	233	359
	24"	1 1/4"	480	542	281	432
	36"	1 1/4"	563	637	327	503
RM3030	12"	1 1/2"	466	526	260	399
	24"	1 1/2"	544	614	310	477
	36"	1 1/2"	621	701	362	555

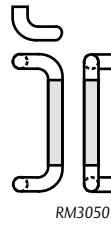

Offset Pulls						
Part	CTC	Dia.	3/605	9/611	32/629	32316
RM3040	12"	1"	406	458	256	392
	24"	1"	491	555	303	465
	36"	1"	576	651	349	537
RM3050	12"	1 1/4"	441	497	269	413
	24"	1 1/4"	522	590	316	485
	36"	1 1/4"	606	685	363	556
RM3060	12"	1 1/2"	509	575	295	454
	24"	1 1/2"	586	662	345	530
	36"	1 1/2"	663	750	397	609

NOTE: Post location on push bars can be located 1/8" from end for narrow & medium stile doors and 1" from end for flush and wide stile doors.

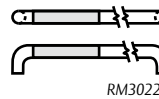

Push Bars - 7" Grip						
RM3012	Up to 36"	1"	534	603	314	484
RM3022	Up to 36"	1 1/4"	563	637	327	503
RM3032	Up to 36"	1 1/2"	621	701	362	555

Groove - Straight & Offset Pulls

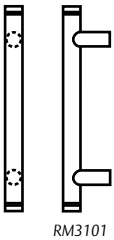

Straight Pulls - Flat Ends							
Part	Max OA	Dia.	3/605 4/606	10/612 10B/613	Stock PC 10BE	32D/630	32/629
RM3101	12"	1"	421	454	250	185	207
	24"	1"	466	503	328	227	255
	36"	1"	510	551	372	269	301
	48"	1"	555	599	415	311	348
	60"	1"	584	631	444	338	379
	72"	1"	614	662	473	366	410
	84"	1"	643	694	501	394	441
	96"	1"	673	726	529	421	472

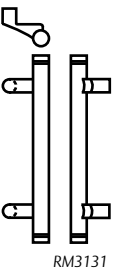

Offset Pulls - Flat Ends							
RM3131	12"	1"	462	499	290	224	250
	24"	1"	507	547	368	266	298
	36"	1"	551	595	412	308	344
	48"	1"	596	644	455	349	392
	60"	1"	625	676	484	377	422
	72"	1"	655	708	512	405	453
	84"	1"	684	739	541	432	484
	96"	1"	714	770	592	460	515

MegaTek - Straight & Offset PostMount Pulls

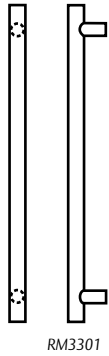

RM3300

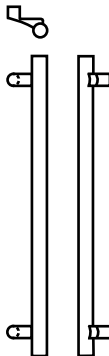

RM3311

Straight Pulls - Flat Ends (87" max overall in aluminum, specify CTC and overall length.)											
Part	Max OA	Dia.	28/628	313/710 315/711	3/605 4/606	10/612 10B/613	Stock PC 10BE	32D/630	32/629	32D316	32316
RM3300	12"	1"	134	148	349	377	196	135	152	187	209
	24"	1"	176	189	391	422	238	176	197	243	272
	36"	1"	217	232	433	469	313	216	242	298	333
	48"	1"	235	279	475	513	355	257	288	355	396
	60"	1"	263	306	503	543	383	284	317	390	438
	72"	1"	290	334	529	573	411	310	347	427	478
	84"	1"	318	362	557	603	438	336	377	464	520
	96"	1"			585	632	465	363	406	500	561
RM3301	12"	1 1/4"	153	169	365	394	209	147	166	204	229
	24"	1 1/4"	196	211	407	440	250	188	210	259	289
	36"	1 1/4"	237	253	448	485	326	228	256	315	353
	48"	1 1/4"	279	323	490	529	366	268	299	369	413
	60"	1 1/4"	306	351	518	559	394	294	329	405	453
	72"	1 1/4"	334	379	545	589	421	320	359	442	494
	84"	1 1/4"	362	406	573	619	449	347	389	478	536
	96"	1 1/4"			600	649	477	374	418	515	576
RM3302	12"	1 1/2"	177	240	348	376	222	161	180	220	248
	24"	1 1/2"	218	283	390	421	264	201	225	277	310
	36"	1 1/2"	261	324	432	466	339	240	270	332	371
	48"	1 1/2"	332	366	505	545	378	279	313	385	432
	60"	1 1/2"	360	394	531	575	406	306	342	420	472
	72"	1 1/2"	387	421	559	605	434	332	373	458	513
	84"	1 1/2"	415	449	587	634	461	359	402	494	554
	96"	1 1/2"			614	664	488	385	432	530	595
Offset Pulls - Flat Ends (Specify CTC and overall length.)											
RM3310	12"	1"	166	180	388	419	227	166	186	219	242
	24"	1"	207	221	430	464	269	206	230	276	305
	36"	1"	249	264	472	509	344	246	276	331	365
	48"	1"	265	308	513	554	384	285	318	385	426
	60"	1"	293	336	541	584	412	311	348	420	468
	72"	1"	320	364	569	613	439	337	378	458	509
	84"	1"	348	391	595	643	466	364	407	494	550
	96"	1"			623	673	495	391	437	530	591
RM3311	12"	1 1/4"	185	201	403	434	240	179	200	236	261
	24"	1 1/4"	228	243	444	479	315	218	245	291	321
	36"	1 1/4"	269	285	486	524	357	259	290	347	385
	48"	1 1/4"	308	353	527	570	396	296	331	399	443
	60"	1 1/4"	336	381	555	599	423	322	361	436	484
	72"	1 1/4"	364	408	583	628	452	349	391	472	524
	84"	1 1/4"	391	436	610	658	479	376	420	509	566
	96"	1 1/4"			638	688	506	402	449	546	606
RM3312	12"	1 1/2"	208	272	388	419	253	190	212	253	280
	24"	1 1/2"	250	315	430	464	328	230	258	309	343
	36"	1 1/2"	293	356	472	509	370	271	303	364	404
	48"	1 1/2"	362	396	543	587	407	307	343	415	462
	60"	1 1/2"	389	423	571	617	435	333	374	451	502
	72"	1 1/2"	417	451	597	646	462	360	403	488	543
	84"	1 1/2"	445	479	625	676	489	386	433	524	584
	96"	1 1/2"			653	706	518	413	463	562	625

- Add \$6.50/in. over 96".
- MP (Mid Post) - Add \$76 each (Recommended for maximum rigidity on long door pulls. See page 5 for guidelines.)

ASSA ABLOY
 Opening Solutions
 The global leader in
 door opening solutions

MegaTek - Straight & Offset PostMount Pulls (con't)

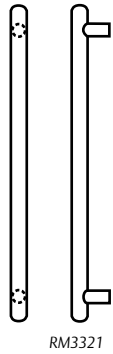

RM3321

Straight Pulls - Round Ends (90" max overall in aluminum, specify CTC and overall length.)											
Part	Max OA	Dia.	28/628	313/710 315/711	3/605 4/606	10/612 10B/613	Stock PC 10BE	32D/630	32/629	32D316	32316
RM3320	12"	1"	169	183	433	469	234	172	192	237	264
	24"	1"	211	225	475	513	309	212	237	292	328
	36"	1"	253	267	517	558	351	253	284	347	390
	48"	1"	271	316	558	604	390	290	324	399	447
	60"	1"	299	344	586	633	417	316	355	436	488
	72"	1"	327	371	613	662	444	342	384	472	529
	84"	1"	354	398	641	692	473	370	414	509	570
	96"	1"			668	722	500	396	443	546	610
RM3321	12"	1 1/4"	191	205	448	485	247	185	207	254	286
	24"	1 1/4"	234	247	490	529	322	225	251	310	346
	36"	1 1/4"	276	289	531	575	364	266	297	365	410
	48"	1 1/4"	316	361	574	620	401	301	337	415	465
	60"	1 1/4"	344	388	602	650	429	328	368	452	506
	72"	1 1/4"	371	416	628	679	457	355	397	488	547
	84"	1 1/4"	398	444	656	709	484	381	426	525	589
	96"	1 1/4"			684	739	511	407	457	562	629
RM3322	12"	1 1/2"	212	228	439	474	272	209	234	288	322
	24"	1 1/2"	254	269	480	519	348	249	279	344	385
	36"	1 1/2"	296	312	522	563	390	290	324	399	447
	48"	1 1/2"	332	366	594	642	424	323	363	446	500
	60"	1 1/2"	360	394	622	672	453	350	393	483	541
	72"	1 1/2"	387	421	650	701	480	377	422	520	581
	84"	1 1/2"	415	449	677	731	507	403	452	555	623
	96"	1 1/2"			705	760	558	429	482	593	664

Offset Pulls - Round Ends (Specify CTC and overall length.)											
RM3330	12"	1"	200	214	470	507	266	203	227	268	295
	24"	1"	241	256	511	552	341	243	272	323	359
	36"	1"	284	298	553	596	383	284	317	379	422
	48"	1"	300	345	594	642	419	318	357	428	477
	60"	1"	328	372	622	672	446	344	386	465	517
	72"	1"	355	400	650	701	475	372	416	501	560
	84"	1"	383	427	677	731	502	398	445	538	599
	96"	1"			705	760	551	424	476	575	640
RM3331	12"	1 1/4"	223	236	485	523	311	214	239	286	317
	24"	1 1/4"	265	278	526	569	353	255	286	342	378
	36"	1 1/4"	306	320	569	613	395	295	330	397	441
	48"	1 1/4"	345	389	610	658	431	329	369	444	494
	60"	1 1/4"	372	417	638	688	458	356	398	482	536
	72"	1 1/4"	400	445	665	718	485	382	427	517	576
	84"	1 1/4"	427	472	692	748	513	408	458	554	618
	96"	1 1/4"			720	777	563	435	487	591	658
RM3332	12"	1 1/2"	243	258	478	517	337	239	269	319	355
	24"	1 1/2"	285	300	520	561	379	280	314	375	416
	36"	1 1/2"	327	342	561	607	421	320	359	431	479
	48"	1 1/2"	361	395	632	683	454	351	394	475	529
	60"	1 1/2"	388	422	659	712	481	378	423	512	570
	72"	1 1/2"	416	450	687	742	508	404	453	549	610
	84"	1 1/2"	444	478	715	771	559	431	483	584	652
	96"	1 1/2"			742	801	586	458	512	622	693

- Add \$6.50/in. over 96".
- MP (Mid Post) - Add \$76 each (Recommended for maximum rigidity on long door pulls. See page 5 for guidelines.)

MegaTek - Straight & Offset PostMount Pulls (con't)

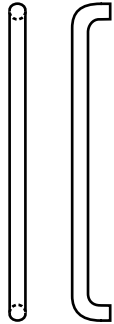

RM3341

Straight Pulls - Bent Ends (86" max CTC in aluminum, specify CTC.)											
Part	CTC	Dia.	28/628	313/710 315/711	3/605 4/606	10/612 10B/613	Stock PC 10BE	32D/630	32/629	32D316	32316
RM3340	12"	1"	127	140	291	314	184	124	139	171	191
	24"	1"	160	177	333	359	226	165	185	227	254
	36"	1"	194	213	375	405	268	205	229	282	316
	48"	1"	227	249	416	449	343	245	275	337	379
	60"	1"	260	286	454	490	361	262	294	361	405
	72"	1"	293	322	490	529	378	279	313	385	432
	84"	1"	325	358	579	625	414	313	350	431	483
	96"	1"			668	722	448	345	387	477	535
RM3341	12"	1 1/4"	138	152	349	377	196	135	152	187	209
	24"	1 1/4"	171	188	391	422	238	176	197	243	272
	36"	1 1/4"	204	225	433	469	313	216	242	298	333
	48"	1 1/4"	237	262	475	513	355	257	288	355	396
	60"	1 1/4"	270	298	512	553	373	274	306	376	420
	72"	1 1/4"	303	334	550	593	390	290	324	399	447
	84"	1 1/4"	336	371	646	698	424	323	362	445	498
	96"	1 1/4"			743	802	459	357	399	492	550
RM3342	12"	1 1/2"	154	170	424	458	231	169	189	233	260
	24"	1 1/2"	187	206	466	504	272	209	234	288	322
	36"	1 1/2"	220	243	508	548	348	249	279	344	385
	48"	1 1/2"	254	279	550	593	390	290	324	399	447
	60"	1 1/2"	287	316	588	634	401	301	337	415	465
	72"	1 1/2"	320	352	625	676	413	312	349	430	482
	84"	1 1/2"	353	388	715	770	448	345	387	475	535
	96"	1 1/2"			802	866	482	379	424	522	584

Push Bars - Flat Ends

	RM3102	Up to 36" CTC	1"	217	232	433	469	313	216	242	298	333
	RM3112	Up to 36" CTC	1 1/4"	237	253	448	485	326	228	256	315	353
	RM3122	Up to 36" CTC	1 1/2"	261	324	432	466	339	240	270	332	371

Push Bars - Round Ends

	RM3106	Up to 36" CTC	1"	253	267	517	558	351	253	284	347	390
	RM3116	Up to 36" CTC	1 1/4"	276	289	531	575	364	266	297	365	410
	RM3126	Up to 36" CTC	1 1/2"	296	312	522	563	390	290	324	399	447

- Add \$6.50/in. over 96".
- Add \$6.50/in. over 36" on Push Bars.
- MP (Mid Post) - Add \$76 each (Recommended for maximum rigidity on long door pulls. See page 5 for guidelines.)

NOTE: Post location on push bars can be located 1/8" from end for narrow & medium stile doors and 1" from end for flush and wide stile doors.

Quick Ship MegaTek - Straight PostMount Pulls

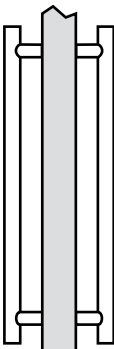

RM3301BTB

Straight Pulls - Flat Ends - Back-to-Back Mounting				
Part	CTC	OA	Dia.	32D/630
RM3301BTB1224.32D	12"	24"	1 1/4"	398
RM3301BTB2436.32D	24"	36"	1 1/4"	479
RM3301BTB3648.32D	36"	48"	1 1/4"	558
RM3301BTB4860.32D	48"	60"	1 1/4"	610
RM3301BTB6072.32D	60"	72"	1 1/4"	664
RM3301BTB7284.32D	72"	84"	1 1/4"	716
RM3301BTB8496.32D	84"	96"	1 1/4"	770

- Mounting included for both 1 3/4" wood or metal doors and 1/2" glass doors.

ASSA ABLOY

Opening Solutions

The global leader in
door opening solutions

USA & Canada Prices Effective June 3, 2019

Copyright © 2019, ASSA ABLOY Accessories and Door Controls Group, Inc. All rights reserved. Reproduction in whole or in part without the express written permission of ASSA ABLOY Accessories and Door Controls Group, Inc. is prohibited.

NeoMax - Post Mounted GripZone

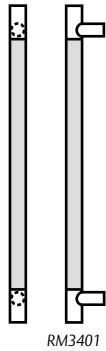

RM3401

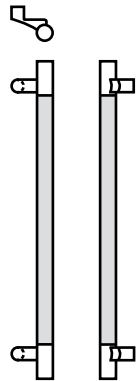

RM3411

Straight Pulls - Flat Ends						
Part	Max OA	Dia.	3/605	9/611	32/629	32316
RM3400	12"	1"	329	371	188	254
	24"	1"	414	468	235	317
	36"	1"	499	564	282	381
	48"	1"	584	660	329	444
	60"	1"	670	756	376	508
	72"	1"	755	852	423	572
	84"	1"	839	950	470	635
	96"	1"	925	1,045	517	699
RM3401	12"	1 ¼"	364	411	201	309
	24"	1 ¼"	445	504	248	381
	36"	1 ¼"	528	596	295	444
	48"	1 ¼"	611	690	342	525
	60"	1 ¼"	694	784	389	597
	72"	1 ¼"	776	877	436	670
	84"	1 ¼"	859	970	483	742
	96"	1 ¼"	941	1,064	530	813
RM3402	12"	1 ½"	432	487	227	307
	24"	1 ½"	509	575	278	374
	36"	1 ½"	586	662	329	453
	48"	1 ½"	663	751	379	513
	60"	1 ½"	742	837	430	582
	72"	1 ½"	819	925	481	649
	84"	1 ½"	896	1,012	532	719
	96"	1 ½"	973	1,100	582	786
Offset Pulls - Flat Ends						
RM3410	12"	1"	371	420	223	301
	24"	1"	456	516	270	364
	36"	1"	541	612	317	428
	48"	1"	627	709	364	492
	60"	1"	713	804	411	555
	72"	1"	798	901	458	619
	84"	1"	883	998	505	682
	96"	1"	968	1,094	551	745
RM3411	12"	1 ¼"	406	459	236	319
	24"	1 ¼"	488	552	283	382
	36"	1 ¼"	572	645	330	445
	48"	1 ¼"	653	739	377	509
	60"	1 ¼"	736	831	424	573
	72"	1 ¼"	819	925	471	636
	84"	1 ¼"	902	1,019	518	700
	96"	1 ¼"	984	1,112	565	763
RM3412	12"	1 ½"	474	536	263	354
	24"	1 ½"	552	623	312	422
	36"	1 ½"	629	711	364	492
	48"	1 ½"	707	798	414	560
	60"	1 ½"	784	886	466	629
	72"	1 ½"	861	973	515	697
	84"	1 ½"	939	1,062	567	765
	96"	1 ½"	1,017	1,148	617	834

- Add \$6.50/in. over 96".
- MP (Mid Post) - Add \$76 each (Recommended for maximum rigidity on long door pulls. See page 5 for guidelines.)

NeoMax - Post Mounted GripZone (con't)

Straight Pulls - Round Ends						
Part	Max OA	Dia.	3/605	9/611	32/629	32316
RM3420	12"	1"	421	475	225	305
	24"	1"	507	573	272	368
	36"	1"	591	668	319	432
	48"	1"	677	764	366	495
	60"	1"	762	861	413	557
	72"	1"	848	958	460	621
	84"	1"	932	1,054	507	685
	96"	1"	1,018	1,149	553	749
RM3421	12"	1 ¼"	455	515	238	321
	24"	1 ¼"	538	609	285	385
	36"	1 ¼"	621	701	332	449
	48"	1 ¼"	703	794	379	513
	60"	1 ¼"	786	888	426	576
	72"	1 ¼"	868	982	473	640
	84"	1 ¼"	952	1,075	520	702
	96"	1 ¼"	1,034	1,168	567	765
RM3422	12"	1 ½"	524	592	265	358
	24"	1 ½"	602	680	314	424
	36"	1 ½"	679	766	366	495
	48"	1 ½"	756	855	416	563
	60"	1 ½"	833	942	468	631
	72"	1 ½"	912	1,029	518	700
	84"	1 ½"	989	1,118	569	770
	96"	1 ½"	1,066	1,205	619	836
Offset Pulls - Round Ends						
RM3430	12"	1"	464	524	260	352
	24"	1"	549	620	307	415
	36"	1"	633	717	354	477
	48"	1"	719	813	401	542
	60"	1"	804	908	447	605
	72"	1"	890	1,006	495	669
	84"	1"	974	1,102	541	732
	96"	1"	1,061	1,198	589	796
RM3431	12"	1 ¼"	500	564	273	369
	24"	1 ¼"	582	658	320	433
	36"	1 ¼"	665	752	367	496
	48"	1 ¼"	747	845	414	560
	60"	1 ¼"	830	938	461	622
	72"	1 ¼"	913	1,031	508	686
	84"	1 ¼"	996	1,124	554	750
	96"	1 ¼"	1,077	1,217	602	813
RM3432	12"	1 ½"	567	641	299	405
	24"	1 ½"	644	727	349	472
	36"	1 ½"	722	816	401	542
	48"	1 ½"	799	903	451	609
	60"	1 ½"	877	991	502	679
	72"	1 ½"	954	1,077	552	748
	84"	1 ½"	1,031	1,166	604	816
	96"	1 ½"	1,109	1,254	654	884

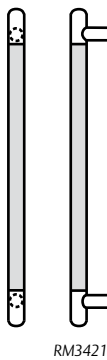

RM3421

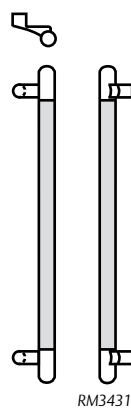

RM3431

- Add \$6.50/in. over 96".
- MP (Mid Post) - Add \$76 each (Recommended for maximum rigidity on long door pulls. See page 5 for guidelines.)

ASSA ABLOY

Opening Solutions

The global leader in door opening solutions

NeoMax - Post Mounted GripZone (con't)

Straight Pulls - Bent Ends (Specify CTC.)						
Part	CTC	Dia.	3/605	9/611	32/629	32316
RM3440	12"	1"	364	411	220	298
	24"	1"	449	507	268	362
	36"	1"	534	603	314	424
	48"	1"	619	699	362	488
	60"	1"	705	795	408	552
	72"	1"	790	892	456	616
	84"	1"	874	989	502	679
RM3441	96"	1"	960	1,085	549	743
	12"	1 1/4"	398	450	233	359
	24"	1 1/4"	480	543	281	432
	36"	1 1/4"	563	636	327	503
	48"	1 1/4"	645	729	375	575
	60"	1 1/4"	728	823	421	648
	72"	1 1/4"	811	916	469	720
RM3442	84"	1 1/4"	894	1,009	515	791
	96"	1 1/4"	976	1,103	563	864
	12"	1 1/2"	466	526	260	352
	24"	1 1/2"	544	614	310	419
	36"	1 1/2"	621	701	362	488
	48"	1 1/2"	698	790	412	556
	60"	1 1/2"	776	877	464	626
	72"	1 1/2"	854	964	513	694
	84"	1 1/2"	931	1,053	565	763
	96"	1 1/2"	1,008	1,139	615	831

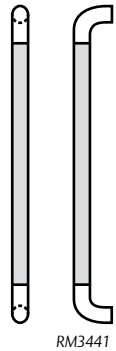

RM3441

Push Bars - Flat Ends (7" Grip)						
Part	CTC	Dia.	3/605	9/611	32/629	32316
RM3202	Up to 36"	1"	499	564	282	381
RM3212	Up to 36"	1 1/4"	528	596	295	444
RM3222	Up to 36"	1 1/2"	586	662	329	453
Push Bars - Round Ends (7" Grip)						
RM3206	Up to 36"	1"	591	668	319	432
RM3216	Up to 36"	1 1/4"	621	701	332	449
RM3226	Up to 36"	1 1/2"	679	766	366	494

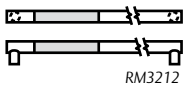

RM3212

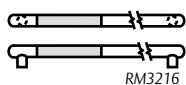

RM3216

LineaMax - Grooved Pulls

Straight Pulls - Solid Flat Ends							
Part	Max OA	Dia.	3/605 4/606	10/612 10B/613	Stock PC 10BE	32D/630	32/629
RM3701	12"	1 1/4"	706	762	491	385	431
	24"	1 1/4"	847	914	603	470	526
	36"	1 1/4"	988	1,066	691	554	621
	48"	1 1/4"	1,129	1,218	779	639	716
	60"	1 1/4"	1,270	1,371	867	724	811
	72"	1 1/4"	1,410	1,523	957	809	907
	84"	1 1/4"	1,551	1,676	1,067	894	1,002
RM3702	96"	1 1/4"	1,692	1,828	1,156	980	1,097
	12"	1 1/2"	850	918	534	425	477
	24"	1 1/2"	1,002	1,083	653	518	581
	36"	1 1/2"	1,156	1,248	750	611	684
	48"	1 1/2"	1,308	1,413	846	704	788
	60"	1 1/2"	1,462	1,578	942	796	892
	72"	1 1/2"	1,614	1,743	1,062	889	996
	84"	1 1/2"	1,766	1,909	1,158	982	1,099
	96"	1 1/2"	1,920	2,073	1,254	1,074	1,203

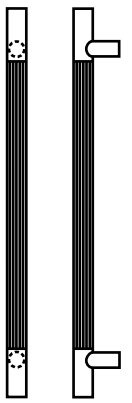

RM3701

- Add \$8.10/in. over 96".
- MP (Mid Post) - Add \$68 each (Recommended for maximum rigidity on long door pulls. See page 5 for guidelines).

LineaMax - Grooved Pulls (con't)

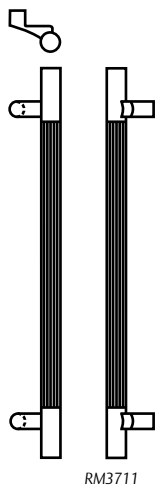

RM3711

Offset Pulls - Solid Flat Ends							
Part	Max OA	Dia.	3/605 4/606	10/612 10B/613	Stock PC 10BE	32D/630	32/629
RM3711	12"	1 1/4"	747	806	532	423	475
	24"	1 1/4"	888	959	643	508	570
	36"	1 1/4"	1,029	1,110	732	593	665
	48"	1 1/4"	1,170	1,263	820	678	760
	60"	1 1/4"	1,310	1,415	908	764	854
	72"	1 1/4"	1,451	1,568	996	848	949
	84"	1 1/4"	1,592	1,720	1,108	933	1,045
RM3712	12"	1 1/2"	891	962	597	465	520
	24"	1 1/2"	1,043	1,127	694	557	624
	36"	1 1/2"	1,197	1,293	790	649	727
	48"	1 1/2"	1,349	1,457	886	742	831
	60"	1 1/2"	1,503	1,622	983	834	935
	72"	1 1/2"	1,655	1,787	1,101	927	1,038
	84"	1 1/2"	1,808	1,953	1,198	1,020	1,142
	96"	1 1/2"	1,961	2,118	1,295	1,113	1,246

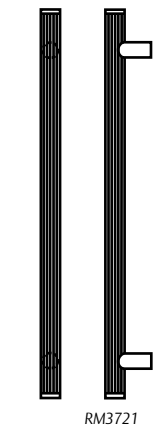

RM3721

Straight Pulls - Fully Grooved Flat Ends							
RM3721	12"	1 1/4"	507	547	385	283	316
	24"	1 1/4"	640	691	469	363	406
	36"	1 1/4"	773	834	575	443	497
	48"	1 1/4"	905	977	659	524	587
	60"	1 1/4"	1,038	1,121	742	604	677
	72"	1 1/4"	1,171	1,265	826	685	767
	84"	1 1/4"	1,304	1,408	910	766	857
RM3722	12"	1 1/2"	552	596	426	322	361
	24"	1 1/2"	691	747	516	408	457
	36"	1 1/2"	830	896	628	494	553
	48"	1 1/2"	968	1,046	717	580	649
	60"	1 1/2"	1,107	1,196	807	666	746
	72"	1 1/2"	1,246	1,345	897	752	842
	84"	1 1/2"	1,384	1,496	986	838	938
	96"	1 1/2"	1,523	1,645	1,098	924	1,035

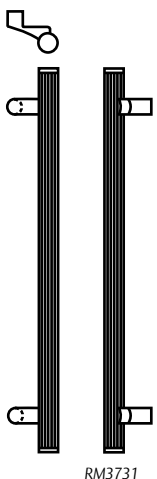

RM3731

Offset Pulls - Fully Grooved Flat Ends							
RM3731	12"	1 1/4"	548	591	425	321	360
	24"	1 1/4"	681	735	509	401	449
	36"	1 1/4"	814	879	615	482	539
	48"	1 1/4"	947	1,022	699	563	630
	60"	1 1/4"	1,079	1,165	783	643	720
	72"	1 1/4"	1,212	1,309	866	723	810
	84"	1 1/4"	1,345	1,452	950	804	900
RM3732	12"	1 1/2"	593	641	466	361	404
	24"	1 1/2"	732	791	579	446	500
	36"	1 1/2"	871	940	669	532	597
	48"	1 1/2"	1,009	1,091	758	618	693
	60"	1 1/2"	1,148	1,240	847	705	789
	72"	1 1/2"	1,288	1,391	937	791	886
	84"	1 1/2"	1,426	1,540	1,026	877	982
	96"	1 1/2"	1,565	1,690	1,138	963	1,079

- Add \$8.10/in. over 96".
- MP (Mid Post) - Add \$68 each (Recommended for maximum rigidity on long door pulls. See page 5 for guidelines).

ASSA ABLOY

Opening Solutions

The global leader in door opening solutions

LineaMax - Grooved Pulls (con't)

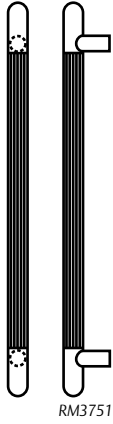
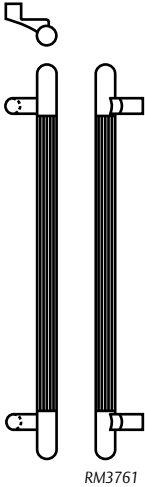
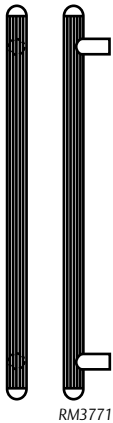
Straight Pulls - Solid Round Ends							
Part	Max OA	Dia.	3/605 4/606	10/612 10B/613	Stock PC 10BE	32D/630	32/629
 RM3751	12"	1 1/4"	799	863	549	440	493
	24"	1 1/4"	940	1,016	660	525	588
	36"	1 1/4"	1,082	1,168	749	610	683
	48"	1 1/4"	1,223	1,320	837	695	778
	60"	1 1/4"	1,364	1,473	925	780	874
	72"	1 1/4"	1,505	1,625	1,013	865	969
	84"	1 1/4"	1,646	1,778	1,125	949	1,064
	96"	1 1/4"	1,787	1,929	1,213	1,034	1,158
	RM3752	12"	1 1/2"	943	1,020	614	481
24"		1 1/2"	1,097	1,185	711	574	642
36"		1 1/2"	1,249	1,349	807	666	746
48"		1 1/2"	1,402	1,514	903	759	849
60"		1 1/2"	1,555	1,680	1,000	851	953
72"		1 1/2"	1,708	1,845	1,119	944	1,057
84"		1 1/2"	1,861	2,010	1,215	1,036	1,160
96"		1 1/2"	2,014	2,174	1,311	1,129	1,265
Offset Pulls - Solid Round Ends							
 RM3761	12"	1 1/4"	840	907	612	479	536
	24"	1 1/4"	982	1,060	700	564	631
	36"	1 1/4"	1,123	1,212	789	648	726
	48"	1 1/4"	1,264	1,365	877	733	821
	60"	1 1/4"	1,405	1,517	965	818	916
	72"	1 1/4"	1,546	1,670	1,076	903	1,011
	84"	1 1/4"	1,687	1,822	1,164	988	1,107
	96"	1 1/4"	1,828	1,975	1,253	1,073	1,202
	RM3762	12"	1 1/2"	985	1,064	654	519
24"		1 1/2"	1,138	1,229	751	612	686
36"		1 1/2"	1,291	1,394	847	705	789
48"		1 1/2"	1,443	1,559	944	797	893
60"		1 1/2"	1,597	1,724	1,063	890	997
72"		1 1/2"	1,749	1,889	1,159	983	1,101
84"		1 1/2"	1,902	2,054	1,256	1,076	1,204
96"		1 1/2"	2,055	2,219	1,351	1,168	1,308
Straight Pulls - Fully Grooved Round Ends							
 RM3771	12"	1 1/4"	600	649	442	337	378
	24"	1 1/4"	733	792	526	418	468
	36"	1 1/4"	866	935	633	498	559
	48"	1 1/4"	999	1,079	716	579	648
	60"	1 1/4"	1,132	1,223	800	660	738
	72"	1 1/4"	1,265	1,366	884	740	829
	84"	1 1/4"	1,398	1,509	967	820	919
	96"	1 1/4"	1,531	1,653	1,074	901	1,009
	RM3772	12"	1 1/2"	647	698	484	377
24"		1 1/2"	785	848	596	464	519
36"		1 1/2"	924	998	686	549	615
48"		1 1/2"	1,063	1,147	775	635	711
60"		1 1/2"	1,201	1,298	864	721	808
72"		1 1/2"	1,340	1,447	953	807	904
84"		1 1/2"	1,479	1,598	1,066	893	1,000
96"		1 1/2"	1,617	1,747	1,156	980	1,097

- Add \$8.10/in. over 96".
- MP (Mid Post) - Add \$68 each (Recommended for maximum rigidity on long door pulls. See page 5 for guidelines).

LineaMax - Grooved Pulls (con't)

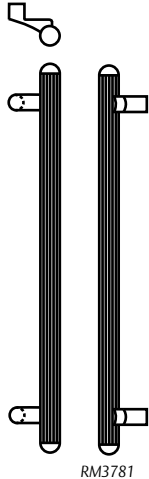

RM3781

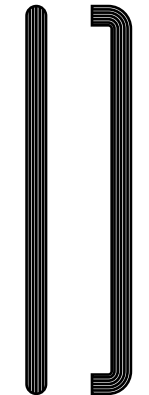

RM3741



RM3512



RM3516



RM3612



RM3616

Offset Pulls - Fully Grooved Round Ends							
Part	Max OA	Dia.	3/605 4/606	10/612 10B/613	Stock PC 10BE	32D/630	32/629
RM3781	12"	1 1/4"	642	693	483	376	421
	24"	1 1/4"	775	836	589	457	511
	36"	1 1/4"	907	981	673	537	602
	48"	1 1/4"	1,040	1,124	757	617	692
	60"	1 1/4"	1,173	1,267	840	698	782
	72"	1 1/4"	1,306	1,410	924	779	872
	84"	1 1/4"	1,439	1,554	1,008	860	963
	96"	1 1/4"	1,572	1,697	1,114	939	1,052
RM3782	12"	1 1/2"	688	743	524	416	466
	24"	1 1/2"	826	892	636	502	562
	36"	1 1/2"	965	1,042	726	588	659
	48"	1 1/2"	1,104	1,192	815	674	754
	60"	1 1/2"	1,242	1,342	904	760	851
	72"	1 1/2"	1,381	1,491	994	845	947
	84"	1 1/2"	1,520	1,642	1,107	932	1,043
	96"	1 1/2"	1,658	1,791	1,196	1,018	1,140
Straight Pulls - Fully Grooved Bent Ends							
RM3741	12"	1 1/4"				315	354
	24"	1 1/4"				396	443
	36"	1 1/4"				477	533
	48"	1 1/4"				557	624
	60"	1 1/4"				637	714
	72"	1 1/4"				718	804
	84"	1 1/4"				798	894
	96"	1 1/4"				879	985
RM3742	12"	1 1/2"				356	398
	24"	1 1/2"				441	494
	36"	1 1/2"				527	591
	48"	1 1/2"				613	687
	60"	1 1/2"				699	783
	72"	1 1/2"				785	880
	84"	1 1/2"				872	976
	96"	1 1/2"				957	1,072
Push Bars Solid Grooves Flat Ends							
RM3512	Up to 36" CTC	1 1/4"	988	1,066	691	554	621
RM3522	Up to 36" CTC	1 1/2"	1,156	1,248	750	611	684
Push Bars Solid Grooves Round Ends							
RM3516	Up to 36" CTC	1 1/4"	1,082	1,168	749	610	683
RM3526	Up to 36" CTC	1 1/2"	1,249	1,349	807	666	746
Push Bars Fully Grooved - Flat Ends							
RM3612	Up to 36" CTC	1 1/4"	773	834	575	443	497
RM3622	Up to 36" CTC	1 1/2"	830	896	628	494	553
Push Bars Fully Grooved - Round Ends							
RM3616	Up to 36" CTC	1 1/4"	866	935	633	498	559
RM3626	Up to 36" CTC	1 1/2"	924	998	686	549	615

- Add \$8.10/in. over 96".
- MP (Mid Post) - Add \$68 each (Recommended for maximum rigidity on long door pulls. See page 5 for guidelines).

NoirMet - Black Anodized Grip with Contrasting Ends and Posts

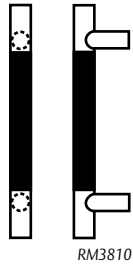

RM3810

Straight Pulls - Flat Ends									
Part	Max OA	Dia.	3/605 4/606	10/612 10B/613	Stock PC 10BE	32D	32/629	32D316	32316
RM3800	12"	1"	353	408	355	256	282	353	388
	24"	1"	385	438	380	281	309	387	425
	36"	1"	398	451	395	296	325	406	447
	48"	1"	592	647	488	387	426	532	586
	60"	1"	644	688	510	409	450	562	619
	72"	1"	693	729	531	430	473	591	651
	84"	1"	792	837	584	458	504	631	693
	96"	1"	891	945	612	486	534	668	735
	RM3810	12"	1 1/4"	372	424	362	264	289	363
24"		1 1/4"	424	458	395	296	325	406	447
36"		1 1/4"	441	476	410	310	341	426	469
48"		1 1/4"	593	647	505	404	443	555	610
60"		1 1/4"	626	672	521	419	461	577	635
72"		1 1/4"	659	695	538	436	479	599	658
84"		1 1/4"	784	819	614	488	538	671	739
96"		1 1/4"	909	941	667	540	593	742	815
RM3820		12"	1 1/2"	460	494	410	310	341	426
	24"	1 1/2"	512	546	436	336	369	462	508
	36"	1 1/2"	556	591	471	371	408	510	561
	48"	1 1/2"	632	649	539	437	480	600	660
	60"	1 1/2"	690	709	594	469	516	644	709
	72"	1 1/2"	748	767	626	500	550	687	756
	84"	1 1/2"	857	876	679	552	608	760	835
	96"	1 1/2"	965	983	734	605	665	831	915

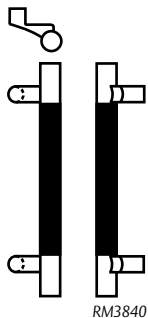

RM3840

Offset Pulls - Flat Ends									
RM3830	12"	1"	398	494	395	296	325	406	447
	24"	1"	472	560	441	341	376	469	516
	36"	1"	557	633	488	387	426	532	586
	48"	1"	641	708	534	433	477	595	656
	60"	1"	692	749	558	455	501	625	688
	72"	1"	742	790	602	476	523	654	720
	84"	1"	842	898	643	516	568	709	780
	96"	1"	939	1,005	683	554	610	762	838
	RM3840	12"	1 1/4"	415	512	402	303	333	416
24"		1 1/4"	499	574	448	348	383	479	526
36"		1 1/4"	571	641	495	393	432	541	594
48"		1 1/4"	642	708	540	438	481	602	661
60"		1 1/4"	675	732	557	454	500	624	687
72"		1 1/4"	708	756	595	470	517	646	710
84"		1 1/4"	832	880	649	522	575	719	792
96"		1 1/4"	958	1,002	702	574	631	789	868
RM3850		12"	1 1/2"	503	583	450	350	386	482
	24"	1 1/2"	556	633	471	371	408	510	561
	36"	1 1/2"	619	673	523	421	465	579	639
	48"	1 1/2"	681	710	596	471	518	648	712
	60"	1 1/2"	740	769	630	503	553	692	761
	72"	1 1/2"	796	828	662	534	588	735	809
	84"	1 1/2"	905	935	715	587	645	807	887
	96"	1 1/2"	1,014	1,043	769	640	703	879	967

• Add \$6.50/in. over 36".

NOTE: Post location on push bars can be located 1/8" from end for narrow & medium stile doors and 1" from end for flush and wide stile doors.

NoirMet - Black Anodized Grip with Contrasting Ends and Posts (con't)

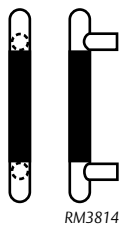

Straight Pulls - Round Ends									
Part	Max OA	Dia.	3/605 4/606	10/612 108/613	Stock PC 10BE	32D	32/629	32D316	32316
RM3804	12"	1"	398	451	395	296	325	406	447
	24"	1"	428	482	423	323	355	445	489
	36"	1"	441	494	436	336	369	462	508
	48"	1"	638	690	534	433	477	595	656
	60"	1"	687	732	558	455	501	625	688
	72"	1"	735	771	603	477	524	656	721
	84"	1"	834	879	644	517	569	710	781
RM3814	96"	1"	931	985	684	556	612	764	841
	12"	1 1/4"	415	469	402	303	333	416	457
	24"	1 1/4"	470	504	435	335	368	460	506
	36"	1 1/4"	487	520	450	350	386	482	531
	48"	1 1/4"	639	692	542	440	483	605	666
	60"	1 1/4"	672	715	559	456	502	626	690
	72"	1 1/4"	702	737	599	472	519	650	713
RM3824	84"	1 1/4"	826	862	652	524	578	721	794
	96"	1 1/4"	951	986	705	577	633	793	871
	12"	1 1/2"	503	539	450	350	386	482	531
	24"	1 1/2"	556	591	471	371	408	510	561
	36"	1 1/2"	598	633	512	411	452	566	623
	48"	1 1/2"	675	694	599	472	519	650	713
	60"	1 1/2"	733	753	631	504	554	693	762
RM3844	72"	1 1/2"	791	810	663	535	589	736	810
	84"	1 1/2"	898	917	714	585	644	805	886
	96"	1 1/2"	1,005	1,023	765	636	700	875	962



Offset Pulls - Round Ends									
RM3834	12"	1"	441	476	436	336	369	462	508
	24"	1"	517	558	481	380	418	524	576
	36"	1"	602	651	526	424	467	583	641
	48"	1"	686	741	593	468	514	642	708
	60"	1"	735	794	615	489	539	673	741
	72"	1"	784	847	637	511	562	703	773
	84"	1"	883	953	678	551	606	758	834
RM3844	96"	1"	980	1,058	718	590	661	812	908
	12"	1 1/4"	460	496	441	341	383	469	526
	24"	1 1/4"	543	586	487	386	432	531	594
	36"	1 1/4"	615	665	532	431	482	593	663
	48"	1 1/4"	687	742	601	475	531	652	730
	60"	1 1/4"	720	777	616	490	549	674	755
	72"	1 1/4"	751	812	633	507	568	696	780
RM3854	84"	1 1/4"	876	946	687	559	626	769	862
	96"	1 1/4"	999	1,079	739	611	684	840	940
	12"	1 1/2"	546	590	489	388	436	534	599
	24"	1 1/2"	598	646	512	411	460	566	634
	36"	1 1/2"	661	715	585	459	514	632	708
	48"	1 1/2"	723	782	633	507	568	696	780
	60"	1 1/2"	782	845	666	539	603	741	829
RM3854	72"	1 1/2"	839	906	697	570	639	783	878
	84"	1 1/2"	947	1,022	750	621	695	854	956
	96"	1 1/2"	1,054	1,137	802	673	753	924	1,035

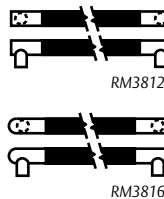

Push Bars - Flat Ends									
RM3802	Up to 36" CTC	1"	398	451	395	296	325	406	447
RM3812	Up to 36" CTC	1 1/4"	441	476	410	310	341	426	469
RM3822	Up to 36" CTC	1 1/2"	556	591	471	371	408	510	561
Push Bars - Round Ends									
RM3806	Up to 36" CTC	1"	441	494	436	336	369	462	508
RM3816	Up to 36" CTC	1 1/4"	487	520	450	350	386	482	531
RM3826	Up to 36" CTC	1 1/2"	598	633	512	411	452	566	623

• Add \$6.50/in. over 36".

NOTE: Post location on push bars can be located 1/8" from end for narrow & medium stile doors and 1" from end for flush and wide stile doors.

ASSA ABLOY

Opening Solutions

The global leader in door opening solutions

USA & Canada Prices Effective June 3, 2019

Copyright © 2019, ASSA ABLOY Accessories and Door Controls Group, Inc. All rights reserved. Reproduction in whole or in part without the express written permission of ASSA ABLOY Accessories and Door Controls Group, Inc. is prohibited.

NoirTek - Black Anodized Grip with Contrasting Posts

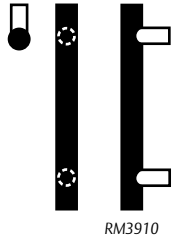

RM3910

Straight Pulls - Flat Ends									
Part	Max OA	Dia.	28/628	313/710 315/711	3/605 4/606	10/612 10B/613	Stock PC 10BE	32D/630	32/629
RM3900	12"	1"	177	196	232	250	232	171	192
	24"	1"	252	276	264	284	257	195	218
	36"	1"	326	358	277	299	272	210	235
	48"	1"	400	440	471	509	401	302	338
	60"	1"	474	522	522	563	423	323	362
	72"	1"	549	603	572	617	444	344	385
	84"	1"	622	684	672	725	474	373	417
RM3910	12"	1 1/4"	195	214	250	270	239	177	199
	24"	1 1/4"	273	301	304	328	272	210	235
	36"	1 1/4"	353	388	319	345	288	225	251
	48"	1 1/4"	432	475	472	510	417	317	355
	60"	1 1/4"	510	561	505	545	434	334	374
	72"	1 1/4"	589	648	538	581	449	349	391
	84"	1 1/4"	669	735	662	716	503	402	450
RM3920	12"	1 1/2"	231	254	339	366	288	225	251
	24"	1 1/2"	295	325	390	422	348	250	280
	36"	1 1/2"	360	395	435	470	384	285	319
	48"	1 1/2"	424	467	511	552	450	350	392
	60"	1 1/2"	489	537	570	615	484	383	428
	72"	1 1/2"	553	609	626	677	516	414	464
	84"	1 1/2"	617	679	735	794	592	467	522

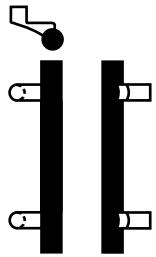







RM3940

Offset Pulls - Flat Ends									
RM3930	12"	1"			274	297	273	211	236
	24"	1"			306	331	333	235	263
	36"	1"			319	345	348	250	280
	48"	1"			513	554	441	341	382
	60"	1"			564	610	464	364	407
	72"	1"			614	663	485	384	430
	84"	1"			714	770	513	412	462
RM3940	12"	1 1/4"			293	316	280	217	244
	24"	1 1/4"			346	374	348	250	280
	36"	1 1/4"			362	390	363	265	297
	48"	1 1/4"			515	556	458	357	401
	60"	1 1/4"			547	591	475	374	418
	72"	1 1/4"			580	626	490	389	437
	84"	1 1/4"			706	761	544	442	495
RM3950	12"	1 1/2"			381	412	363	265	297
	24"	1 1/2"			434	468	389	289	324
	36"	1 1/2"			477	515	425	325	365
	48"	1 1/2"			553	597	491	390	438
	60"	1 1/2"			612	660	524	422	474
	72"	1 1/2"			668	722	557	454	508
	84"	1 1/2"			778	840	633	507	568

• Add \$6.50/in. over 36".

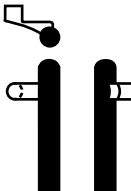
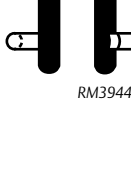
NOTE: Post location on push bars can be located 1/8" from end for narrow & medium stile doors and 1" from end for flush and wide stile doors.

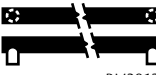
NoirTek - Black Anodized Grip with Contrasting Posts (con't)

Straight Pulls - Round Ends										
Part	Max OA	Dia.	28/628	313/710 315/711	3/605 4/606	10/612 10B/613	Stock PC 10BE	32D/630	32/629	
 RM3904	12"	1"	220	242	329	355	279	216	242	
	24"	1"	291	320	361	389	339	241	270	
	36"	1"	361	397	374	404	354	255	286	
	48"	1"	432	475	568	614	447	347	389	
	60"	1"	502	552	619	668	469	369	413	
	72"	1"	572	629	668	722	490	389	437	
 RM3914	12"	1 1/4"	237	261	347	375	287	224	250	
	24"	1 1/4"	306	336	401	433	354	255	286	
	36"	1 1/4"	376	413	416	449	370	271	303	
	48"	1 1/4"	445	490	570	615	464	364	407	
	60"	1 1/4"	514	565	602	650	480	379	424	
	72"	1 1/4"	584	642	634	686	497	396	443	
 RM3924	12"	1 1/2"	273	301	436	471	370	271	303	
	24"	1 1/2"	349	384	488	527	395	296	331	
	36"	1 1/2"	424	467	531	574	431	331	371	
	48"	1 1/2"	500	550	608	657	498	397	444	
	60"	1 1/2"	574	632	666	720	530	428	480	
	72"	1 1/2"	650	715	723	781	585	459	515	
 RM3934	12"	1"			372	401	355	256	287	
	24"	1"			403	435	380	281	314	
	36"	1"			416	449	395	296	331	
	48"	1"			611	659	488	387	434	
	60"	1"			661	715	510	409	458	
	72"	1"			711	768	531	430	481	
 RM3944	12"	1 1/4"			389	420	362	264	296	
	24"	1 1/4"			443	478	395	296	331	
	36"	1 1/4"			458	495	410	310	348	
	48"	1 1/4"			612	660	505	404	452	
	60"	1 1/4"			645	696	521	419	470	
	72"	1 1/4"			678	731	538	436	487	
 RM3954	12"	1 1/2"			478	516	410	310	348	
	24"	1 1/2"			530	573	436	336	376	
	36"	1 1/2"			574	620	471	371	416	
	48"	1 1/2"			651	702	539	437	489	
	60"	1 1/2"			709	765	594	469	525	
	72"	1 1/2"			766	827	626	500	559	
 RM3902	Up to 36" CTC	1"	326	358	277	299	272	210	235	
	 RM3912	Up to 36" CTC	1 1/4"	353	388	319	345	288	225	251
		Up to 36" CTC	1 1/2"	360	395	435	470	384	285	319
	 RM3916	Up to 36" CTC	1"	361	397	374	404	354	255	286
		Up to 36" CTC	1 1/4"	376	413	416	449	370	271	303
		Up to 36" CTC	1 1/2"	424	467	531	574	431	331	371
Up to 36" CTC		1 1/2"	424	467	531	574	431	331	371	

• Add \$6.50/in. over 36".

NOTE: Post location on push bars can be located 1/8" from end for narrow & medium stile doors and 1" from end for flush and wide stile doors.

ASSA ABLOY





Opening Solutions

The global leader in
door opening solutions

USA & Canada Prices Effective June 3, 2019

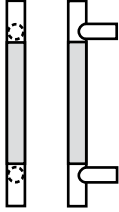
Copyright © 2019, ASSA ABLOY Accessories and Door Controls Group, Inc. All rights reserved. Reproduction in whole or in part without the express written permission of ASSA ABLOY Accessories and Door Controls Group, Inc. is prohibited.

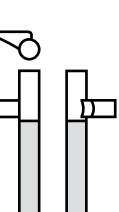
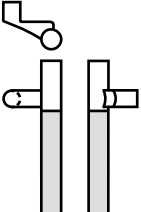
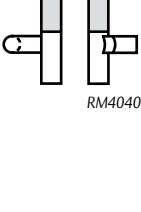
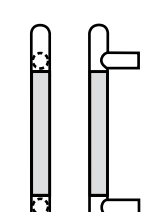
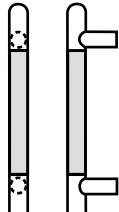
ArborMet - Wood Grip Pulls

Straight Pulls - Flat Ends							
Part	Max OA	Dia.	3/605 4/606	10/612 10B/613	Stock PC 10BE	32D/630	32/629
 RM4000	12"	1"	456	492	453	347	389
	24"	1"	515	556	510	403	450
	36"	1"	574	619	590	458	512
	48"	1"	632	683	648	513	575
 RM4010	12"	1 1/4"	476	514	466	361	404
	24"	1 1/4"	535	578	524	416	466
	36"	1 1/4"	593	641	604	471	527
	48"	1 1/4"	652	705	662	526	589
 RM4020	12"	1 1/2"	555	599	522	413	464
	24"	1 1/2"	614	662	602	469	525
	36"	1 1/2"	673	726	659	524	587
	48"	1 1/2"	731	790	716	579	648
Offset Pulls - Flat Ends							
 RM4030	12"	1"	497	537	492	386	432
	24"	1"	556	600	573	441	494
	36"	1"	615	664	630	496	556
	48"	1"	674	727	688	551	617
 RM4040	12"	1 1/4"	517	558	507	399	447
	24"	1 1/4"	576	622	587	455	509
	36"	1 1/4"	634	686	645	509	571
	48"	1 1/4"	693	749	701	565	632
 RM4050	12"	1 1/2"	596	644	585	452	506
	24"	1 1/2"	655	708	642	507	568
	36"	1 1/2"	714	770	699	563	630
	48"	1 1/2"	773	834	757	617	692
Straight Pulls - Round Ends							
 RM4004	12"	1"	550	594	499	392	438
	24"	1"	609	657	579	446	500
	36"	1"	667	721	636	502	562
	48"	1"	726	785	694	557	624
 RM4014	12"	1 1/4"	571	616	512	405	453
	24"	1 1/4"	629	679	592	460	515
	36"	1 1/4"	688	743	650	515	577
	48"	1 1/4"	747	806	708	570	638
 RM4024	12"	1 1/2"	649	700	590	458	512
	24"	1 1/2"	708	764	648	513	575
	36"	1 1/2"	766	828	705	568	636
	48"	1 1/2"	825	891	762	623	698

• Add on will apply for Premium and Super Premium wood species, as well as any additional wood finishing.

NOTE: Post location on push bars can be located 1/8" from end for narrow & medium stile doors and 1" from end for flush and wide stile doors.

ArborMet - Wood Grip Pulls (con't)

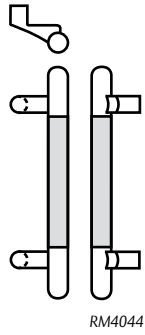

RM4044

Offset Pulls - Round Ends							
Part	Max OA	Dia.	3/605 4/606	10/612 10B/613	Stock PC 10BE	32D/630	32/629
RM4034	12"	1"	591	639	539	430	482
	24"	1"	650	702	620	485	543
	36"	1"	709	765	676	540	605
	48"	1"	767	829	734	596	667
RM4044	12"	1 1/4"	611	660	575	443	497
	24"	1 1/4"	671	724	633	498	559
	36"	1 1/4"	729	787	690	553	620
	48"	1 1/4"	788	851	748	609	682
RM4054	12"	1 1/2"	690	746	630	496	556
	24"	1 1/2"	749	809	688	551	617
	36"	1 1/2"	808	872	746	606	680
	48"	1 1/2"	866	935	802	662	741
Push Bars - Flat Ends							
RM4002	Up to 36" CTC	1"	574	619	590	458	512
RM4012	Up to 36" CTC	1 1/4"	593	641	604	471	527
RM4022	Up to 36" CTC	1 1/2"	673	726	659	524	587
Push Bars - Round Ends							
RM4006	Up to 36" CTC	1"	667	721	636	502	562
RM4016	Up to 36" CTC	1 1/4"	688	743	650	515	577
RM4026	Up to 36" CTC	1 1/2"	766	828	705	568	636

- Add on will apply for Premium and Super Premium wood species, as well as any additional wood finishing.

NOTE: Post location on push bars can be located 1/8" from end for narrow & medium stile doors and 1" from end for flush and wide stile doors.

ArborMet - Wood Grip Pulls (con't)

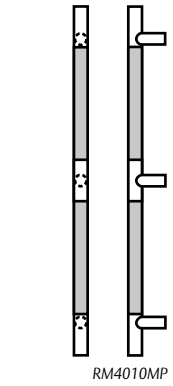

Straight Pulls - Flat Ends							
Part	Max OA	Dia.	3/605 4/606	10/612 10B/613	Stock PC 10BE	32D/630	32/629
RM4000MP	60"	1"	735	794	753	614	688
	72"	1"	794	858	811	670	750
	84"	1"	853	921	868	725	812
	96"	1"	912	985	926	781	875
RM4010MP	60"	1 1/4"	755	816	767	627	702
	72"	1 1/4"	814	880	824	683	765
	84"	1 1/4"	872	942	882	738	826
	96"	1 1/4"	931	1,006	940	794	889
RM4020MP	60"	1 1/2"	834	901	821	680	762
	72"	1 1/2"	893	964	879	735	824
	84"	1 1/2"	952	1,028	937	791	886
	96"	1 1/2"	1,010	1,091	994	846	948

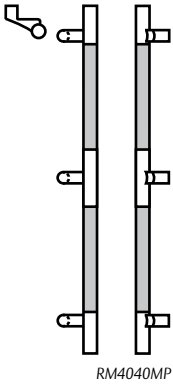

Offset Pulls - Flat Ends							
RM4030MP	60"	1"	777	838	793	652	730
	72"	1"	835	902	851	708	793
	84"	1"	894	965	908	764	855
	96"	1"	953	1,029	966	819	917
RM4040MP	60"	1 1/4"	796	860	806	666	745
	72"	1 1/4"	855	924	864	721	808
	84"	1 1/4"	914	987	922	777	870
	96"	1 1/4"	972	1,051	980	832	932
RM4050MP	60"	1 1/2"	876	946	862	718	805
	72"	1 1/2"	934	1,008	920	774	867
	84"	1 1/2"	993	1,072	978	829	929
	96"	1 1/2"	1,052	1,135	1,035	885	992

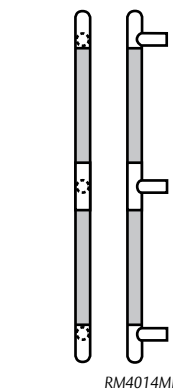

Straight Pulls - Round Ends							
RM4004MP	60"	1"	829	896	799	658	737
	72"	1"	888	959	857	713	799
	84"	1"	947	1,023	915	769	862
	96"	1"	1,005	1,086	972	824	923
RM4014MP	60"	1 1/4"	850	918	813	671	751
	72"	1 1/4"	908	981	870	726	814
	84"	1 1/4"	967	1,044	928	782	876
	96"	1 1/4"	1,026	1,107	986	837	938
RM4024MP	60"	1 1/2"	928	1,002	867	724	811
	72"	1 1/2"	987	1,066	925	780	873
	84"	1 1/2"	1,045	1,129	983	835	935
	96"	1 1/2"	1,104	1,193	1,041	891	998

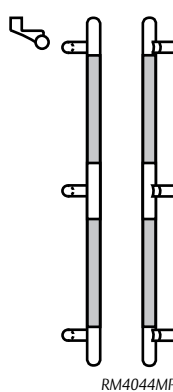

Offset Pulls - Round Ends							
RM4034MP	60"	1"	870	940	839	697	780
	72"	1"	929	1,003	897	752	842
	84"	1"	988	1,067	954	853	955
	96"	1"	1,046	1,131	1,012	954	1,069
RM4044MP	60"	1 1/4"	891	962	853	710	794
	72"	1 1/4"	950	1,025	910	766	857
	84"	1 1/4"	1,008	1,089	968	821	919
	96"	1 1/4"	1,067	1,152	1,026	877	982
RM4054MP	60"	1 1/2"	969	1,046	907	763	854
	72"	1 1/2"	1,028	1,110	965	818	916
	84"	1 1/2"	1,087	1,174	1,023	874	979
	96"	1 1/2"	1,145	1,237	1,080	929	1,040

• Add on will apply for Premium and Super Premium wood species, as well as any additional wood finishing.

NOTE: Post location on push bars can be located 1/8" from end for narrow & medium stile doors and 1" from end for flush and wide stile doors.

ArborTek - Wood Grip Pulls

Straight Pulls - Flat Ends							
Part	Max OA	Dia.	3/605 4/606	10/612 10B/613	Stock PC 10BE	32D/630	32/629
RM4100	12"	1"	339	366	338	237	266
	24"	1"	398	430	396	292	327
	36"	1"	456	492	453	347	389
	48"	1"	515	556	510	403	450
RM4110	12"	1 ¼"	358	387	362	261	292
	24"	1 ¼"	417	451	420	315	354
	36"	1 ¼"	476	514	477	371	415
	48"	1 ¼"	535	578	534	425	477
RM4120	12"	1 ½"	438	473	407	303	339
	24"	1 ½"	496	536	464	359	401
	36"	1 ½"	555	599	522	413	464
	48"	1 ½"	614	662	602	469	525
Offset Pulls - Flat Ends							
RM4130	12"	1"	380	410	378	276	309
	24"	1"	439	474	436	331	371
	36"	1"	497	537	492	386	432
	48"	1"	556	600	573	441	494
RM4140	12"	1 ¼"	400	432	402	299	334
	24"	1 ¼"	458	495	460	354	397
	36"	1 ¼"	517	558	517	409	459
	48"	1 ¼"	576	622	597	465	520
RM4150	12"	1 ½"	478	517	447	341	383
	24"	1 ½"	538	580	504	397	444
	36"	1 ½"	596	644	585	452	506
	48"	1 ½"	655	708	642	507	568
Straight Pulls - Round Ends							
RM4104	12"	1"	433	468	384	281	315
	24"	1"	491	530	441	336	377
	36"	1"	550	594	499	392	438
	48"	1"	609	657	579	446	500
RM4114	12"	1 ¼"	452	489	408	304	340
	24"	1 ¼"	511	552	465	360	403
	36"	1 ¼"	571	616	523	415	465
	48"	1 ¼"	629	679	603	470	526
RM4124	12"	1 ½"	531	574	453	347	389
	24"	1 ½"	590	638	510	403	450
	36"	1 ½"	649	700	590	458	512
	48"	1 ½"	708	764	648	513	575

• Add on will apply for Premium and Super Premium wood species, as well as any additional wood finishing.

NOTE: Post location on push bars can be located 1/8" from end for narrow & medium stile doors and 1" from end for flush and wide stile doors.

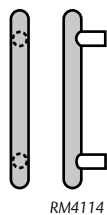
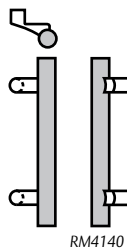
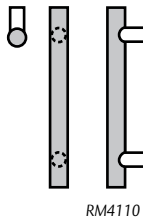

ArborTek - Wood Grip Pulls (con't)

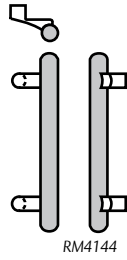

Offset Pulls - Round Ends							
Part	OA	Dia.	3/605 4/606	10/612 10B/613	Stock PC 10BE	32D/630	32/629
RM4134	12"	1"	474	512	424	320	359
	24"	1"	533	575	482	375	420
	36"	1"	591	639	539	430	482
	48"	1"	650	702	620	485	543
RM4144	12"	1 1/4"	493	534	448	343	384
	24"	1 1/4"	552	596	505	398	445
	36"	1 1/4"	611	660	586	453	508
	48"	1 1/4"	671	724	643	508	570
RM4154	12"	1 1/2"	573	618	492	386	432
	24"	1 1/2"	631	682	573	441	494
	36"	1 1/2"	690	746	630	496	556
	48"	1 1/2"	749	809	688	551	617

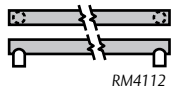

Push Bars - Flat Ends							
RM4112	Up to 36" CTC	1 1/4"	476	514	477	371	415
RM4122	Up to 36" CTC	1 1/2"	555	599	522	413	464

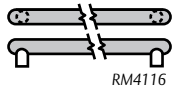

Push Bars - Round Ends							
RM4116	Up to 36" CTC	1 1/4"	571	616	523	415	465
RM4126	Up to 36" CTC	1 1/2"	649	700	590	458	512

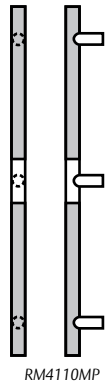

Straight Pulls - Flat Ends							
Part	Max OA	Dia.	3/605 4/606	10/612 10B/613	Stock PC 10BE	32D/630	32/629
RM4100MP	60"	1"	618	667	615	504	564
	72"	1"	677	730	673	560	626
	84"	1"	735	794	731	615	689
	96"	1"	794	858	789	671	750
RM4110MP	60"	1 1/4"	638	689	639	526	590
	72"	1 1/4"	696	752	697	582	652
	84"	1 1/4"	755	816	755	637	714
	96"	1 1/4"	814	879	813	693	777
RM4120MP	60"	1 1/2"	717	774	707	570	638
	72"	1 1/2"	776	837	764	625	700
	84"	1 1/2"	834	901	822	681	763
	96"	1 1/2"	893	964	880	736	824

- Add on will apply for Premium and Super Premium wood species, as well as any additional wood finishing.

NOTE: Post location on push bars can be located 1/8" from end for narrow & medium stile doors and 1" from end for flush and wide stile doors.

ArborTek - Wood Grip Pulls (con't)

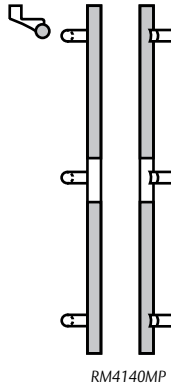

RM4140MP

Offset Pulls - Flat Ends							
Part	Max OA	Dia.	3/605 4/606	10/612 10B/613	Stock PC 10BE	32D/630	32/629
RM4130MP	60"	1"	659	712	678	542	607
	72"	1"	718	776	736	598	670
	84"	1"	777	838	794	653	731
	96"	1"	835	902	852	709	794
RM4140MP	60"	1 ¼"	679	939	702	566	633
	72"	1 ¼"	737	797	760	621	695
	84"	1 ¼"	796	860	818	677	758
	96"	1 ¼"	855	924	876	732	820
RM4150MP	60"	1 ½"	758	819	747	608	681
	72"	1 ½"	817	882	804	664	743
	84"	1 ½"	876	946	862	719	806
	96"	1 ½"	934	1,008	920	775	868

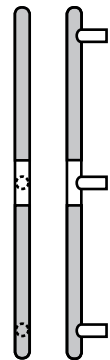

RM4114MP

Straight Pulls - Round Ends							
RM4104MP	60"	1"	712	768	684	547	613
	72"	1"	770	832	741	603	676
	84"	1"	829	896	799	659	737
	96"	1"	888	959	857	714	800
RM4114MP	60"	1 ¼"	732	790	708	571	639
	72"	1 ¼"	791	854	765	626	702
	84"	1 ¼"	850	918	823	682	764
	96"	1 ¼"	908	981	881	737	826
RM4124MP	60"	1 ½"	811	876	753	614	688
	72"	1 ½"	869	939	811	670	749
	84"	1 ½"	928	1,002	868	725	812
	96"	1 ½"	987	1,066	926	781	874

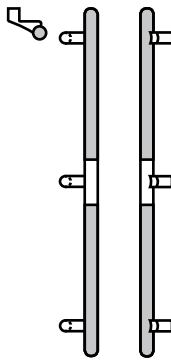

RM4144MP

Offset Pulls - Round Ends							
RM4134MP	60"	1"	753	814	725	586	657
	72"	1"	812	877	782	641	719
	84"	1"	870	940	840	697	781
	96"	1"	929	1,003	898	752	843
RM4144MP	60"	1 ¼"	774	835	748	609	683
	72"	1 ¼"	832	898	805	665	744
	84"	1 ¼"	891	962	863	720	807
	96"	1 ¼"	950	1,025	921	776	870
RM4154MP	60"	1 ½"	852	920	793	652	730
	72"	1 ½"	911	984	851	708	793
	84"	1 ½"	969	1,046	908	764	855
	96"	1 ½"	1,028	1,110	966	819	917

• Add on will apply for Premium and Super Premium wood species, as well as any additional wood finishing.

NOTE: Post location on push bars can be located 1/8" from end for narrow & medium stile doors and 1" from end for flush and wide stile doors.

ArborTek - Wood Grip Pulls (con't)

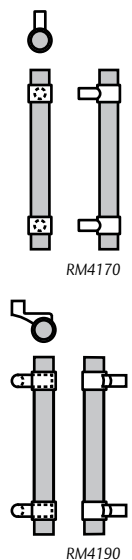

Wood Pulls with Collar Mount Posts							
Straight Pulls - Flat Ends							
Part	Max OA	Dia.	3/605 4/606	10/612 10B/613	Stock PC 10BE	32D/630	32/629
RM4160	12"	1"	497	538	520	411	461
	24"	1"	575	621	595	484	542
	36"	1"	651	702	670	556	622
	48"	1"	731	790	748	631	707
RM4170	12"	1 1/4"	506	546	527	419	470
	24"	1 1/4"	598	647	617	506	567
	36"	1 1/4"	690	746	708	592	663
	48"	1 1/4"	756	816	772	653	732
Offset Pulls - Flat Ends							
RM4180	12"	1"	551	596	572	462	517
	24"	1"	636	686	654	541	606
	36"	1"	721	779	737	621	696
	48"	1"	779	840	794	675	755
RM4190	12"	1 1/4"	557	602	578	468	524
	24"	1 1/4"	657	710	675	562	628
	36"	1 1/4"	757	818	773	655	733
	48"	1 1/4"	796	859	811	692	774

- Add on will apply for Premium and Super Premium wood species, as well as any additional wood finishing.

NOTE: Post location on push bars can be located 1/8" from end for narrow & medium stile doors and 1" from end for flush and wide stile doors.

Wood Species	
Domestic (Standard)	Hickory, White Oak, Red Oak, Maple
Premium	Beech, Cherry, Birch
Super Premium	Mahogany, Jatoba (Brazilian Cherry), Canary, Walnut

Wood Add On

Wood Species	Wood Dia	Add On	Wood Species	Wood Dia	Add On	Finish	Add On
Premium	1"	24	Super Premium	1"	60	Clear	200
	1 1/4"	40		1 1/4"	80	Dyed	200
	1 1/2"	60		1 1/2"	100	Tung Oil	65

- Wood is a natural material, colors and grain will vary between pulls.
- Other wood species are available by request.
- Hickory, sanded unfinished is the stock species; other wood types will require longer lead times and may be subject to availability,



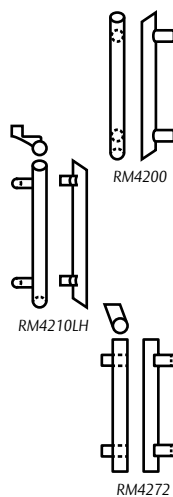



SkewTek - Angled End Pulls

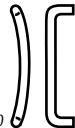
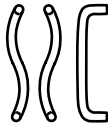
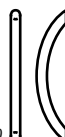
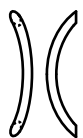

Straight Pull - Forward Segment									
Part	Max OA	Dia.	28/628	313/710 315/711	3/605 4/606	10/612 10B/613	Stock PC 10BE	32D/630	32/629
RM4200-11	16"	1 1/2"	493	542	640	690	544	443	497
Offset Pulls - Forward Segment									
RM4210LH-11	16"	1 1/2"	528	581	680	733	601	477	535
RM4210RH-11	16"	1 1/2"	528	581	680	733	601	477	535
Straight Pulls - Rectangular Posts									
RM4270-12	18"	2"	703	752	1,065	1,151	826	698	782
RM4270-24	30"	2"	769	821	1,164	1,257	908	779	872
Offset Pulls - Rectangular Posts									
RM4272-12	18"	2"	869	920	1,230	1,329	963	832	931
RM4272-24	30"	2"	937	986	1,327	1,433	1,069	914	1,022
Straight Pulls - Round Posts									
RM4274-12	18"	2"	703	752	1,065	1,151	826	698	782
RM4274-24	30"	2"	769	821	1,164	1,257	908	779	872

- Add \$6.50/in. over 30".

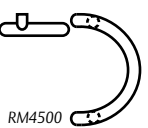
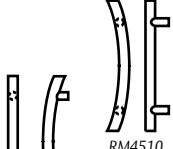
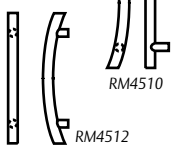
CenTrex - Shaped Pulls

Curved Pulls										
Part	CTC	28/628	313/710 315/711	3/605 4/606	10/612 10B/613	Stock PC 10BE	26/625 26D/626	32D/630	32/629	
 RM4400	RM4400-12	12"	369	389	557	603	464	557	360	402
	RM4400-20	20"	385	405	618	667	479	618	374	419
Double Curved Pulls										
 RM4402LH	RM4402LH	12"	442	461	618	667	513	618	406	456
	RM4402RH	12"	442	461	618	667	513	618	406	456
Straight Radius Pulls										
 RM4410	RM4410-12	12"	327	346	557	603	413	557	309	346
	RM4410-18	18"	346	366	618	667	431	618	326	366
	RM4410-24	24"	366	385	675	728	464	675	360	402
Offset Radius Pulls										
 RM4412	RM4412-12	12"	405	423	638	688	479	638	374	419
	RM4412-18	18"	423	442	692	748	498	692	391	439
	RM4412-24	24"	442	461	751	811	530	751	423	474
Semi-Circular Pulls										
 RM4422	RM4420	9"	252	270		501	347	464	245	274
	RM4422	12"	270	290		520	364	482	264	294
Radius Push Bars										
 RM4440LH	RM4440LH	Up to 36"	480	500	848	916	707	848	571	638
	RM4440RH	Up to 36"	480	500	848	916	707	848	571	638
Compound Radius Push Bars										
 RM4450LH	RM4450LH	Up to 36"	956	1,015	622	1,310	1,065	1,213	894	1,002
	RM4450RH	Up to 36"	956	1,015	622	1,310	1,065	1,213	894	1,002
Semi-Circular Pulls										
 RM4500	RM4500	11"	385	405	771	832	569		438	490
	RM4502	11"	385	405	771	832	569		438	490
	RM4506	12"			502	543	446		342	383
Side Radius Pull										
 RM4510	RM4510	12"	423	461	578	624	513		406	456
Projecting Radius Pull										
 RM4512	RM4512	12"			848	916	654		520	582
Radius Push Bars										
 RM4516LH	RM4516LH	Up to 36"	518	556	751	811	603		471	527
	RM4516RH	Up to 36"	518	556	751	811	603		471	527

NOTE: Post location on push bars can be located $\frac{1}{8}$ " from end for narrow & medium stile doors and 1" from end for flush and wide stile doors.

ASSA ABLOY

Opening Solutions

The global leader in
door opening solutions

USA & Canada Prices Effective June 3, 2019

Copyright © 2019, ASSA ABLOY Accessories and Door Controls Group, Inc. All rights reserved. Reproduction in whole or in part without the express written permission of ASSA ABLOY Accessories and Door Controls Group, Inc. is prohibited.

AccenTek™ - Solid Pulls with Accents

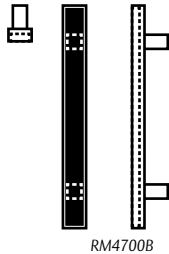

RM4700B

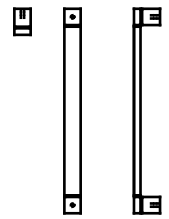

RM4750

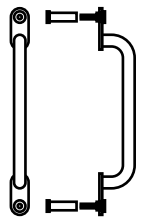

RM4800

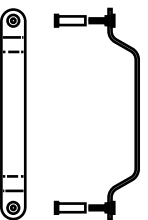

RM4820

Cast Pulls									
Part	Grip	CTC	Stock PC 10BE	3/605 4/606	10/612 10A/722	10B/613 10BL/614	15/619 15A/620	20A/624	26/625 26D/626
RM4720	1 1/2" x 1/2" x 12 1/2"	8"	463	439	475	475	475	475	475
RM4700W	1 1/4" x 5/8" x 14"	10"	538	511	551	551	551	551	551
RM4700B	1 1/4" x 5/8" x 14"	10"	538	511	551	551	551	551	551
Solid Groove Pulls									
Part	Grip	CTC	32D/630	32/629					
RM4750	1/2" x 1 1/4"	12"	327	368					
	1/2" x 1 1/4"	24"	380	424					
	1/2" x 1 1/4"	36"	431	483					
	1/2" x 1 1/4"	48"	482	539					
RM4755	3/4" x 1 1/4"	12"	372	416					
	3/4" x 1 1/4"	24"	423	474					
	3/4" x 1 1/4"	36"	476	532					
	3/4" x 1 1/4"	48"	526	589					
Formed Pulls with Distinguished Fastener Heads									
Part	Grip	CTC	Wrought Black	Stock PC 10BE	Black Suede	32D/630	Industrial Steel		
RM4800	3/4" Dia	12"	390	390	390	347			
		16"	390	390	390	347	420		
		24"	479	479	479	427			
		36"	589	589	589	526			
RM4810	1 1/2" x 1/4"	12"	321	321	321	281			
		16"	321	321	321	281	346		
		24"	395	395	395	346			
		36"	486	486	486	425			
RM4820	1 1/2" x 3/16"	12"	390	390	390	347			
		16"	390	390	390	347	420		
		24"	479	479	479	427			
		36"	589	589	589	526			
RM4800 x RM4810		12"	711	711	711	628			
		16"	711	711	711	628	766		
		24"	875	875	875	773			
		36"	1,075	1,075	1,075	950			
RM4820 x RM4810		12"	711	711	711	628			
		16"	711	711	711	628	766		
		24"	875	875	875	773			
		36"	1,075	1,075	1,075	950			

- RM4700 pulls contain white or black polycarbonate insert.
- RM4750 & RM4755 pulls add \$9.70/in. over 48". CTC up to 60".
- RM4800 series, US32D and US10BE come with Socket Head Screws. Other finishes come with Hex Head Screws.
- RM4800 series longer lengths may be offered, call factory for pricing.
- Specify CTC when ordering.

PlanTek - Flat Front Pulls



RM5200

Straight Cast Pulls								
Part	CTC	Grip Size	3/605 4/606	10/612 10B/613	Stock PC 10BE	26/625 26D/626	32D/630	32/629
RM5200-7	7"	1"	270	291	278	270		
RM5200-12	12"	1"	311	336	321	311		
RM5202	12"	1 1/4"	393	424	405	393		

Offset Cast Pulls								
RM5204-8	8"	1"	270	291	278	270		
RM5204-12	12"	1"	311	336	321	311		



RM5210

Radius End Pulls								
RM5210-10	10"	1/2" x 1 1/4"	553	597	433		327	368
RM5210-12	12"	1/2" x 1 1/4"	575	621	449		344	385
RM5220-12	12"	3/4" x 1 1/2"	738	797	482		375	420
RM5220-18	18"	3/4" x 1 1/2"	822	888	533		424	476



RM5250

Square End Pulls								
RM5230-10	10"	1/2" x 1 1/4"	512	553	349		247	277
RM5230-12	12"	1/2" x 1 1/4"	536	579	364		263	293
RM5240-12	12"	3/4" x 1 1/2"	678	733	382		279	312
RM5240-18	18"	3/4" x 1 1/2"	758	820	398		295	331

Bent End Pulls								
RM5250-10	10"	1/2" x 1 1/4"	414	446	332		230	258
RM5250-12	12"	1/2" x 1 1/4"	432	466	349		247	277
RM5260-12	12"	3/4" x 1 1/2"	553	597	398		295	331
RM5260-18	18"	3/4" x 1 1/2"	656	708	433		327	368

Radius End Pulls								
RM5270-10	10"	1/2" x 3/4"			416		312	349
RM5270-12	12"	1/2" x 3/4"			428		324	364
RM5270-16	16"	1/2" x 3/4"			460		354	397



RM5270

Straight Cast Pull								
RM5280	9"	1/2" x 1/2"	126	135	129	126		
Push Bars - Radius Ends								
RM5212	Up to 36"	1/2" x 1 1/4"	758	820	515		407	457
RM5222	Up to 36"	3/4" x 1 1/2"	1,147	1,239	709		572	639
Push Bars - Flat Ends								
RM5232	Up to 36"	1/2" x 1 1/4"	758	820	449		344	385
RM5242	Up to 36"	3/4" x 1 1/2"	1,128	1,219	533		424	476

- Add \$9.70/in. over 36".
- RM5200, RM5202, RM5204 CTC can not be modified.

NOTE: Post location on push bars can be located 1/8" from end for narrow & medium stile doors and 1" from end for flush and wide stile doors.

Traditional - Decorative Pulls & Plates

Add pull price to plate price to make pull plate combination.

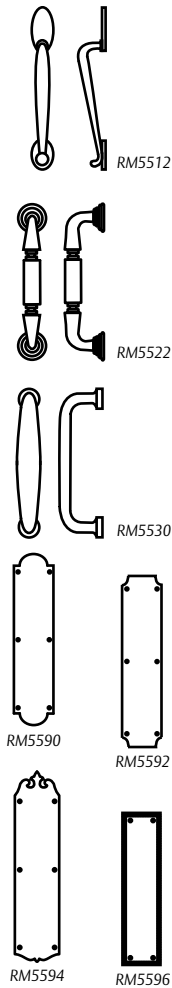

Cast Pulls							
Part	CTC	Base Plate	3/605 4/606	10/612 10B/613	Stock PC 10BE	15/619 15A/620	26/625 26D/626
RM5500	6"	no	105	112	106	118	105
RM5502	6 7/8"	yes	171	183	173	195	188
RM5510	12"	no	171	183	173	219	204
RM5512	12 7/8"	yes	238	258	244	302	272
Cast Pulls							
RM5520	8"	no	153	166	156	169	153
RM5522	8"	yes	188	202	190	202	188
Cast Pulls							
Part	Size		3/605 4/606	10/612 10B/613	Stock PC 10BE	15/619 15A/620	26/625 26D/626
RM5530	5 1/2"		54	58	55	65	54
RM5532	7 1/2"		78	84	80	89	83
RM5534	12"		231	249	235	244	231
Heavy Decorative Plates - .090" Thick							
RM5590A	3" x 12"		90	99	93	109	100
RM5590B	3 1/2" x 15"		100	108	102	116	110
RM5590C	4" x 16"		110	119	112	126	117
Heavy Decorative Plates - .090" Thick							
RM5592A	3" x 12"		90	99	93	109	
RM5592B	3 1/2" x 15"		100	108	102	116	
RM5592C	4" x 16"		110	119	112	126	
Heavy Decorative Plates - .090" Thick							
RM5594B	3 1/2" x 15"		181	195	185	196	188
Rope Border Cast Plates							
RM5596A	3" x 12"		110	119	112	116	110
RM5596B	3 1/2" x 15"		127	138	129	133	127
Plain Cast Plate - 5/16" Thick							
RM5598B	3 1/2" x 15"		145	155	147	150	145

Classic - Finial Door Pulls

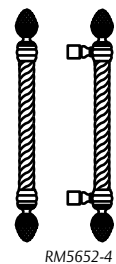

1" Door Pulls								
Part	CTC	Grip	Base Plate	3/605 4/606	10/612 10B/613	Stock PC 10BE	15/619 15A/620	26/625 26D/626
RM5650	10"	Plain	no	368	398	387	433	406
RM5652	10"	Rope	no	368	398	387	433	406
RM5654	10"	Fluted	no	368	398	387	433	406
RM5660	10"	Plain	yes	411	443	433	477	449
RM5662	10"	Rope	yes	411	443	433	477	449
RM5664	10"	Fluted	yes	411	443	433	477	449
1" Offset Door Pull								
RM5670	10"	Plain	no	415	449	438	460	452

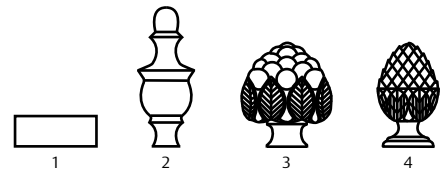

Finial Style Number (example: RM5650-4)

Suffix	Finial Style:
1	Plain
2	Urn
3	Berry
4	Pinecone

- To order suffix finial style number.
- Add \$6.50/in. for longer pulls up to 36".

MariTek - Tapered Pulls

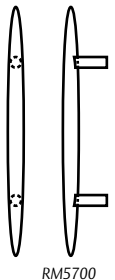

Straight Door Pulls						
Part	CTC	3/605 4/606	10B/613	Stock PC 10BE	14/618 15/619	26/625 26D/626
RM5700	6"	272	291	286	278	288
RM5702	12"	288	310	302	295	303

English Bridle Leather Pulls

Straight Pulls - Flat Ends							
Part	Max OA	Dia.	3/605 4/606	10/612 10B/613	Stock PC 10BE	32D/630	32/629
RM6060	12"	1"	732	791	658	555	622
	24"	1"	1,085	1,172	961	837	938
	36"	1"	1,438	1,552	1,243	1,120	1,254
	48"	1"	1,790	1,933	1,527	1,404	1,573
	60"	1"	2,157	2,329	1,812	1,688	1,891
	72"	1"	2,522	2,724	2,096	1,972	2,209
	84"	1"	2,726	2,944	2,204	2,081	2,330
	96"	1"	2,929	3,164	2,313	2,190	2,452
RM6061	12"	1 1/4"	816	881	746	643	720
	24"	1 1/4"	1,328	1,434	1,168	1,044	1,170
	36"	1 1/4"	1,840	1,987	1,570	1,446	1,619
	48"	1 1/4"	2,262	2,443	1,920	1,796	2,012
	60"	1 1/4"	2,684	2,898	2,270	2,147	2,404
	72"	1 1/4"	2,820	3,046	2,402	2,278	2,551
	84"	1 1/4"	2,955	3,192	2,533	2,409	2,699
	96"	1 1/4"	3,091	3,338	2,643	2,519	2,822
RM6062	12"	1 1/2"	929	1,003	838	735	824
	24"	1 1/2"	1,482	1,601	1,295	1,171	1,311
	36"	1 1/2"	2,034	2,197	1,730	1,607	1,799
	48"	1 1/2"	2,482	2,680	1,934	1,811	2,028
	60"	1 1/2"	2,929	3,164	2,138	2,015	2,257
	72"	1 1/2"	3,092	3,340	2,343	2,220	2,485
	84"	1 1/2"	3,256	3,516	2,547	2,424	2,714
	96"	1 1/2"	3,419	3,693	2,751	2,628	2,943
Offset Pulls - Flat Ends							
RM6070	12"	1"	768	830	689	586	656
	24"	1"	1,121	1,210	992	868	972
	36"	1"	1,474	1,591	1,274	1,151	1,289
	48"	1"	1,826	1,972	1,558	1,435	1,607
	60"	1"	2,193	2,368	1,843	1,719	1,925
	72"	1"	2,559	2,763	2,127	2,003	2,243
	84"	1"	2,762	2,983	2,235	2,112	2,365
	96"	1"	2,965	3,202	2,344	2,221	2,487
RM6071	12"	1 1/4"	852	920	777	674	754
	24"	1 1/4"	1,364	1,473	1,199	1,075	1,204
	36"	1 1/4"	1,876	2,026	1,601	1,477	1,654
	48"	1 1/4"	2,298	2,481	1,951	1,827	2,047
	60"	1 1/4"	2,720	2,938	2,301	2,177	2,439
	72"	1 1/4"	2,856	3,084	2,433	2,309	2,585
	84"	1 1/4"	2,991	3,231	2,564	2,440	2,733
	96"	1 1/4"	3,127	3,377	2,674	2,550	2,856
RM6072	12"	1 1/2"	965	1,042	869	766	858
	24"	1 1/2"	1,518	1,639	1,326	1,202	1,346
	36"	1 1/2"	2,070	2,236	1,761	1,638	1,834
	48"	1 1/2"	2,518	2,719	1,965	1,842	2,063
	60"	1 1/2"	2,965	3,202	2,169	2,046	2,292
	72"	1 1/2"	3,128	3,378	2,374	2,251	2,520
	84"	1 1/2"	3,292	3,555	2,578	2,454	2,749
	96"	1 1/2"	3,455	3,731	2,782	2,658	2,978

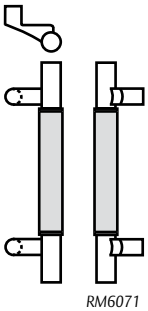
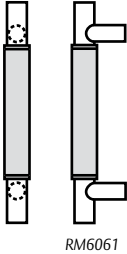

- Add \$6.50/in. over 96".
- MP (Mid Post) - Add \$76 each. (Recommended for maximum rigidity on long door pulls. See page 5 for guidelines.)
- FW (Full Wrap) available up to 72" overall length pull - Call for pricing.
- Specify leather color.

NOTE: All long pulls include charge for leather between mounting posts up to a maximum of 72" of leather cover.

English Bridle Leather Pulls (con't)

Straight Pulls - Round Ends							
Part	Max OA	Dia.	3/605 4/606	10/612 10B/613	Stock PC 10BE	32D/630	32/629
RM6080	12"	1"	811	876	694	591	662
	24"	1"	1,085	1,172	997	873	979
	36"	1"	1,438	1,552	1,279	1,156	1,295
	48"	1"	1,790	1,933	1,564	1,440	1,613
	60"	1"	2,157	2,329	1,848	1,724	1,931
	72"	1"	2,522	2,724	2,132	2,009	2,250
	84"	1"	2,726	2,944	2,240	2,117	2,371
	96"	1"	2,929	3,164	2,349	2,226	2,493
	RM6081	12"	1 1/4"	816	881	782	679
24"		1 1/4"	1,328	1,434	1,204	1,080	1,210
36"		1 1/4"	1,840	1,987	1,606	1,482	1,660
48"		1 1/4"	2,262	2,443	1,956	1,832	2,052
60"		1 1/4"	2,684	2,898	2,306	2,183	2,444
72"		1 1/4"	2,820	3,046	2,438	2,314	2,591
84"		1 1/4"	2,955	3,192	2,569	2,445	2,739
96"		1 1/4"	3,091	3,338	2,679	2,555	2,862
RM6082		12"	1 1/2"	929	1,003	874	771
	24"	1 1/2"	1,482	1,601	1,331	1,207	1,352
	36"	1 1/2"	2,034	2,197	1,766	1,643	1,840
	48"	1 1/2"	2,482	2,680	1,970	1,847	2,068
	60"	1 1/2"	2,929	3,164	2,174	2,051	2,297
	72"	1 1/2"	3,092	3,340	2,379	2,256	2,526
	84"	1 1/2"	3,256	3,516	2,583	2,460	2,754
	96"	1 1/2"	3,419	3,693	2,787	2,664	2,983
	Offset Pulls - Round Ends						
RM6090	12"	1"	846	914	725	622	696
	24"	1"	1,198	1,294	1,028	904	1,012
	36"	1"	1,551	1,675	1,310	1,187	1,329
	48"	1"	1,903	2,056	1,594	1,471	1,647
	60"	1"	2,270	2,451	1,879	1,755	1,965
	72"	1"	2,636	2,847	2,163	2,039	2,285
	84"	1"	2,840	3,066	2,271	2,148	2,405
	96"	1"	3,043	3,286	2,380	2,257	2,528
	RM6091	12"	1 1/4"	929	1,003	813	710
24"		1 1/4"	1,441	1,556	1,235	1,111	1,244
36"		1 1/4"	1,953	2,109	1,637	1,513	1,694
48"		1 1/4"	2,375	2,565	1,987	1,863	2,087
60"		1 1/4"	2,797	3,021	2,337	2,213	2,479
72"		1 1/4"	2,933	3,167	2,469	2,345	2,627
84"		1 1/4"	3,068	3,315	2,600	2,476	2,773
96"		1 1/4"	3,204	3,461	2,710	2,586	2,896
RM6092		12"	1 1/2"	1,042	1,126	905	802
	24"	1 1/2"	1,595	1,722	1,362	1,238	1,386
	36"	1 1/2"	2,148	2,320	1,797	1,674	1,875
	48"	1 1/2"	2,596	2,803	2,001	1,878	2,103
	60"	1 1/2"	3,043	3,286	2,205	2,082	2,332
	72"	1 1/2"	3,205	3,462	2,410	2,287	2,561
	84"	1 1/2"	3,369	3,638	2,614	2,491	2,789
	96"	1 1/2"	3,532	3,814	2,818	2,694	3,018

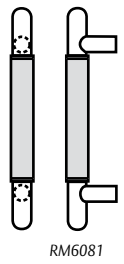

RM6081

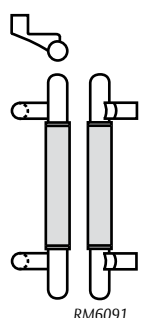

RM6091

- Add \$6.50/in. over 96".
- MP (Mid Post) - Add \$76 each. (Recommended for maximum rigidity on long door pulls. See page 5 for guidelines.)
- FW (Full Wrap) available up to 72" overall length pull - Call for pricing.
- Specify leather color.

NOTE: All long pulls include charge for leather between mounting posts up to a maximum of 72" of leather cover.

ASSA ABLOY
 Opening Solutions
 The global leader in
 door opening solutions

Upholstery Leather Pulls

Straight Pulls - Flat Ends							
Part	Max OA	Dia.	3/605 4/606	10/612 10B/613	Stock PC 10BE	32D/ 630	32/ 629
RM6160	12"	1"	687	743	616	510	572
	24"	1"	973	1,051	804	698	782
	36"	1"	1,345	1,453	1,116	989	1,108
	48"	1"	1,716	1,853	1,409	1,282	1,435
	60"	1"	1,983	2,142	1,579	1,451	1,625
	72"	1"	2,369	2,559	1,871	1,744	1,953
	84"	1"	2,531	2,733	1,970	1,843	2,063
	96"	1"	2,744	2,964	2,083	1,955	2,190
RM6161	12"	1 1/4"	772	834	678	572	641
	24"	1 1/4"	1,347	1,455	1,159	1,031	1,155
	36"	1 1/4"	1,887	2,038	1,572	1,445	1,618
	48"	1 1/4"	2,332	2,519	1,933	1,806	2,022
	60"	1 1/4"	2,659	2,871	2,202	2,075	2,324
	72"	1 1/4"	2,802	3,026	2,338	2,211	2,476
	84"	1 1/4"	2,944	3,180	2,442	2,315	2,593
	96"	1 1/4"	3,088	3,335	2,556	2,428	2,720
RM6162	12"	1 1/2"	877	948	724	617	692
	24"	1 1/2"	1,460	1,577	1,296	1,169	1,309
	36"	1 1/2"	2,042	2,205	1,745	1,618	1,812
	48"	1 1/2"	2,514	2,715	1,955	1,828	2,048
	60"	1 1/2"	2,985	3,224	2,165	2,038	2,283
	72"	1 1/2"	3,157	3,410	2,376	2,249	2,519
	84"	1 1/2"	3,330	3,596	2,586	2,459	2,754
	96"	1 1/2"	3,501	3,781	2,797	2,669	2,990
Offset Pulls - Flat Ends							
RM6170	12"	1"	725	783	648	542	607
	24"	1"	1,011	1,091	836	730	818
	36"	1"	1,383	1,494	1,148	1,021	1,143
	48"	1"	1,754	1,894	1,441	1,313	1,471
	60"	1"	2,021	2,183	1,610	1,483	1,661
	72"	1"	2,407	2,599	1,903	1,776	1,989
	84"	1"	2,569	2,774	2,002	1,875	2,100
	96"	1"	2,782	3,005	2,114	1,987	2,226
RM6171	12"	1 1/4"	810	875	710	604	676
	24"	1 1/4"	1,385	1,496	1,190	1,063	1,190
	36"	1 1/4"	1,925	2,079	1,604	1,477	1,654
	48"	1 1/4"	2,370	2,560	1,965	1,837	2,058
	60"	1 1/4"	2,697	2,913	2,234	2,107	2,359
	72"	1 1/4"	2,840	3,067	2,370	2,243	2,511
	84"	1 1/4"	2,982	3,221	2,474	2,347	2,628
	96"	1 1/4"	3,125	3,375	2,588	2,460	2,755
RM6172	12"	1 1/2"	915	988	755	649	727
	24"	1 1/2"	1,498	1,618	1,328	1,201	1,345
	36"	1 1/2"	2,080	2,246	1,777	1,650	1,848
	48"	1 1/2"	2,552	2,756	1,987	1,860	2,083
	60"	1 1/2"	3,023	3,266	2,197	2,070	2,318
	72"	1 1/2"	3,195	3,450	2,408	2,281	2,555
	84"	1 1/2"	3,368	3,637	2,618	2,491	2,790
	96"	1 1/2"	3,539	3,822	2,828	2,701	3,026

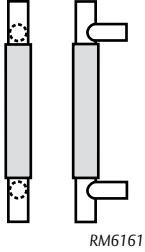

RM6160

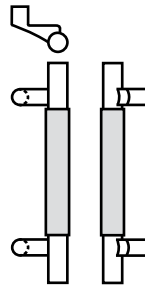

RM6171

- Add \$6.50/in. over 96".
- MP (Mid Post) - Add \$76 each. (Recommended for maximum rigidity on long door pulls. See page 5 for guidelines.)
- FW (Full Wrap) available up to 72" overall length pull - Call for pricing.
- Specify leather color.

NOTE: All long pulls include charge for leather between mounting posts up to a maximum of 72" of leather cover.

Upholstery Leather Pulls (con't)

Straight Pulls - Round Ends							
Part	Max OA	Dia.	3/605 4/606	10/612 10B/613	Stock PC 10BE	32D/ 630	32/ 629
RM6180	12"	1"	769	830	654	547	613
	24"	1"	1,054	1,139	841	735	823
	36"	1"	1,427	1,540	1,153	1,026	1,149
	48"	1"	1,798	1,941	1,446	1,319	1,477
	60"	1"	2,065	2,230	1,616	1,488	1,667
	72"	1"	2,450	2,647	1,909	1,781	1,994
	84"	1"	2,612	2,820	2,007	1,880	2,106
	96"	1"	2,826	3,052	2,120	1,992	2,231
	RM6181	12"	1 1/4"	853	922	715	609
24"		1 1/4"	1,429	1,543	1,196	1,068	1,197
36"		1 1/4"	1,968	2,126	1,609	1,482	1,660
48"		1 1/4"	2,413	2,607	1,970	1,843	2,063
60"		1 1/4"	2,740	2,959	2,240	2,112	2,366
72"		1 1/4"	2,883	3,114	2,375	2,248	2,518
84"		1 1/4"	3,026	3,268	2,479	2,352	2,634
96"		1 1/4"	3,169	3,423	2,593	2,466	2,762
RM6182		12"	1 1/2"	959	1,036	761	655
	24"	1 1/2"	1,542	1,665	1,334	1,206	1,351
	36"	1 1/2"	2,123	2,293	1,782	1,655	1,853
	48"	1 1/2"	2,596	2,803	1,992	1,865	2,089
	60"	1 1/2"	3,067	3,312	2,202	2,075	2,324
	72"	1 1/2"	3,238	3,498	2,414	2,286	2,561
	84"	1 1/2"	3,411	3,684	2,624	2,496	2,795
	96"	1 1/2"	3,583	3,869	2,834	2,706	3,031
	Offset Pulls - Round Ends						
RM6190	12"	1"	807	871	685	579	649
	24"	1"	1,092	1,179	873	767	859
	36"	1"	1,465	1,582	1,185	1,058	1,185
	48"	1"	1,836	1,982	1,478	1,351	1,513
	60"	1"	2,103	2,271	1,648	1,520	1,703
	72"	1"	2,488	2,687	1,940	1,813	2,031
	84"	1"	2,650	2,862	2,039	1,912	2,141
	96"	1"	2,864	3,093	2,152	2,024	2,267
	RM6191	12"	1 1/4"	891	963	747	641
24"		1 1/4"	1,467	1,584	1,227	1,100	1,232
36"		1 1/4"	2,006	2,167	1,641	1,514	1,695
48"		1 1/4"	2,451	2,648	2,002	1,875	2,100
60"		1 1/4"	2,778	3,001	2,271	2,144	2,402
72"		1 1/4"	2,921	3,155	2,407	2,280	2,553
84"		1 1/4"	3,064	3,309	2,511	2,384	2,670
96"		1 1/4"	3,207	3,463	2,625	2,497	2,797
RM6192		12"	1 1/2"	997	1,076	792	686
	24"	1 1/2"	1,580	1,704	1,365	1,238	1,387
	36"	1 1/2"	2,161	2,334	1,814	1,687	1,889
	48"	1 1/2"	2,634	2,844	2,024	1,897	2,125
	60"	1 1/2"	3,105	3,353	2,234	2,107	2,359
	72"	1 1/2"	3,276	3,538	2,445	2,318	2,596
	84"	1 1/2"	3,449	3,725	2,655	2,528	2,832
	96"	1 1/2"	3,621	3,910	2,865	2,738	3,067

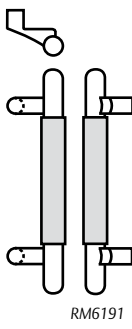
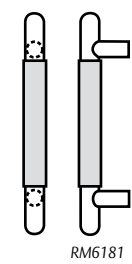

- Add \$6.50/in. over 96".
- MP (Mid Post) - Add \$76 each. (Recommended for maximum rigidity on long door pulls. See page 5 for guidelines.)
- FW (Full Wrap) available up to 72" overall length pull - Call for pricing.
- Specify leather color.

NOTE: All long pulls include charge for leather between mounting posts up to a maximum of 72" of leather cover.

Leather Oval - Ergonomic Pulls

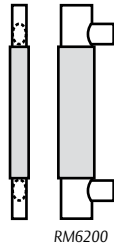

True Oval					
Part	Max OA	Grip Size	Stock PC 10BE	32D/630	32/629
RM6200	12"	1" x 1 1/2"	871	768	861
	24"	1" x 1 1/2"	1,220	1,096	1,227
	36"	1" x 1 1/2"	1,547	1,423	1,594
	48"	1" x 1 1/2"	1,875	1,751	1,961
	60"	1" x 1 1/2"	2,202	2,079	2,328
	72"	1" x 1 1/2"	2,530	2,406	2,695
	84"	1" x 1 1/2"	2,857	2,734	3,062
	96"	1" x 1 1/2"	3,185	3,061	3,428



Flat Oval - 3/4" Diameter Posts					
Part	Max OA	Grip Size	Stock PC 10BE	32D/630	32/629
RM6220	12"	3/4" x 1 1/2"	908	805	902
	24"	3/4" x 1 1/2"	1,251	1,128	1,263
	36"	3/4" x 1 1/2"	1,574	1,450	1,624
	48"	3/4" x 1 1/2"	1,896	1,773	1,985
	60"	3/4" x 1 1/2"	2,219	2,095	2,346
	72"	3/4" x 1 1/2"	2,541	2,417	2,707
	84"	3/4" x 1 1/2"	2,863	2,740	3,069
	96"	3/4" x 1 1/2"	3,186	3,062	3,430

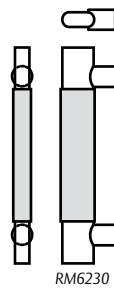

Flat Oval - 1" Diameter Posts					
Part	Max OA	Grip Size	Stock PC 10BE	32D/630	32/629
RM6230	12"	3/4" x 1 1/2"	961	837	938
	24"	3/4" x 1 1/2"	1,283	1,160	1,299
	36"	3/4" x 1 1/2"	1,606	1,482	1,660
	48"	3/4" x 1 1/2"	1,928	1,805	2,021
	60"	3/4" x 1 1/2"	2,251	2,127	2,382
	72"	3/4" x 1 1/2"	2,573	2,449	2,743
	84"	3/4" x 1 1/2"	2,895	2,772	3,104
	96"	3/4" x 1 1/2"	3,218	3,094	3,465

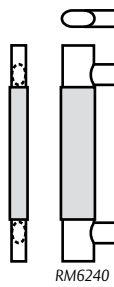

Flat Oval - 3/4" x 1 1/2" Diameter Posts					
Part	Max OA	Grip Size	Stock PC 10BE	32D/630	32/629
RM6240	12"	3/4" x 1 1/2"	1,083	959	1,074
	24"	3/4" x 1 1/2"	1,405	1,281	1,435
	36"	3/4" x 1 1/2"	1,727	1,604	1,796
	48"	3/4" x 1 1/2"	2,050	1,926	2,157
	60"	3/4" x 1 1/2"	2,372	2,248	2,518
	72"	3/4" x 1 1/2"	2,694	2,571	2,879
	84"	3/4" x 1 1/2"	3,017	2,893	3,240
	96"	3/4" x 1 1/2"	3,339	3,216	3,602

- Add \$6.50/in. over 96".
- MP (Mid Post) - Add \$68 each. (Recommended for maximum rigidity on long door pulls. See page 5 for guidelines.)
- Specify leather color.

NOTE: All long pulls include charge for leather between mounting posts up to a maximum of 72" of leather cover.

Flush Leather Pulls

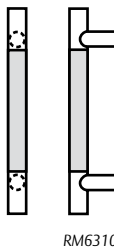

Straight Pulls - Flat Ends							
Part	Max OA	Dia.	3/605 4/606	10/612 10B/613	Stock PC 10BE	32D/630	32/629
RM6300	12"	1"	816	881	750	647	724
	24"	1"	1,217	1,315	1,140	1,017	1,139
	36"	1"	1,619	1,749	1,510	1,386	1,553
	48"	1"	2,021	2,183	1,880	1,756	1,967
	60"	1"	2,423	2,616	2,250	2,126	2,381
	72"	1"	2,824	3,050	2,619	2,496	2,795
	84"	1"	3,226	3,484	2,989	2,865	3,209
	96"	1"	3,628	3,918	3,359	3,235	3,623
RM6310	12"	1 1/4"	979	1,057	871	768	861
	24"	1 1/4"	1,397	1,508	1,264	1,140	1,277
	36"	1 1/4"	1,815	1,960	1,636	1,512	1,693
	48"	1 1/4"	2,233	2,412	2,007	1,884	2,110
	60"	1 1/4"	2,651	2,863	2,379	2,256	2,526
	72"	1 1/4"	3,069	3,315	2,751	2,628	2,943
	84"	1 1/4"	3,488	3,767	3,123	2,999	3,359
	96"	1 1/4"	3,906	4,218	3,495	3,371	3,776
RM6320	12"	1 1/2"	1,059	1,144	969	846	947
	24"	1 1/2"	1,488	1,607	1,352	1,229	1,376
	36"	1 1/2"	1,918	2,071	1,736	1,612	1,805
	48"	1 1/2"	2,347	2,535	2,119	1,995	2,235
	60"	1 1/2"	2,777	2,999	2,502	2,378	2,664
	72"	1 1/2"	3,206	3,463	2,885	2,761	3,093
	84"	1 1/2"	3,636	3,927	3,268	3,145	3,522
	96"	1 1/2"	4,065	4,391	3,651	3,528	3,951

ASSA ABLOY

Opening Solutions

The global leader in door opening solutions

Flush Leather Pulls (cont')

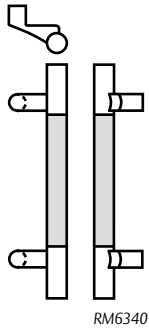

RM6340

Offset Pulls - Flat Ends							
Part	Max OA	Dia.	3/605 4/606	10/612 108/613	Stock PC 10BE	32D/630	32/629
RM6330	12"	1"	852	920	786	683	765
	24"	1"	1,254	1,354	1,176	1,053	1,179
	36"	1"	1,655	1,788	1,546	1,422	1,593
	48"	1"	2,057	2,221	1,916	1,792	2,007
	60"	1"	2,459	2,655	2,286	2,162	2,421
	72"	1"	2,860	3,089	2,655	2,532	2,836
	84"	1"	3,262	3,523	3,025	2,902	3,250
	96"	1"	3,664	3,957	3,395	3,271	3,664
	RM6340	12"	1 1/4"	1,015	1,096	907	804
24"		1 1/4"	1,433	1,547	1,300	1,176	1,317
36"		1 1/4"	1,851	1,999	1,672	1,548	1,734
48"		1 1/4"	2,269	2,451	2,044	1,920	2,150
60"		1 1/4"	2,687	2,902	2,415	2,292	2,567
72"		1 1/4"	3,105	3,354	2,787	2,664	2,983
84"		1 1/4"	3,524	3,806	3,159	3,035	3,400
96"		1 1/4"	3,942	4,257	3,531	3,407	3,816
RM6350		12"	1 1/2"	1,095	1,182	1,005	882
	24"	1 1/2"	1,524	1,646	1,388	1,265	1,417
	36"	1 1/2"	1,954	2,110	1,772	1,648	1,846
	48"	1 1/2"	2,383	2,574	2,155	2,031	2,275
	60"	1 1/2"	2,813	3,038	2,538	2,414	2,704
	72"	1 1/2"	3,242	3,502	2,921	2,797	3,133
	84"	1 1/2"	3,672	3,966	3,304	3,181	3,562
	96"	1 1/2"	4,101	4,430	3,687	3,564	3,991
	Straight Pulls - Round Ends						
RM6304	12"	1"	898	970	796	693	776
	24"	1"	1,300	1,404	1,187	1,063	1,191
	36"	1"	1,702	1,838	1,556	1,433	1,605
	48"	1"	2,103	2,272	1,926	1,803	2,019
	60"	1"	2,505	2,705	2,296	2,172	2,433
	72"	1"	2,907	3,139	2,666	2,542	2,847
	84"	1"	3,308	3,573	3,035	2,912	3,261
	96"	1"	3,710	4,007	3,405	3,282	3,675
	RM6314	12"	1 1/4"	1,061	1,146	918	815
24"		1 1/4"	1,479	1,597	1,310	1,187	1,329
36"		1 1/4"	1,897	2,049	1,682	1,558	1,745
48"		1 1/4"	2,315	2,501	2,054	1,930	2,162
60"		1 1/4"	2,734	2,952	2,426	2,302	2,578
72"		1 1/4"	3,152	3,404	2,797	2,674	2,995
84"		1 1/4"	3,570	3,856	3,169	3,046	3,411
96"		1 1/4"	3,988	4,307	3,541	3,418	3,828
RM6324		12"	1 1/2"	1,141	1,233	1,016	892
	24"	1 1/2"	1,571	1,696	1,399	1,275	1,428
	36"	1 1/2"	2,000	2,160	1,782	1,658	1,857
	48"	1 1/2"	2,430	2,624	2,165	2,041	2,286
	60"	1 1/2"	2,859	3,088	2,548	2,425	2,716
	72"	1 1/2"	3,289	3,552	2,931	2,808	3,145
	84"	1 1/2"	3,718	4,016	3,315	3,191	3,574
	96"	1 1/2"	4,148	4,480	3,698	3,574	4,003

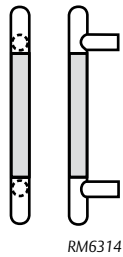

RM6314

- Add \$6.50/in. over 96".
- Up to 96" available with mid-post (Recommended for maximum rigidity on long door pulls. See page 5 for guidelines.)
- Specify leather type and color.

Flush Leather Pulls (cont')

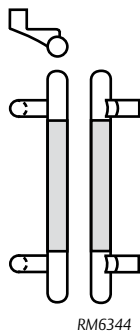

Offset Pulls - Round Ends							
Part	Max OA	Dia.	3/605 4/606	10/612 10B/613	Stock PC 10BE	32D/630	32/629
RM6334	12"	1"	934	1,009	832	729	817
	24"	1"	1,336	1,443	1,223	1,099	1,231
	36"	1"	1,738	1,877	1,592	1,469	1,645
	48"	1"	2,139	2,310	1,962	1,839	2,059
	60"	1"	2,541	2,744	2,332	2,208	2,473
	72"	1"	2,943	3,178	2,702	2,578	2,887
	84"	1"	3,344	3,612	3,071	2,948	3,302
RM6344	12"	1 1/4"	1,097	1,185	974	851	953
	24"	1 1/4"	1,515	1,636	1,346	1,223	1,369
	36"	1 1/4"	1,933	2,088	1,718	1,594	1,786
	48"	1 1/4"	2,351	2,540	2,090	1,966	2,202
	60"	1 1/4"	2,770	2,991	2,462	2,338	2,619
	72"	1 1/4"	3,188	3,443	2,834	2,710	3,035
	84"	1 1/4"	3,606	3,895	3,205	3,082	3,452
RM6354	12"	1 1/2"	1,177	1,271	1,052	928	1,039
	24"	1 1/2"	1,607	1,735	1,435	1,311	1,469
	36"	1 1/2"	2,036	2,199	1,818	1,694	1,898
	48"	1 1/2"	2,466	2,663	2,201	2,078	2,327
	60"	1 1/2"	2,895	3,127	2,584	2,461	2,756
	72"	1 1/2"	3,325	3,591	2,967	2,844	3,185
	84"	1 1/2"	3,754	4,055	3,351	3,227	3,614
96"	1 1/2"	4,184	4,519	3,734	3,610	4,043	

- Add \$6.50/in. over 96".
- Up to 96" available with mid-post (Recommended for maximum rigidity on long door pulls. See page 5 for guidelines.)
- Specify leather type and color.

Upholstery Leather GeoMetek - Narrow Profile Pulls

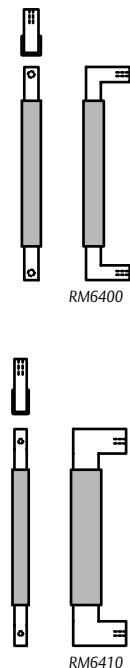

Straight Square End Pulls					
Part	CTC	Grip Size	Stock PC 10BE	32D/630	32/629
RM6400	12"	3/4" x 3/4"	608	502	562
	24"	3/4" x 3/4"	976	849	951
	36"	3/4" x 3/4"	1,323	1,196	1,339
	48"	3/4" x 3/4"	1,670	1,543	1,728
RM6440	12"	1 1/4" x 1 1/4"	705	599	671
	24"	1 1/4" x 1 1/4"	1,165	1,038	1,162
	36"	1 1/4" x 1 1/4"	1,603	1,476	1,653
	48"	1 1/4" x 1 1/4"	2,041	1,914	2,144
Straight Rectangular End Pulls					
RM6410	12"	3/4" x 1 1/2"	711	605	677
	24"	3/4" x 1 1/2"	1,024	896	1,004
	36"	3/4" x 1 1/2"	1,316	1,188	1,331
	48"	3/4" x 1 1/2"	1,607	1,480	1,658
	60"	3/4" x 1 1/2"	1,899	1,772	1,984
	72"	3/4" x 1 1/2"	2,191	2,063	2,311
	84"	3/4" x 1 1/2"	2,483	2,355	2,638
	96"	3/4" x 1 1/2"	2,774	2,647	2,965

Offset Square End Pulls					
Part	CTC	Grip Size	Stock PC 10BE	32D/630	32/629
RM6420	12"	3/4" x 3/4"	645	539	604
	24"	3/4" x 3/4"	1,013	886	992
	36"	3/4" x 3/4"	1,360	1,233	1,381
	48"	3/4" x 3/4"	1,707	1,580	1,769
Offset Rectangular End Pulls					
RM6430	12"	3/4" x 1 1/2"	748	642	719
	24"	3/4" x 1 1/2"	1,061	934	1,046
	36"	3/4" x 1 1/2"	1,353	1,225	1,372
	48"	3/4" x 1 1/2"	1,644	1,517	1,699
	60"	3/4" x 1 1/2"	1,936	1,809	2,026
	72"	3/4" x 1 1/2"	2,228	2,101	2,353
	96"	3/4" x 1 1/2"	2,811	2,684	3,006

ASSA ABLOY

Opening Solutions

The global leader in door opening solutions

USA & Canada Prices Effective June 3, 2019

Copyright © 2019, ASSA ABLOY Accessories and Door Controls Group, Inc. All rights reserved. Reproduction in whole or in part without the express written permission of ASSA ABLOY Accessories and Door Controls Group, Inc. is prohibited.

Leather - Small Pulls for Cabinets, Casework & Closet Doors

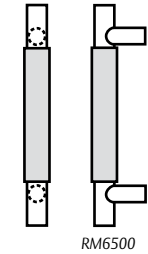

RM6500

Straight Surface Wrapped - Flat Ends							
Part	Max OA	Dia.	3/605 4/606	10/612 108/613	Stock PC 10BE	32D/630	32/629
RM6500-4	5 7/8"	1/2"	179	193	190	138	147
RM6500-5	6 7/8"	1/2"	191	206	200	148	159
RM6510-5	6 7/8"	5/8"	219	237	228	176	190
RM6510-6	7 7/8"	5/8"	246	266	253	202	215

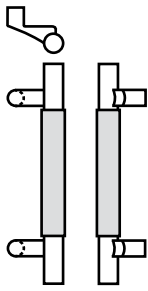

RM6530

Offset Surface Wrapped - Flat Ends							
RM6530-5	7"	5/8"			295	226	242
RM6530-6	8"	5/8"			321	250	268

Straight Surface Wrapped - Round Ends							
RM6540-4	5 7/8"	1/2"	197	213	207	156	166
RM6540-5	6 7/8"	1/2"	211	229	219	168	179
RM6550-5	7"	5/8"	239	259	246	195	208
RM6550-6	8"	5/8"	265	286	286	218	234

Offset Surface Wrapped - Round Ends							
RM6570-5	7"	5/8"			315	244	261
RM6570-6	8"	5/8"			342	269	287

Straight Flush Wrapped - Flat Ends							
RM6610-5	6 7/8"	5/8"	246	266	238	186	199
RM6610-6	7 7/8"	5/8"	277	300	299	216	231

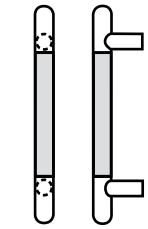

RM6650

Offset Flush Wrapped - Flat Ends							
RM6630-5	6 7/8"	5/8"			308	226	242
RM6630-6	7 7/8"	5/8"			340	258	275

Straight Flush Wrapped - Round Ends							
RM6650-5	6 7/8"	5/8"	260	279	250	199	212
RM6650-6	7 7/8"	5/8"	291	315	311	229	245

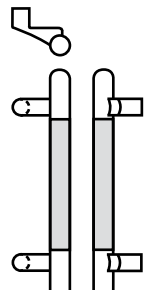

RM6670

Offset Flush Wrapped - Round Ends							
RM6670-5	6 7/8"	5/8"			321	239	255
RM6670-6	7 7/8"	5/8"			351	269	287

Straight Full Wrapped - Flat Ends							
RM6700-4	5 7/8"	1/2"	205	220	220	178	192
RM6700-5	6 7/8"	1/2"	231	248	248	202	215
RM6710-5	6 7/8"	5/8"	251	272	272	221	238
RM6710-6	7 7/8"	5/8"	282	304	304	250	268

Offset Full Wrapped - Flat Ends							
RM6730-5	6 7/8"	5/8"			318	262	279
RM6730-6	7 7/8"	5/8"			349	290	310

- Any size made to order.
- Specify leather type and color.

NeoCylinder - with or without GripZone

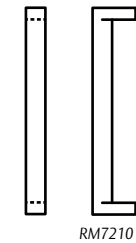

Straight Pulls without GripZone					
Part	CTC	Dia.	Stock PC 10BE	32D/630	32/629
RM7210	12"	1 1/4"	400	303	339
	24"	1 1/4"	453	354	397
	36"	1 1/4"	505	406	454

RM7210

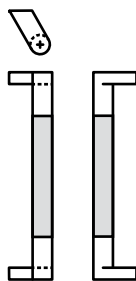

Offset Pulls without GripZone					
Part	CTC	Dia.	Stock PC 10BE	32D/630	32/629
RM7220	12"	1 1/4"	440	342	383
	24"	1 1/4"	492	393	441
	36"	1 1/4"	546	445	499

Straight Pulls with GripZone					
Part	CTC	Dia.	Stock PC 10BE	32D/630	32/629
RM7230	12"	1 1/4"			451
	24"	1 1/4"			509
	36"	1 1/4"			568

Offset Pulls with GripZone					
Part	CTC	Dia.	Stock PC 10BE	32D/630	32/629
RM7240	12"	1 1/4"			490
	24"	1 1/4"			549
	36"	1 1/4"			607

Push Bar without GripZone					
Part	CTC	Dia.	Stock PC 10BE	32D/630	32/629
RM7212	Up to 36"	1 1/4"	505	406	454

RM7240

Push Bar with GripZone					
Part	CTC	Dia.	Stock PC 10BE	32D/630	32/629
RM7232	Up to 36"	1 1/4"			568

• Add \$6.50/in. over 36".

NeoMitre - with or without GripZone

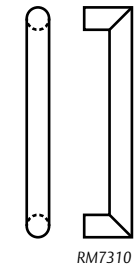

Straight Pulls without GripZone					
Part	CTC	Dia.	Stock PC 10BE	32D/630	32/629
RM7300	12"	1"	423	327	366
	24"	1"	495	398	445
	36"	1"	589	468	524
RM7310	12"	1 1/4"	569	448	502
	24"	1 1/4"	611	489	547
	36"	1 1/4"	652	529	593
RM7320	12"	1 1/2"	654	531	595
	24"	1 1/2"	697	574	643
	36"	1 1/2"	740	616	689

RM7310

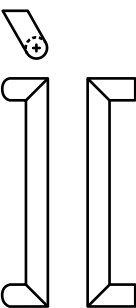

Offset Pulls without GripZone					
Part	CTC	Dia.	Stock PC 10BE	32D/630	32/629
RM7330	12"	1"	462	366	409
	24"	1"	534	436	488
	36"	1"	629	507	568
RM7340	12"	1 1/4"	609	486	545
	24"	1 1/4"	650	527	590
	36"	1 1/4"	692	569	637
RM7350	12"	1 1/2"	694	571	639
	24"	1 1/2"	737	613	686
	36"	1 1/2"	779	654	732

RM7340

Push Bars without GripZone					
Part	CTC	Dia.	Stock PC 10BE	32D/630	32/629
RM7302	Up to 36"	1"	589	468	524
RM7312	Up to 36"	1 1/4"	652	529	593
RM7322	Up to 36"	1 1/2"	740	616	689

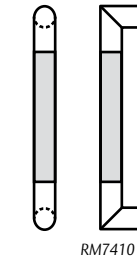

Straight Pulls with GripZone			
Part	CTC	Dia.	32/629
RM7400	12"	1"	476
	24"	1"	555
	36"	1"	634
RM7410	12"	1 1/4"	612
	24"	1 1/4"	658
	36"	1 1/4"	703
RM7420	12"	1 1/2"	706
	24"	1 1/2"	753
	36"	1 1/2"	800

RM7410

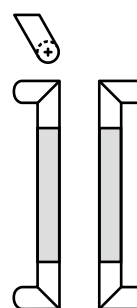

Offset Pulls with GripZone			
Part	CTC	Dia.	32/629
RM7430	12"	1"	519
	24"	1"	598
	36"	1"	678
RM7440	12"	1 1/4"	655
	24"	1 1/4"	701
	36"	1 1/4"	747
RM7450	12"	1 1/2"	749
	24"	1 1/2"	796
	36"	1 1/2"	844

RM7440

Push Bars with GripZone			
Part	CTC	Dia.	32/629
RM7402	Up to 36"	1"	634
RM7412	Up to 36"	1 1/4"	703
RM7422	Up to 36"	1 1/2"	800

• Add \$6.50/in. over 36".

NOTE: Post location on push bars can be located 1/8" from end for narrow & medium stile doors and 1" from end for flush and wide stile doors.

ASSA ABLOY

Opening Solutions

The global leader in door opening solutions

GeoMetek - Hex Pulls

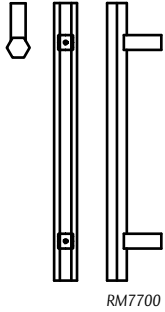

Flat End - Square Post					
Part	Max OA	Grip	Stock PC 10BE	32D/630	32/629
RM7700	12"	1"	487	388	434
	24"	1"	553	431	483
	36"	1"	599	475	531
	48"	1"	644	518	581
	60"	1"	689	562	629
	72"	1"	734	605	678
	84"	1"	779	648	726
	96"	1"	824	692	775

• Add \$9.70/in. over 96".

GeoMetek - Diamond Pulls

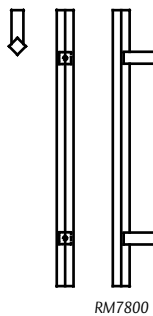

Flat End - Square Post					
Part	Max OA	Grip	Stock PC 10BE	32D/630	32/629
RM7800	12"	3/4" x 3/4"	413	311	348
	24"	3/4" x 3/4"	457	354	397
	36"	3/4" x 3/4"	502	398	445
	48"	3/4" x 3/4"	569	440	493

Flat End - Diamond Post					
Part	Max OA	Grip	Stock PC 10BE	32D/630	32/629
RM7805	12"	3/4" x 3/4"	440	337	378
	24"	3/4" x 3/4"	484	381	426
	36"	3/4" x 3/4"	530	424	476
	48"	3/4" x 3/4"	597	468	523

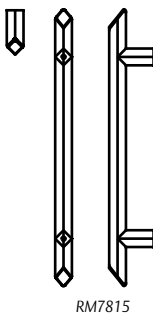

Diamond End - Square Post					
Part	Max OA	Grip	Stock PC 10BE	32D/630	32/629
RM7810	12"	3/4" x 3/4"	573	444	513
	24"	3/4" x 3/4"	618	488	546
	36"	3/4" x 3/4"	664	531	596
	48"	3/4" x 3/4"	709	575	643

Diamond End - Diamond Post					
Part	Max OA	Grip	Stock PC 10BE	32D/630	32/629
RM7815	12"	3/4" x 3/4"	602	472	528
	24"	3/4" x 3/4"	646	514	577
	36"	3/4" x 3/4"	692	559	626
	48"	3/4" x 3/4"	736	601	673

• Add \$9.70/in. over 48".

GeoMetek - Narrow Profile Pulls

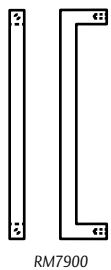

Straight Square End Pulls					
Part	CTC	Grip Size	Stock PC 10BE	32D/630	32/629
RM7900	12"	3/4" x 3/4"	273	207	231
	24"	3/4" x 3/4"	352	250	280
	36"	3/4" x 3/4"	398	294	329
	48"	3/4" x 3/4"	444	338	379
RM7907	12"	1" x 1"	300	228	255
	24"	1" x 1"	387	275	308
	36"	1" x 1"	438	323	362
	48"	1" x 1"	488	372	417
RM7940	12"	1 1/4" x 1 1/4"	364	262	294
	24"	1 1/4" x 1 1/4"	417	312	349
	36"	1 1/4" x 1 1/4"	469	362	405
	48"	1 1/4" x 1 1/4"	520	411	459

• Add \$9.70/in. over 48".

GeoMetek - Narrow Profile Pulls (cont')

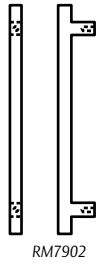

Straight Square Bridge Pulls					
Part	Max OA	Grip Size	Stock PC/10BE	32D/630	32/629
RM7902	12"	3/4" x 3/4"	356	255	285
	24"	3/4" x 3/4"	401	297	333
	36"	3/4" x 3/4"	446	341	382
	48"	3/4" x 3/4"	491	383	429
RM7917	12"	1" x 1"	392	281	315
	24"	1" x 1"	441	327	366
	36"	1" x 1"	491	375	420
	48"	1" x 1"	541	421	472

Straight Rectangular End Pulls					
Part	CTC	Grip Size	Stock PC/10BE	32D/630	32/629
RM7910	12"	3/4" x 1 1/2"	340	239	267
	24"	3/4" x 1 1/2"	525	415	465
	36"	3/4" x 1 1/2"	733	592	663
	48"	3/4" x 1 1/2"	915	768	860

Straight Rectangular Bridge Pulls					
Part	Max OA	Grip Size	Stock PC/10BE	32D/630	32/629
RM7912	12"	3/4" x 1 1/2"	387	284	318
	24"	3/4" x 1 1/2"	595	460	516
	36"	3/4" x 1 1/2"	780	637	713
	48"	3/4" x 1 1/2"	965	813	910

Offset Pulls					
Part	CTC	Grip Size	Stock PC/10BE	32D/630	32/629
RM7920	12"	3/4" x 3/4"	342	241	269
	24"	3/4" x 3/4"	384	281	315
	36"	3/4" x 3/4"	427	323	361
	48"	3/4" x 3/4"	470	363	406
RM7927	12"	1" x 1"	377	265	297
	24"	1" x 1"	423	309	346
	36"	1" x 1"	470	355	398
	48"	1" x 1"	518	399	447
RM7930	12"	3/4" x 1 1/2"	385	282	316
	24"	3/4" x 1 1/2"	584	450	504
	36"	3/4" x 1 1/2"	761	619	693
	48"	3/4" x 1 1/2"	937	786	881

Offset Square Bridge Pull					
Part	Max OA	Grip Size	Stock PC/10BE	32D/630	32/629
RM7925	12"	3/4" x 3/4"	389	290	325
	24"	3/4" x 3/4"	433	332	372
	36"	3/4" x 3/4"	479	376	421
	48"	3/4" x 3/4"	544	418	468
RM7937	12"	1" x 1"	408	305	342
	24"	1" x 1"	455	349	391
	36"	1" x 1"	503	395	442
	48"	1" x 1"	571	439	492

Offset Rectangular Bridge Pull					
Part	Max OA	Grip Size	Stock PC/10BE	32D/630	32/629
RM7935	12"	3/4" x 1 1/2"	419	319	357
	24"	3/4" x 1 1/2"	625	495	554
	36"	3/4" x 1 1/2"	811	672	753
	48"	3/4" x 1 1/2"	1,016	848	950

Straight Rectangular End Stepped Post Pull					
Part	CTC	Grip Size	Stock PC/10BE	32D/630	32/629
RM7960	12"	3/4" x 3/4"	387	284	318
	24"	3/4" x 3/4"	439	333	373
	36"	3/4" x 3/4"	489	381	426
	48"	3/4" x 3/4"	563	430	482

Straight Rectangular End Stepped Post Cast Pull					
Part	CTC	Grip Size	3/605 4/606	10/612 108/613	15/619
RM7960	12"	3/4" x 3/4"	374	384	409

• Add \$9.70/in. over 48".

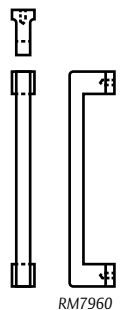
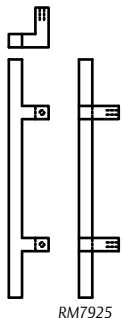
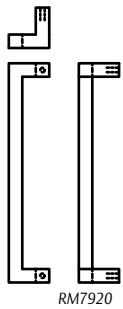

ASSA ABLOY

Opening Solutions

The global leader in
door opening solutions

Locking Door Pulls

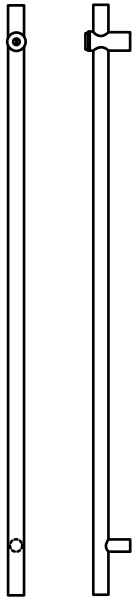

LP3301DBD

PostMount - Round						
Part	Description	3/605 4/606	Stock PC 10BE	10B/613 10BL/614	32/629	32D/630
LP3301DBD	Half Height Pull - Bolts Down	1,822	1,419	1,968	1,172	1,048
LP3301DBU	Half Height Pull - Bolts Up	1,999	1,513	2,160	1,266	1,130
LP3301FHD	Full Height Pull - Bolts Down	2,212	1,604	2,391	1,357	1,211
LP3301FHU	Full Height Pull - Bolts Up	2,427	1,711	2,621	1,464	1,307
LP3301FHB	Full Height Pull - Bolts Up and Down	2,672	1,967	2,885	1,720	1,535
Horizontal Push/Pull Bar Option - Half Height – Bolts Down (DBD)						
LP3301DBDBEPB	Bent End Both Sides	2,424	1,808	2,617	1,560	1,393
LP3301DBDBEPT	Bent End Thumbturn Side - Mating Side Vertical	2,123	1,614	2,293	1,367	1,221
LP3301DBDBEPC	Bent End Cylinder Side - Mating Side Vertical	2,123	1,614	2,293	1,367	1,221
LP3301DBDPMPB	Post Mount Both Sides	2,659	1,930	2,873	1,683	1,502
LP3301DBDPMPT	Post Mount Thumbturn Side - Mating Side Vertical	2,330	1,721	2,515	1,474	1,315
LP3301DBDPMPC	Post Mount Cylinder Side - Mating Side Vertical	2,330	1,721	2,515	1,474	1,315
Horizontal Push/Pull Bar Option - Half Height – Bolts Up (DBU)						
LP3301DBUBEPB	Bent End Both Sides	2,424	1,808	2,617	1,560	1,393
LP3301DBUBEPT	Bent End Thumbturn Side - Mating Side Vertical	2,123	1,614	2,293	1,367	1,221
LP3301DBUBEPC	Bent End Cylinder Side - Mating Side Vertical	2,123	1,614	2,293	1,367	1,221
LP3301DBUPMPB	Post Mount Both Sides	2,659	1,930	2,873	1,683	1,502
LP3301DBUPMPT	Post Mount Thumbturn Side - Mating Side Vertical	2,330	1,721	2,515	1,474	1,315
LP3301DBUPMPC	Post Mount Cylinder Side - Mating Side Vertical	2,330	1,721	2,515	1,474	1,315

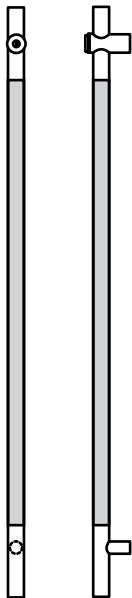

LP3401DBD

NeoTek with GripZone - Round				
Part	Description	3/605	32/629	
LP3401DBD	Half Height Pull - Bolts Down	1,953	1,259	
LP3401DBU	Half Height Pull - Bolts Up	2,142	1,357	
LP3401FHD	Full Height Pull - Bolts Down	2,342	1,452	
LP3401FHU	Full Height Pull - Bolts Up	2,570	1,566	
LP3401FHB	Full Height Pull - Bolts Up and Down	2,816	1,793	
Horizontal Push/Pull Bar Option - Half Height – Bolts Down (DBD)				
LP3401DBDBEPB	Bent End Both Sides	2,597	1,674	
LP3401DBDBEPT	Bent End Thumbturn Side - Mating Side Vertical	2,275	1,466	
LP3401DBDBEPC	Bent End Cylinder Side - Mating Side Vertical	2,275	1,466	
LP3401DBDPMPB	Post Mount Both Sides	2,597	1,674	
LP3401DBDPMPT	Post Mount Thumbturn Side - Mating Side Vertical	2,275	1,466	
LP3401DBDPMPC	Post Mount Cylinder Side - Mating Side Vertical	2,275	1,466	
Horizontal Push/Pull Bar Option - Half Height – Bolts Up (DBU)				
LP3401DBUBEPB	Bent End Both Sides	2,850	1,805	
LP3401DBUBEPT	Bent End Thumbturn Side - Mating Side Vertical	2,496	1,581	
LP3401DBUBEPC	Bent End Cylinder Side - Mating Side Vertical	2,496	1,581	
LP3401DBUPMPB	Post Mount Both Sides	2,850	1,805	
LP3401DBUPMPT	Post Mount Thumbturn Side - Mating Side Vertical	2,496	1,581	
LP3401DBUPMPC	Post Mount Cylinder Side - Mating Side Vertical	2,496	1,581	

- DBD and DBU priced as 51" overall. Add \$13/in. over 96" long for full height or 51" long for half height.
- Horizontal Push/Pull Option, add \$13/in. over 36".

NOTE: New square Locking Pulls only available in US10BE, US32, and US32D.

Locking Door Pulls (con't)

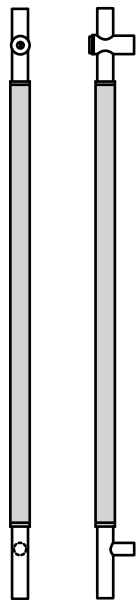

LP6061DBD

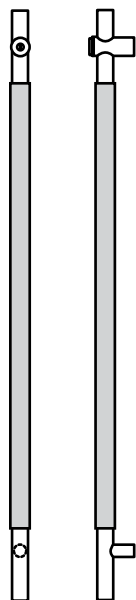

LP6161DBD

English Bridle Leather Wrapped - Round						
Part	Description	3/605 4/606	Stock PC 10BE	10B/613 10BL/614	32/629	32D/630
LP6061DBD	Half Height Pull - Bolts Down	5,074	4,266	5,480	4,640	4,143
LP6061DBU	Half Height Pull - Bolts Up	5,251	4,360	5,671	4,723	4,236
LP6061FHD	Full Height Pull - Bolts Down	6,461	5,492	6,977	6,012	5,368
LP6061FHU	Full Height Pull - Bolts Up	6,675	5,599	7,208	6,108	5,475
LP6061FHB	Full Height Pull - Bolts Up and Down	6,921	5,856	7,472	6,336	5,732
Horizontal Push/Pull Bar Option - Half Height - Bolts Down (DBD)						
LP6061DBDBECP*	Bent End Both Sides	6,591	5,086	7,118	5,518	4,963
LP6061DBDBEPT*	Bent End Thumbturn Side - Mating Side Vertical	5,832	4,676	6,299	5,079	4,553
LP6061DBDBEPC*	Bent End Cylinder Side - Mating Side Vertical	5,832	4,676	6,299	5,079	4,553
LP6061DBDPMPB*	Post Mount Both Sides	6,591	5,086	7,118	5,518	4,963
LP6061DBDPMPPT*	Post Mount Thumbturn Side - Mating Side Vertical	5,832	4,676	6,299	5,079	4,553
LP6061DBDPMPCC*	Post Mount Cylinder Side - Mating Side Vertical	5,832	4,676	6,299	5,079	4,553
Horizontal Push/Pull Bar Option - Half Height - Bolts Up (DBU)						
LP6061DBUBECP*	Bent End Both Sides	6,768	5,180	7,310	5,600	5,056
LP6061DBUBEPT*	Bent End Thumbturn Side - Mating Side Vertical	6,009	4,770	6,491	5,161	4,646
LP6061DBUBEPC*	Bent End Cylinder Side - Mating Side Vertical	6,009	4,770	6,491	5,161	4,646
LP6061DBUPMPB*	Post Mount Both Sides	6,768	5,180	7,310	5,600	5,056
LP6061DBUPMPPT*	Post Mount Thumbturn Side - Mating Side Vertical	6,009	4,770	6,491	5,161	4,646
LP6061DBUPMPCC*	Post Mount Cylinder Side - Mating Side Vertical	6,009	4,770	6,491	5,161	4,646
PostMount Upholstery Leather Wrapped - Round						
LP6161DBD	Half Height Pull - Bolts Down	4,975	4,180	5,372	4,543	4,056
LP6161DBU	Half Height Pull - Bolts Up	5,152	4,273	5,564	4,626	4,150
LP6161FHD	Full Height Pull - Bolts Down	6,137	5,169	6,628	5,651	5,045
LP6161FHU	Full Height Pull - Bolts Up	6,351	5,276	6,859	5,746	5,152
LP6161FHB	Full Height Pull - Bolts Up and Down	6,596	5,532	7,122	5,974	5,409
Horizontal Push/Pull Bar Option - Half Height - Bolts Down (DBD)						
LP6161DBDBECP*	Bent End Both Sides	6,428	4,987	6,942	5,408	4,864
LP6161DBDBEPT*	Bent End Thumbturn Side - Mating Side Vertical	5,701	4,585	6,157	4,948	4,489
LP6161DBDBEPC*	Bent End Cylinder Side - Mating Side Vertical	5,701	4,585	6,157	4,948	4,489
LP6161DBDPMPB*	Post Mount Both Sides	6,428	4,987	6,942	5,408	4,864
LP6161DBDPMPPT*	Post Mount Thumbturn Side - Mating Side Vertical	5,701	4,585	6,157	4,948	4,489
LP6161DBDPMPCC*	Post Mount Cylinder Side - Mating Side Vertical	5,701	4,585	6,157	4,948	4,489
Horizontal Push/Pull Bar Option - Half Height - Bolts Up (DBU)						
LP6161DBUBECP*	Bent End Both Sides	6,605	5,081	7,134	5,490	4,957
LP6161DBUBEPT*	Bent End Thumbturn Side - Mating Side Vertical	5,878	4,678	6,349	5,031	4,582
LP6161DBUBEPC*	Bent End Cylinder Side - Mating Side Vertical	5,878	4,678	6,349	5,031	4,582
LP6161DBUPMPB*	Post Mount Both Sides	6,605	5,081	7,134	5,490	4,957
LP6161DBUPMPPT*	Post Mount Thumbturn Side - Mating Side Vertical	5,878	4,678	6,349	5,031	4,582
LP6161DBUPMPCC*	Post Mount Cylinder Side - Mating Side Vertical	5,878	4,678	6,349	5,031	4,582

• DBD and DBU priced as 51" overall. Add \$13/in. over 96" long for full height or 51" long for half height.

* Price includes up to 42" of English Bridle Leather on vertical.

Other options available upon request.

NOTE: New square Locking Pulls only available in US10BE, US32, and US32D.

ASSA ABLOY

Opening Solutions

The global leader in door opening solutions

Locking Door Pulls (con't)

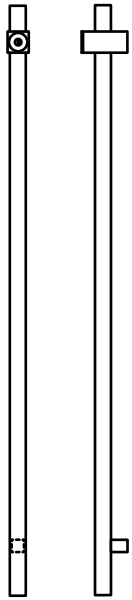

LP7901DBD

GeoMetek Upholstery Leather Wrapped - Square						
Part	Description	3/605 4/606	Stock PC 10BE	10B/613 10BL/614	32/629	32D/630
LP6440DBD	Half Height Pull - Bolts Down		4,392		4,780	4,268
LP6440DBU	Half Height Pull - Bolts Up		4,486		4,863	4,362
LP6440FHD	Full Height Pull - Bolts Down		5,381		5,887	5,257
LP6440FHU	Full Height Pull - Bolts Up		5,488		5,983	5,364
LP6440FHB	Full Height Pull - Bolts Up and Down		5,744		6,211	5,621
GeoMetek - Square						
LP7901DBD	Half Height Pull - Bolts Down		1,504		1,344	1,257
LP7901DBU	Half Height Pull - Bolts Up		1,602		1,449	1,354
LP7901FHD	Full Height Pull - Bolts Down		1,702		1,556	1,454
LP7901FHU	Full Height Pull - Bolts Up		1,815		1,677	1,568
LP7901FHB	Full Height Pull - Bolts Up and Down		2,088		1,969	1,841
MegaTek Dummy Pull - Round						
DP3301DBD	Half Height Pull - Bolts Down	1,430	1,086	1,545	896	838
DP3301DBU	Half Height Pull - Bolts Up	1,430	1,086	1,545	896	838
DP3301FHD	Full Height Pull - Bolts Down	1,953	1,338	2,109	1,167	1,091
DP3301FHU	Full Height Pull - Bolts Up	1,953	1,338	2,109	1,167	1,091
NeoTek with GripZone Dummy Pull - Round						
DP3401DBD	Half Height Pull - Bolts Down	1,532			1,006	
DP3401DBU	Half Height Pull - Bolts Up	1,532			1,006	
DP3401FHD	Full Height Pull - Bolts Down	2,067			1,307	
DP3401FHU	Full Height Pull - Bolts Up	2,067			1,307	
GeoMetek Dummy Pull - Square						
DP7901DBD	Half Height Pull - Bolts Down		1,251		1,074	1,004
DP7901DBU	Half Height Pull - Bolts Up		1,251		1,074	1,004
DP7901FHD	Full Height Pull - Bolts Down		1,556		1,401	1,309
DP7901FHU	Full Height Pull - Bolts Up		1,556		1,401	1,309

• DBD and DBU priced as 51" overall. Add \$13/in. over 96" long for full height or 51" long for half height.
 * Price includes up to 42" of Upholstry Leather on vertical. Other options available upon request.

NOTE: New Square Locking Pulls only available in US10BE, US32, and US32D.

Locking Door Pull Accessories

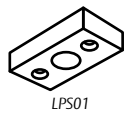

LPS01



570

Part	Description	Stock PC 10BE	28/628	32/629	32D/630	
LPS01	Top Strike - 3/4" x 1 1/2" x 3"	40	40	77	69	
LPS02	Top Strike - w/Rubber Stop - 3/4" x 2 1/2" x 3"	40	40	77	69	
LPS03	Top Strike - Stainless Steel - .050" x 1 1/8" x 2 1/4"	40		36	32	
LPS04	Transom Strike - 1 1/4"D x 4"H	130		105	94	
LPS05	Transom Strike - 1 1/4"SQ x 4 1/2"H	151		122	109	
LPS06	Mortised Header Strike 2" Dia.	237		193	172	
Part	Description	3/605 4/606	10/612 10BL/614	Stock PC 10BE	26/625 26D/626	15/619
570	Dust Proof Strike	Refer to Accessories Price Book for Pricing				
Part	Description	3/605 4/606	10/612 10BL/614	Stock PC 10BE	26/625 26D/626	32D/630
RM850	Floor Mounted Stop 1 1/2" Projection	41	45	43	38	37
RM851	Floor Mounted Stop 2 1/2" Projection	52	57	55	52	48
Part	Description	3/605 4/606	Stock PC 10BE	32D/630		
ADA (suffix)	ADA Large Thumbturn - 1 13/16" Projection	41	40.40	39.30		

NOTE: Thumbturn design differs between the round and square versions.

Architectural Finishes

Most of Rockwood's products are available in all of the following architectural finishes. The catalog indicates exceptions. This finish list is grouped by base metal.

Base Metal	Description	Price Book Code	Rockwood Code	BHMA Code
Aluminum	Satin	27	US27	627
Aluminum	Clear Anodized	28	US28	628
Aluminum	Light Bronze Anodized	311	311	—
Aluminum	Medium Bronze Anodized	312	312	—
Aluminum	Dark Bronze Anodized	313	313	710
Aluminum	Extra Dark Bronze Anodized	314	314	—
Aluminum	Black Anodized	315	315	711
Aluminum	White Powder Coat	WPC	WPC	—
Aluminum	Red Powder Coat	RPC	RPC	—
Aluminum	Black Powder Coat	BPC	BPC	—
Brass	Polished Clear Coated	3	US3	605
Brass	Polished No Coating	3NL	US3NL	—
Brass	Satin Clear Coated	4	US4	606
Brass	Satin Oxidized Relieved	5	US5	609
Brass	Satin Nickel Plated Clear Coated	15	US15	619
Brass	Satin Nickel Blackened Relieved Clear Coated	15A	US15A	620
Brass	Flat Black Powder Coated	19	US19	622
Brass	Polished Chrome Plated	26	US26	625
Brass	Satin Chrome Plated	26D	US26D	626
Bronze*	Polished Clear Coated	9	US9	611
Bronze*	Satin Clear Coated	10	US10	612
Bronze*	Satin Black Oxidized Oil Rubbed	10A	US10A	722
Bronze*	Satin Oxidized Oil Rubbed	10B	US10B	613
Bronze*	Satin Oxidized Clear Coated	10BL	US10BL	614
Bronze*	Dark Oxidized Statuary Clear Coated	20A	US20A	624
Stainless Steel	Polished	32	US32	629
Stainless Steel	Satin	32D	US32D	630
Special Finishes (see descriptions)				
Stainless Steel	Satin MicroShield® Coated	32DMS***	US32DMS***	—
Stainless Steel	Polished 316 Alloy	32316***	US32316***	—
Stainless Steel	Satin 316 Alloy	32D316***	US32D316***	—
	Dark Oxidized Satin Bronze, Equivalent	10BE	US10BE	(613E)
	Black Suede Powder Coat	BSP	BSP	—
	White Suede Powder Coat	WSP	WSP	—
	Wrought Black Powder Coat	WB	WB	—

Special Finishes Description

32DMS (MicroShield®): As part of its promise to provide innovative solutions to their customers, ASSA ABLOY Group companies offer the MicroShield® technology, a silver-based antimicrobial coating designed to inhibit the spread of germs and bacteria.

32316 and **32D316** are made from alloy 316 stainless steel containing molybdenum and extra nickel giving it substantially higher corrosion resistance than the standard stainless steels typically used in door hardware. This finish is ideal for use in coastal, urban, and industrial areas that have harsh environmental conditions. **32316** (polish) finishes offer the best corrosion resistance and should be used in caustic environments.

10BE Dark Oxidized Satin Bronze equivalent: This finish provides the richness and warmth of the 10B/613 "living" finish, but maintains its original color and appearance and will not fade or wear over time. The 10BE finish is offered by Corbin Russwin, McKinney, Norton, Rixson, Rockwood, SARGENT and Yale, providing visual consistency between ASSA ABLOY Group brands.

* On most bronze finishes we will supply solid bronze material. Where solid bronze material is not available, we will use brass as a base material with a bronze look powder coat in its place.

*** Available on select items as indicated by the finish icon throughout the catalog.

Wood Finishes

Wood Species and Finishes are found on page 39.



MicroShield® is a registered trademark of Yale Security Inc., an ASSA ABLOY Group company.

Mounting Types

PULL STYLE	PULL ON ONE SIDE OF DOOR						PULL ON BOTH SIDES OF DOOR (BTB)			
	Thru Bolt	Deco Thru Bolt		Concealed			Conehead/Set Screw		Spanner Collar	
DOOR TYPE	Wood/Metal		Glass	Metal	Metal	Wood	Wood/Metal	Glass	Wood/Metal	Glass
CONEHEADS	NA	NA	NA	Single	Single	Single	Single	Single	NA	NA
MOUNTING TYPE	Type 1	Type 12	Type 15	Type 6	Type 6R	Type 8	Type 5	Type 13	Type 11	Type 14
Standard (STD) Bolt Size	¼"-20	¼"-20	¼"-20	¼"-20	¼"-20	¼"-20	¼"-20	¼"-20		
Price	INCL	27.76	32.80	8.24	13.00	10.80	8.24	15.19		
Heavy Duty (HD) Bolt Size	⅝"-18	⅝"-18	⅝"-18	⅝"-18	⅝"-18	⅝"-18	⅝"-18	⅝"-18		
Price	8.24	32.80	38.86	12.28	18.40	15.10	12.28	19.23		
Extra Heavy Duty (XHD) Bolt Size	¾"-16	¾"-16	¾"-16						¾"-16	¾"-16
Price	12.06	35.83	41.89						31.29	37.34

Straight Pulls											
Pull Type	Dia.	MAXIMUM BOLT SIZE ALLOWED						MAXIMUM BOLT SIZE ALLOWED			
		Type 1	Type 12	Type 15	Type 6	Type 6R	Type 8	Type 5	Type 13	Type 11	Type 14
Straight	½"	STD	STD	STD			STD		STD	STD	STD
Straight	⅝"	HD	HD	HD	STD		STD	STD	STD		
Straight	1"	HD	HD	HD	HD	HD	HD	HD	HD	HD	HD
Straight	1 ¼"	HD	HD	HD	HD	HD	HD	HD	HD	HD	HD
Straight	1 ½"	HD	HD	HD	HD	HD	HD	HD	HD	HD	HD

Offset Pulls											
Pull Type	Dia.	MAXIMUM BOLT SIZE ALLOWED						MAXIMUM BOLT SIZE ALLOWED			
		Type 1	Type 12	Type 15	Type 6	Type 6R	Type 8	Type 5	Type 13	Type 11	Type 14
Offset	½"	STD	STD	STD						STD	STD
Offset	⅝"	HD	HD	HD						STD	STD
Offset	1"	XHD	XHD	XHD						HD	HD
Offset	1 ¼"	XHD	XHD	XHD						HD	HD
Offset	1 ½"	XHD	XHD	XHD						HD	HD

Door Pull Mounting Details

Free End Thru Bolt

TYPE 1 - Thru Bolt Wood or Metal Door

Type	Bolt Size	Drill Size	Price
1	1/4"-20	9/32	Incl.
1HD	5/16"-18	11/32	8.24
1XHHD	3/8"-16	13/32	12.06

TYPE 12 - Decorative Thru Bolt Wood or Metal Door

Type	Bolt Size	Drill Size	Price
12	1/4"-20	9/32	27.76
12HD	5/16"-18	11/32	32.80
12XHHD	3/8"-16	13/32	35.83

TYPE 15 - Decorative Thru Bolt Glass Door

Type	Bolt Size	Drill Size	Price
15	1/4"-20	5/8	32.80
15HD	5/16"-18	5/8	38.86
15XHHD	3/8"-16	5/8	41.89

Free End Concealed

TYPE 6 - Surface Concealed Metal Door

Minimum diameter of pull is 5/8"

Type	Bolt Size	Drill Size	Price
6	1/4"-20	1/4"-20 Tap	8.24
*6HD	5/16"-18	5/16"-18 Tap	12.28

TYPE 6R - Surface Concealed Metal Door

Minimum diameter of pull is 1"

Type	Bolt Size	Drill Size	Price
6	1/4"-20	N/A	13.00
*6HD	5/16"-18	N/A	18.40

TYPE 8 - Surface Concealed Wood Door

Type	Bolt Size	Drill Size	Price
8	1/4"-20	23/64"-9/16 dp.	10.80
*8HD	5/16"-18	7/16"-9/16 dp.	15.10

Back-to-Back

TYPE 5 - Back-to-Back Wood or Metal Door

Minimum diameter of pull is 5/8"

Type	Bolt Size	Drill Size	Price
5	1/4"-20	9/32	8.24
5HD	5/16"-18	11/32	12.28

TYPE 13 - Back-to-Back Glass Door

Type	Bolt Size	Drill Size	Price
13	1/4"-20	5/8	15.19
*13HD	5/16"-18	5/8	19.23

TYPE 11XHHD - Back-to-Back w/Spanner Collar - Wood or Metal Door

Minimum diameter of pull is 1"

Type	Bolt Size	Drill Size	Price
11XHHD	3/8"-16	13/32	31.29

TYPE 14XHHD - Back-to-Back Glass Door

Minimum diameter of pull is 1"

Type	Bolt Size	Drill Size	Price
14XHHD	3/8"-16	5/8	37.34

*HD mountings feature 2 set screws 180° apart.

RM4800 Mounting Only

RM4800 Series - Thru Bolt Wood or Metal Door

Bolt Size	Drill Size	Price
3/8"-16	5/8	41.10

RM4800 Series - Back-to-Back Wood or Metal Door

Bolt Size	Drill Size	Price
3/8"-16	5/8	41.10

Push and Pull Bar Mounting Details

Sizing of Push Bars

Flush Doors

- Door width:
- minus 5" for bent end bars
 - minus 5" for flat end post mount bars
 - minus 7" for round end post mount bars

Stile and Rail Doors or Doors with Lites

- Door width:
- minus width of one stile

CAUTION: Always confirm bars will not interfere with jamb or cause pinching hazard.

CAUTION: On narrow stile doors, be sure push bar base fits on the stile and bar does not interfere with the stop.

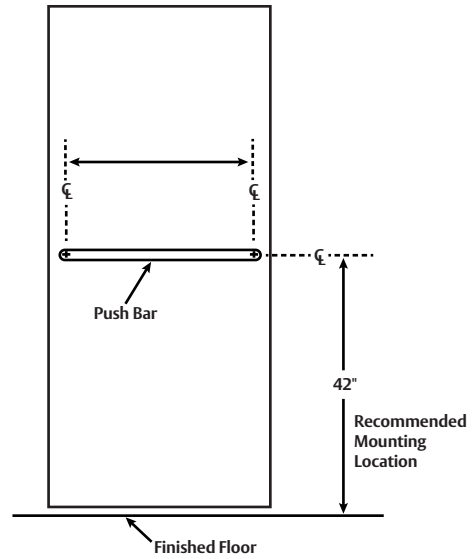

Handing of Doors

The handing of a door is determined from the outside of the opening.

Standing outside the door:

- If the hinges are on the right, it is a right hand door.
- If the hinges are on the left, it is a left hand door.
- If the door opens away from you, it is a regular bevel door.
- If the door opens toward you, it is a reverse bevel door.

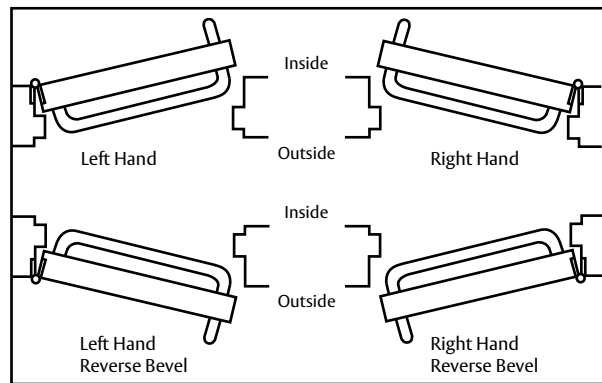

Typical Mounting

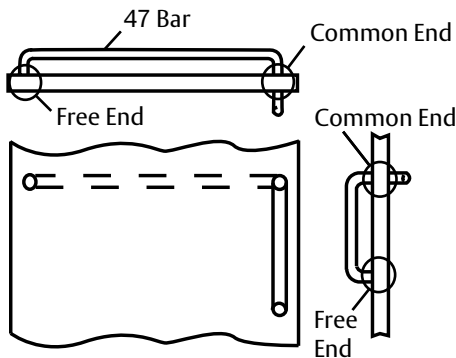

Thru Bolt Mounting - for 1 3/4" Wood and Metal Doors

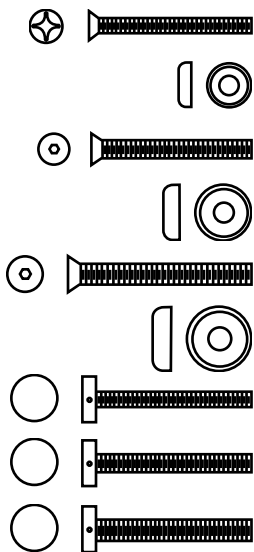

Part	Description	Mounting Type	Price
SP1004	1/4"-20 x 2 1/4" Flat Head Machine Screw Thru Bolt	1	1.22
SP1005	1/4"-20 Finishing Washer	1	.86
SP1053	5/16"-18 x 2 1/2" Socket Flat Head Machine Screw Thru Bolt	1HD	3.33
SP1054	5/16"-18 Finishing Washer	1HD	1.23
SP1001	3/8"-16 x 2 1/2" Socket Flat Head Machine Screw Thru Bolt	1XHD	5.16
SP1002	3/8"-16 Finishing Washer	1XHD	1.54
SP1003	1" Diameter Decorative Thru Bolt 1/4"-20 x 2 1/4"	12	13.95
SP1055	1" Diameter Decorative Thru Bolt 5/16"-18 x 2 1/4"	12HD	16.62
SP1041	1 1/4" Diameter Decorative Thru Bolt 3/8"-16 x 2 1/4"	12XHD	16.62

Back to Back Mounting - for 1 3/4" Wood and Metal Doors

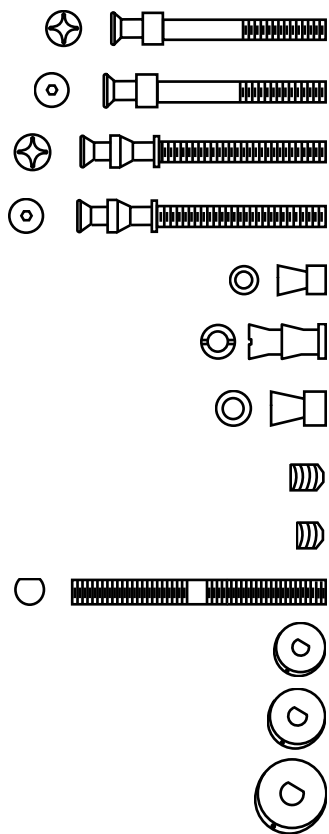

Part	Description	Mounting Type	Price
SP1025	1/4"-20 x 2 1/4" Cone Head Machine Screw	5	3.62
SP1056	5/16"-18 x 2 1/4" Cone Head Machine Screw	5HD	5.73
SP1052	1/4"-20 x 2 1/4" Double Cone Head Machine Screw (for use with offset pulls)	16	4.29
SP1057	5/16"-18 x 2 1/4" Double Cone Head Machine Screw (for use with offset pulls)	16HD	7.05
SP1027	1/4"-20 Cone Head Union (Used to Convert Cone Head to Thru Bolt Hole)	N/A	3.62
SP1079	1/4"-20 Double Cone Head Union (Used to Convert Double Cone Head to Thru Bolt Hole)	N/A	6.39
SP1068	5/16"-18 Cone Head Union (Used to Convert Cone Head to Thru Bolt Hole)	N/A	5.73
SP1026	1/4"-20 x 5/16" Set Screws (Standard)	N/A	.86
SP1065	1/4"-20 x 3/16" Set Screw (Short)	N/A	1.13
SP1032	3/8"-16 x 3 1/2" LH/RH Bolt	11	7.56
SP1071	Spanner Collar 1" Diameter for LH/RH Bolt	11	11.44
SP1033	Spanner Collar 1 1/4" Diameter for LH/RH Bolt	11	11.44
SP1072	Spanner Collar 1 1/2" Diameter for LH/RH Bolt	11	12.73

Concealed Mounting - for 1 3/4" Wood and Metal Doors

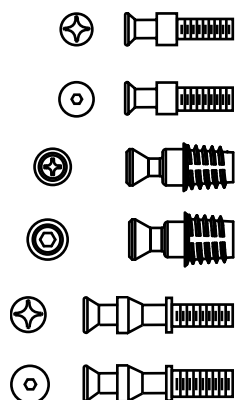

Part	Description	Mounting Type	Price
SP1039	1/4"-20 x 1/2" Cone Head Machine Screw	6 / 6R	3.62
SP1058	5/16"-18 x 1/2" Cone Head Machine Screw	6HD	5.73
SP1080	1/4"-20 Cone Head / Knife Thread Insert	8	6.03
SP1082	5/16"-18 Cone Head / Knife Thread Insert	8HD	6.03
SP1051	1/4"-20 x 1/2" Double Cone Head Machine Screw	17 / 17R	5.73
SP1059	5/16"-18 x 1/2" Double Cone Head Machine Screw	17HD	7.05

Bushings & Washers - for 1/2" Glass Doors

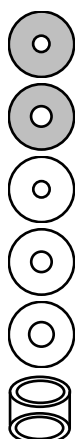

Part	Description	Mounting Type	Price
SP1022	Stainless Steel Washer for 1/4"-20 Cone Head Machine Screw .032" Thick	13	1.54
SP1060	Stainless Steel Washer for 5/16"-18 Cone Head Machine Screw .060" Thick	13HD	1.54
SP1023	Plastic Washer for 1/4"-20 Bolt; Specify Size	13	1.33
SP1061	Plastic Washer for 5/16"-18 Bolt; Specify Size	13HD	1.43
SP1062	Plastic Washer for 3/8"-16 Bolt; Specify Size	14	1.43
SP1024	Glass Door Bushing for 5/8" Hole in Glass; Specify Size	13 / 13HD / 14	1.54

Thru Bolt Mounting - for 1/2" Glass Doors

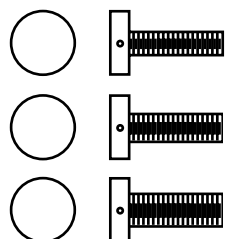

Part	Description	Mounting Type	Price
SP1020	1" Diameter Decorative Thru Bolt; 1/4"-20 x 1 1/8"	15	13.95
SP1063	1" Diameter Decorative Thru Bolt; 5/16"-18 x 1 1/8"	15HD	16.62
SP1040	1 1/4" Diameter Decorative Thru Bolt; 3/8"-16 x 1 1/8"	15XHD	16.62

Back to Back Mounting - for 1/2" Glass Doors

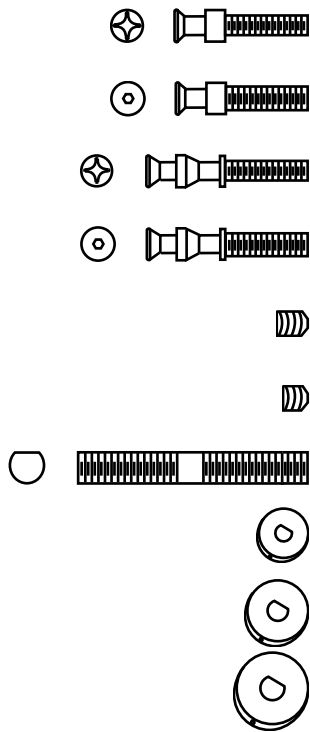

Part	Description	Mounting Type	Price
SP1021	1/4"-20 x 1 1/8" Cone Head Machine Screw	13	3.62
SP1064	5/16"-18 x 1 1/8" Cone Head Machine Screw	13HD	5.73
SP1067	1/4"-20 x 1 1/8" Double Cone Head Machine Screw	18	5.73
SP1066	5/16"-18 x 1 1/8" Double Cone Head Machine Screw	18HD	7.05
SP1026	1/4"-20 x 5/16" Set Screw (Standard)	N/A	.86
SP1065	1/4"-20 x 3/16" Set Screw (Short)	N/A	1.13
SP1031	3/8"-16 x 1 3/4" LH/RH Bolt	14	7.56
SP1071	Spanner Collar 1" Diameter for LH/RH Bolt	14	11.44
SP1033	Spanner Collar 1 1/4" Diameter for LH/RH Bolt	14	11.44
SP1072	Spanner Collar 1 1/2" Diameter for LH/RH Bolt	14	12.73

Y Base Plates

Specify bolt hole size and finish. Standard pulls require two plates.

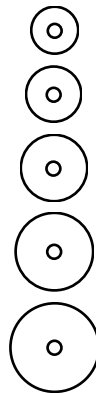

Part	Description	For Use With	Price
SP1073	1/8" Thick x 1 1/16" Diameter	3/4" Diameter Pulls	13.95
SP1074	1/8" Thick x 1 1/4" Diameter	1" Diameter Pulls and Posts	13.95
SP1075	1/8" Thick x 1 1/2" Diameter	1" Diameter Pulls and Posts	13.95
SP1076	1/8" Thick x 1 3/4" Diameter	1" Diameter Pulls and Posts	13.95
SP1077	1/8" Thick x 2" Diameter	1" Diameter Pulls and Posts	13.95

Flush Pull Fasteners

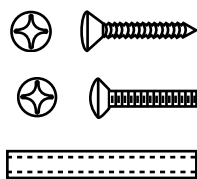

Part	Description	Door Type	Price
SP1006	#8 x 3/4" Oval Head Sheet Metal Screw	Wood or Metal	.66
SP1007	#8-32 x 3/4" Oval Head Machine Screw	Metal	.66
SP1034	#8-32 x 1 5/8" Brass Sleeve Machine Screw	Wood or Metal	3.84

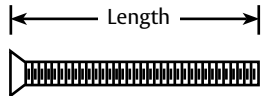

Standard Thru Bolt for Countersunk Holes

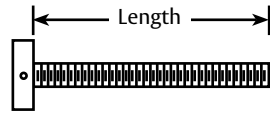

Decorative Thru Bolt for Wood or Metal Doors

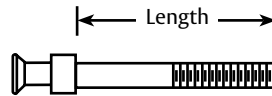

Cone Head Bolt for Back-to-Back Wood or Metal Doors

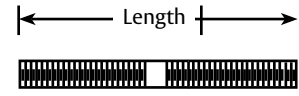

LH/RH Bolt without Heads

Mounting Kits for Door Pulls

Part	Mounting Type	Description	Price
KIT1	1	2 ea. 1/4"-20 x 2 1/4" Thru Bolts and 2 ea. Finish Washers; Specify Finish	4.13
KIT1HD	1HD	2 ea. 5/16"-18 x 2 1/2" Thru Bolts and 2 ea. Finish Washers; Specify Finish	8.24
KIT1XHD	1XHD	2 ea. 3/8"-16 x 2 1/2" Thru Bolts and 2 ea. Finish Washers; Specify Finish	12.06
KIT5	5	2 ea. 1/4"-20 x 2 1/4" Cone Head Bolts and 4 ea. Set Screws	8.24
KIT5HD	5HD	2 ea. 5/16"-18 x 2 1/4" Cone Head Bolts and 4 ea. Set Screws	12.28
KIT6	6	2 ea. 1/4"-20 x 1/2" Cone Head Bolts and 4 ea. Set Screws	8.24
KIT6HD	6HD	2 ea. 5/16"-18 x 1/2" Cone Head Bolts and 4 ea. Set Screws	12.28
KIT11	11	2 ea. 3/8"-16 x 3 1/2" LH/RH Bolt and 2 ea. Spanner Collars for 1 3/4" Doors; Specify Pull Diameter and Finish	31.29
KIT12-1	12	2 ea. 1/4"-20 x 2 1/4" Decorative Thru Bolts; 1" Dia.; Specify Finish	27.76
KIT12-1HD	12HD	2 ea. 5/16"-18 x 2 1/4" Decorative Thru Bolts; 1" Dia.; Specify Finish	32.8
KIT12-1.25XHD	12XHD	2 ea. 3/8"-16 x 2 1/4" Decorative Thru Bolts; 1 1/4" Dia.; Specify Finish	35.83
KIT13	13	2 ea. 1/4"-20 x 1 1/8" Cone Head Bolts; 2 ea. Metal Washers; 4 ea. Plastic Washers; 2 ea. Bushings for 1/2" Glass Doors; 4 ea. Set Screws; Specify if other than 1/2" Glass	15.19
KIT13HD	13HD	2 ea. 5/16"-18 x 1 1/8" Cone Head Bolts; 2 ea. Metal Washers; 4 ea. Plastic Washers; 2 ea. Bushings for 1/2" Glass Doors; 4 ea. Set Screws; Specify if other than 1/2" Glass	19.23
KIT14	14	2 ea. 3/8"-16 x 2 1/4" LH/RH Bolt; 2 ea. Spanner Collars; 2 ea. Bushings; 4 ea. Washers for 1/2" Glass Doors; Specify Pull Diameter and Finish	37.34
KIT15	15	2 ea. 1/4"-20 x 1 1/8" Decorative Thru Bolts; 1" Dia.; 2 ea. Bushings; 4 ea. Plastic Washers; Specify Finish and Glass Thickness/Hole Size	32.8
KIT15HD	15HD	2 ea. 5/16"-18 x 1 1/8" Decorative Thru Bolts; 1" Dia.; 2 ea. Bushings; 4 ea. Plastic Washers; Specify Finish and Glass Thickness/Hole Size	38.86
KIT15-1.25XHD	15XHD	2 ea. 3/8"-16 x 1 1/8" Decorative Thru Bolts; 1 1/4" Dia.; 2 ea. Bushings; 4 ea. Plastic Washers; Specify Finish and Glass Thickness/Hole Size	41.89
KIT15-1.5XHD	15XHD	2 ea. 3/8"-16 x 1 1/8" Decorative Thru Bolts; 1 1/2" Dia.; 2 ea. Bushings; 4 ea. Plastic Washers; Specify Finish and Glass Thickness/Hole Size	47.93
KIT16	16	2 ea. 1/4"-20 x 2 1/4" Double Cone Head Bolts and 4 ea. Set Screws	12.28
KIT16HD	16HD	2 ea. 5/16"-18 x 2 1/4" Double Cone Head Bolts and 4 ea. Set Screws	15.19

Part	Mounting Type	Description	Price
KIT17	17	2 ea. 1/4"-20 x 1/2" Double Cone Head Bolts and 4 ea. Set Screws	12.28
KIT17HD	17HD	2 ea. 5/16"-18 x 1/2" Double Cone Head Bolts and 4 ea. Set Screws	15.19
KIT18	18	2 ea. 1/4"-20 x 1 1/8" Double Cone Head Bolts; 2 ea. Metal Washers; 4 ea. Plastic Washers; 2 ea. Bushings for 1/2" Glass Doors; Specify if other than 1/2" Glass and 4 ea. Set Screws	21.04
KIT18HD	18HD	2 ea. 5/16"-18 x 1 1/8" Double Cone Head Bolts; 2 ea. Metal Washers; 4 ea. Plastic Washers; 2 ea. Bushings for 1/2" Glass Doors; Specify if other than 1/2" Glass and 4 ea. Set Screws	24.06
KIT-T1	T1	1 ea. 1/4"-20 X 2 1/4" Cone Head Bolt; 1 ea. 1/4"-20 Cone Head Union; 2 ea. Set Screws; 2 ea. 1/4"-20 x 2 1/4" — 1" Dia. Decorative Thru Bolts; Specify Finish	35.82
KIT-T2	T2	1 ea. 1/4"-20 X 1 1/8" Cone Head Bolt; 1 ea. 1/4"-20 Cone Head Union; 2 ea. Set Screws; 2 ea. 1/4"-20 x 1 1/8" — 1" Dia. Decorative Thru Bolts; 1 ea. Metal Washer; 6 ea. Plastic Washers; 3 ea. Bushings; Specify Finish	44.91
KIT-T3	T3	1 ea. 1/4"-20 X 2 1/4" Cone Head Bolt; 1 ea. 1/4"-20 Cone Head Union; 2 ea. Set Screws; 2 ea. 1/4"-20 x 2 1/4" Thru Bolts; 2 ea. Finish Washers; Specify Finish	12.26
KIT-T4	T4	1 ea. 1/4"-20 X 2 1/4" Cone Head Bolt; 2 ea. 1/4"-20 x 1/2" Cone Head Bolts; 3 ea. Set Screws	12.26
KIT-T5	T5	1 ea. 1/4"-20 X 2 1/4" Cone Head Bolt; 2 ea. 1/4"-20 x 1/2" Cone Head Wood Screws; 3 ea. Set Screws	12.26
KITRM1.25	11x1XHD	2 ea. 3/8"-16 x 2 1/2" Thru-Bolts; 2 ea. Finish Washers; 1 ea. 3/8"-16 x 3 1/2" LH/RH Bolt; 1 ea. 1 1/4" Spanner Collar; Specify Finish	27.76
KITRM360	11x12XHD	2 ea. 3/8"-16 x 2 1/4" Decorative Thru Bolts 1 1/4" Dia.; 1 ea. 3/8"-16 x 3 1/2" LH/RH Bolt; 1 ea. 1 1/4" Spanner Collar; Specify Finish	51.47
KITRM360G	14x15XHD	2 ea. 3/8"-16 x 2 1/4" Decorative Thru Bolts 1 1/4" Dia.; 1 ea. 3/8"-16 x 2 1/4" LH/RH Bolt; 1 ea. 1 1/4" Spanner Collar; 3 ea. Bushings; 6 ea. Plastic Washers; Specify Finish	60.56
KITRM1.5	11x1XHD	2 ea. 3/8"-16 x 2 1/2" Thru Bolts; 2 ea. Finish Washers; 1 ea. 3/8"-16 x 3 1/2" LH/RH Bolt; 1 ea. 1 1/2" Spanner Collar; Specify Finish	30.78
KITRM380	11x12XHD	2 ea. 3/8"-16 x 2 1/4" Decorative Thru Bolts 1 1/2" Dia.; 1 ea. 3/8"-16 x 3 1/2" LH/RH Bolt; 1 ea. 1 1/2" Spanner Collar; Specify Finish	60.56
KITRM380G	14x15XHD	2 ea. 3/8"-16 x 2 1/4" Decorative Thru Bolts 1 1/2" Dia.; 1 ea. 3/8"-16 x 1 1/4" LH/RH Bolt; 1 ea. 1 1/2" Spanner Collar; 3 ea. Bushings; 6 ea. Plastic Washers; Specify Finish	69.64

Discontinued Products

Coat Hooks
RM809
RM810
RM824
RM825
RM826
RM827

RM3100 MegaTek Series - See RM3300 MegaTek Series on pg. 18 for equivalent pulls.	
Discontinued Part #	Equivalent Part #
RM3100	RM3300
RM3110	RM3301
RM3120	RM3302
RM3130	RM3310
RM3140	RM3311
RM3150	RM3312
RM3104	RM3320
RM3114	RM3321
RM3124	RM3322
RM3134	RM3330
RM3144	RM3331
RM3154	RM3332

RM3200 NeoTek Series - See RM3400 NeoMax Series on pg. 21 for equivalent pulls.	
Discontinued Part #	Equivalent Part #
RM3200	RM3400
RM3210	RM3401
RM3220	RM3402
RM3230	RM3410
RM3240	RM3411
RM3250	RM3412
RM3204	RM3420
RM3214	RM3421
RM3224	RM3422
RM3234	RM3430
RM3244	RM3431
RM3254	RM3432

Partial RM3500 LineaMet Series - See LineaMax Series on pg. 23 for equivalent pulls	
Discontinued Part #	Equivalent Part #
RM3510	RM3701
RM3520	RM3702
RM3540	RM3711
RM3550	RM3712
RM3514	RM3751
RM3524	RM3752
RM3544	RM3761
RM3554	RM3762

Partial RM3600 LineaTek Series - See LineaMax Series on pg. 24 for equivalent pulls	
Discontinued Part #	Equivalent Part #
RM3610	RM3721
RM3620	RM3722
RM3640	RM3731
RM3650	RM3732
RM3614	RM3771
RM3624	RM3772
RM3644	RM3781
RM3654	RM3782

Discontinued Products (con't)

CenTrex - Large Radius Pulls	
RM4550	
RM4552	

SculpTrex - Shaped Cast Pulls	
RM5000	
RM5002	
RM5010	
RM5012	
RM5020LH	
RM5020RH	
RM5030	
RM5032	
RM5040	
RM5042	
RM5050LH	
RM5050RH	

Classic - Finial Door Pulls	
RM5600	
RM5602	
RM5604	
RM5610	
RM5612	
RM5614	

Partial RM6000 English Bridle Leather Series - See English Bridle Leather series on pg. 42 for equivalent pulls	
Discontinued Part #	Equivalent Part #
RM6000	RM6060
RM6010	RM6061
RM6020	RM6062
RM6030	RM6070
RM6040	RM6071
RM6050	RM6072
RM6004	RM6080
RM6014	RM6081
RM6024	RM6082
RM6034	RM6090
RM6044	RM6091
RM6054	RM6092

Partial RM6100 Upholstery Leather Series - See Upholstery Leather series on pg. 44 for equivalent pulls	
Discontinued Part #	Equivalent Part #
RM6100	RM6160
RM6110	RM6161
RM6120	RM6162
RM6130	RM6170
RM6140	RM6171
RM6150	RM6172
RM6104	RM6180
RM6114	RM6181
RM6124	RM6182
RM6134	RM6190
RM6144	RM6191
RM6154	RM6192

Notes

Notes

ASSA ABLOY is the global leader in door opening solutions, dedicated to satisfying end-user needs for security, safety and convenience

ASSA ABLOY
Opening Solutions



300 Main Street
Rockwood, Pennsylvania 15557
P: 800-458-2424 • F: 800-922-9212
www.assaabloydooraccessories.us
orders.rockwood@assaabloy.com

(In Canada)
Door Security Solutions Canada
160 Four Valley Drive
Vaughan, ON L4K 4T9
P: 800-461-3007
www.assaabloydss.ca