

SARGENT®

ASSA ABLOY

11 Line

Bored Lock



Table of Contents

11 Line Bored Lock

Features, Benefits and Applications	1
Windstorm Certifications	2
STC Acoustic Door Systems	3
Functions	4-5
Function Conversion Chart and Retrofit Options	6
Lever and Rose Designs	7
Latches and Strikes	8
Mechanical and Cylinder Options	9-10
Cylinder Options	10
How to Order, Packaging, Finishes and Architectural Specifications	11

Specifications

For Doors	1-3/4" to 2" (44mm to 51mm) thick doors standard Special order for doors over 2" thick, consult factory for lead time & pricing Not available for 1-3/8" (35mm) thick doors
Backsets	2-3/4" (70mm) standard 3-3/4" (95mm) backset available (23- option) 5" (127mm) backset available (25- option)
Bearing Assembly	Cast and machined stainless steel
Front	Wrought brass, bronze or stainless steel 2-1/4" x 1-1/8" (57mm x 29mm) Self-adjusting for flat to 1/8" (3mm) in 2" (51mm) bevel
Strike	Wrought brass, bronze or stainless steel 800 curved lip strike standard 808 ANSI curved lip strike available (28- option) Wrought box strike available (WBS- option)
Hand	Universal, not handed
Levers	Secured with 6 lobe security set screw standard 6 Lobe tool packed with each lock
Roses	Heavy wrought brass, bronze or stainless steel
Latchbolt	Stainless steel bolt 7/8" (22mm) dia. x 1/2" (13mm) throw 3/4" (19mm) throw for pairs of doors (41- option)
Cylinder	Brass, 6-Pin, LA keyway standard
Keys	Two, nickel silver
Masterkeying	Can be masterkeyed or grand masterkeyed Construction key systems available
Finishes	03, 04, 09, 10, 10B, 10BE, 10BL, 14, 15, 20D, 26, 26D
Door Prep	ANSI A115.2 (161)
Minimum Stile	4-1/4" (108mm) with B and O roses 4-1/2" (114mm) with E and L roses

Certification Compliance

ANSI	Meets and greatly exceeds ANSI A156.2 Series 4000 - Grade 1
UL	UL and cUL listed to Canadian safety standards Listed for 3 Hour Doors (double doors require 41- option)
Positive Pressure	Meets ANSI/UL 10C, Positive Pressure Fire Test of Door Assemblies
ADA	All levers conform to ADA requirements for barrier-free accessibility. Levers (L, J and P) conform to California Administrative Code Title 19
Windstorm Certifications	UL Listed: ANSI/SDI-BHMA A250.13; ANSI/ASTM E330-2002; ANSI/ASTM E1886-2005 & ASTM E1996-2009 UL Certification Directory ZHEM.R21744 Latching Hardware Listed on Florida Building Code Website: FL4351-R1

Any retrofit or other field modification to a fire rated opening can potentially impact the fire rating of the opening, and Sargent Manufacturing Company makes no representations or warranties concerning what such impact may be in any specific situation. When retrofitting any portion of an existing fire rated opening, or specifying and installing a new fire-rated opening, please consult with a code specialist or local code official (Authority Having Jurisdiction) to ensure compliance with all applicable codes and ratings.

On the Cover

11G05 x OL x 26D Entrance Lock

1-800-727-5477 • www.sargentlock.com

SARGENT®

ASSA ABLOY

Hardwiring Made Easy™



As part of their promise to provide innovative, fast and effective high security solutions to their customers, certain ASSA ABLOY Group brands offer ElectroLynx®, a universal quick-connect system that simplifies the electrification of the door opening.

ElectroLynx® is a registered trademark of ASSA ABLOY Inc.



MicroShield®

As part of their promise to provide innovative solutions to their customers, certain ASSA ABLOY Group brands offer the MicroShield® technology, a silver-based antimicrobial coating designed to inhibit the growth of bacteria. MicroShield® is a registered trademark of Yale Security Inc., an ASSA ABLOY Group company.

MicroShield® Coating

- Revolutionary finish coating available on all SARGENT product lines, utilizes a silver-based antimicrobial compound from Agion Technologies
- As an integral part of the finish coating, MicroShield® lasts for the life of the hardware
- MicroShield® coating permanently suppresses the growth of bacteria, algae, fungus, mold and mildew. It is effective against a broad spectrum of bacteria.
- Non-toxic and completely safe. The Agion antimicrobial compound is EPA and NSF approved and FDA listed for use in medical and food preparation equipment.
- Applications: Anywhere there is need for a clean environment (hospitals, laboratories, schools, medical centers, daycare, food processing etc.)



Agion has achieved:

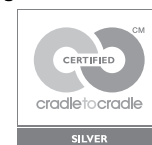

Agion's silver antimicrobial has been certified for its material content, recyclability, and manufacturing characteristics. Cradle To Cradle Certified^{CM} products meet established standards for human health, environmental health and recyclability.

Cradle To Cradle Certified^{CM} is a certification mark of MBDC.

ASSA ABLOY, the global leader in door opening solutions

Features, Benefits and Applications

11 Line Bored Lock

SARGENT®
ASSA ABLOY

The SARGENT 11 Line* sets a higher standard for Grade 1 bored-in locks. The unique, T-Zone construction provides unequalled strength and durability for the most demanding applications such as schools and hospitals. This is accomplished by true interlocking between the lockbody and the latchbolt.

Specify the SARGENT 11 Line when you need the ultimate in strength and durability in a bored-in lock. Accept no substitute. There is no equal!

*U.S. Patent No. 6,626,018

T-Zone Construction — There is no equal!

Direct linkage with fixed alignment between the hub and the latchbolt is the best construction for quietly and effectively operating the latchbolt. For this reason, SARGENT has developed the interlocking aligning and latch tubes, which form a rugged torque resistant "T" in the critical twist area. This "T-Zone" construction, combined with long lasting components, makes 11 Line bored locks outstanding!

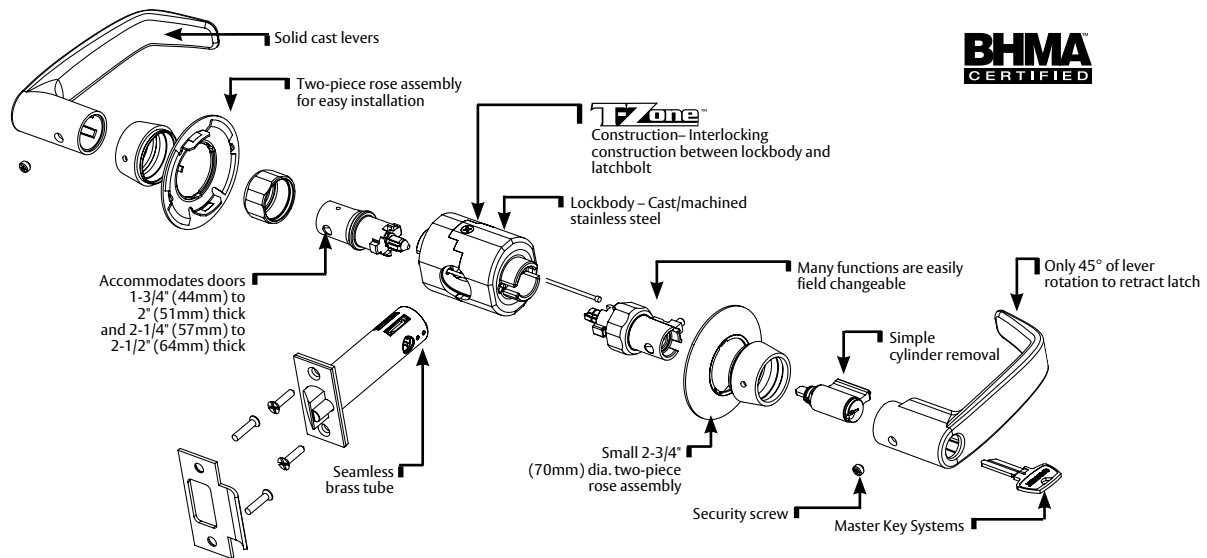

BHMA
CERTIFIED

Maximum Strength & Durability

- True interlocking between the cast/ machined stainless steel lockbody and latchbolt. Provides unequalled strength and durability
- Independent Testing proves:
 - Exceeds 15 TIMES ANSI/ BHMA A156.2 Grade 1 standard for cycle testing. Over 15,000,000 MILLION cycles!
 - Withstands 3 TIMES ANSI/ BHMA A156.2 Grade 1 torque force on a locked lever. Over 3000 in/lbs!
 - Virtually no lever sag ever
- In a class of its own! This lock raises the bar and sets new standards!
- 10 Year limited warranty. No service required to maintain warranty

BHMA
CERTIFIED

Maximum Convenience

- Two-piece rose assembly goes quickly into place
- "Out of the box and onto the door" packaging organizes the parts, has simple instructions and even a small tool kit
- Fits any 161 prep; Does not fit 160 door prep
- Two piece rose & collar for easier installation
- Only 45° of lever rotation required to retract latchbolt
- 18 functions. Many functions are easily field changeable
- 4 ADA lever designs and 4 roses available to cover a wide variety of door preps and design requirements
- Simple cylinder removal. Easy change outs
- 11 Architectural grade finishes
- SARGENT uses engineered solutions and flexible manufacturing processes to accommodate special applications

Security

- The only bored lock on the market available with security lever catch feature for high vandalism application
- Resists vandalism
- Torx® and spanner screws
- Classroom security function available
- Security key systems available (Signature, Keso F1, XC)

Applications

- High traffic areas – offices, public buildings, hospitals
- High abuse areas – institutions, schools, retail
- Anywhere that requires the contemporary look of a small rose and durability that exceeds Grade 1 standards

Innovation

- Patented "11 Line" construction with true interlocking between the lockbody and the latchbolt Provides unequalled strength and durability for the most demanding applications
- Revolutionary MicroShield® available, technology, containing the Agion™ antimicrobial compound, that suppresses the growth of destructive bacteria

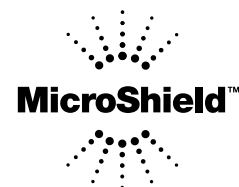

Windstorm Certifications

11 Line Bored Lock

SARGENT®

ASSA ABLOY

Windstorm Certifications: Florida Building Codes & UL Listings

SARGENT's products meet building codes that require hurricane, windstorm and FEMA certifications, including some of the most stringent building codes as specified in the Florida Building Code, Miami Dade Code and the International Building Code. Listed below are certifications and standards met by the 11 Line lock.

Florida Building Code: FL2998

UL Certification Directory: ZHEM.R21744 – Latching Hardware

ANSI/SDI-BHMA A250.13	"Testing and Rating of Severe Windstorm Resistant Components for Swinging Door Assemblies"
ANSI/ASTM E330	"Standard Test Method for Structural Performance of Exterior Windows, Doors, Skylights and Curtain Walls by Uniform Static Air Pressure Difference"
ANSI/ASTM E1886	"Standard Test Method for Performance of Exterior Windows, Curtain Walls, Doors, and Impact Protective Systems Impacted by Missile(s) and Exposed to Cyclic Pressure Differentials"
ASTM E1996	"Standard Specification for Performance of Exterior Windows, Curtain Walls, Doors and Impact Protective Systems Impacted by Windborne Debris in Hurricanes"
(TAS) 201	"Impact Test Procedures"*
(TAS) 202	"Standard Test Method for Structural Performance of Exterior Windows, Doors, Skylights and Curtain Walls by Uniform Static Air Pressure Difference"
(TAS) 203	"Criteria for Testing Products Subject to Cyclic Wind Pressure Loading"*

* Published in the "Florida Building Code"

UL Certification Directory: ZHLL.R21744 – Products for Use in Windstorm-rated Assemblies

Certifications to meet assembly requirements are done in conjunction with doors from ASSA ABLOY Group companies CECO DOOR and CURRIES.

ASTM E330	"Standard Test Method for Structural Performance of Exterior Windows, Doors, Skylights and Curtain Walls by Uniform Static Air Pressure Difference"
ANSI/ASTM E1886	"Standard Test Method for Performance of Exterior Windows, Curtain Walls, Doors, and Impact Protective Systems Impacted by Missile(s) and Exposed to Cyclic Pressure Differentials"
ASTM E1996	"Standard Specification for Performance of Exterior Windows, Curtain Walls, Doors and Impact Protective Systems Impacted by Windborne Debris in Hurricanes"
AAMA/WDMA/CSA 101/1.S.2/A440	"Standard/Specification for Windows, Doors, and Unit Skylights"
FEMA Publication 320	"Taking Shelter From the Storm: Building a Safe Room for Your Home or Small Business", investigated with respect to impact and pressure requirements only.
FEMA Publication 361	"Design and Construction Guidance for Community Safe Rooms", investigated with respect to impact and pressure requirements only
ICC 500	"ICC/NSSA Standard for the Design and Construction of Storm Shelters", investigated with respect to impact and pressure testing. Minimum missile impact speeds vary with the design wind speed desired for a particular product. The information below correlates design wind speed to the minimum missile speeds as discussed in Table 305.1.1 of ICC 500

Copyright © 2007-2015, Sargent Manufacturing Company, an ASSA ABLOY Group company. All rights reserved. Reproduction in whole or in part without the express written permission of Sargent Manufacturing Company is prohibited.

90640:N 12/08/15

STC Acoustic Door System

11 Line Bored Lock

SARGENT®

ASSA ABLOY

STC Acoustical Door Systems from Security Metal Products

SARGENT 11 Line bored locks are part of the STC Acoustical Door Systems from ASSA ABLOY Group brand Security Metal Products (SMP). The STC Acoustical Door Systems are the perfect choice for any room where sound transmission needs to be kept to a minimum. This solution encompasses door, frame, sound seals and threshold and lock. All door systems use standard locks. The STC55 requires a special version of the 11 Line lock.

To order the 11 Line bored lock for use with the STC55 door system, include the STC prefix in the 11 Line order string and specify the B or O rose only. With this prefix, it will be configured for use with the Acoustical Door System.

To learn more about SMP and the STC Acoustical Door Systems, please visit www.secmet.com

Functions

11 Line Bored Lock

Single Cylinder Functions

04 Storeroom or Closet

11G04

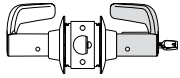

- Deadlocking latch
- Latchbolt by lever inside or key outside
- Outside lever rigid at all times
- ANSI F86

05 Entrance or Office

11G05

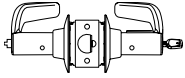

- Deadlocking latch
- Latchbolt by either lever unless outside lever is locked by push/turn button in inside lever
- Turn button must be released manually
- Key only retracts latchbolt when outside lever is locked
- ANSI F81

24 Entrance or Office

11G24

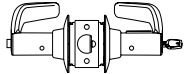

- Deadlocking latch
- Latchbolt by either lever unless outside lever is locked by push button in inside lever
- Push button released by key or turning inside lever
- Closing door does not unlock outside lever or release button
- ANSI F82

37 Classroom

11G37

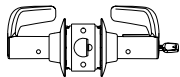

- Deadlocking latch
- Latchbolt by either lever unless outside lever is locked by key
- Key in outside lever locks or unlocks outside lever
- Inside lever always operative
- ANSI F84

44 Service Station

11G44

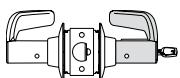

- Deadlocking latch
- Latchbolt by either lever unless outside lever is locked by push button of inside lever
- Key retracts latchbolt when outside lever is locked
- Push button will not depress unless door is in closed position
- Push button released by turning inside lever or by key in outside lever unless push button is fixed in locked position by turning coin slot in inside lever
- ANSI F92

50 Hotel, Dormitory or Apartment

11G50

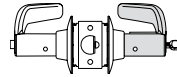

- Deadlocking latch
- Latchbolt by key outside and lever inside
- Outside lever always rigid
- Depressing push button when door is closed shuts out all keys except emergency key and projects visual occupancy indicator in cylinder face
- Push button will not depress unless door is closed in position
- Push button released by turning inside lever automatically reactivating all keys and retracting visual occupancy indicator
- Lock out key fixes push button in locked position, shutting out all keys except emergency
- Lock out key provided only when ordered separately (14-0299)
- See option page for restrictions to 50 function
- ANSI F93

54 Corridor

11G54

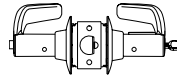

- Deadlocking latch
- Latchbolt by either lever unless outside lever is locked by push button inside or key outside
- Rotating inside lever releases button
- Push button will not depress unless door is in closed position
- Key outside locks or unlocks outside lever and releases inside button
- ANSI F90

Hand

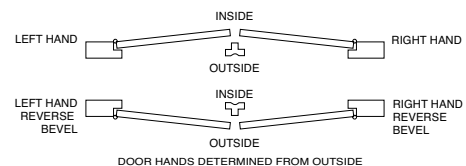

Functions

11 Line Bored Lock

Double Cylinder Functions

16 Classroom, Security, Apartment, Exit, Privacy

11G16

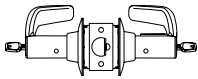

- Deadlocking latch
- Latchbolt by either lever unless outside lever is locked by key in inside lever
- Key in outside lever only retracts latchbolt when outside lever is locked
- **ANSI F88**

◆ 17 Utility, Asylum or Institutional

11G17

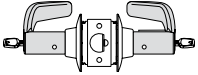

- Deadlocking latch
- Both levers rigid at all times
- Latchbolt by key either side
- **ANSI F87**

◆ 30 Communicating

11G30

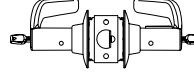

- Deadlocking latch
- Latchbolt by either lever
- Key in either lever locks or unlocks its own lever only
- **ANSI F80**

38 Classroom Security Intruder

11G38

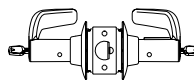

- Deadlocking latch
- Latchbolt by either lever unless outside lever is locked by key
- Key in either lever locks or unlocks outside lever
- When inside key locks the outside lever only the inside key can unlock the outside lever. The outside key only retracts the latchbolt until outside lever is unlocked by inside key
- Inside lever always operable
- Locking direction indicated on inside rose standard with this function. Available on rose designs E, L and O

Non-Cylinder Functions

13 Exit

11G13

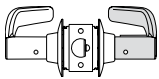

- Deadlocking latch
- Latchbolt by inside lever
- Outside lever rigid at all times
- **ANSI F89**

15 Passage

11U15

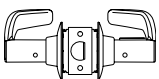

- Latchbolt by either lever
- **ANSI F75**

15-3 Exit or Communicating

11G15-3

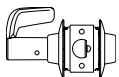

- Deadlocking latch
- Blank rose outside
- Latchbolt by lever inside
- Minimum clearance of 1-1/4" (32mm) required between doors

65 Privacy/Bathroom

11U65

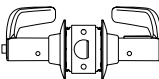

- Latchbolt by either lever unless outside lever is locked by push button in inside lever
- Turning inside lever or closing door releases button
- Emergency button in outside lever unlocks, with use of a blade screw driver in outside lever and releases inside button
- Emergency key supplied only when ordered separately (14-0057)
- **ANSI F76**

68 Hospital Privacy

11G68

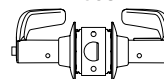

- Latch by either lever unless outside lever is locked by push button in inside lever
- Turning inside lever or closing door releases button
- Rotating thumbturn in outside lever unlocks the outside lever and releases the inside button
- Not available in the "J" lever design

93 Single Lever Pull

11U93

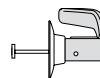

- For wood or custom hollow metal doors
- Lever and rose attached by through-bolt and four surface applied screws (hidden)
- Requires 5/16" (8mm) diameter hole

94 Double Lever Pull

11U94

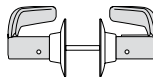

- For wood or custom hollow metal doors
- Lever and rose both sides joined by one through-bolt and four surface applied screws each side (hidden)
- Requires special door preparation – see template

94-2 Double Lever Pull

11U94-2

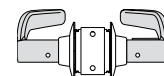

- For 161 and ANSI A115.2 prepared doors
- Lever and rose both sides joined by aligning tube and latchbolt tube
- Dummy latch plate

Shaded lever indicates it is rigid at all times.

◆ Use only on rooms with more than one exit.

Function Conversion Chart and Retrofit Options

11 Line Bored Lock

SARGENT®

ASSA ABLOY

11 LINE FUNCTION CONVERSION CHART

FUNCTION	INSIDE LEVER	INSIDE COLLAR	INSIDE SLEEVE	LATCH	BEARING	OUTSIDE SLEEVE	OUTSIDE COLLAR	OUTSIDE LEVER
04: Storeroom/Closet	Passage lever	11-0031	11-2151	11-2106(B)	11-2899	11-2009	(On sleeve)	Cylinder lever
05: Entrance/Office	Pushbutton lever	11-0031	11-2152	11-2106(B)	11-2899	11-2009	(On sleeve)	Cylinder lever
13: Exit	Passage lever	11-0031	11-2151	11-2106(B)	11-2899	11-2010	(On sleeve)	Passage lever
15: Passage	Passage lever	11-0031	11-2153	11-2107(A)	11-2899	11-2153	11-0031	Passage lever
15-3: Exit or Communicating	Passage lever	11-0031	11-2153	11-2106(B)	11-2899	None - See Parts Book	None - See Parts Book	None - See Parts Book
16: Classroom Security/ Apartment	Cylinder lever	(On sleeve)	11-2011	11-2106(B)	11-2899	11-2009	(On sleeve)	Cylinder lever
17: Utility/Asylum	Cylinder lever	(On sleeve)	11-2013	11-2106(B)	11-2899	11-2012	(On sleeve)	Cylinder lever
24: Entry	Pushbutton lever	11-0031	11-2157	11-2108(K)	11-2899	11-2909	(On sleeve)	Cylinder lever
30: Communicating	Cylinder lever	(On sleeve)	11-2014	11-2106(B)	11-2899	11-2015	(On sleeve)	Cylinder lever
37: Classroom	Passage lever	11-0031	11-2153	11-2106(B)	11-2899	11-2014	(On sleeve)	Cylinder lever
38: Classroom Security	Cylinder lever	(On sleeve)	11-2011	11-2106(B)	11-2899	11-2017	(On sleeve)	Cylinder lever
44: Service Station	Pushbutton lever	11-0031	11-2154	11-2110(D)	11-2899	11-2009	(On sleeve)	Cylinder lever
50: Hotel/Motel	Pushbutton lever	11-0031	11-2155	11-2110(D)	11-2899	11-2016	(On sleeve)	Cylinder lever
54: Dormitory	Pushbutton lever	11-0031	11-2156	11-2110(D)	11-2899	11-2017	(On sleeve)	Cylinder lever
65: Privacy/Bathroom	Pushbutton lever	11-0031	11-2156	11-2111(C)	11-2899	11-2055	(On sleeve)	Cylinder lever

Note: Functions 93, 94 and 94-2 are of different construction. See Parts Pages for parts and construction

SARGENT 6010 Replacement Kit — for 7600 Integra Lock

Large Rose and Cover Plate



Sub Front



800 Strike



808 Strike



"L" Rose
3-1/2" (89mm) diameter
Order: 11-2446 x finish



Cover Plate
3" x 12" (76mm x 305mm)
Order: 06-0037 x finish
(2 qty. required)

- For installation of standard backset 11 Line lock replacing old 7600 Integra locks in wood doors
- Finishes: 03, 04, 10, 10B, 10BE, 10BL, 15, 20D, 26 and 26D
- Replacement Kit consist of:

Quantity	Item	Item Number	Size
1	Sub Front	08-0562 x finish (108mm x 32mm)	4-1/4" x 1-1/4"
1	Strike (must specify 800 or 808)	800 x finish (with screws) 808 x finish (with screws)	2-3/4" x 1-1/4" x 1-1/4" (70mm x 32mm x 32mm) 4-7/8" x 1-1/8" x 1-1/4" (121mm x 29mm x 32mm)
1	Strike Box	08-0055 77-1141	For 800 Strike For 808 Strike (ANSI)
2	Sub Front Screws	01-5001	#10-24 x 3/4" (19mm)

Screws
Order: 01-2037 x finish
(8 qty. required)

- To cover existing holes on face of door
- "L" roses can be ordered with the 11 Line lock
Example: 11G05 x LB x 26D
- Cover plate, if required, must be ordered separately

Note: Strikes will not retrofit for strikes 4-1/4" x 1-1/8" x 1-1/4" (108mm x 29mm x 32mm).
Lock will not retrofit for lock front plate size 5-1/4" x 1-1/4" (133mm x 32mm)
36-7600 locks

Copyright © 2007-2015, Sargent Manufacturing Company, an ASSA ABLOY Group company. All rights reserved. Reproduction in whole or in part without the express written permission of Sargent Manufacturing Company is prohibited.

90640N 12/08/15

Lever and Rose Designs

11 Line Bored Lock

Lever & Rose Designs

OL Design

- Rose: O - Wrought
- Lever: L - Cast

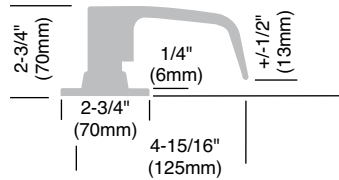

Note: Any rose and lever on this page can be combined to suit individual taste

LJ Design

- Rose: L - Wrought
- Lever: J - Cast

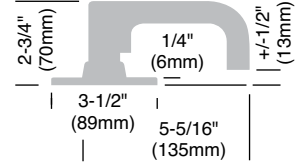

Note: Lever projections shown are for 1-3/4" (44mm) doors and will vary by door thickness

EB Design

- Rose: E - Wrought
- Lever: B - Cast

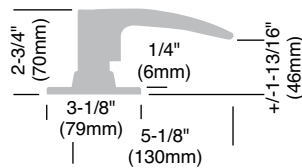
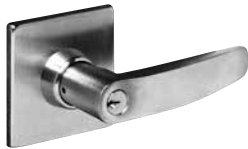

BP Design

- Rose: B - Wrought
- Lever: P - Cast

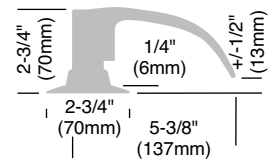

Type 161 Cutout

If weather-stripping, acoustical materials or silencers are used on the door or frame, care must be taken in the installation so that it will not interfere with the ease in which the latchbolt enters the strike

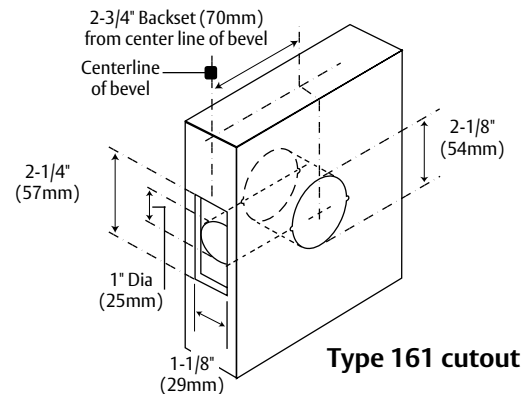

Latches and Strikes

11 Line Bored Lock

SARGENT®

ASSA ABLOY

Latch Assemblies

Part	Code	Functions
Standard 2-3/4" (70 mm) Backset		
11-2106	B	04, 05, 13, 15-3, 16, 17, 30, 37, 38
11-2107	A	15
11-2108	K	24
11-2110	D	44, 50, 54
11-2111	C	65, 68
23- option 3-3/4" (95mm) Backset		
11-2113	B	04, 05, 13, 15-3, 16, 17, 30, 37, 38
11-2114	A	15
11-2115	K	24
11-2117	D	44, 50, 54
11-2118	C	65, 68
25- option 5" (127mm) Backset		
11-2120	B	04, 05, 13, 15-3, 16, 17, 30, 37, 38
11-2121	A	15
11-2122	K	24
11-2124	D	44, 50, 54
11-2125	C	65, 68
41-option 3/4" (19mm) Throw		
08-2517	—	04, 05, 15, 15-3, 16, 37

Note: Code letter stamped on inside corner of latch front identifies function(s) compatible with the latch assembly

800 Curved Lip Strike Standard

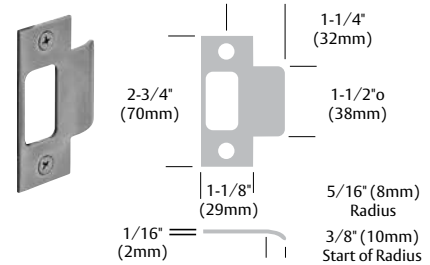

- Furnished standard with 1-1/4" (32mm) curved lip, measured from center of strike screw holes to end of lip
- Lip lengths: 1-1/8" (29mm) to 2-7/8" (73mm) in 1/4" (6mm) increments only
- To order 800 strike with lock, specify lock and lip length
Example: 11G05 x LL x 10B x 1-3/4" (44mm) lip
- To order strike separately, specify 800 strike x finish x lip length
- Wrought box strike, 08-0055, provided standard
- Finishes: 03, 04, 09, 10, 10B, 10BE, 14, 15, 20D, 32, 32D

23- or 25- Option: Extended Backsets



- 11 Line latches are available with extended backsets:
23- option 3-3/4" (95mm)
25- option 5" (127mm)
- To order with lock, specify 23- or 25- option and backset at end of order
Example: 23-11G05 x OL x 10B x 3-3/4" (95mm) backset
- To order latch separately, specify: Part number x finish (see table above)
- Finishes: 03, 04, 09, 10, 10B, 10BE, 15, 20D, 26, 26D

41- Option: 3/4" (19mm) Throw for Pairs of Doors



- For use on pairs of doors
- Guarded latchbolts listed by Underwriters Laboratories for use on 3-hour A Label pairs of doors
- Available functions: 11G04, 11G05, 11G15, 11G15-3, 11G16 and 11G37
- To order with lock, specify 41- option
Example: 41-11G05 x OB x 10B
- 2-3/4" (70mm) Backset only
- Requires 78° of lever rotation to retract latchbolt
- Please note: special door prep required for 41- option — refer to template
- Finishes: 03, 04, 09, 10, 10B, 10BE, 15, 20D, 26, 26D

28- Option: 808 ANSI Curved Lip Strike

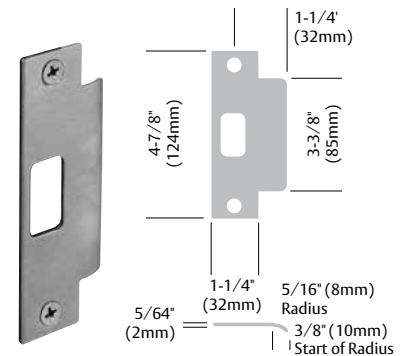

- Conforms to ANSI standard 115.2
- Furnished standard with 1-1/4" (32mm) curved lip, measured from center of strike screw holes to end of lip
- Lip lengths: 1-1/8" (29mm), 1-1/4" (32mm) and 1-3/8" (35mm) to 2-7/8" (73mm) in 1/4" (6mm) increments only
- To order 808 strike with lock, specify 28- option with lock and lip length
Example: 28-11G05 x LL x 10B x 1-3/4" (44mm) lip
- To order strike separately, specify 808 strike x finish x lip length
- Wrought box strike not provided, order separately as 77-1141
- Finishes: 03, 04, 09, 10, 10B, 10BE, 15, 20D, 32, 32D

Copyright © 2007-2015, Sargent Manufacturing Company, an ASSA ABLOY Group company. All rights reserved. Reproduction in whole or in part without the express written permission of Sargent Manufacturing Company is prohibited.

90640N 12/08/15

Mechanical Options

11 Line Bored Lock



Mechanical Options:

Backset Options	23-	3-3/4" Backset x 2-1/4" x 1-1/8" Front
	25-	5" Backset x 2-1/4" x 1-1/8" Front
Strike	28-	#808 Strike; Standard lip length 1-1/4". Other lip lengths must be specified; available lengths are 1-1/8", 1-3/8", 1-5/8", 1-7/8", 2-1/8", 2-3/8", 2-5/8" & 2-7/8"
Thick Doors	31-	Special order for doors over 2" thick, specify as a 31- option, consult factory for lead time & pricing
Security Fasteners	36-	Six lobe security head screws
	37-	Spanner head screws
3/4" Throw	41-	3/4" (19mm) Latch throw (04, 05, 15, 15-3, 16 and 37 functions only) 78° lever rotation required
Lead Lined	74-	Lead Lining I/S rose, O/S rose, and Latch Tube
Tactile Warning Options	75-	Tactile Warning – Handicap warning milled on backside of inside lever
	76-	Tactile Warning – Handicap warning milled on backside of outside lever
	77-	Tactile Warning – Handicap warning milled on backside of both levers
	85-	Tactile Warning – Abrasive coating on inside lever
	86-	Tactile Warning – Abrasive coating on outside lever
	87-	Tactile Warning – Abrasive coating on both levers
Finish Protection	SG-	MicroShield® antimicrobial clear powder coat (Not available with 10B Finish)
Additional Security	SL-	High Security Lever attachment (Patent Pending) Available for keyed functions
Acoustical Door Systems	STC	STC 55 Acoustical Door System (see page 2)
Box Strike	WBS-	Wrought Box Strike

Cylinder Options

11 Line Bored Lock



Cylinder Options:

Conventional Cylinder	-	SARGENT Conventional Cylinders supplied Standard (nomenclature not required)
Degree Key System	DG1-	SARGENT Degree Key System Level 1
	DG1-21*	Degree Level 1 Construction Master Keying
	DG1-60-	Degree Level 1 Removable Disposable Construction Core
	DG1-63-	Degree Level 1 Removable Core
	DG1-64	Degree Level 1 Removable Construction Keyed LFIC
	DG1-65*	Degree Level 1 Unassembled/Uncombined Core
	DG2-*	SARGENT Degree Key System Level 2
	DG2-21*	Degree Level 2 Construction Master Keying
	DG2-65*	Degree Level 2 Unassembled/Uncombined Core
	DG2-60-*	Degree Level 2 Removable Disposable Construction Core
	DG2-63-*	Degree Level 2 Removable Core
	DG2-64*	Degree Level 2 Removable Construction Keyed LFIC
	DG3-*	SARGENT Degree Key System Level 3
	DG3-21-*	Degree Level 3 Construction Master Keying
	DG3-60-*	Degree Level 3 Removable Disposable Construction Core
DG3-63-*	Degree Level 3 Removable Core	
DG3-64*	Degree Level 3 Removable Construction Keyed LFIC	
Signature Key System	10-*	SARGENT Signature Key System
	10-21-*	SARGENT Signature Construction Key System (Lost Ball)
Signature Removable Core	10-63-*	SARGENT Signature Removable Core Cylinder
XC- Key System	11-*	XC Key System (not available with other Key Systems, unless specified)
	11-21-*	XC- Construction Key System (Lost Ball)
XC- Large Format Interchangeable Core (Removable Core)	11-60-*	Lock to accept XC- Permanent Removable Core, Disposable plastic Core-provided
	11-63-*	Lock provided with XC- Removable Core Cylinder – (includes masterkeying, grand masterkeying)
	11-64-*	Lock provided with Keyed construction core to accept XC- Removable Permanent Core (ordered separately)
XC- Small Format Interchangeable Cores	11-70-7P-*	Lock to accept XC- SFIC (7-Pin) XC- Permanent Cores, plastic disposable core provided
	11-72-7P-*	Lock to accept XC- SFIC (7-Pin Keyed Construction Core provided) cylinder Permanent Core ordered separately
	11-73-7P-*	Lock supplied with XC- Small Format 7-Pin interchangeable core (includes masterkeying, grand masterkeying)
	11-65-73-7P-*	Lock provided to accept XC- Uncombined 7-Pin SFIC (Permanent) Core - (packed loose)

Note: Cylinder Options continued on the following page

* Options not available with 11G50

Copyright © 2007-2015, Sargent Manufacturing Company, an ASSA ABLOY Group company. All rights reserved. Reproduction in whole or in part without the express written permission of Sargent Manufacturing Company is prohibited.

Cylinder Options

11 Line Bored Lock

SARGENT®

ASSA ABLOY

Cylinder Options:

Construction Key Systems	21-*	SARGENT Lost Ball Construction Keying for Conventional, XC and Signature Series (N/A with 63- or 73-)
	22-*	SARGENT Construction Split Key System for Conventional Cylinders (existing systems only) (N/A with 10-, 11-, 63- or 73-)
Large Format Interchangeable Core (Removable Core)	60-*	Lock to accept SARGENT Permanent Removable Core, Disposable plastic Core provided (Permanent Cores ordered separately)
	63-*	Lock provided with Removable Core Cylinder (Includes masterkeying, grand masterkeying)
	64-*	Lock provided with Keyed construction core to accept Removable Permanent Core (ordered separately)
Small Format Interchangeable Cores	70-*	Lock to accept 6- or 7-Pin SFIC Permanent Cores, plastic disposable core provided
	72-*	Lock to accept 6- or 7-Pin SFIC (Keyed Construction Core provided) Cylinder (Permanent Core ordered separately)
	73-*	Lock supplied with 6-Pin SFIC (Includes masterkeying, grand masterkeying)
	65-73-*	Lock provided to accept Uncombined 6-Pin SFIC (Permanent) Core - (packed loose for field keying)
	65-73-7P-*	Lock provided to accept Uncombined 7-Pin SFIC (Permanent) Core - (packed loose for field keying)
	73-7P-*	Lock supplied with Small Format 7-Pin Interchangeable Core (includes masterkeying, grand masterkeying)
Keso & Keso F1	80-*	Lock to accept Keso and Keso F1 cylinders - no cylinders provided
	82-*	Lock provided with SARGENT Keso Security Cylinder
	F1-82-*	Lock provided with SARGENT Keso F1 Security Cylinder (Patented)
Bump Resistant	BR-	Bump Resistant Cylinder (available with Conventional & Conventional XC Cylinders only)
Less Cylinder	LC-	Lock supplied less Cylinder
Schlage Keyways	SC-*	Schlage C keyway cylinder, 0 bitted
	SE-*	Schlage E keyway cylinder, 0 bitted
Accepts Schlage Cylinders	30-*	Lever to accept Schlage Cylinder-Cylinder is not provided
	SF-*	L Lever to accept Medeco KeyMark Large Format Interchangeable and Schlage Full Size Interchangeable Core (supplied less Cylinder, but with tailpiece needed)
ASSA V-10** (See note below)	VC-	Lock provided to accept ASSA V-10 Interchangeable Core Cylinders. V-10 cylinders are available from ASSA, Inc @ 800-235-7482

* Options not available with 10G50

** To use ASSA V-10 (VA & VS) cylinders with the 11 Line Lock, specify (LC-) less cylinder option and the lock will accept VA or VS cylinders. V-10 cylinders are available from ASSA, Inc. @ 800-235-7482

11-0138 Installation Wrench



- Provided with each lock

14-0299 Lockout Key



- For hotel function only
- Order separately

01-4530 6 Lobe Security Tool (T-20)



- Two, 6 Lobe security lever set screws packed standard with each lock
- One T-20 tool packed per lock

How to Order, Packaging, Finishes and Architectural Specifications

SARGENT®

ASSA ABLOY

11 Line Bored Lock

How to Order

5	11-28-	11G05	B	B	RH	15	Door 3
Quantity	Options*	Lock & Function	Rose	Lever	Hand	Finish	Additional Information
	Available Options Pg 7-8 (Note: 28- for 808 ANSI Strike)	Available Functions Pg 3-4	Available Roses O, E, L & B Pg 2	Available Levers B, J, L & P Pg 2	RH, LH, RHR, LHR Pg 3	Available Finishes Pg 9	Such as Item, Heading Number, Door Number, Keyset

* Multiple Options may be selected

Note: Lock must be centered within door; For locks not centered contact factory

Note: 800 & 808 strikes have a standard 1-1/4 Lip length; all other lengths must be specified; available lengths are 1-1/8", 1-3/8", 1-5/8", 1-7/8", 2-1/8", 2-3/8", 2-5/8" & 2-7/8"

Packaging

28-11G05 x OL
4 lbs. 8 oz./box (2.1 kg)
10 boxes/case

6 Lobe and Spanner Bit Packs

82-3855	6 lobe bit pack 6 bits (Sizes – T8, T9, T10, T15, T20, T25, T27) Requires 9/32" driver
82-3856	Spanner bit pack 5 bits (Sizes – 6, 8, 10, 12, 14) Requires 1/4" driver

Finishes

SARGENT #	Description	BHMA
03	Polished brass, clear coated	605
04	Satin brass, clear coated	606
09	Polished bronze, clear coated	611
10	Satin bronze, clear coated	612
10B	Oxidized bronze, oil rubbed	613
10BE	Dark oxidized satin bronze - Equivalent	613E
10BL	Oxidized satin, bronze, clear coated	614
14	Polished nickel, clear coated	618
15	Satin nickel, clear coated	619
20D	Statuary dark bronze, clear coated	624
26	Polished chrome	625
26D	Satin chrome	626
SG- Option MicroShield® available on 15 & 26D finishes only		
Zinc levers are plated to match BHMA finish.		
Split finishes available. Specify outside finish first.		
Custom colors available, consult factory.		

Suggested Architectural Specifications

2.0 Bored Locksets – 11 Line

- A. All bored lever locks shall be manufactured by SARGENT Manufacturing Co., New Haven, CT.
- B. Locksets shall be able to withstand 3000 inch pounds of torque applied to the locked lever without gaining access.
- C. Locksets shall be cycle tested per ANSI A156.2, 1996, to nine million cycles without any visible lever sag.
- D. Locks required for fire doors shall be listed by Underwriters Laboratories for ratings of A label (3 hours) and less, for doors up to 4'0" (1.2m) x 10'0" (3m) and pairs of doors 8'0" (2.4m) x 10'0" (3m) (with 41-option).
- E. Locksets shall be able to fit a standard 2-1/8" (55 mm) bore without the use of through-bolts. Standard rose size shall be 2-3/4" (70 mm) in diameter.
- F. Lockset levers shall be made of solid material with no plastic fillers.
- G. Latchbolt head shall be one piece stainless steel.
- H. Latchbolt assemblies shall be encased within the lockbody.
- I. Cylinders: SARGENT Signature Series 6-pin cylinders with patented key control.
- J. Locks shall have 2-3/4" (70 mm) backset, standard.
- K. Strikes: Provide wrought boxes and strikes with proper lip length to protect trim but not to project more than 1/8" beyond trim, frame or inactive leaf. Where required, provide open back strike to allow practical and secure operation.
- L. Locksets shall have a ten year limited warranty.

Copyright © 2007-2015, Sargent Manufacturing Company, an ASSA ABLOY Group company. All rights reserved. Reproduction in whole or in part without the express written permission of Sargent Manufacturing Company is prohibited.

90640N 12/08/15

SARGENT Manufacturing Company
100 Sargent Drive
New Haven, CT 06511 USA
800-727-5477
www.sargentlock.com

ASSA ABLOY is the global
leader in door opening solutions,
dedicated to satisfying
end-user needs for security,
safety and convenience